



US00D441468S

(12) **United States Design Patent**  
**Bing**

(10) **Patent No.:** **US D441,468 S**

(45) **Date of Patent:** **\*\* May 1, 2001**

(54) **NIGHT LIGHT VOLATILE DISPENSER**

*Primary Examiner*—Susan J. Lucas  
*Assistant Examiner*—Cynthia E Ramirez

(75) Inventor: **Marcus Ting Hua Bing**, Singapore  
(SG)

(57) **CLAIM**

(73) Assignee: **S. C. Johnson & Son, Inc.**, Racine, WI  
(US)

The ornamental design for a night light volatile dispenser, as shown and described.

(\*\*) Term: **14 Years**

**DESCRIPTION**

(21) Appl. No.: **29/127,146**

FIG. 1 is a front perspective view from above and to one side of the night light volatile dispenser showing the new design. FIG. 2 is a front view of the night light volatile dispenser of FIG. 1.

(22) Filed: **Jul. 31, 2000**

(51) **LOC (7) Cl.** ..... **26-05**

FIG. 3 is a back view of the night light volatile dispenser of FIG. 1.

(52) **U.S. Cl.** ..... **D26/26**

(58) **Field of Search** ..... D26/24, 72, 85,  
D26/118, 121; 362/226, 147, 338

FIG. 4 is a left side view of the night light volatile dispenser of FIG. 1;

(56) **References Cited**

**U.S. PATENT DOCUMENTS**

|            |   |         |               |       |           |
|------------|---|---------|---------------|-------|-----------|
| D. 332,138 | * | 12/1992 | Lonker et al. | ..... | D26/118 X |
| D. 350,209 | * | 8/1994  | Martin        | ..... | D26/26    |
| D. 359,346 | * | 6/1995  | Martin        | ..... | D26/26    |
| D. 397,489 | * | 8/1998  | Alexander     | ..... | D26/118   |
| 5,622,424  | * | 4/1997  | Brady         | ..... | 362/226   |

FIG. 5 is a right side view of the night light volatile dispenser of FIG. 1.

FIG. 6 is a top plan view of the night light volatile dispenser of FIG. 1; and,

FIG. 7 is a right side view of the night light volatile dispenser of FIG. 1.

The broken line showing in FIGS. 2, 5 and 6 is for illustrative purposes only and forms no part of the claimed design.

\* cited by examiner

**1 Claim, 4 Drawing Sheets**

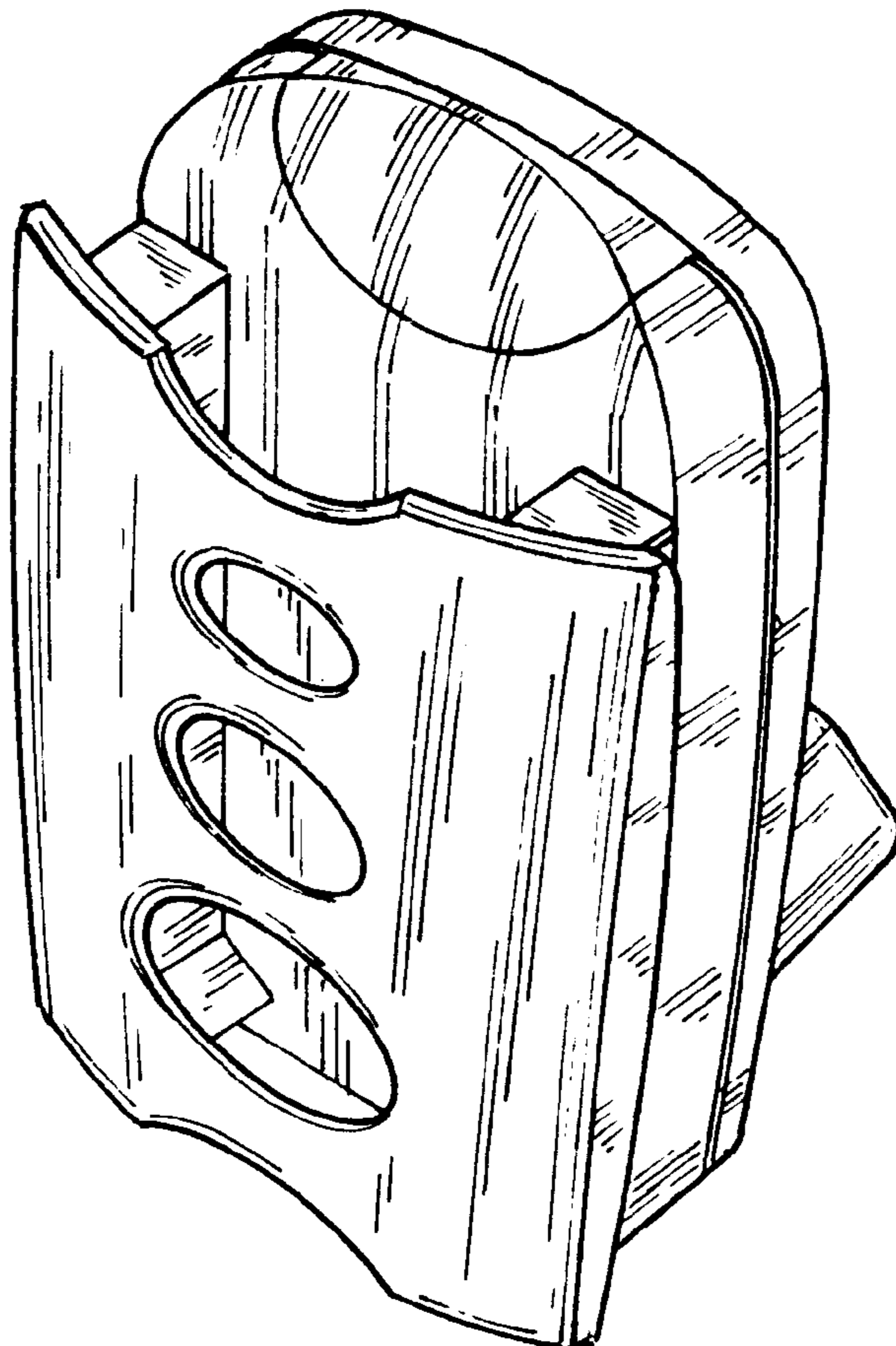

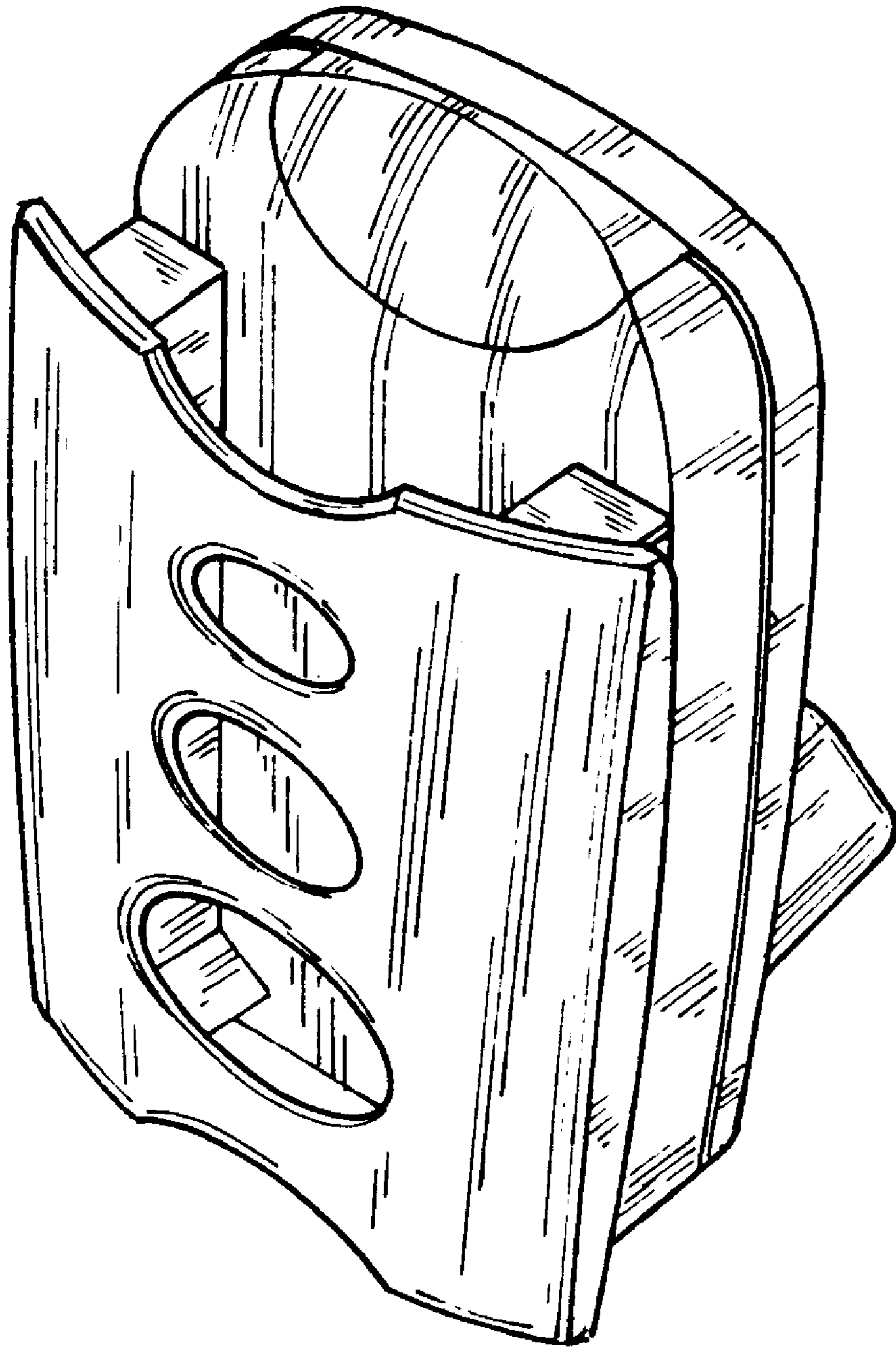

FIG. 1

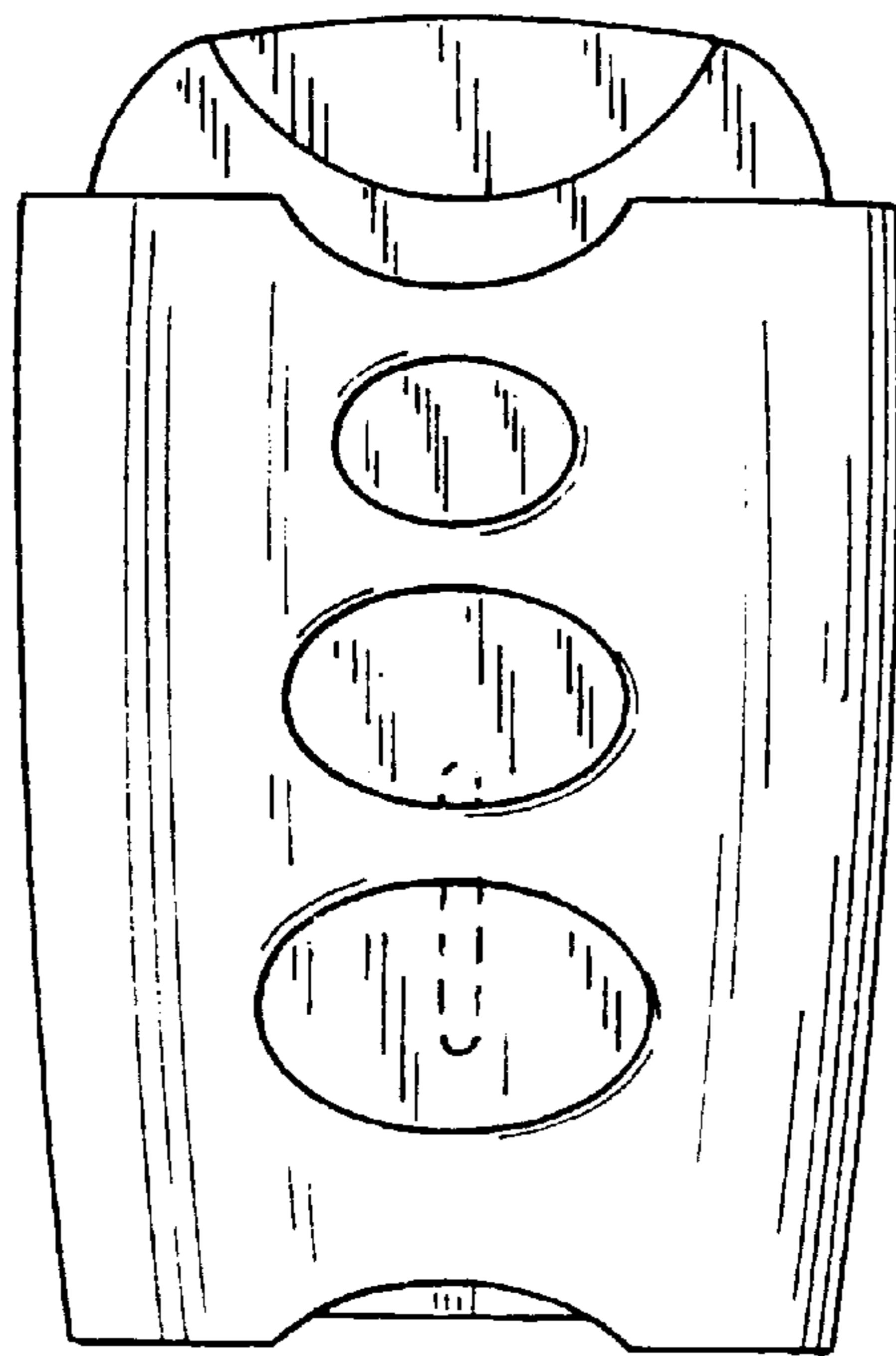

FIG. 2

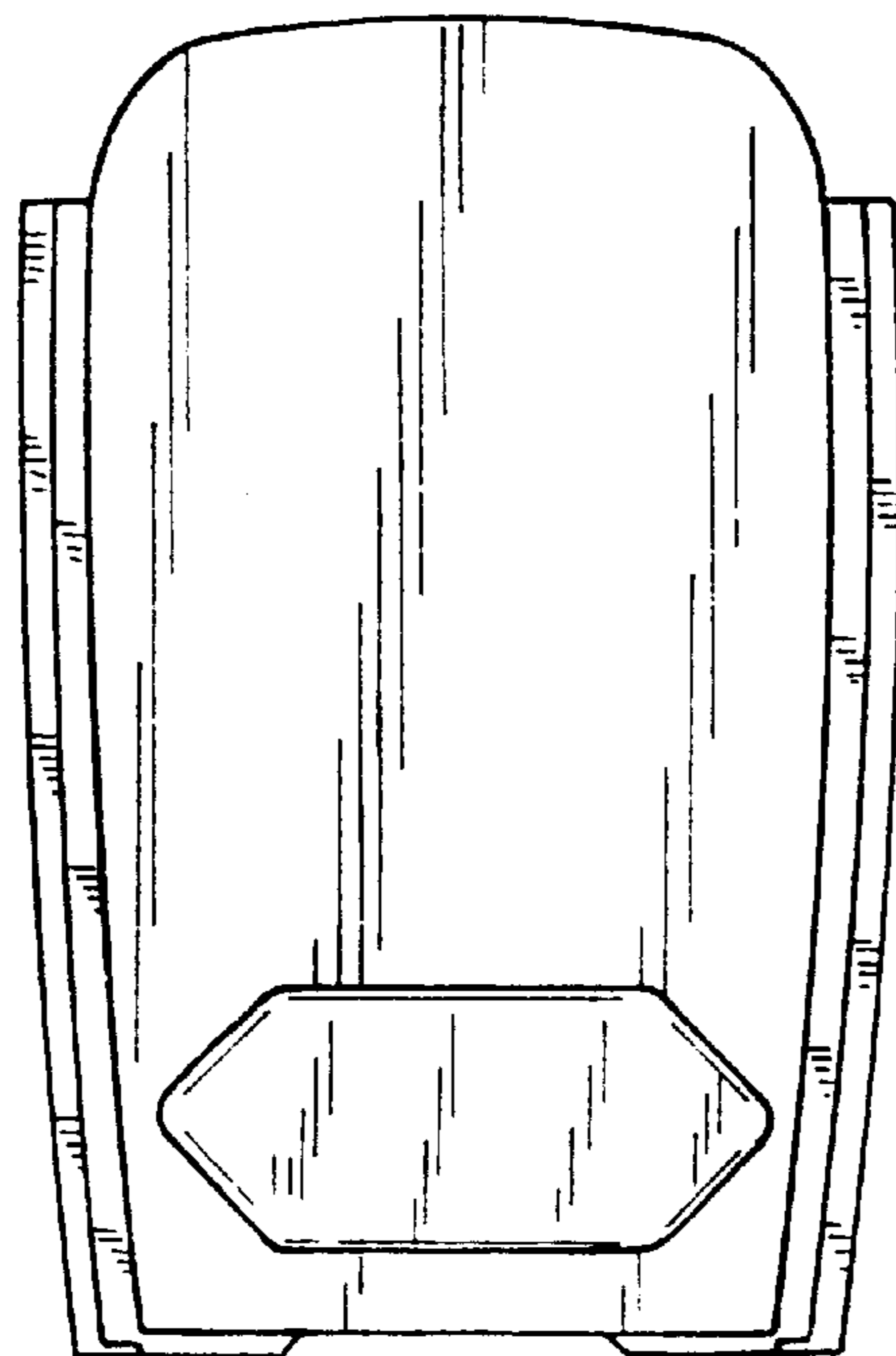

FIG. 3

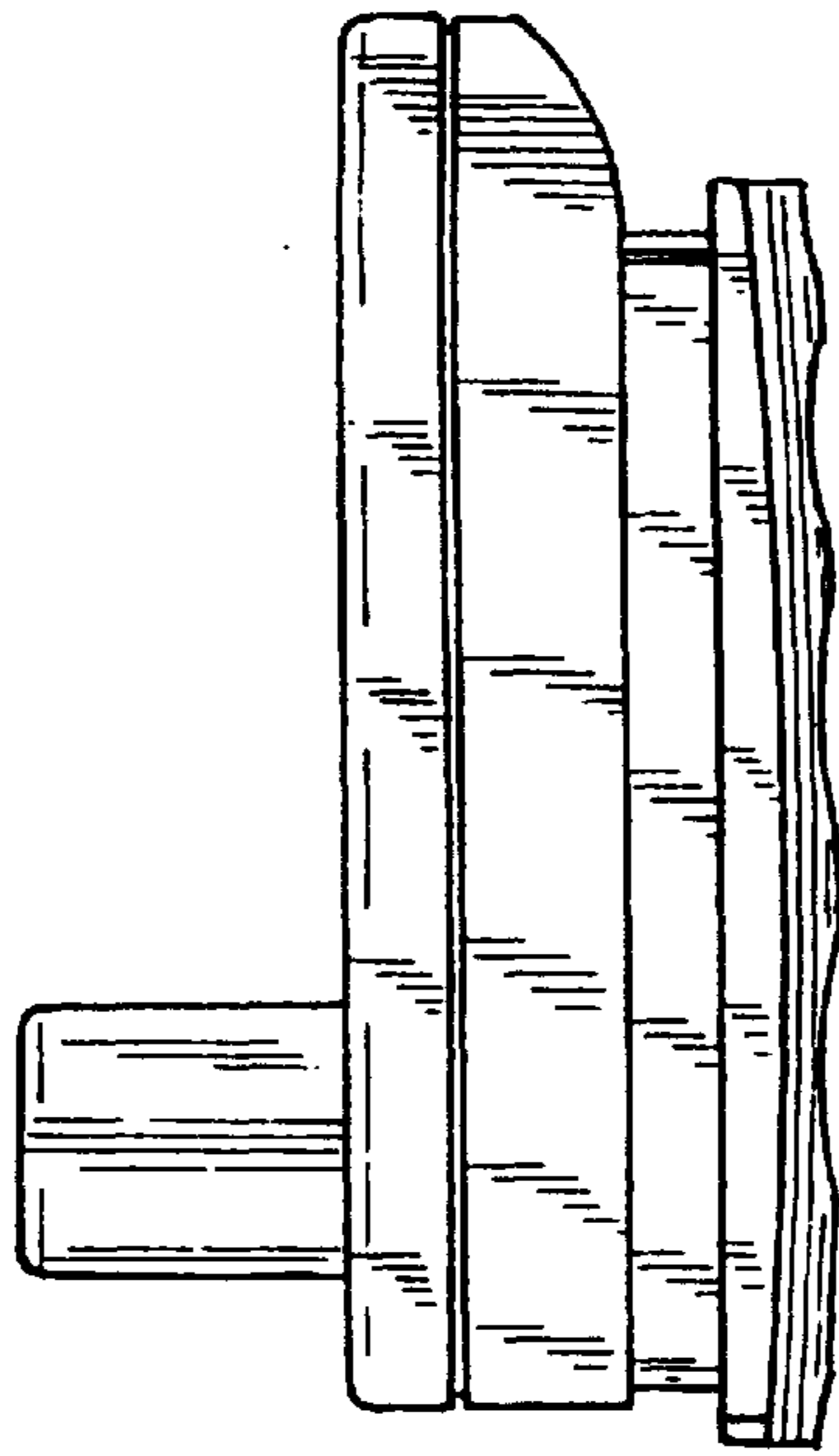

FIG. 4

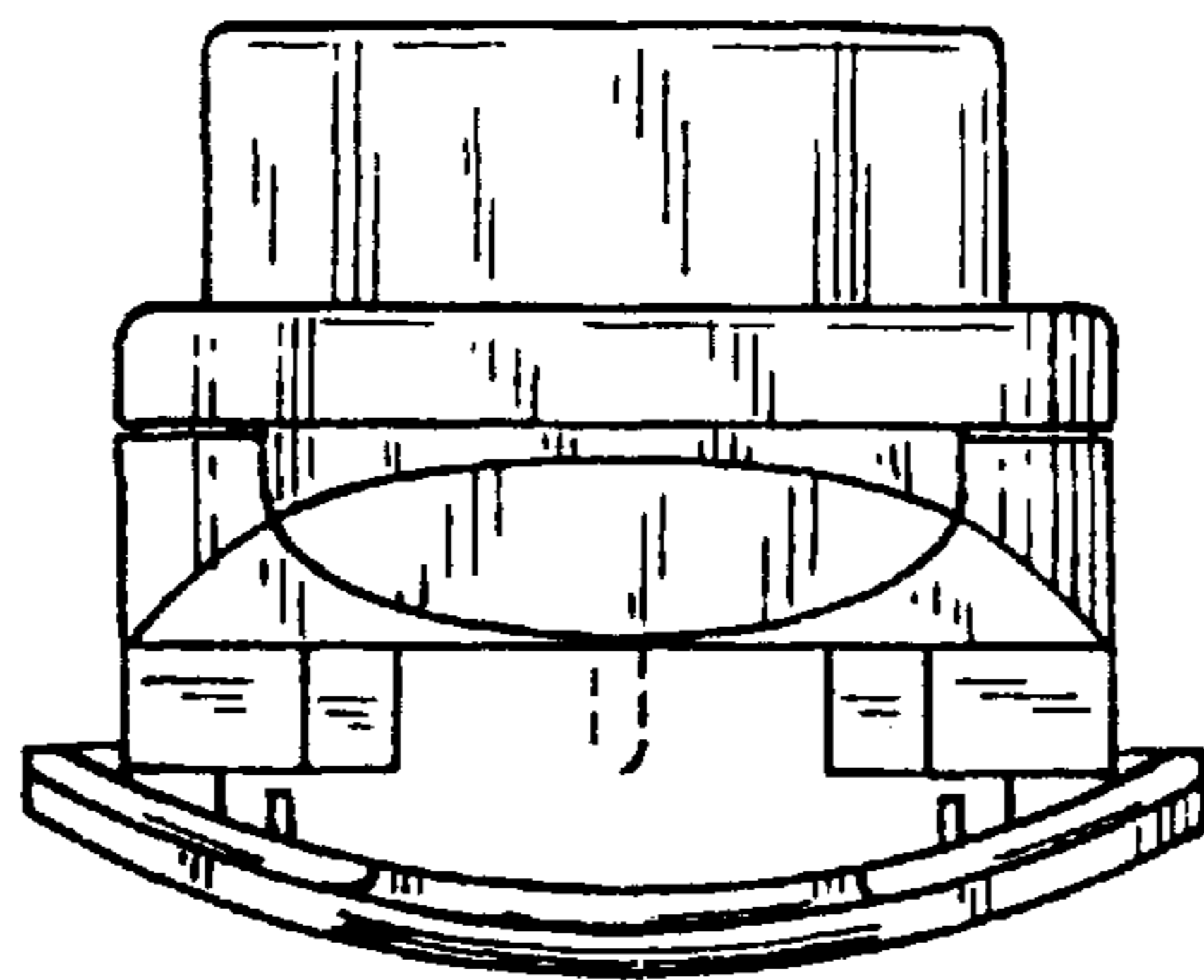

FIG. 5

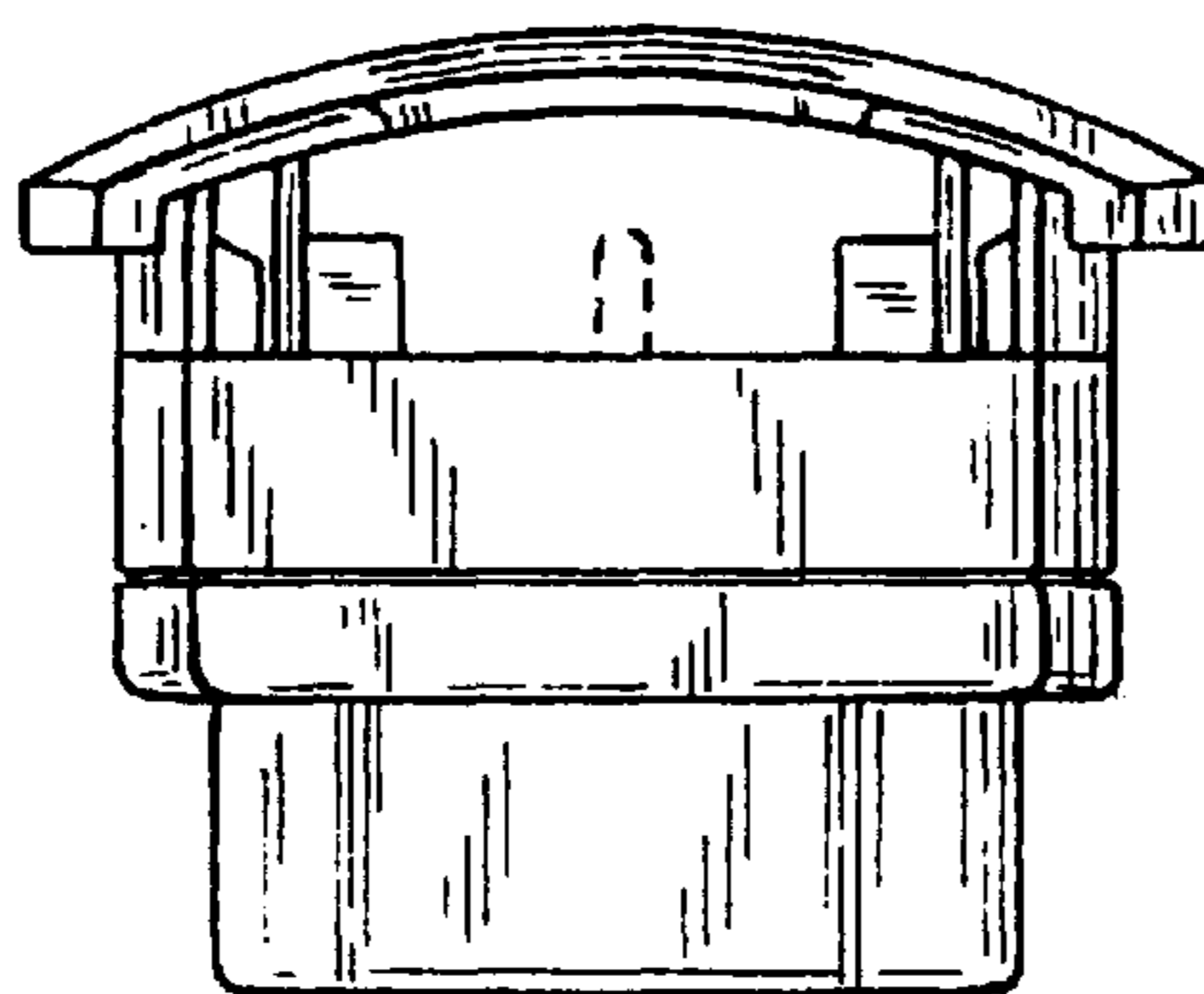

FIG. 6

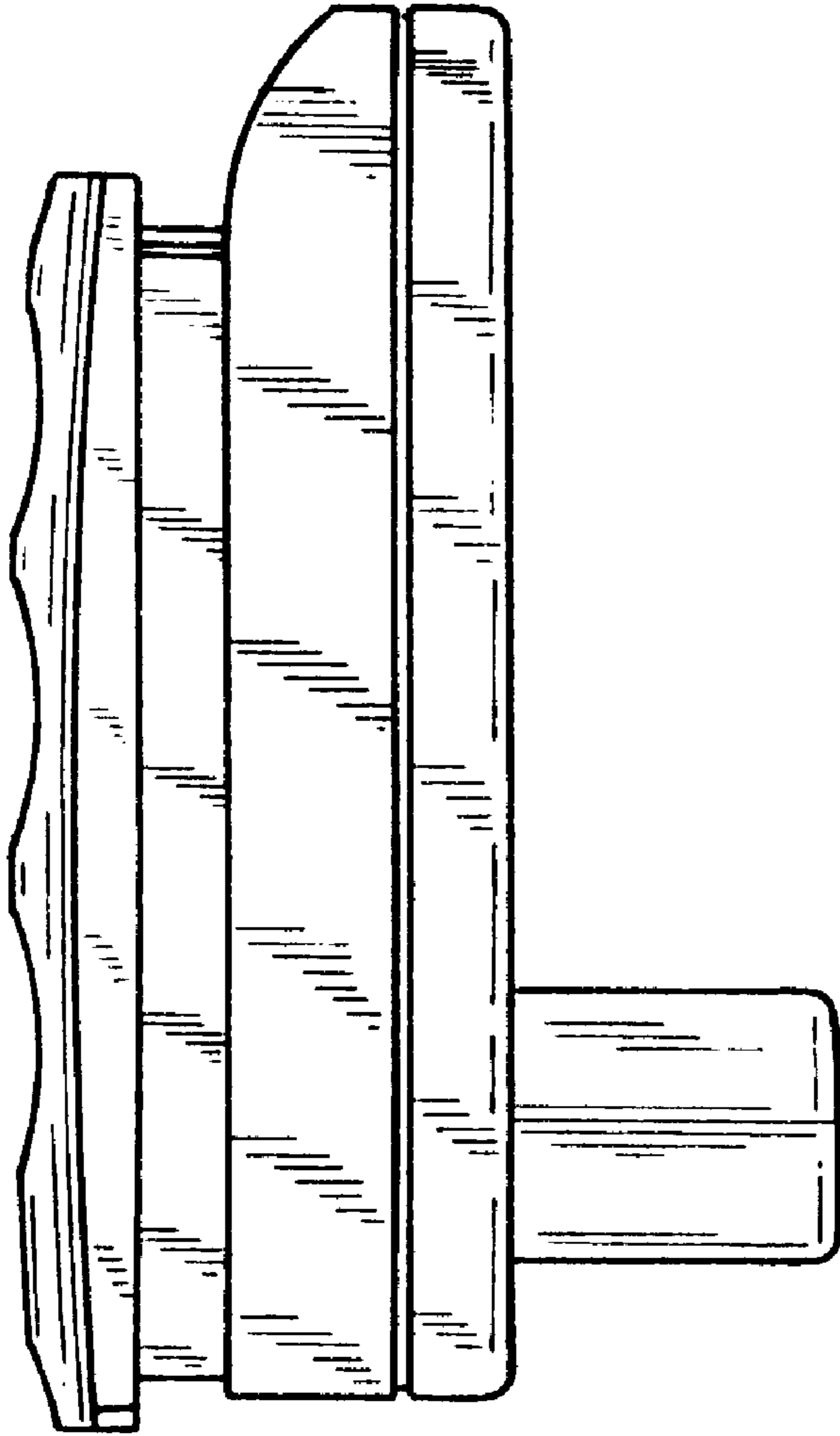

FIG. 7

UNITED STATES PATENT AND TRADEMARK OFFICE  
**CERTIFICATE OF CORRECTION**

PATENT NO. : Des. 441,468 S  
DATED : May 1, 2001  
INVENTOR(S) : Marcus Ting Hua Bing

Page 1 of 1

It is certified that error appears in the above-identified patent and that said Letters Patent is hereby corrected as shown below:

Drawings,

Replace the description of Figs. 5 and 6 with the following:

-- Fig. 5 is a top plan view of the night light volatile dispenser of Fig. 1.

Fig. 6 is a bottom plan view of the night light volatile dispenser of Fig. 1. --

Signed and Sealed this

Twenty-fourth Day of September, 2002

*Attest:*



*Attesting Officer*

JAMES E. ROGAN  
*Director of the United States Patent and Trademark Office*