



US00D441401S

(12) **United States Design Patent**  
**McGarrah**

(10) **Patent No.:** **US D441,401 S**

(45) **Date of Patent:** **\*\* May 1, 2001**

(54) **ELECTRONIC COMMERCE TERMINAL ENCLOSURE WITH BRACKETS**

*Primary Examiner*—Nanda Bondade  
(74) *Attorney, Agent, or Firm*—Ratner & Prestia

(75) **Inventor:** **Robert G. McGarrah**, Brookfield, CT (US)

(57) **CLAIM**

The ornamental design for an electronic commerce terminal enclosure with brackets, as shown and described.

(73) **Assignee:** **USA Technologies, Inc.**, Wayne, PA (US)

**DESCRIPTION**

(\*\*) **Term:** **14 Years**

FIG. 1 is a left front perspective view of an electronic commerce terminal enclosure with brackets showing my new design;

(21) **Appl. No.:** **29/120,874**

FIG. 2 is an enlarged left front perspective view thereof;

(22) **Filed:** **Mar. 28, 2000**

FIG. 3 is a right rear perspective view thereof;

(51) **LOC (7) Cl.** ..... **20-01**

FIG. 4 is a front elevational view thereof;

(52) **U.S. Cl.** ..... **D20/8**

FIG. 5 is a rear elevational view thereof;

(58) **Field of Search** ..... D20/1-9; 194/344, 194/346, 350, 205, 207; 221/92, 96-97, 155, 255, 277

FIG. 6 is a left side elevational view thereof;

FIG. 7 is a right side elevational view thereof;

FIG. 8 is a top plan view thereof;

FIG. 9 is a bottom plan view thereof; and,

FIG. 10 is an exploded right rear perspective view thereof showing brackets removed for clarity of illustration.

The broken line showing on FIGS. 1-10 is for illustrative purposes only and forms no part of the claimed design.

(56) **References Cited**

**U.S. PATENT DOCUMENTS**

- D. 359,764 \* 6/1995 King ..... D20/4
- D. 400,928 \* 11/1998 Waffensmith et al. .... D20/8
- 6,014,594 \* 1/2000 Heidel et al. .... 194/205 X

\* cited by examiner

**1 Claim, 9 Drawing Sheets**

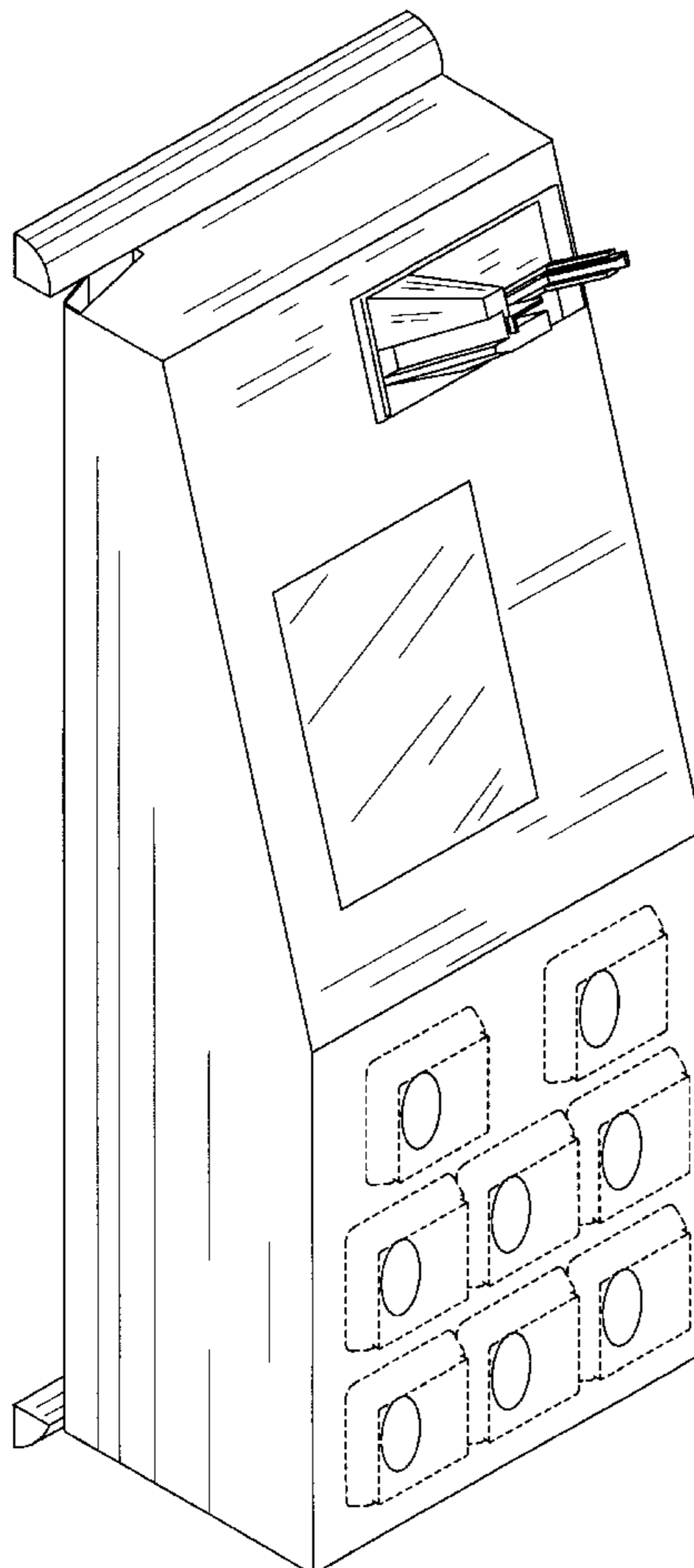

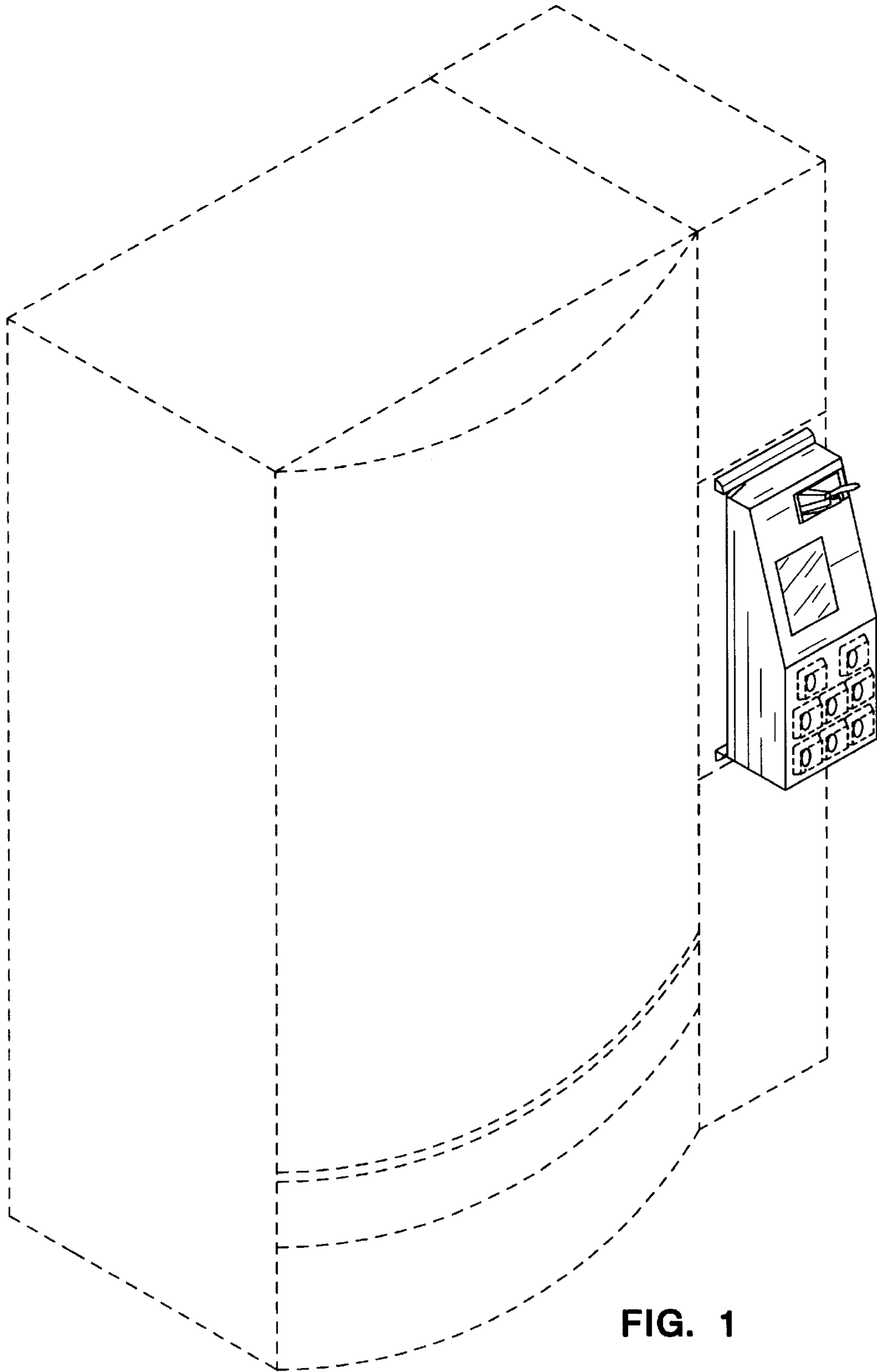

FIG. 1

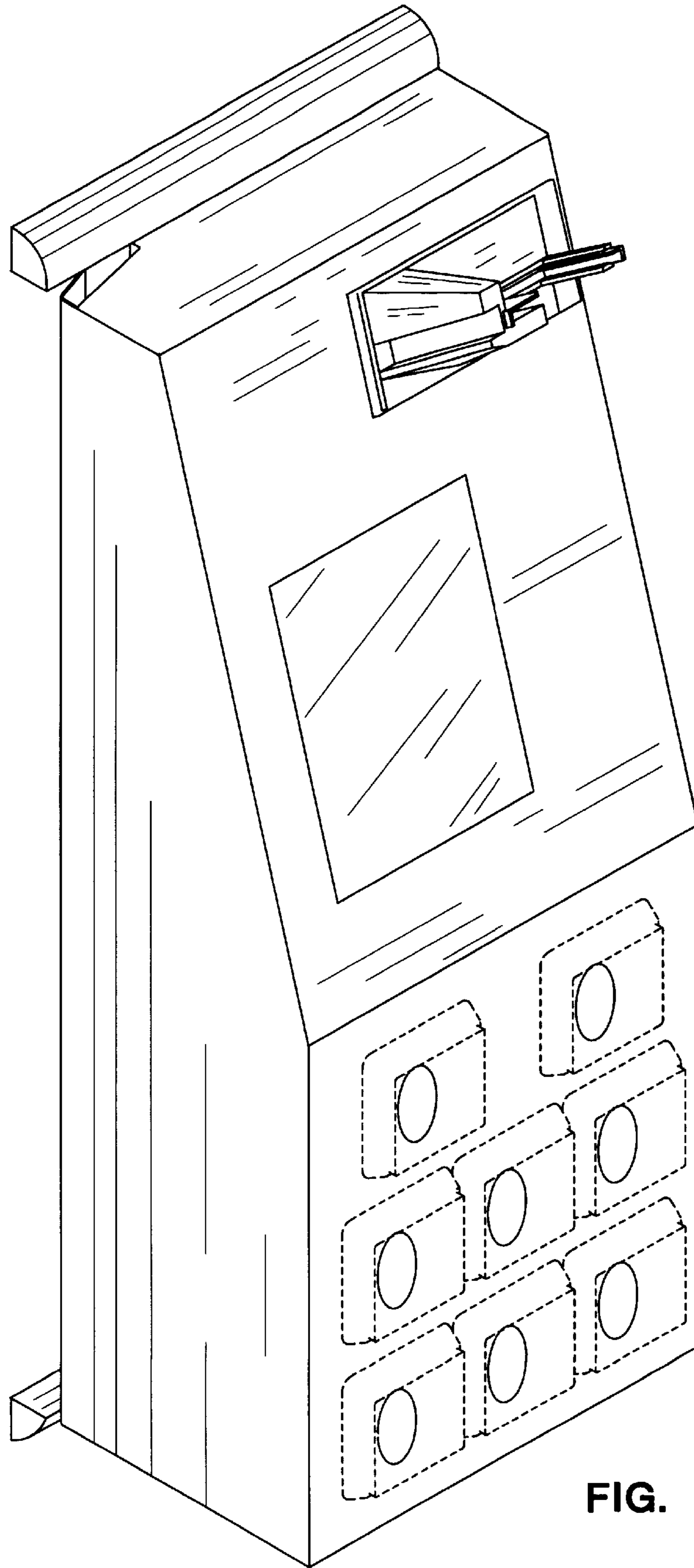

FIG. 2

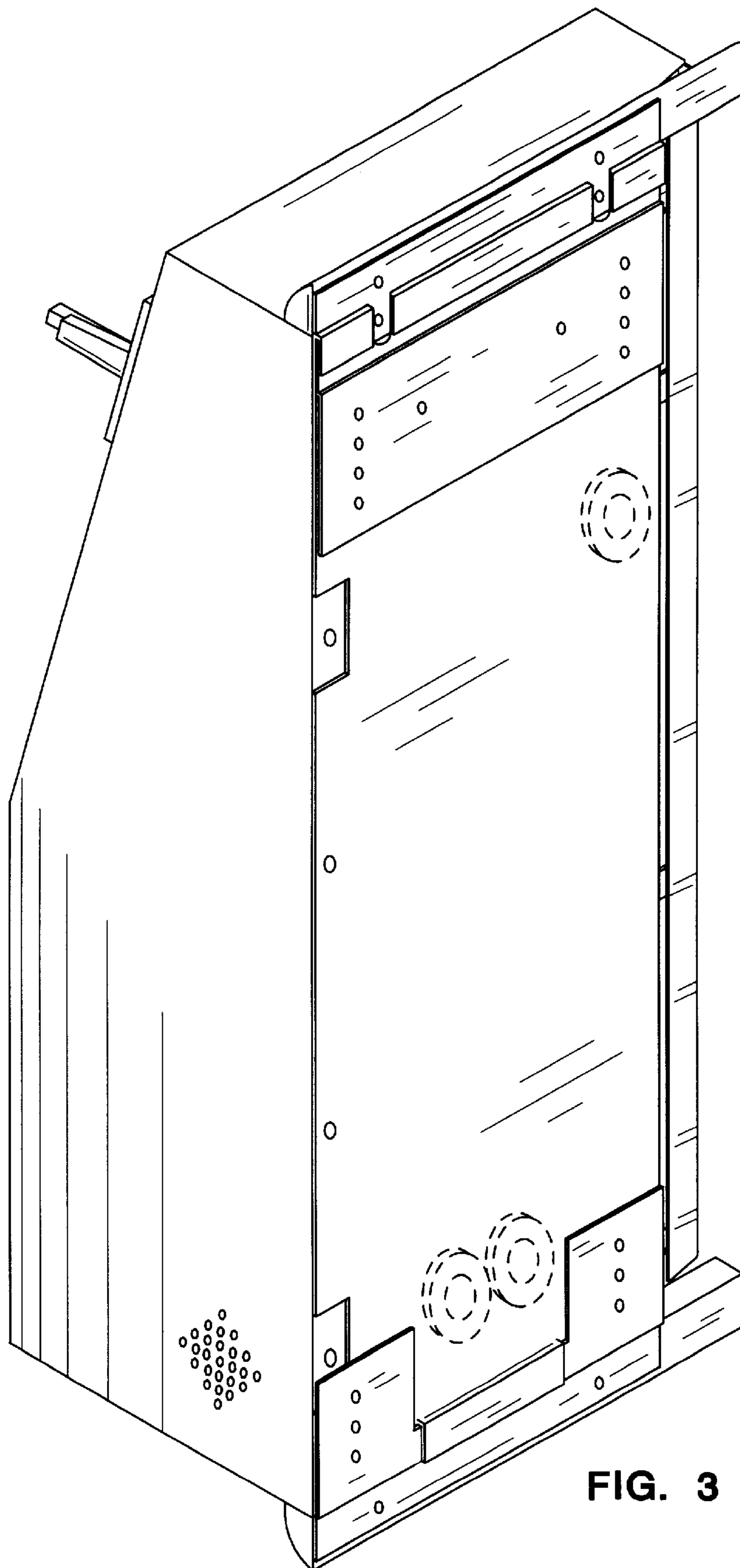

FIG. 3

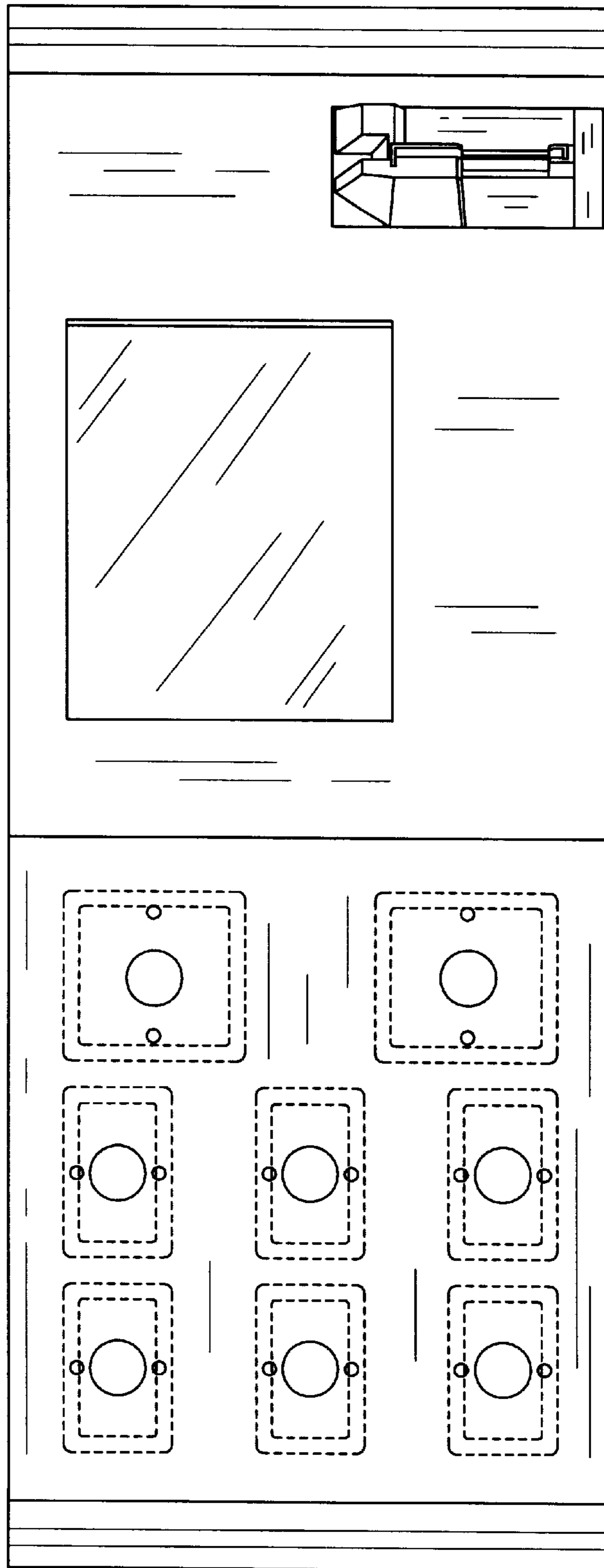

FIG. 4

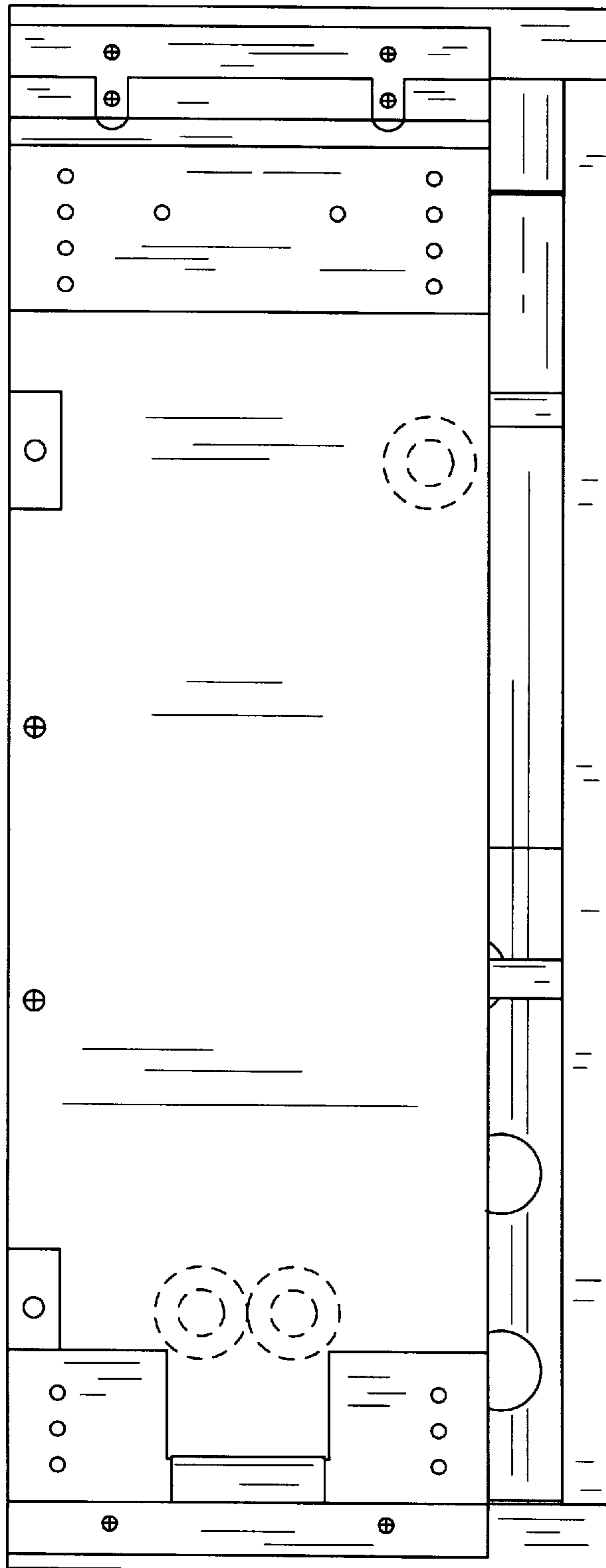

FIG. 5

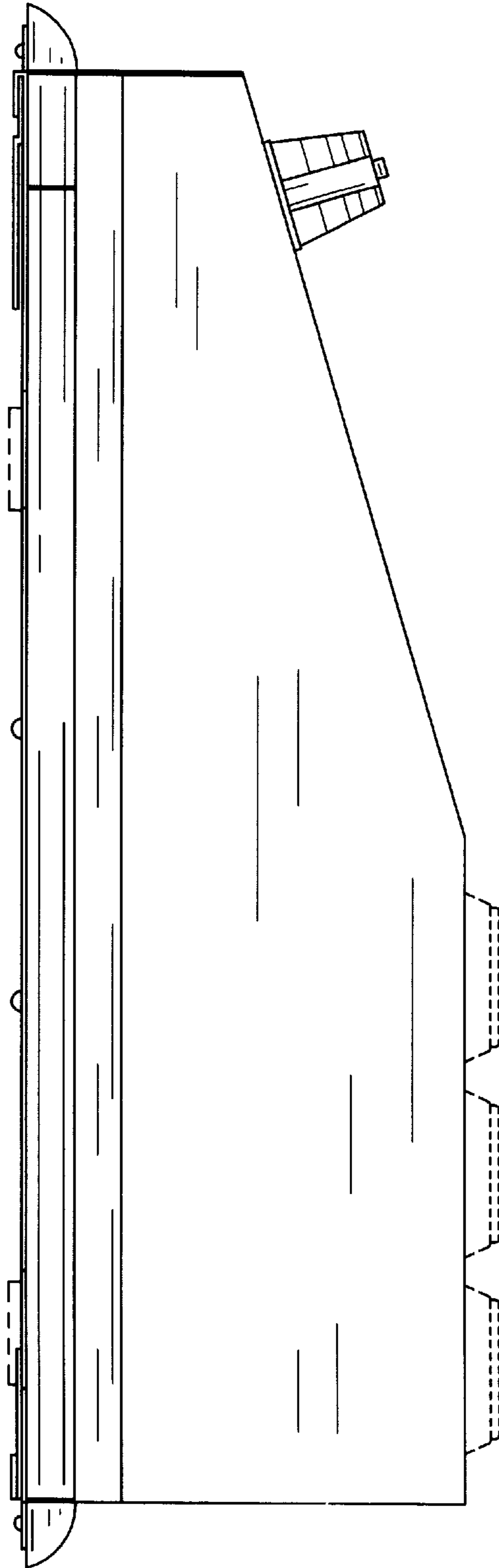

FIG. 6



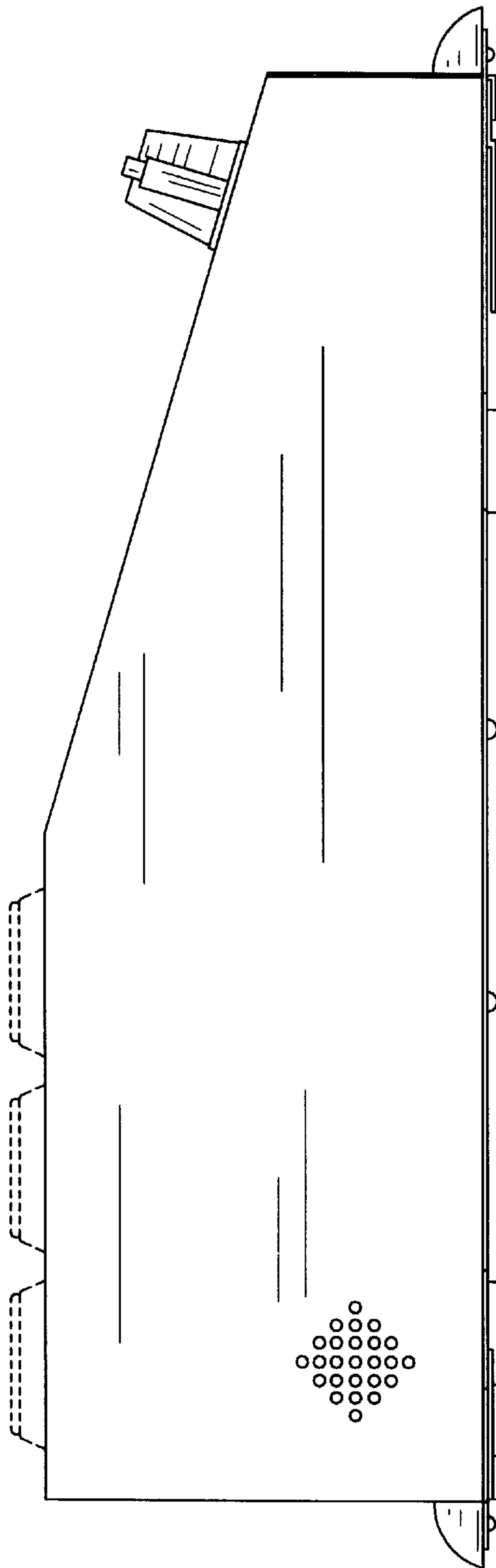

FIG. 7



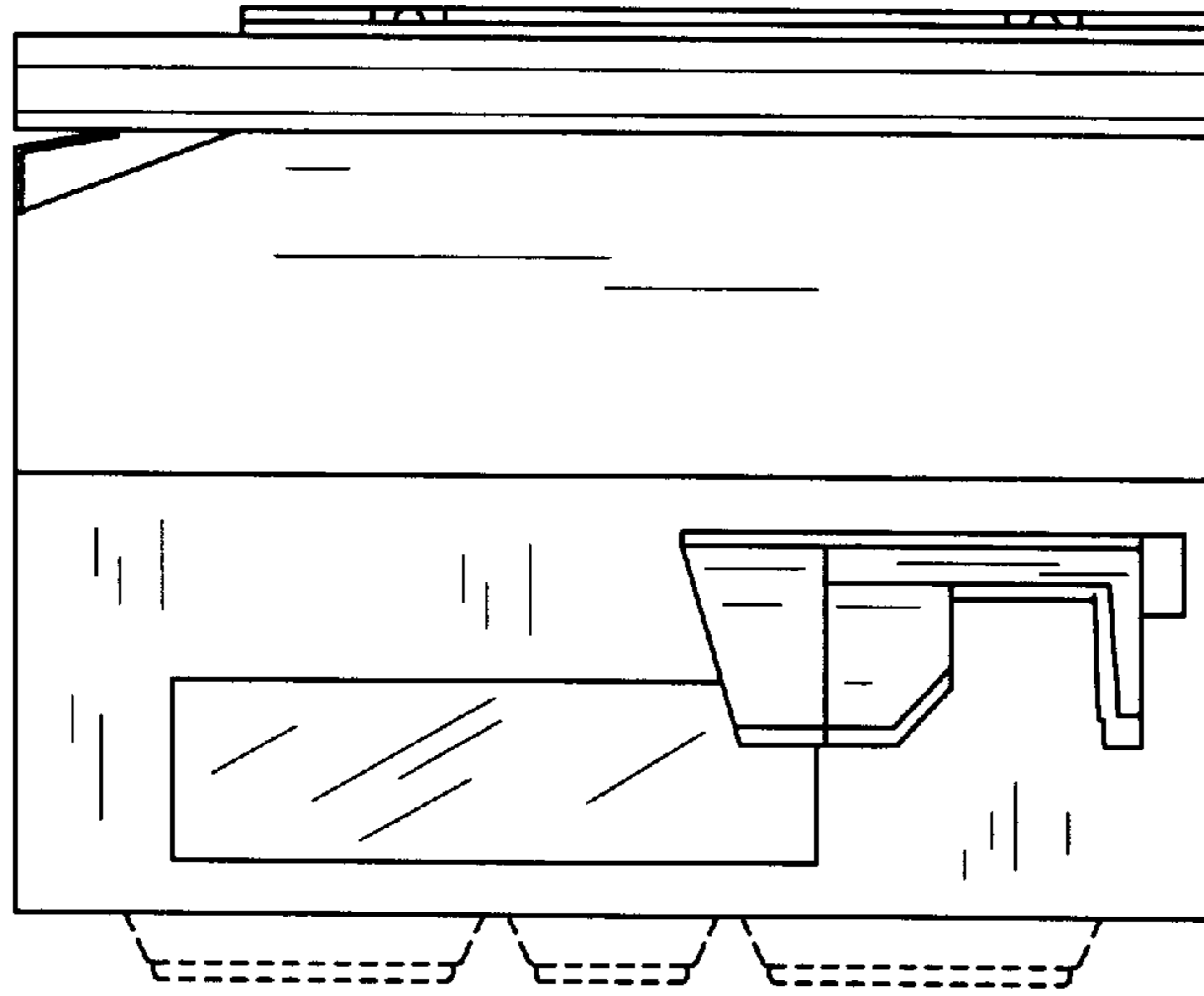

FIG. 8

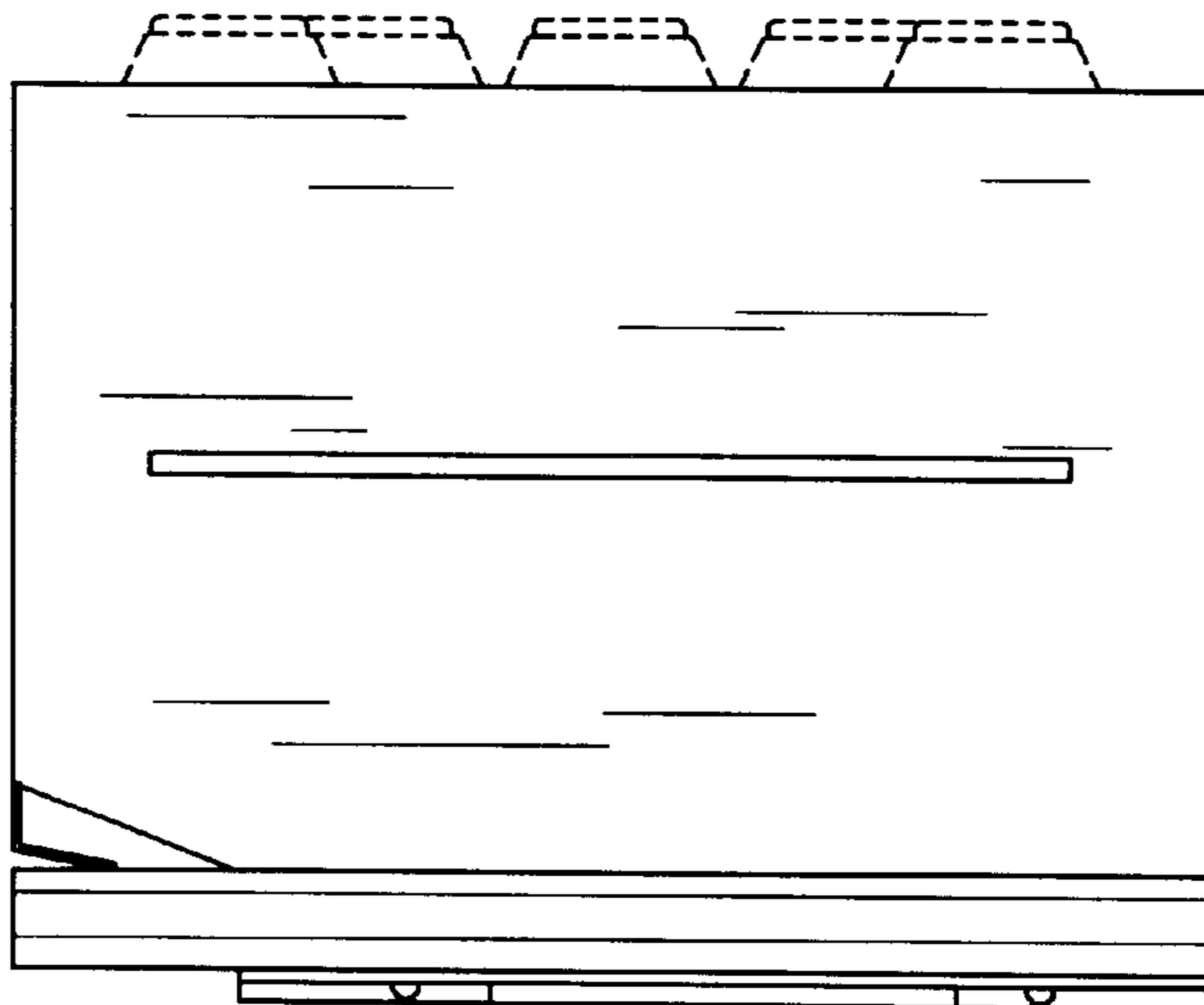

FIG. 9

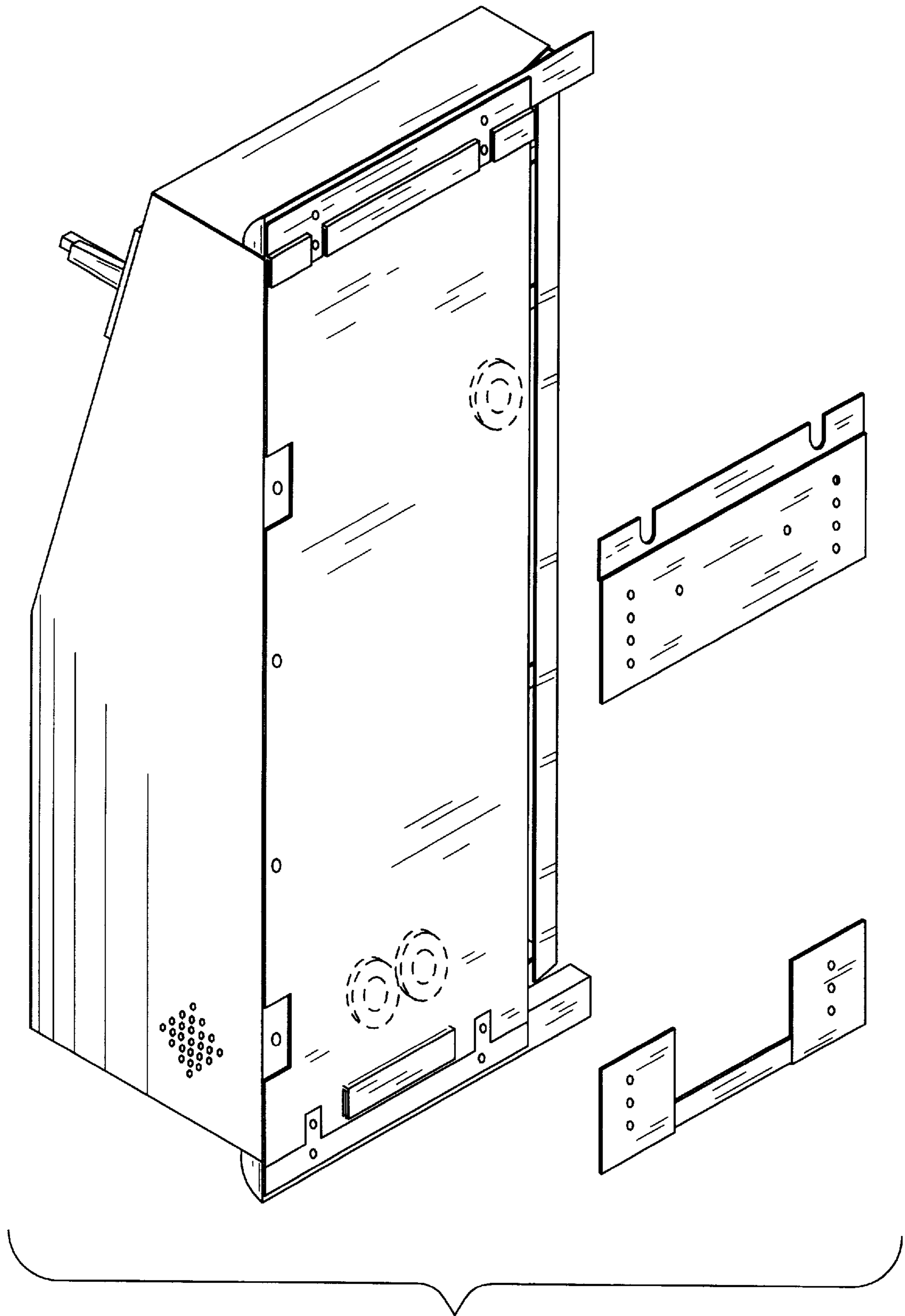

FIG. 10