



US00D441250S

(12) **United States Design Patent**
Choi

(10) **Patent No.:** **US D441,250 S**

(45) **Date of Patent:** **** May 1, 2001**

(54) **GRILL**

(75) Inventor: **Lung Wai Choi, Kowloon (HK)**

(73) Assignee: **Goodway Electrical Co. Ltd.,
Kowloon (HK)**

(**) Term: **14 Years**

(21) Appl. No.: **29/118,014**

(22) Filed: **Feb. 2, 2000**

(30) **Foreign Application Priority Data**

Aug. 9, 1999 (GB) 2085643

(51) **LOC (7) Cl.** **07-02**

(52) **U.S. Cl.** **D7/362**

(58) **Field of Search** D7/332, 337, 362-367,
D7/402, 407, 352; 99/392, 399, 401, 422-423,
443 R, 427, 338, 331, 445-446, 450, 341;
219/450.1, 532-533, 429, 432, 443.1

(56) **References Cited**

U.S. PATENT DOCUMENTS

- D. 377,134 * 1/1997 Touche D7/362
- D. 380,342 * 7/1997 Edmonds D7/363

- D. 424,367 * 5/2000 Choi D7/363
- D. 429,946 * 8/2000 Lee D7/362
- D. 431,152 * 9/2000 Lee D7/362
- 5,884,555 * 3/1999 Chang 99/425
- 6,024,014 * 2/2000 Kasai 99/425
- 6,064,042 * 5/2000 Glucksman et al. 219/452.13

* cited by examiner

Primary Examiner—Ruth McInroy

(74) *Attorney, Agent, or Firm*—Christensen O'Connor
Johnson Kindness PLLC

(57) **CLAIM**

I claim the ornamental design for a grill, as shown and described.

DESCRIPTION

FIG. 1 is a perspective view of a grill showing my new design;
 FIG. 2 is a top view thereof;
 FIG. 3 is a bottom view thereof;
 FIG. 4 is a front view thereof;
 FIG. 5 is a rear view thereof;
 FIG. 6 is a right side view thereof; and,
 FIG. 7 is a left side view thereof.

1 Claim, 5 Drawing Sheets

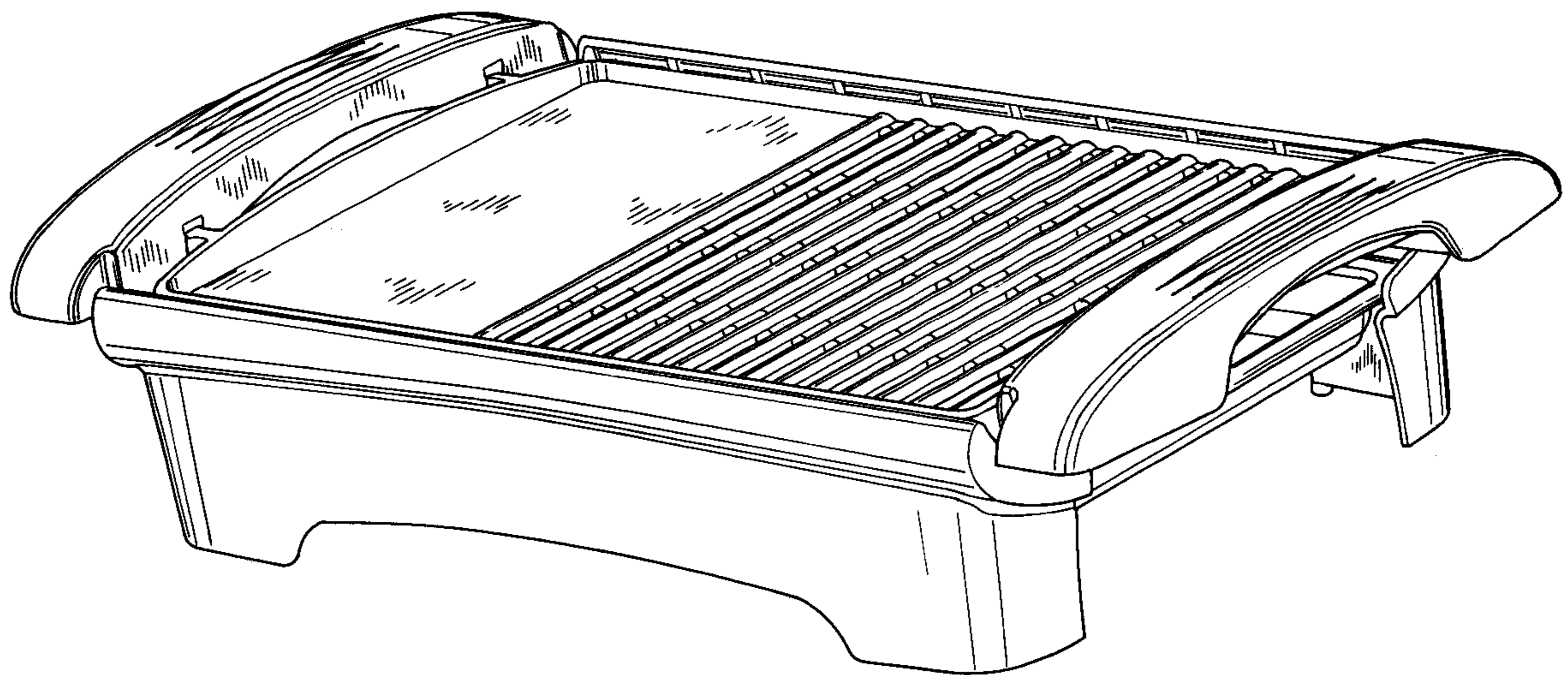

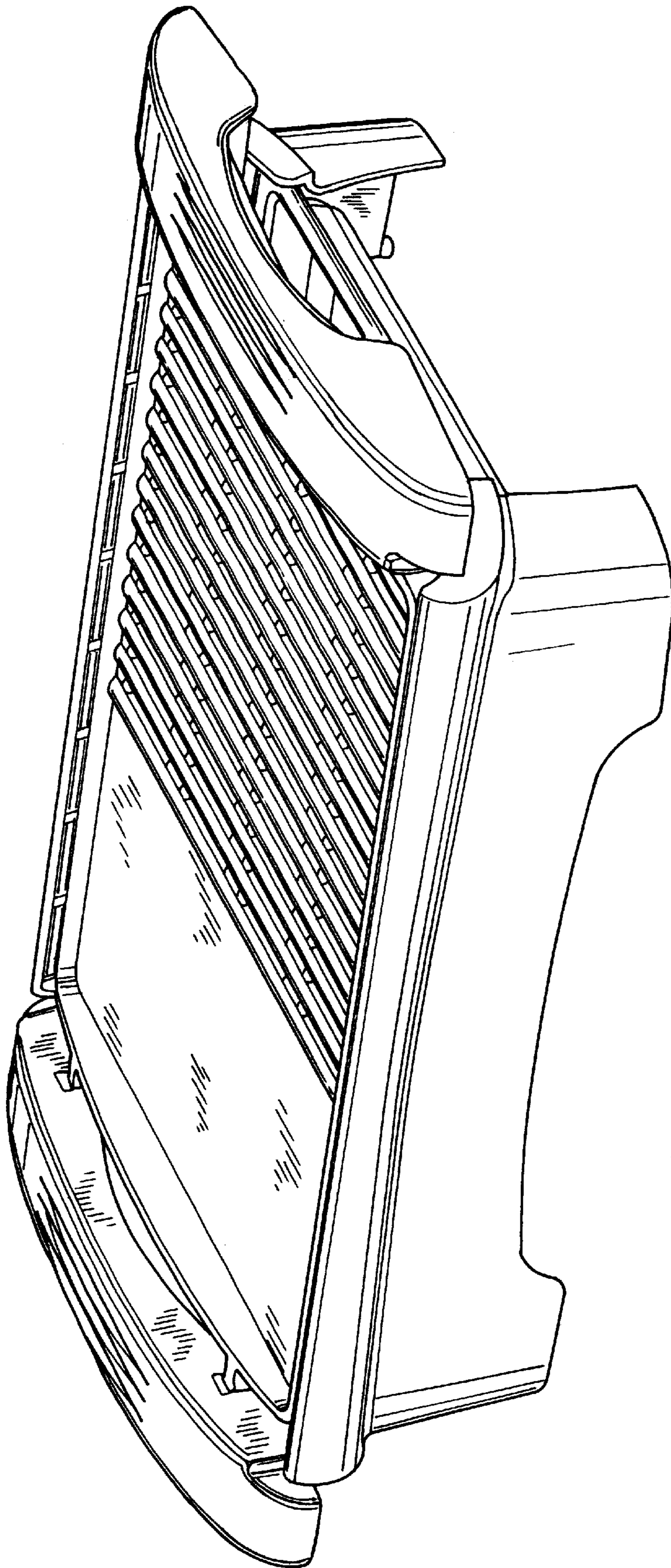

FIG 1

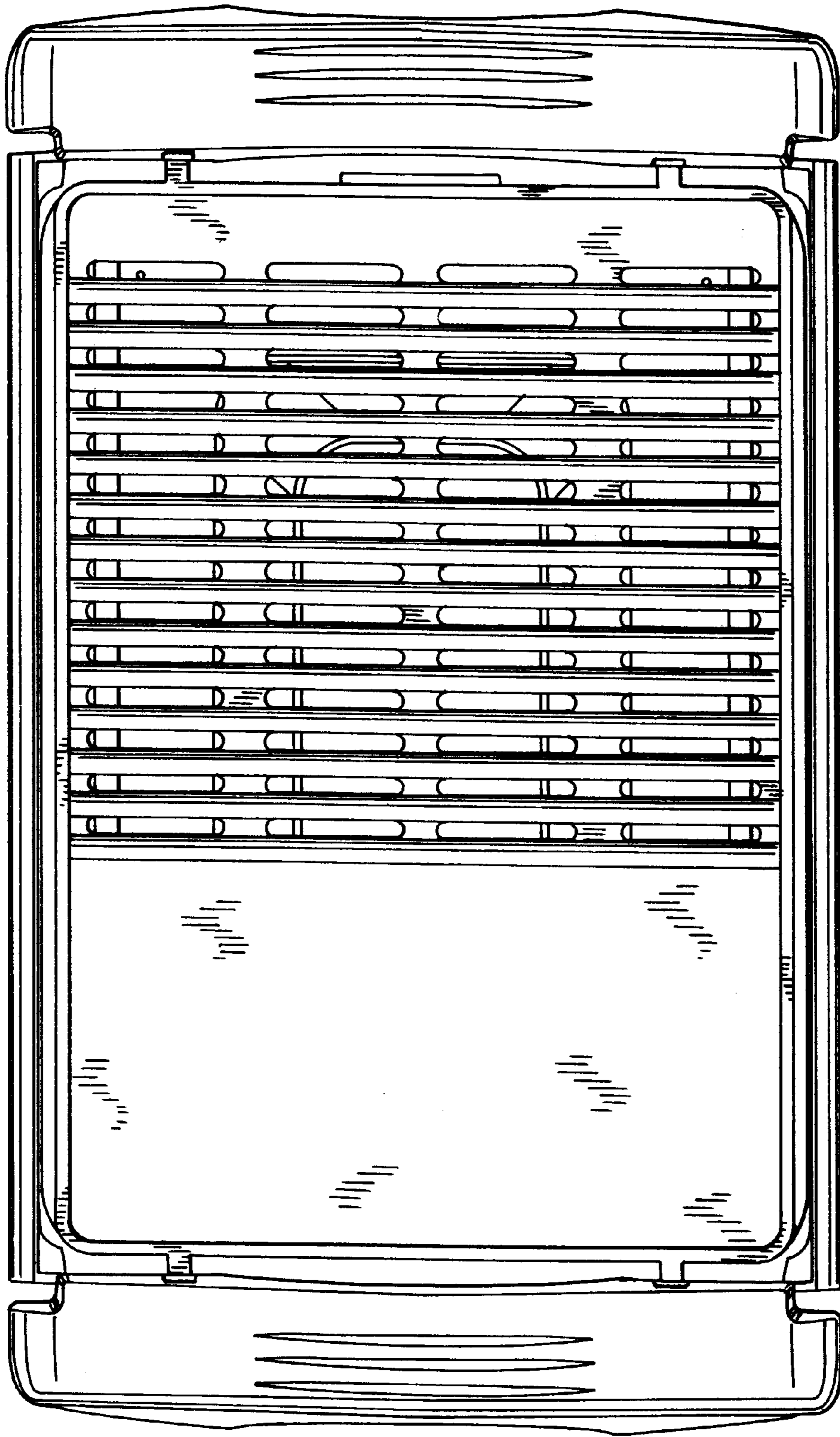

FIG 2

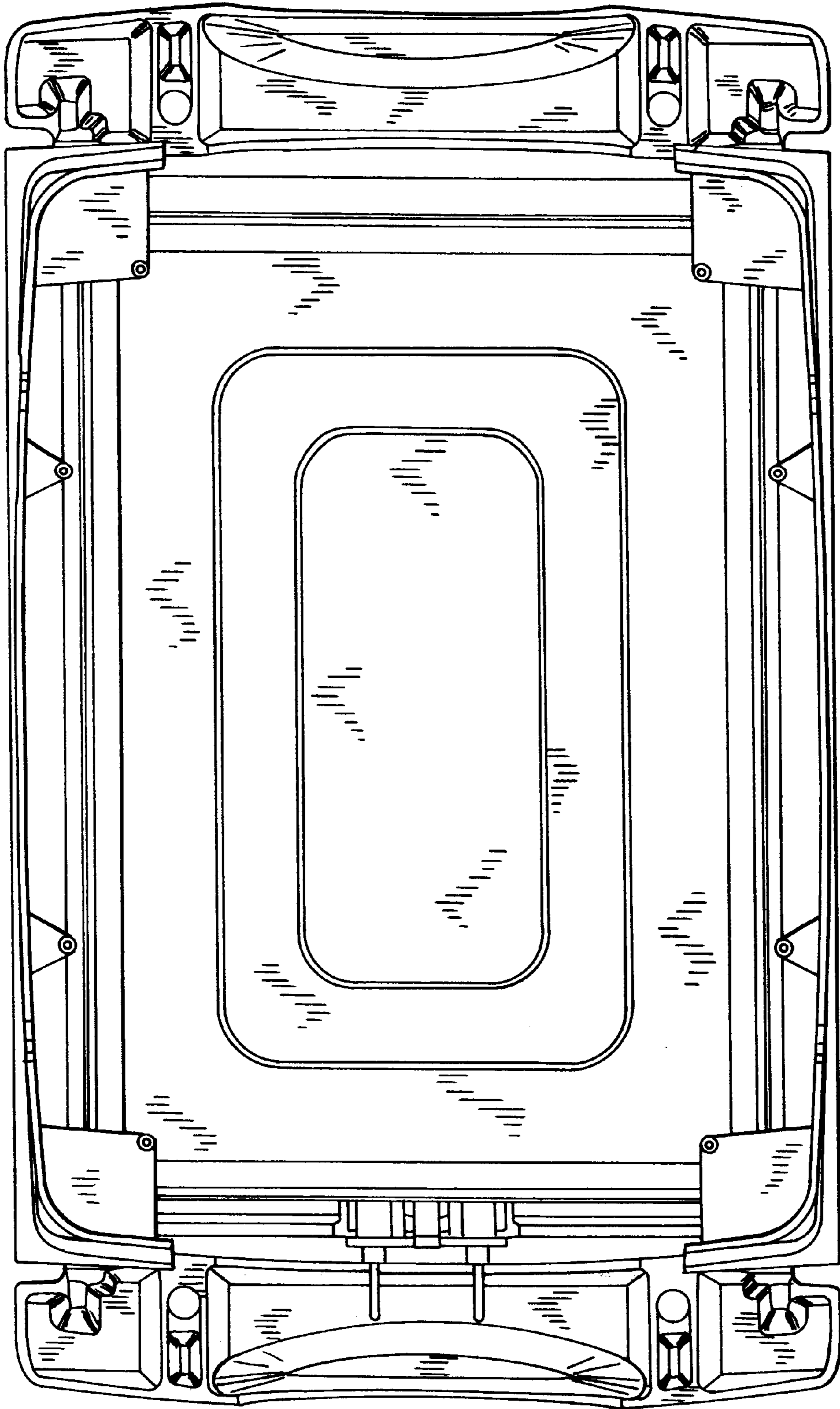

FIG 3

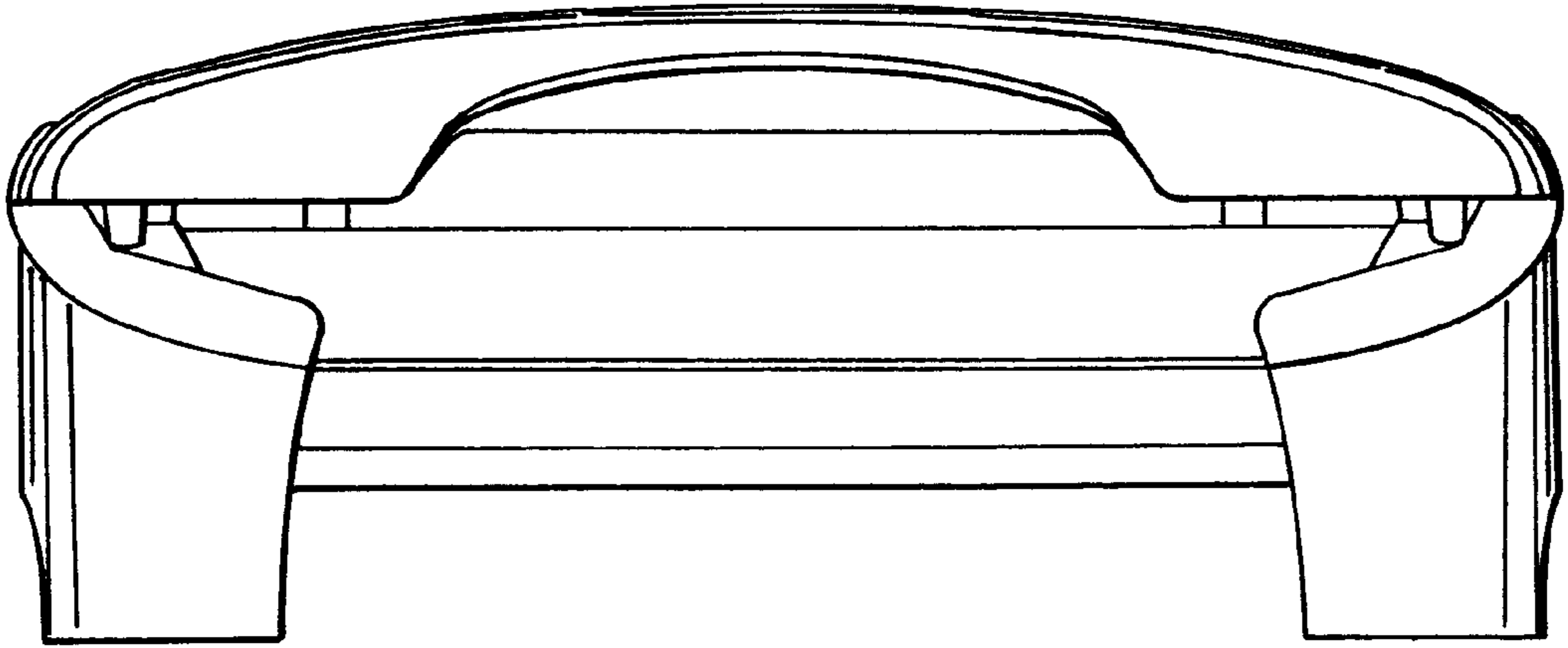

FIG 4

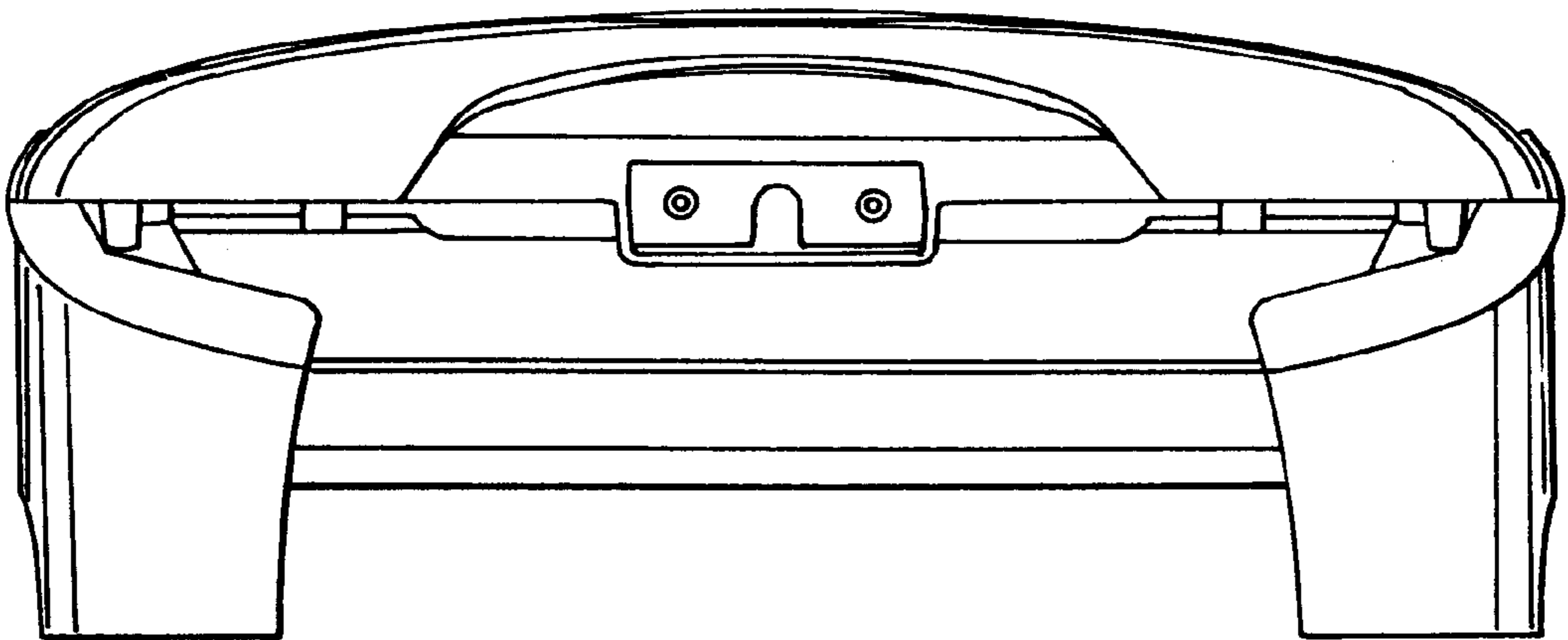

FIG 5

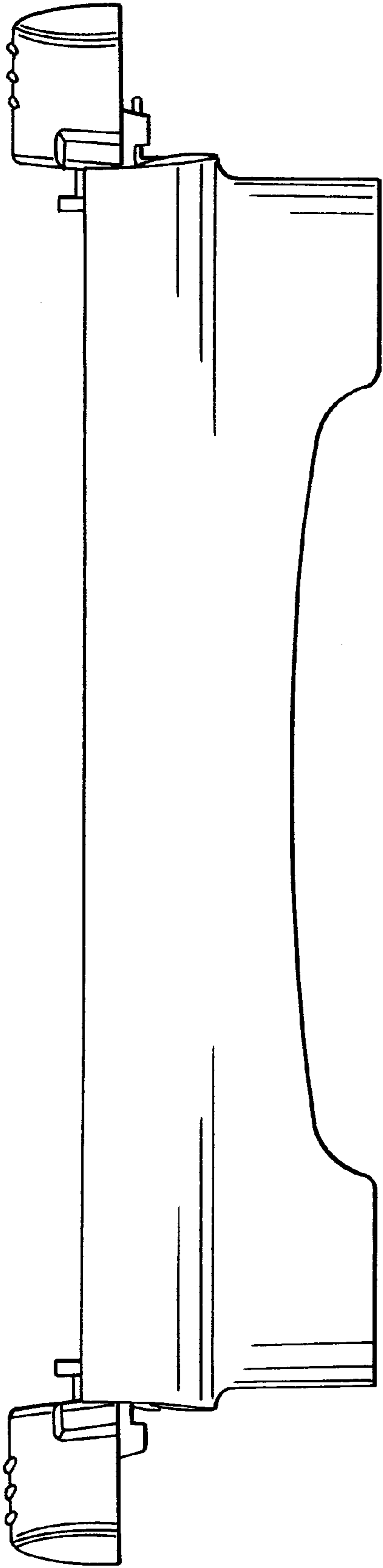

FIG 6

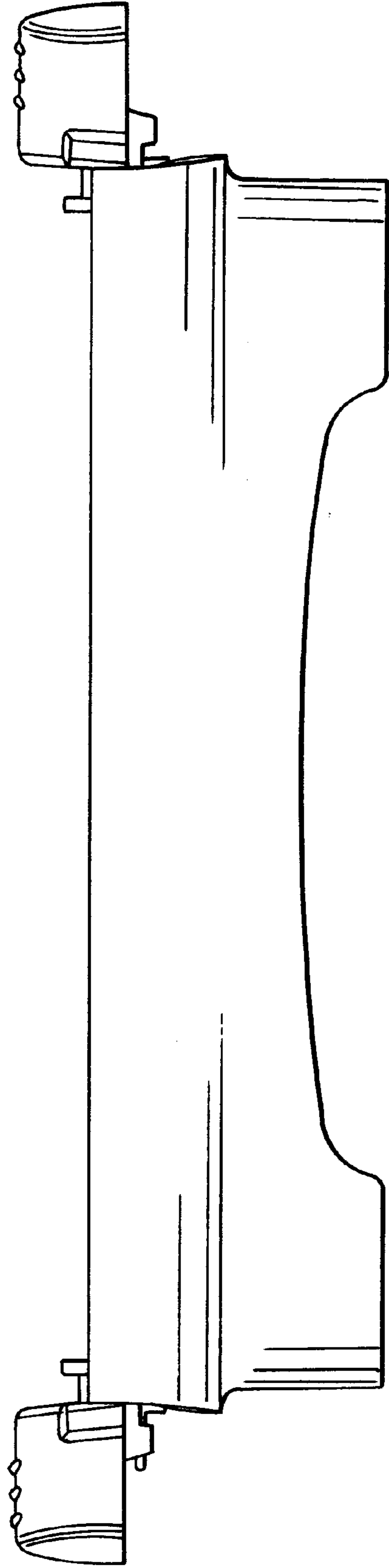

FIG 7