



US00D441228S

(12) **United States Design Patent** (10) **Patent No.:** **US D441,228 S**  
**Andersson** (45) **Date of Patent:** **\*\* May 1, 2001**

(54) **PAPER DISPENSER**

(75) Inventor: **Jerker Andersson**, Göteborg (SE)

(73) Assignee: **SCA Hygiene Products AB**,  
Gothenburg (SE)

(\*\*) Term: **14 Years**

(21) Appl. No.: **29/130,026**

(22) Filed: **Sep. 27, 2000**

**Related U.S. Application Data**

(62) Division of application No. 29/114,421, filed on Nov. 24, 1999.

(30) **Foreign Application Priority Data**

May 26, 1999	(SE)	.....	99-0942
May 26, 1999	(SE)	.....	99-0944
May 26, 1999	(SE)	.....	99-0947

(51) **LOC (7) Cl.** ..... **20-02**

(52) **U.S. Cl.** ..... **D6/518**

(58) **Field of Search** ..... D6/518, 521, 522,  
D6/523; 206/389, 824; 221/26, 33, 282,  
283; 242/570; 312/34.1, 34.4, 34.8

(56) **References Cited**

**U.S. PATENT DOCUMENTS**

D. 326,973	6/1992	Froidevaux .
D. 336,581	6/1993	Parker .
D. 337,680	7/1993	Guigliaro .
D. 351,520	10/1994	Frazier et al. .
D. 358,516	5/1995	Chen .

**OTHER PUBLICATIONS**

Svensk Byggkatalog, p. 40, Jun. 1998 (Svenskbyggjtjanst).

*Primary Examiner*—Brian N. Vinson

(74) *Attorney, Agent, or Firm*—Burns, Doane, Swecker & Mathis, L.L.P.

(57) **CLAIM**

The ornamental design for a paper dispenser, as shown and described.

**DESCRIPTION**

FIG. 1 is a front, side perspective view of a paper dispenser showing my new design;

FIG. 2 is a side perspective view thereof, with the casing portion being shown in an open position;

FIG. 3 is a rear perspective view of the casing portion of the paper dispenser shown in FIG. 1, with the wall mounting portion being removed for clarity;

FIG. 4 is a front, side perspective view of the wall mounting portion of the paper dispenser shown in FIG. 1, with the casing portion being removed for clarity;

FIG. 5 is a bottom perspective view thereof;

FIG. 6 is a top perspective view thereof;

FIG. 7 is a rear perspective view thereof;

FIG. 8 is a front perspective view of the rear base platform of the wall mounting portion shown in FIGS. 4-7;

FIG. 9 is a front perspective view thereof, including the position plate in a first position;

FIG. 10 is a front perspective view thereof, including the position plate in a second position;

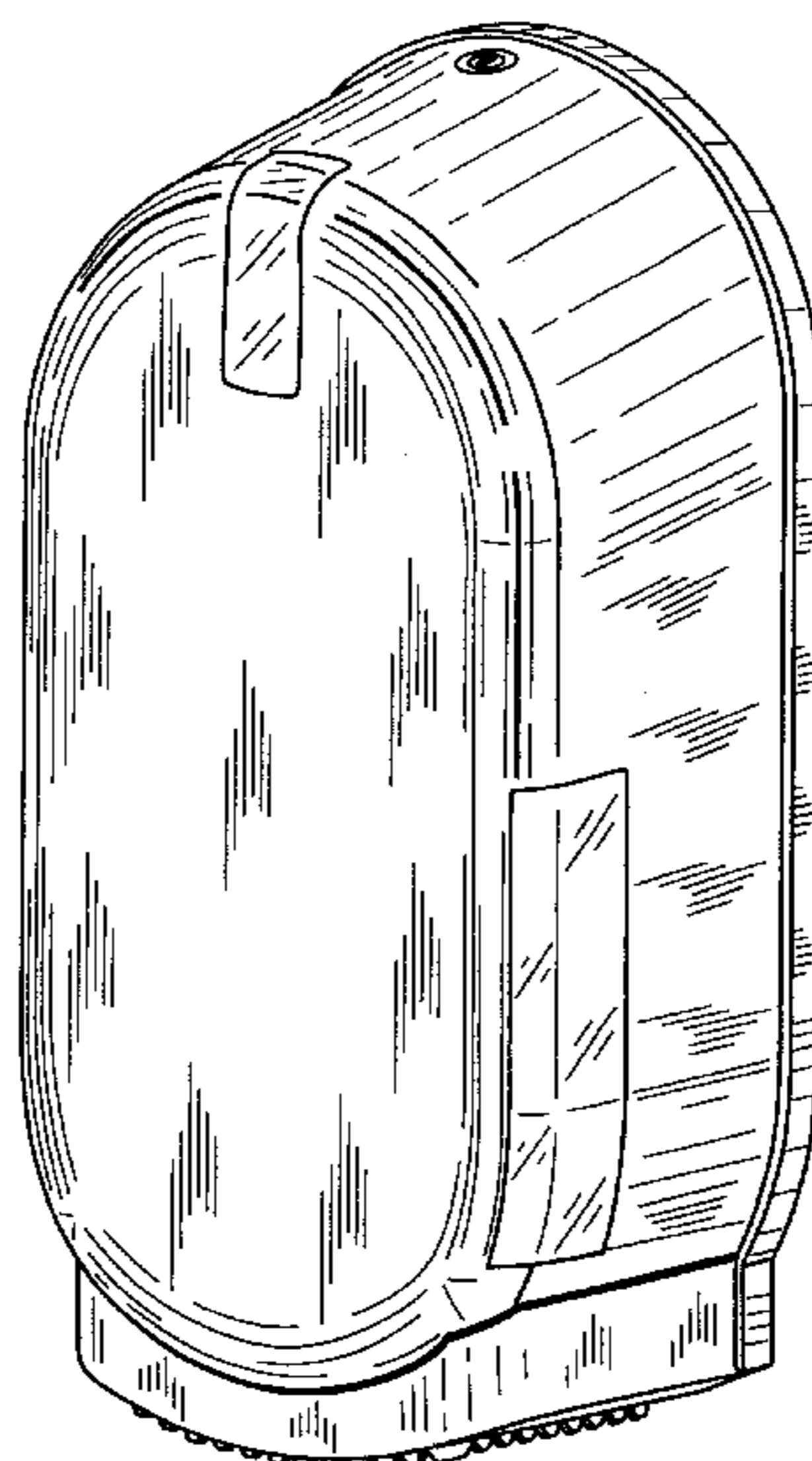
FIG. 11 is a side perspective view of the paper holder of the wall mounting portion shown in FIGS. 4-7;

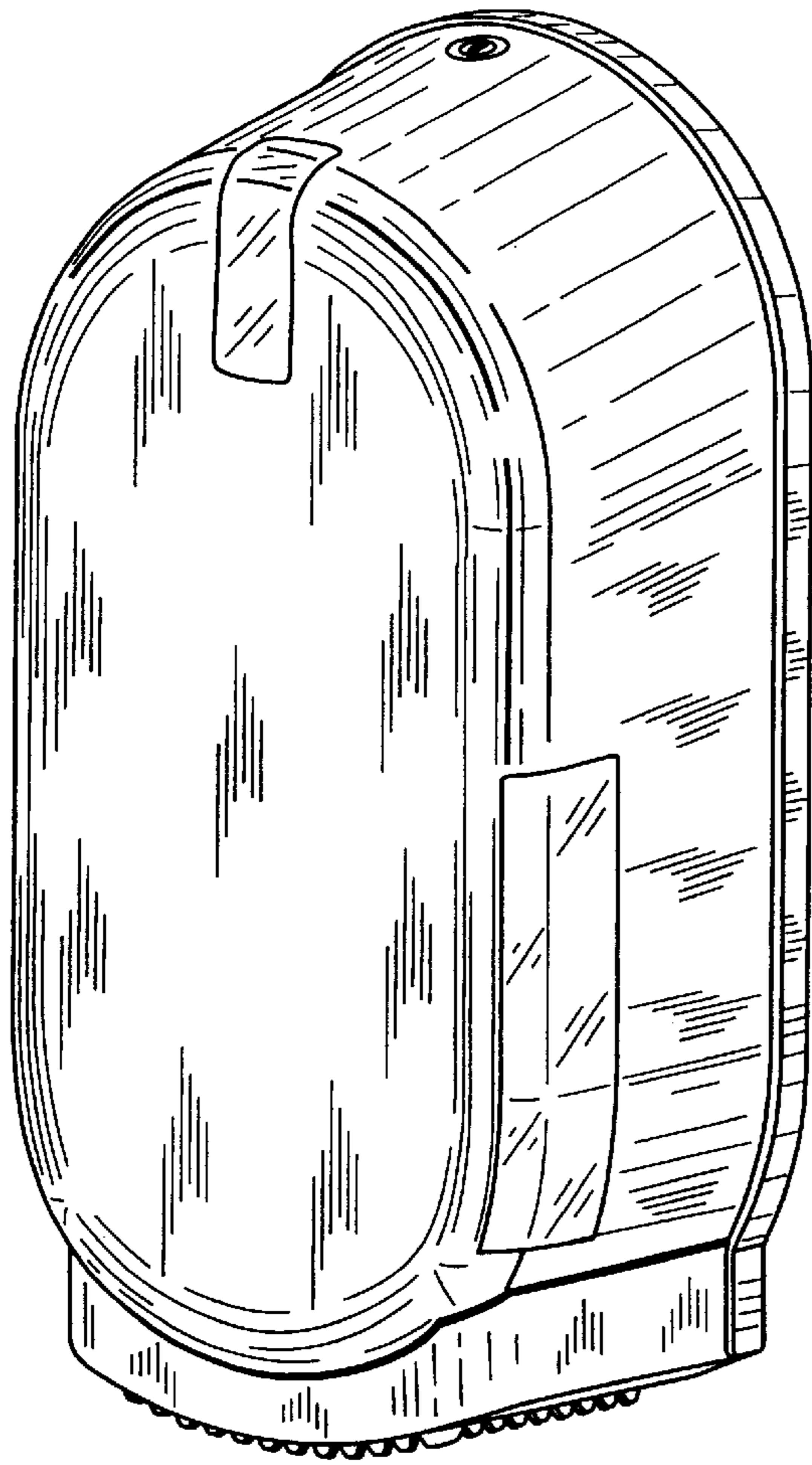
FIG. 12 is a bottom perspective view thereof;

FIG. 13 is a front perspective view of the position plate of the wall mounting portion shown in FIGS. 4-7; and,

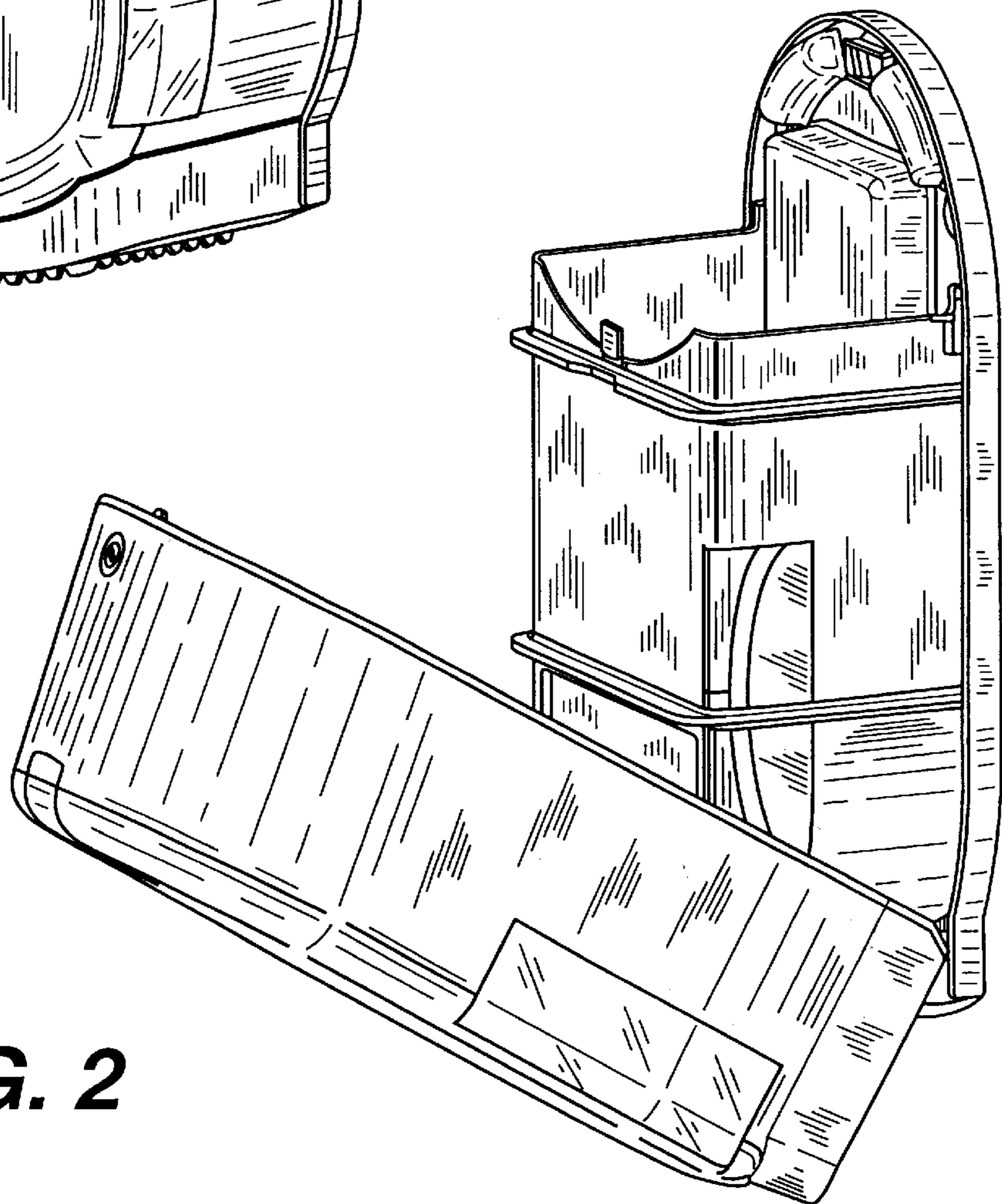
FIG. 14 is a rear perspective view thereof.

**1 Claim, 6 Drawing Sheets**

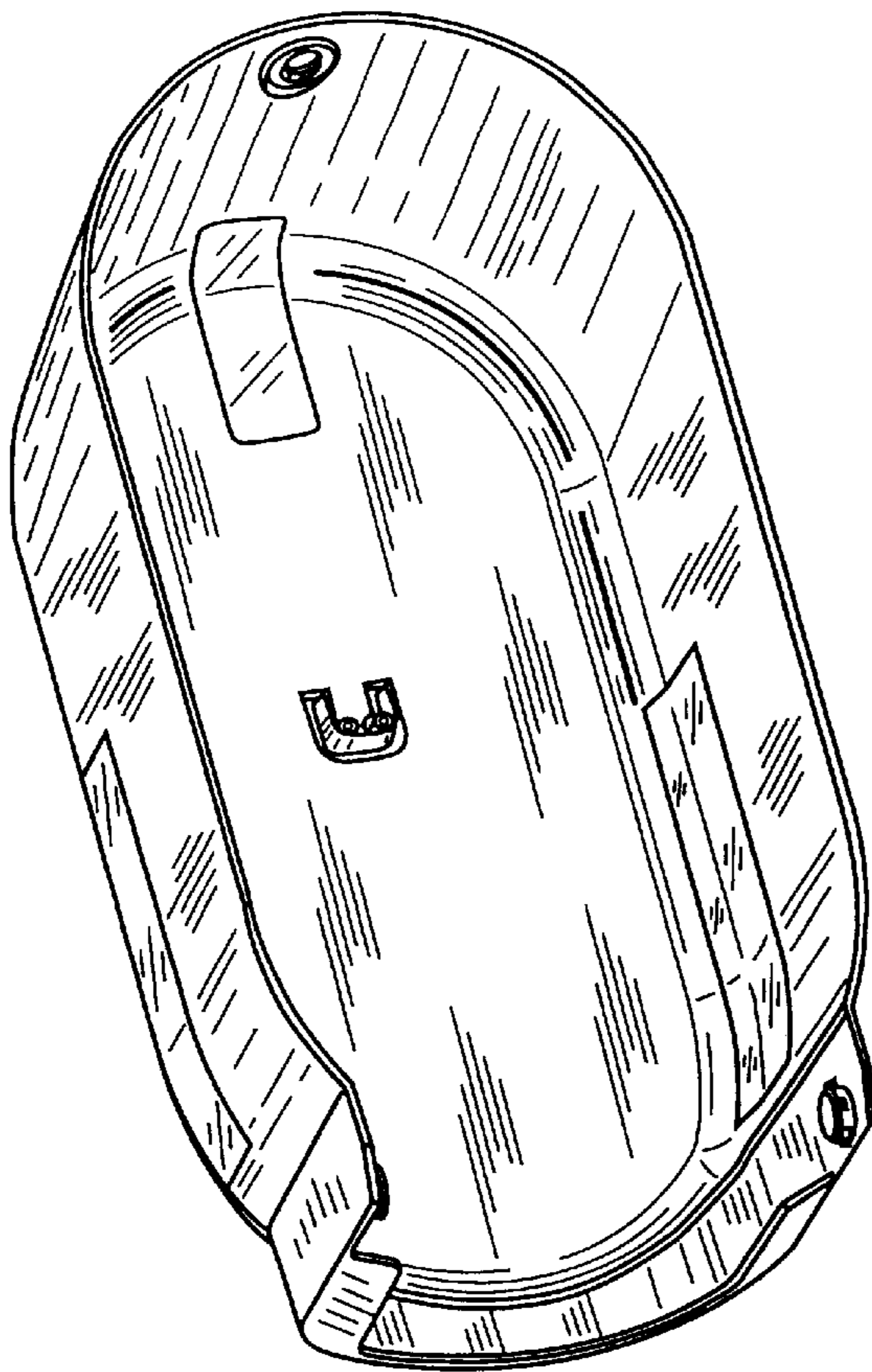




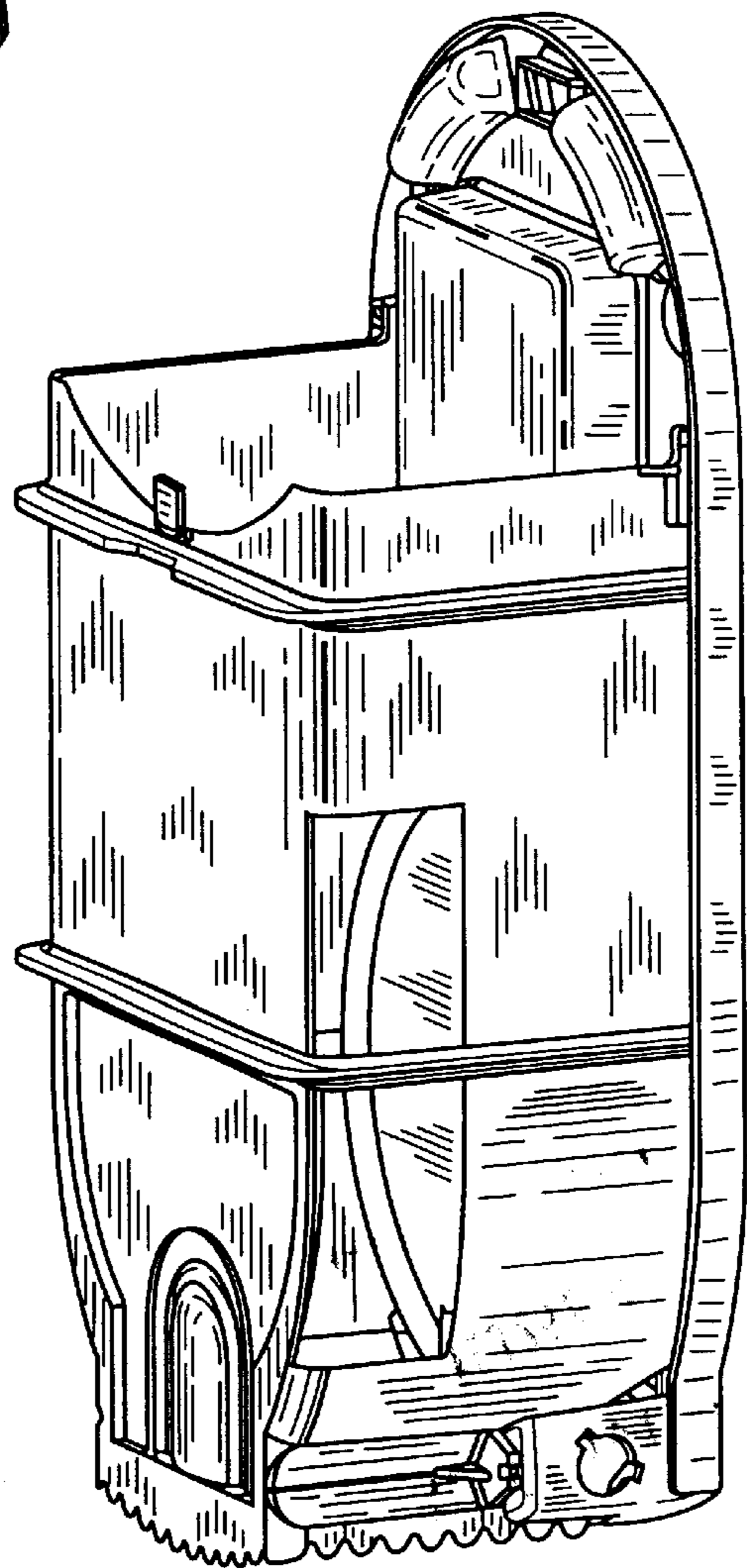
**FIG. 1**



**FIG. 2**

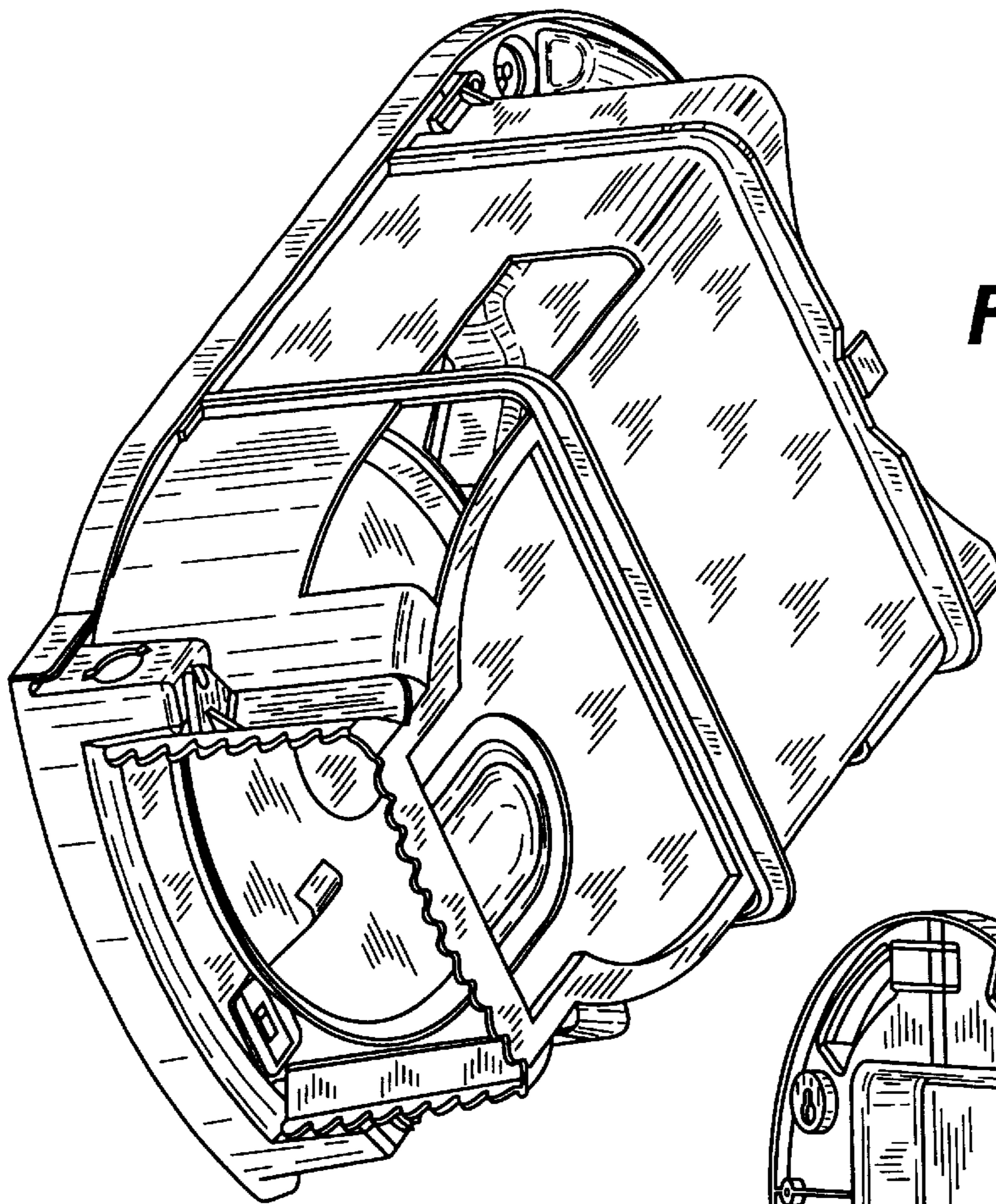


**FIG. 3**

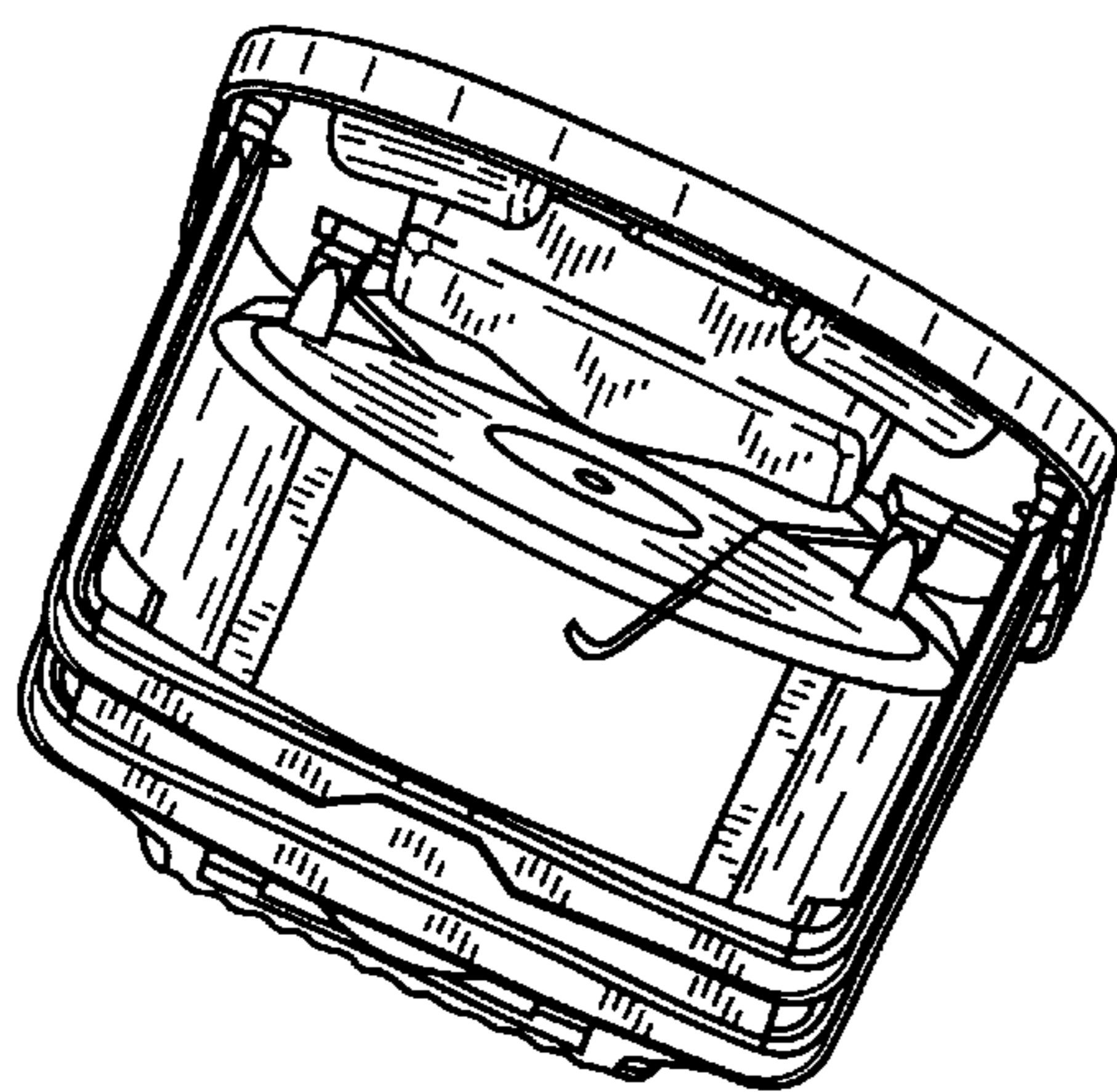


**FIG. 4**

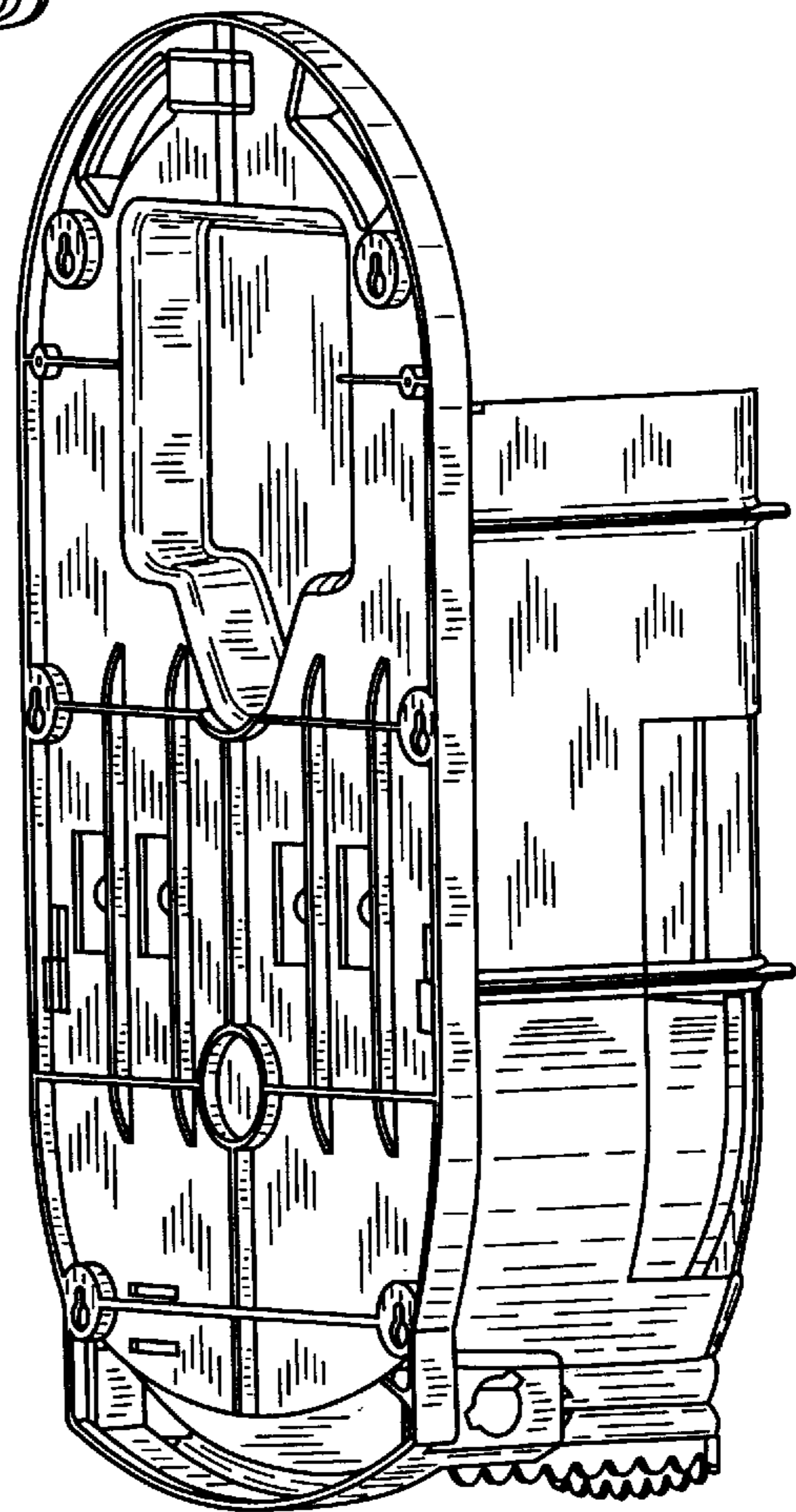




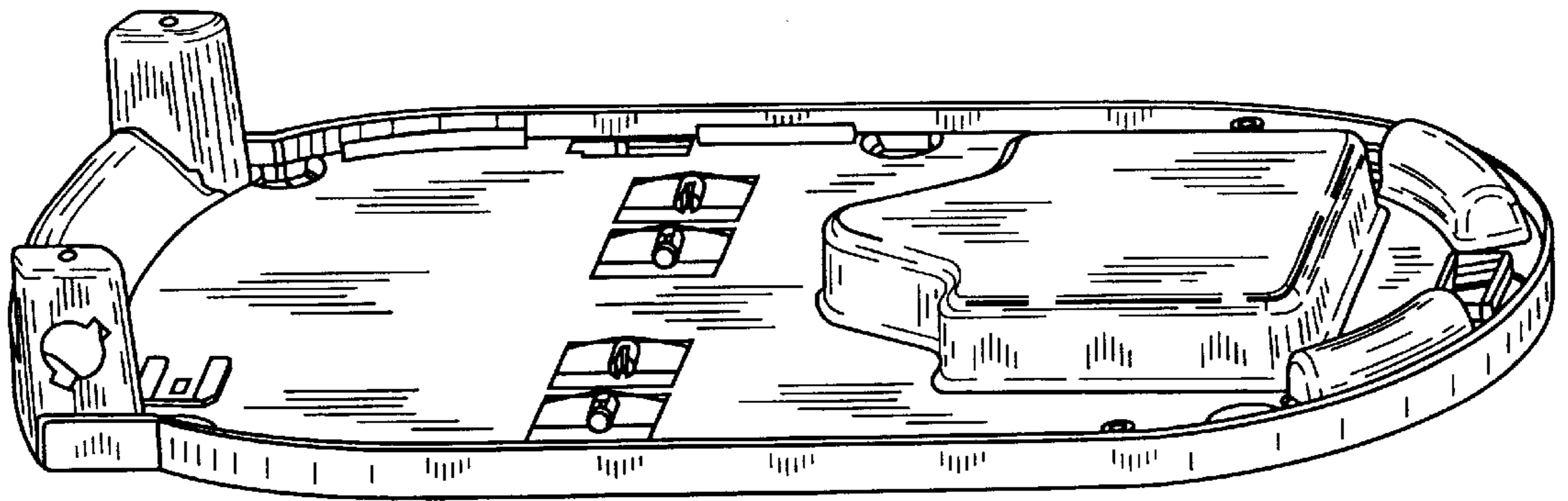
**FIG. 5**



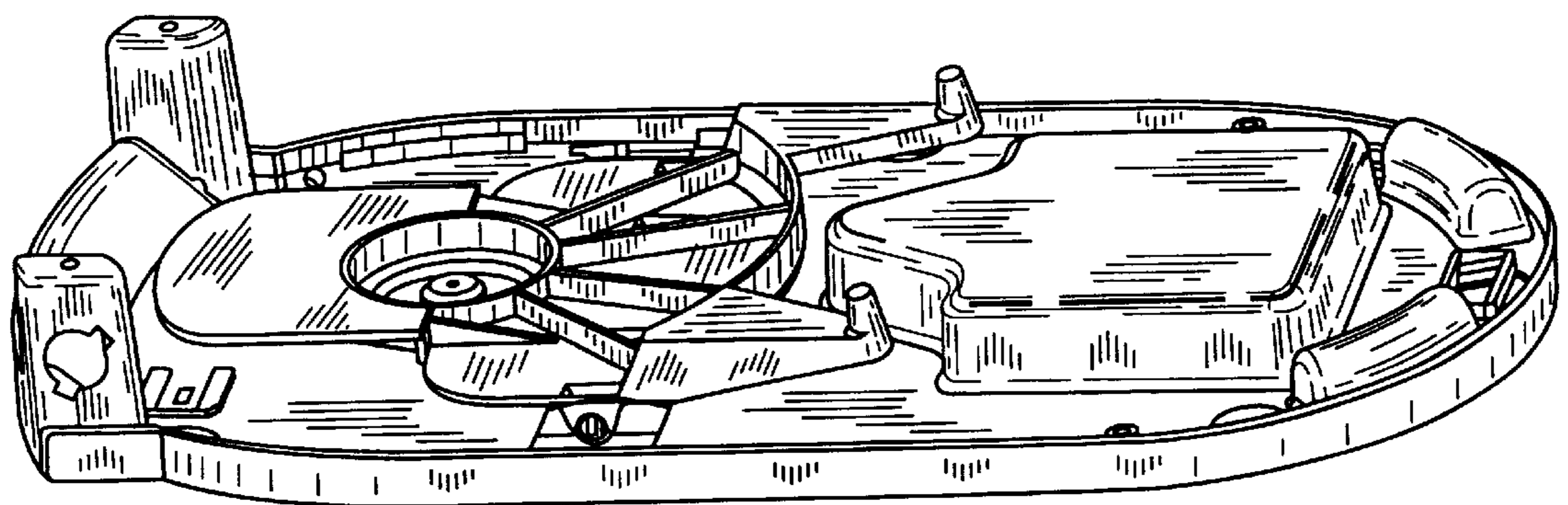
**FIG. 6**



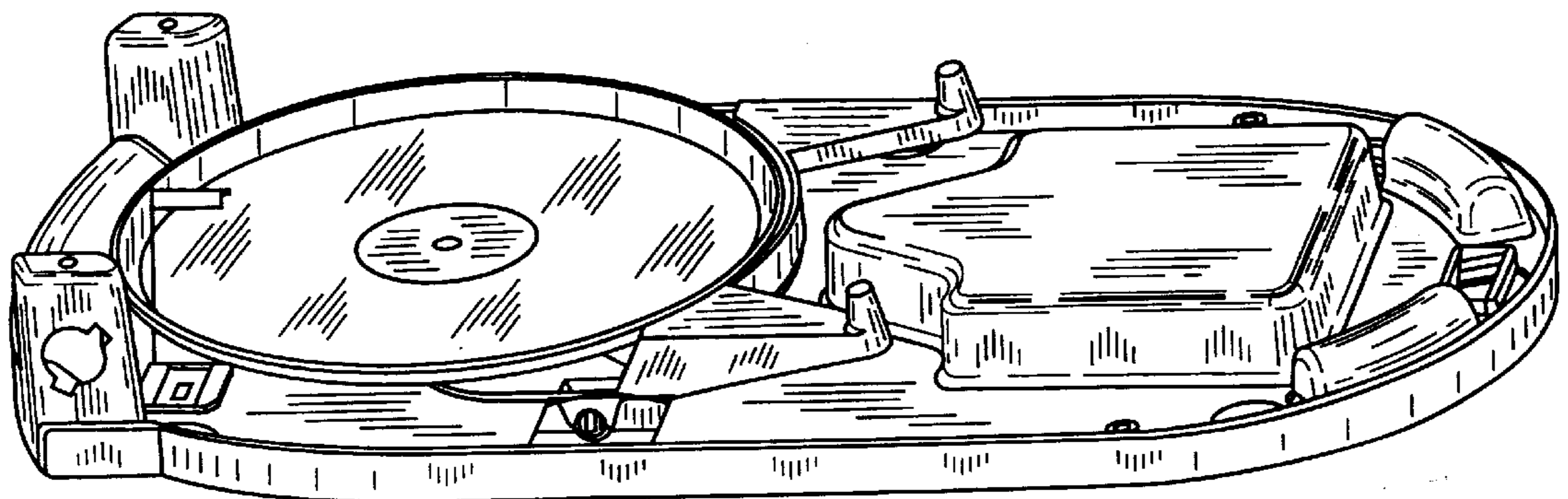
**FIG. 7**



**FIG. 8**

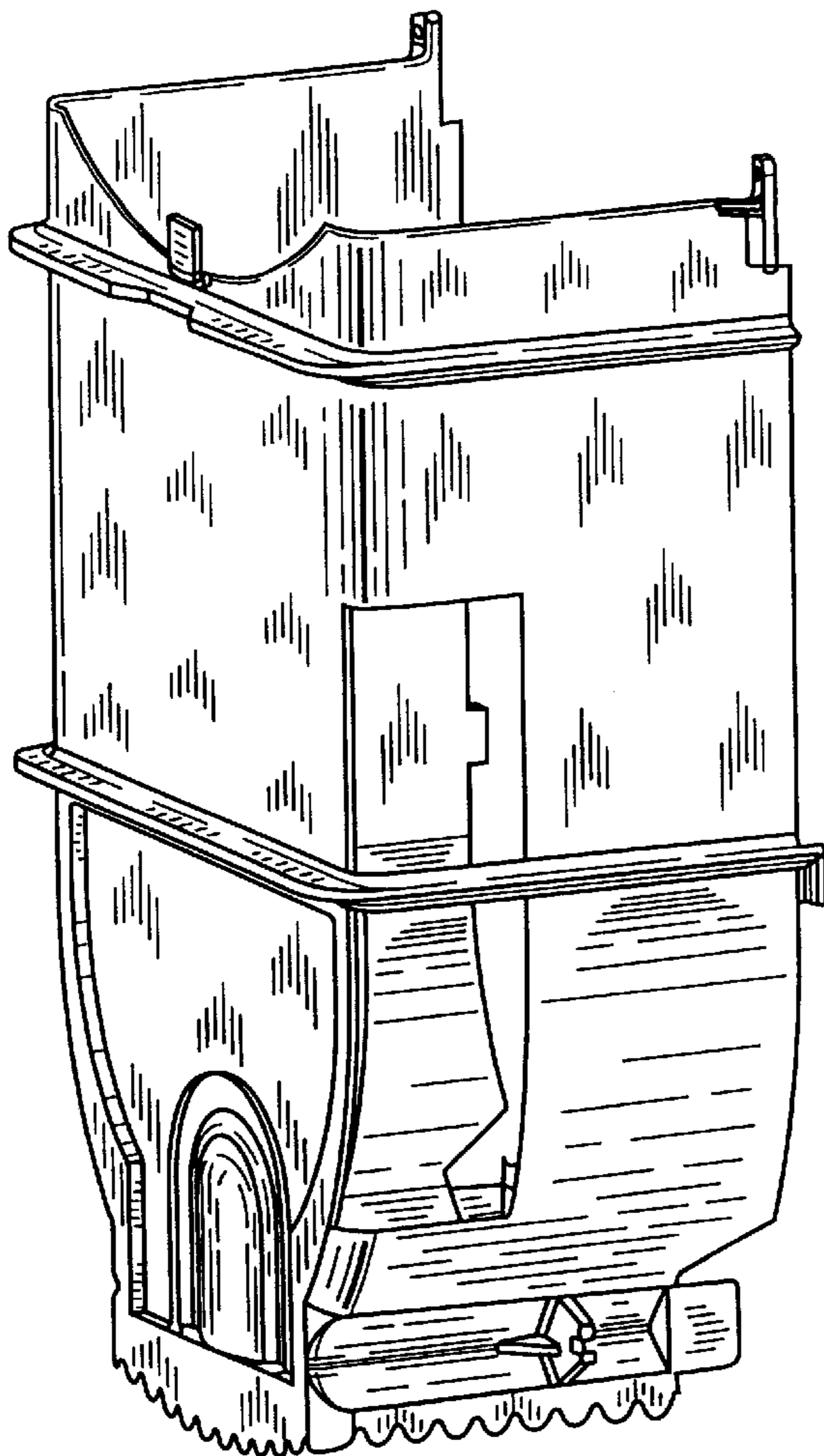


**FIG. 9**

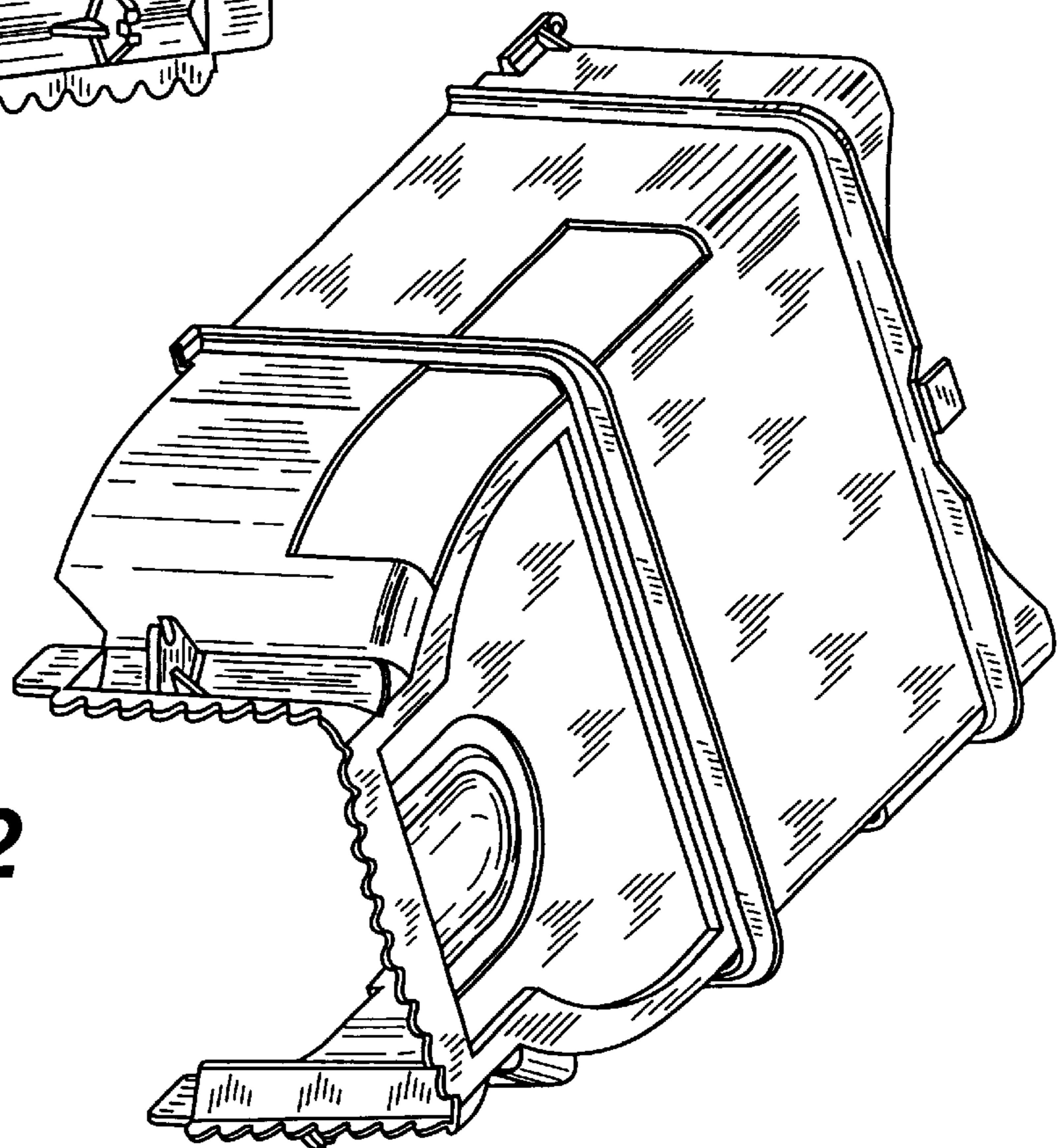


**FIG. 10**

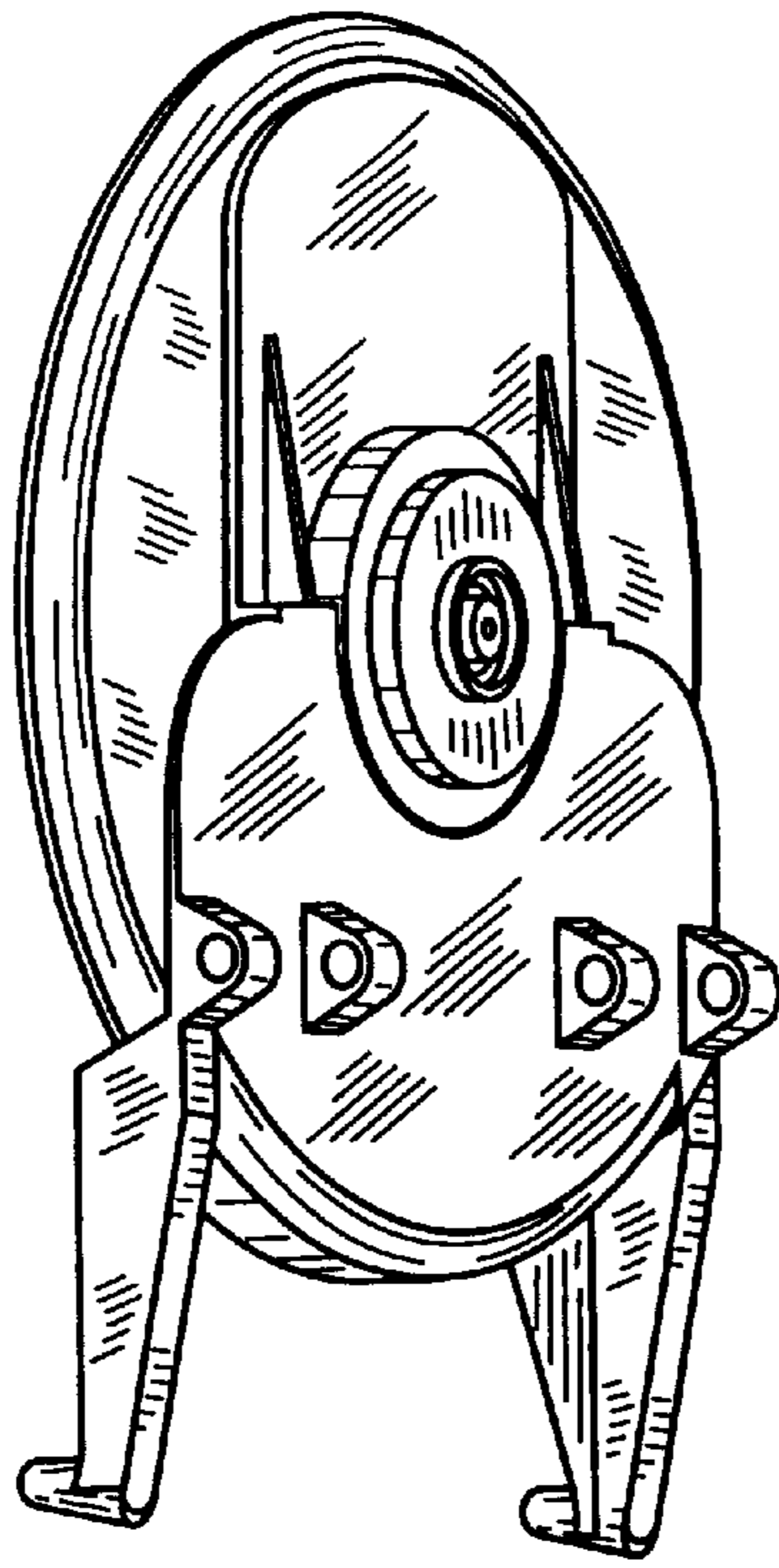




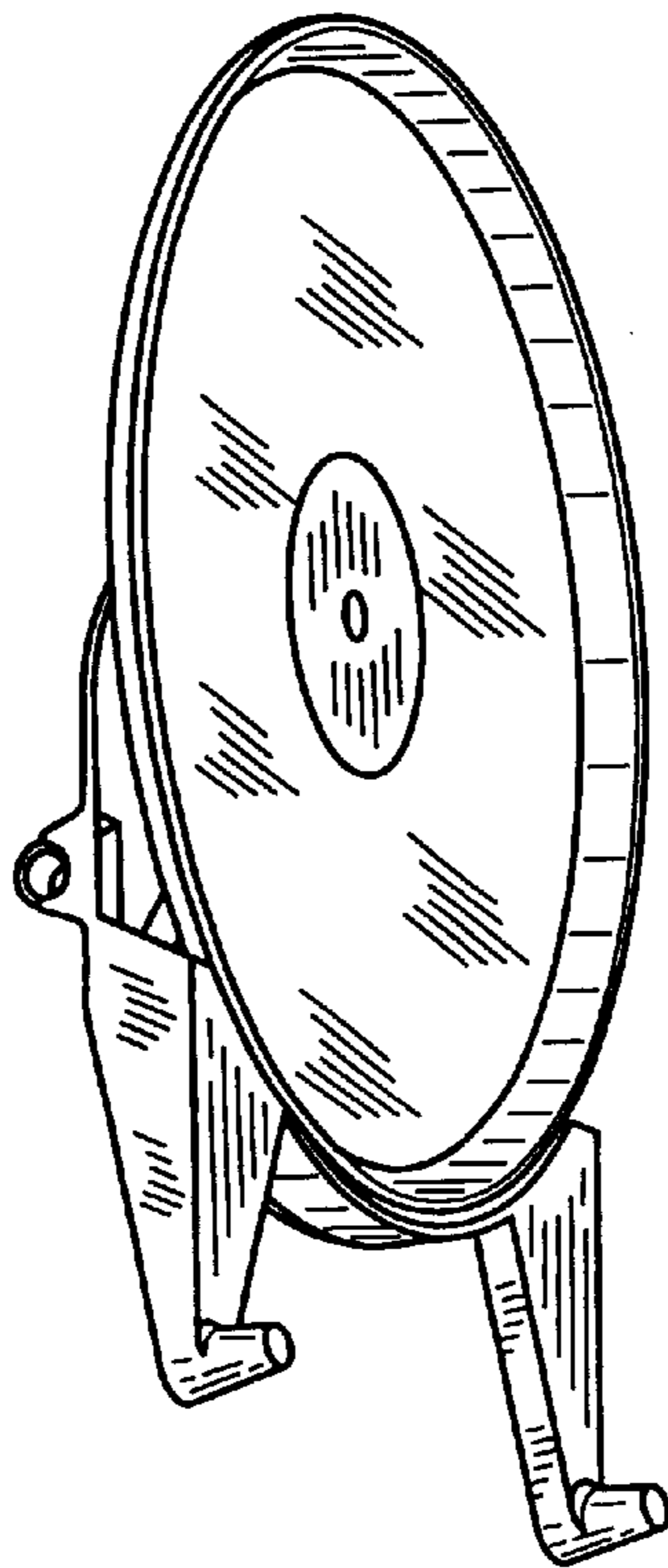
**FIG. 11**



**FIG. 12**



**FIG. 13**



**FIG. 14**