



US00D441025S

(12) **United States Design Patent**  
**Obata**

(10) **Patent No.:** **US D441,025 S**

(45) **Date of Patent:** **\*\* Apr. 24, 2001**

(54) **DISPLAY**

(75) Inventor: **Shinichi Obata**, Tokyo (JP)

(73) Assignee: **Sony Corporation**, Tokyo (JP)

(\*\*) Term: **14 Years**

(21) Appl. No.: **29/125,363**

(22) Filed: **Jun. 22, 2000**

(51) **LOC (7) Cl.** ..... **19-08**

(52) **U.S. Cl.** ..... **D20/10**

(58) **Field of Search** ..... D20/10, 39, 40,  
D20/42; D19/20, 21, 22; 40/1, 124, 124.1,  
124.2, 124.4, 156, 157, 158.1, 606, 615,  
616, 624

(56) **References Cited**

**U.S. PATENT DOCUMENTS**

D. 338,236 \* 8/1993 Lange ..... D20/10

D. 423,164 \* 4/2000 McKeown et al. .... D20/10

\* cited by examiner

*Primary Examiner*—Marcus A. Jackson

(74) *Attorney, Agent, or Firm*—Rader, Fishman & Grauer

(57) **CLAIM**

The ornamental design for a display, as shown and described.

**DESCRIPTION**

FIG. 1 is a perspective view of a display showing my new design;

FIG. 2 is a top plan view thereof;

FIG. 3 is a bottom plan view thereof;

FIG. 4 is a left side elevational view thereof;

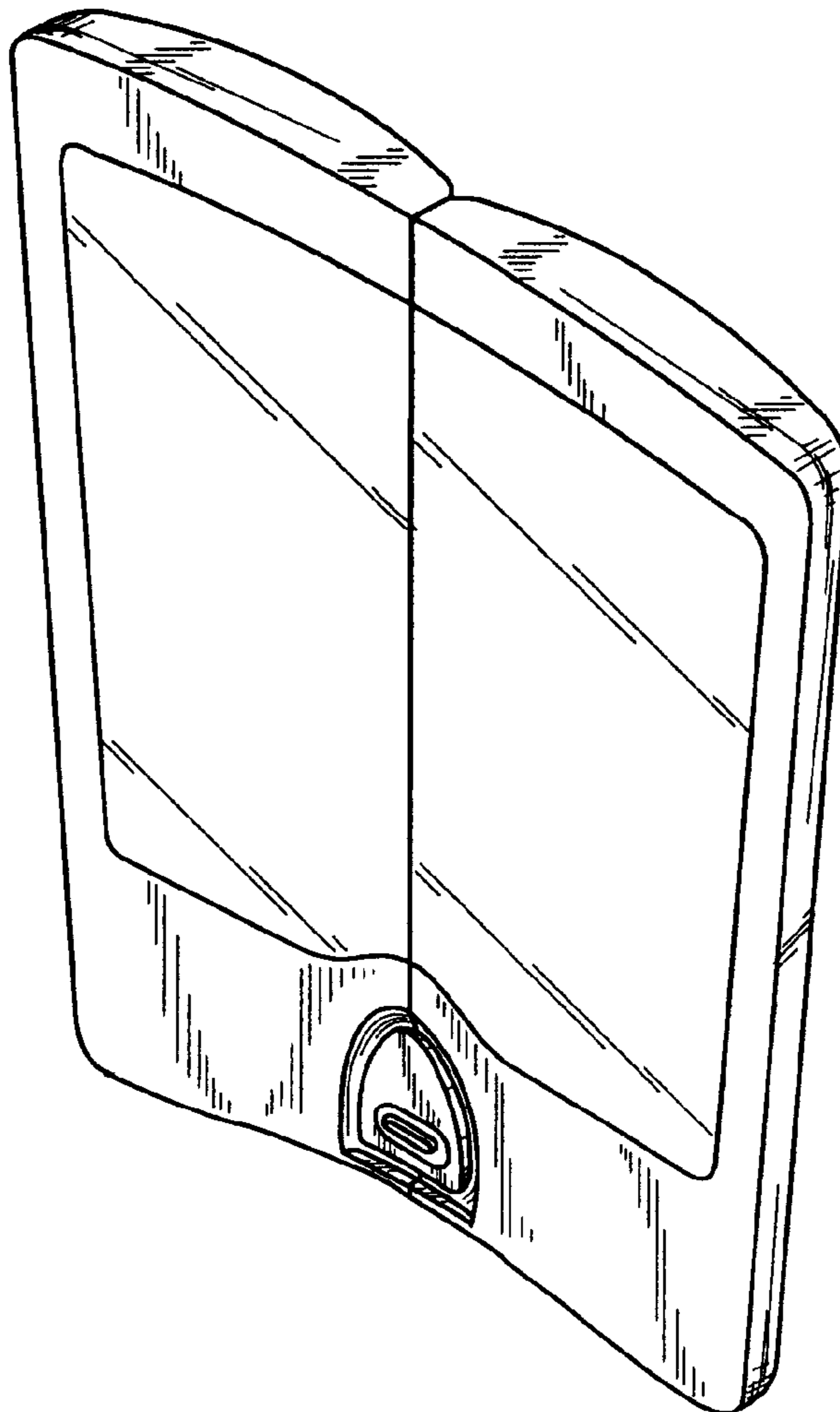
FIG. 5 is a right side elevational view thereof;

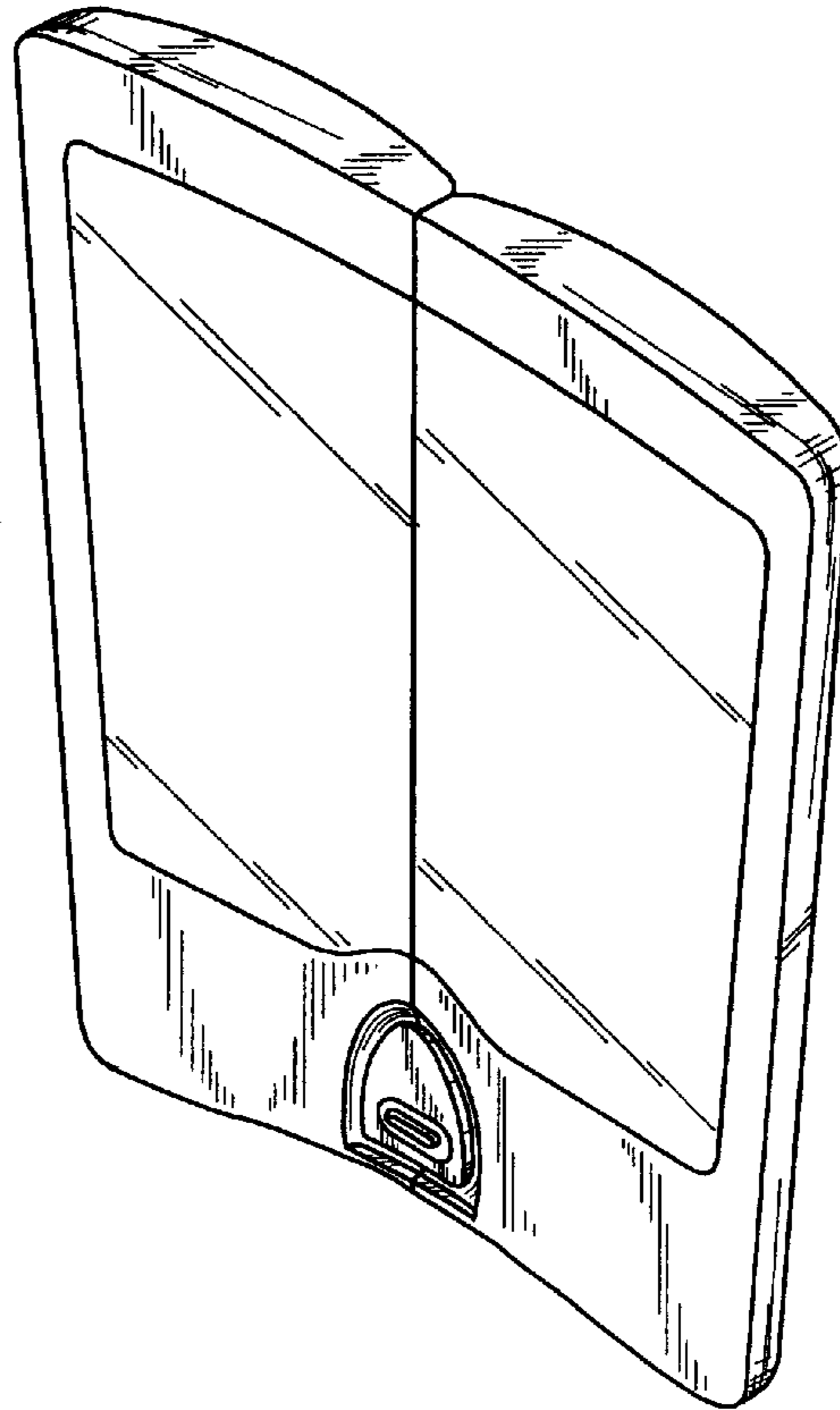
FIG. 6 is a front elevational view thereof; and

FIG. 7 is a rear elevational view thereof; and,

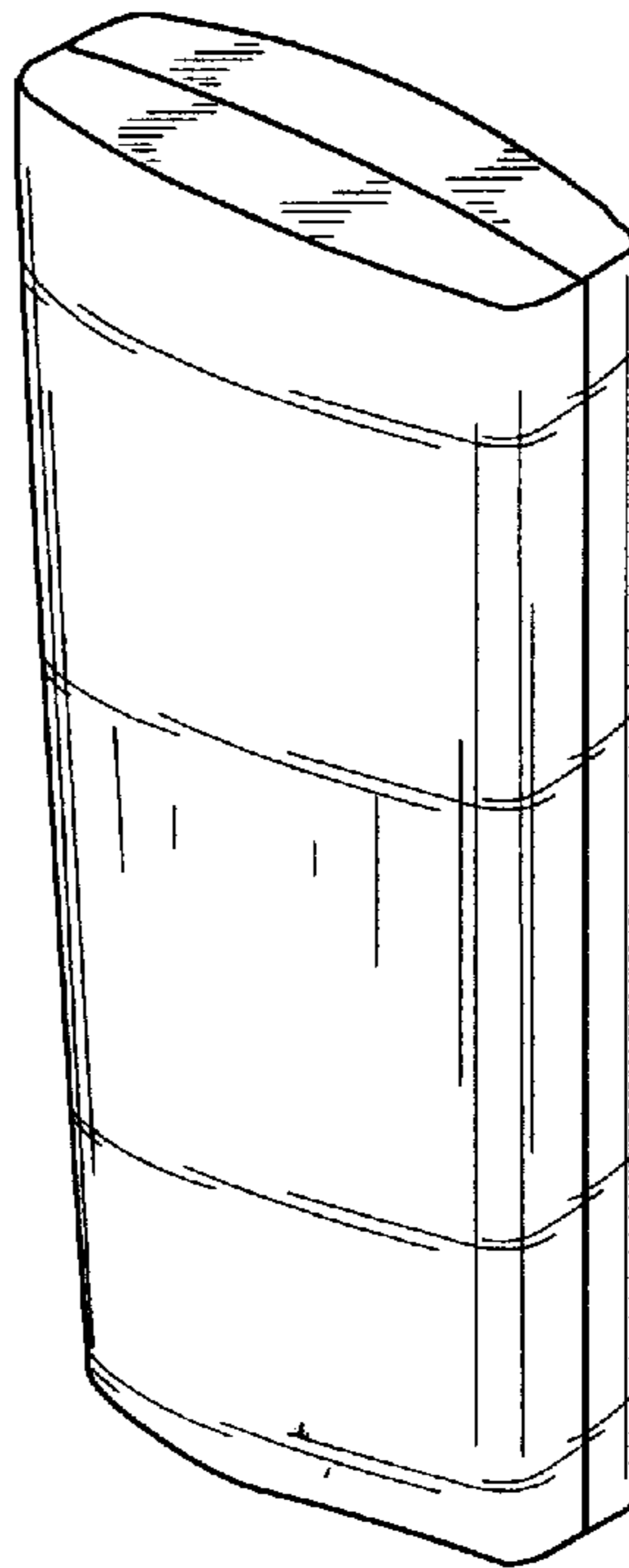
FIG. 8 is a reference perspective view thereof in the closed position.

**1 Claim, 4 Drawing Sheets**

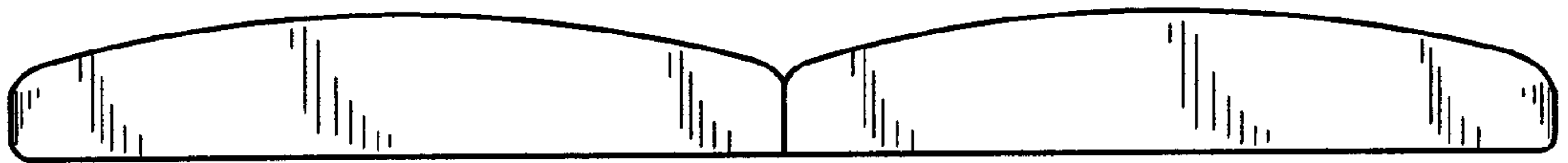




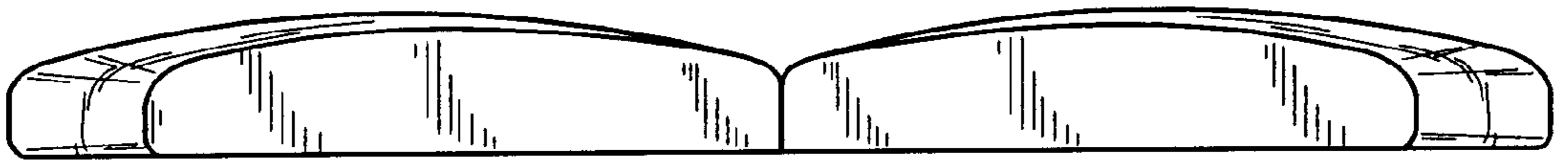
**Fig. 1**



**Fig. 8**



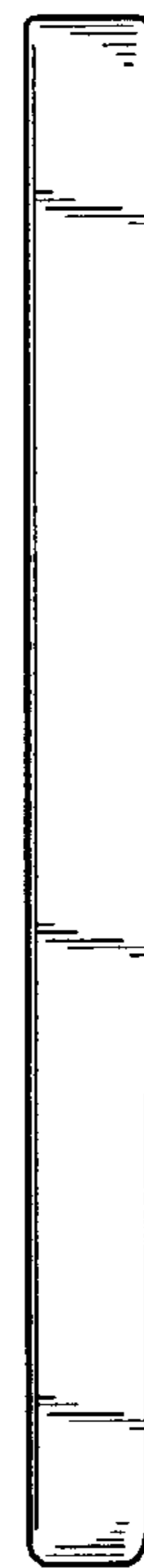
**Fig. 2**



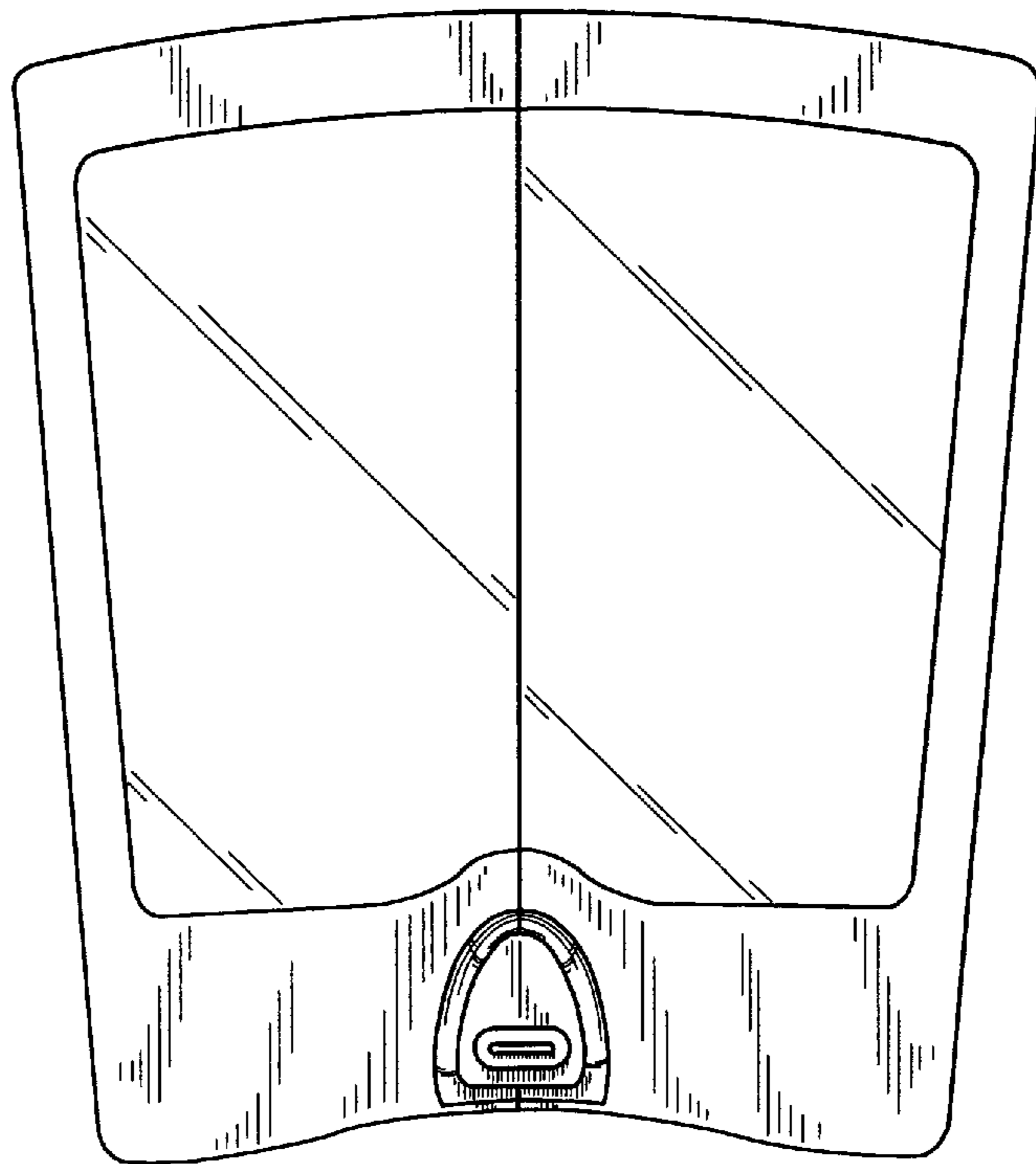
**Fig. 3**



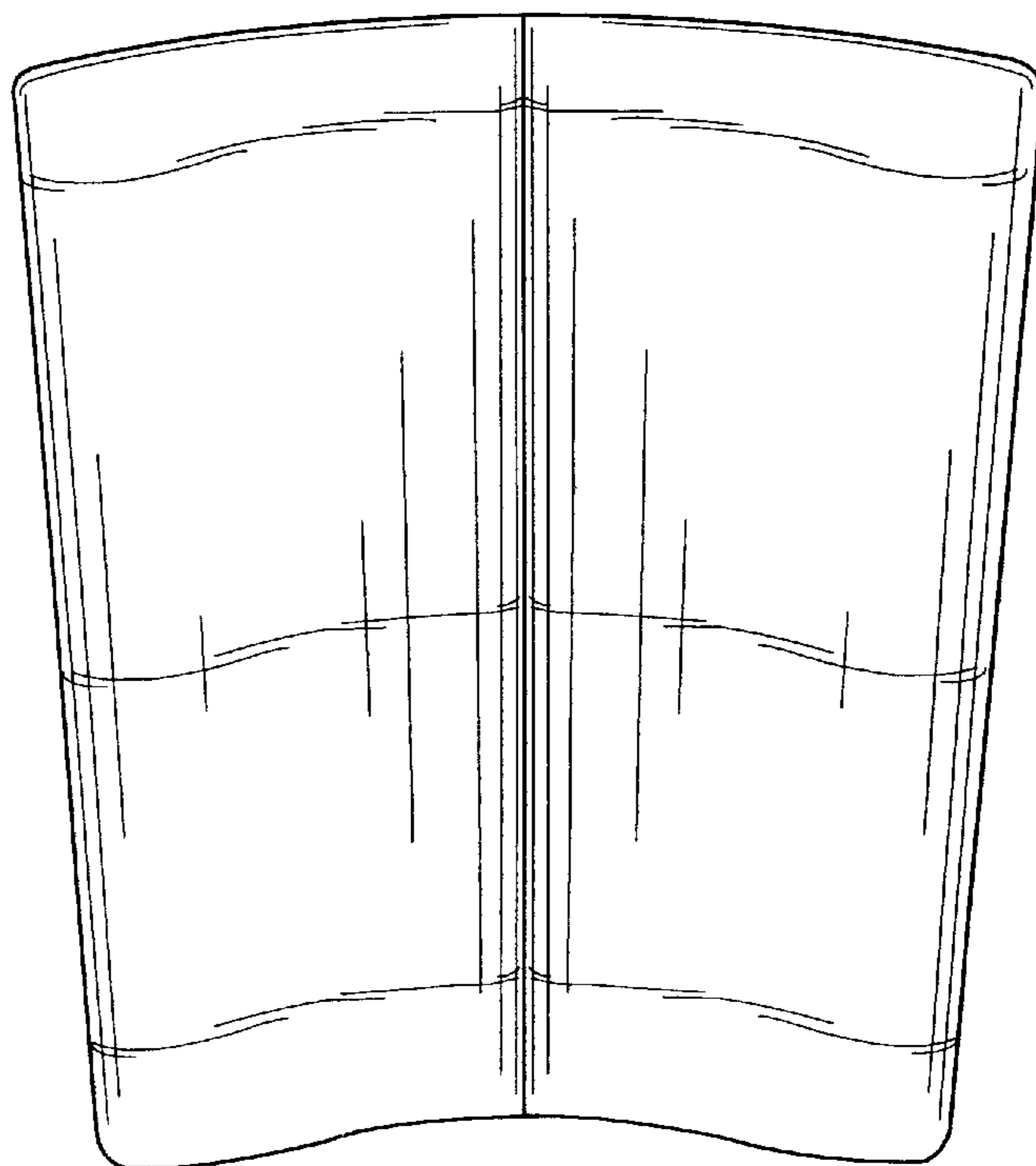
**Fig. 4**



**Fig. 5**



**Fig. 6**



**Fig. 7**