



US00D441012S

(12) **United States Design Patent**
Kawahara et al.

(10) **Patent No.:** **US D441,012 S**

(45) **Date of Patent:** **** Apr. 24, 2001**

(54) **INKJET PRINTER**

(75) Inventors: **Manabu Kawahara; Yoshihiro Tatara; Masahiko Kobayashi; Kazuhiro Miyoshi; Hiromi Shishiuchi; Keisuke Inoue; Takeo Kishida**, all of Nagano-ken (JP)

(73) Assignee: **Seiko Epson Corporation, Tokyo (JP)**

(**) Term: **14 Years**

(21) Appl. No.: **29/120,950**

(22) Filed: **Mar. 30, 2000**

(30) **Foreign Application Priority Data**

Sep. 30, 1999 (JP) 11-26355

(51) **LOC (7) Cl.** **18-02**

(52) **U.S. Cl.** **D18/55**

(58) **Field of Search** D18/50, 54-55;
D14/462-470; 400/613, 613.1-613.4, 690.1-690.4,
691-694

(56) **References Cited**

U.S. PATENT DOCUMENTS

D. 378,378 * 3/1997 Nakazawa et al. D18/54

D. 379,827 * 6/1997 Andre D18/54

D. 390,258 * 2/1998 Kawahara et al. D18/55
D. 393,870 * 4/1998 Kobayashi et al. D18/55
D. 400,918 * 11/1998 Kobayashi et al. D18/55
D. 411,228 * 6/1999 Kobayashi et al. D18/50
D. 430,894 * 9/2000 Inoue D18/54
D. 433,442 * 11/2000 Clark, III D18/55

* cited by examiner

Primary Examiner—Cathy Anne MacCormac

(74) *Attorney, Agent, or Firm*—Sughrue, Mion, Zinn, Macpeak & Seas, PLLC

(57) **CLAIM**

The ornamental design for an inkjet printer, as shown and described.

DESCRIPTION

FIG. 1 is a perspective view of the top, front and right side of an inkjet printer showing our new design;
FIG. 2 is a front elevational view thereof;
FIG. 3 is a rear elevational view thereof;
FIG. 4 is a top plan view thereof;
FIG. 5 is a right side elevational view thereof;
FIG. 6 is a left side elevational view thereof;
FIG. 7 is a bottom plan view thereof; and,
FIG. 8 is a perspective view similar to FIG. 1 with paper guiding sheets in the extended positions.

1 Claim, 6 Drawing Sheets

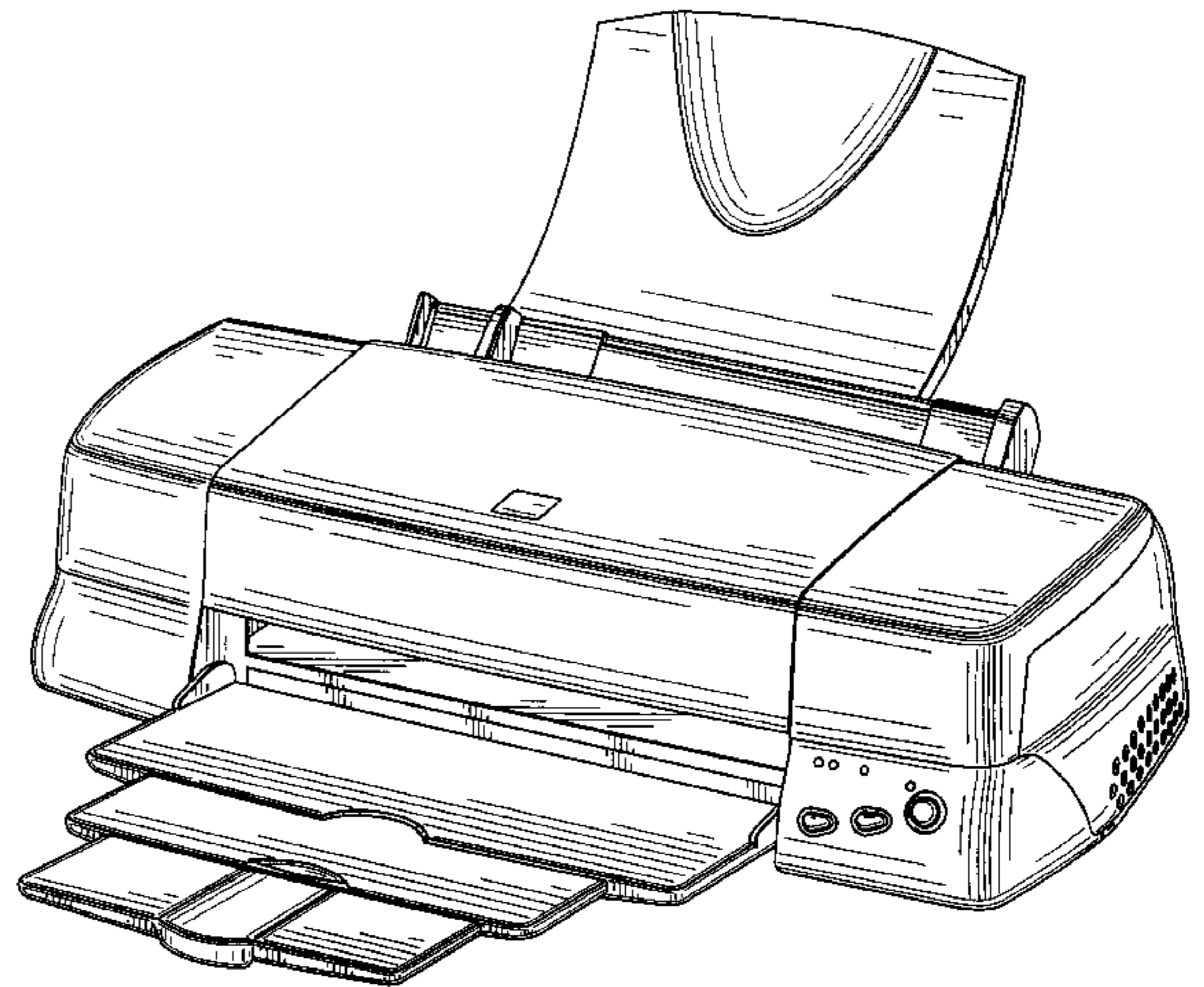
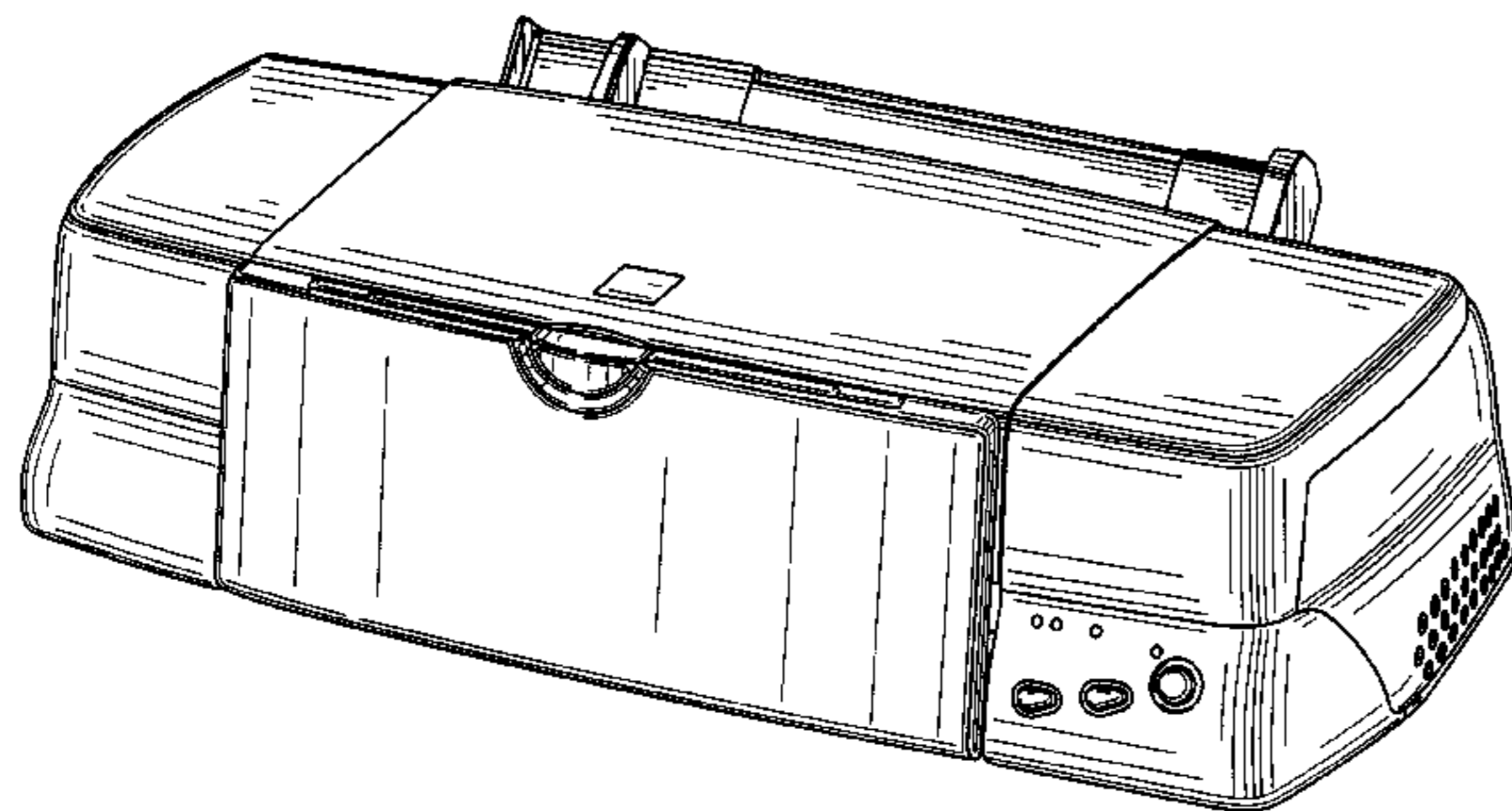

FIG. 1

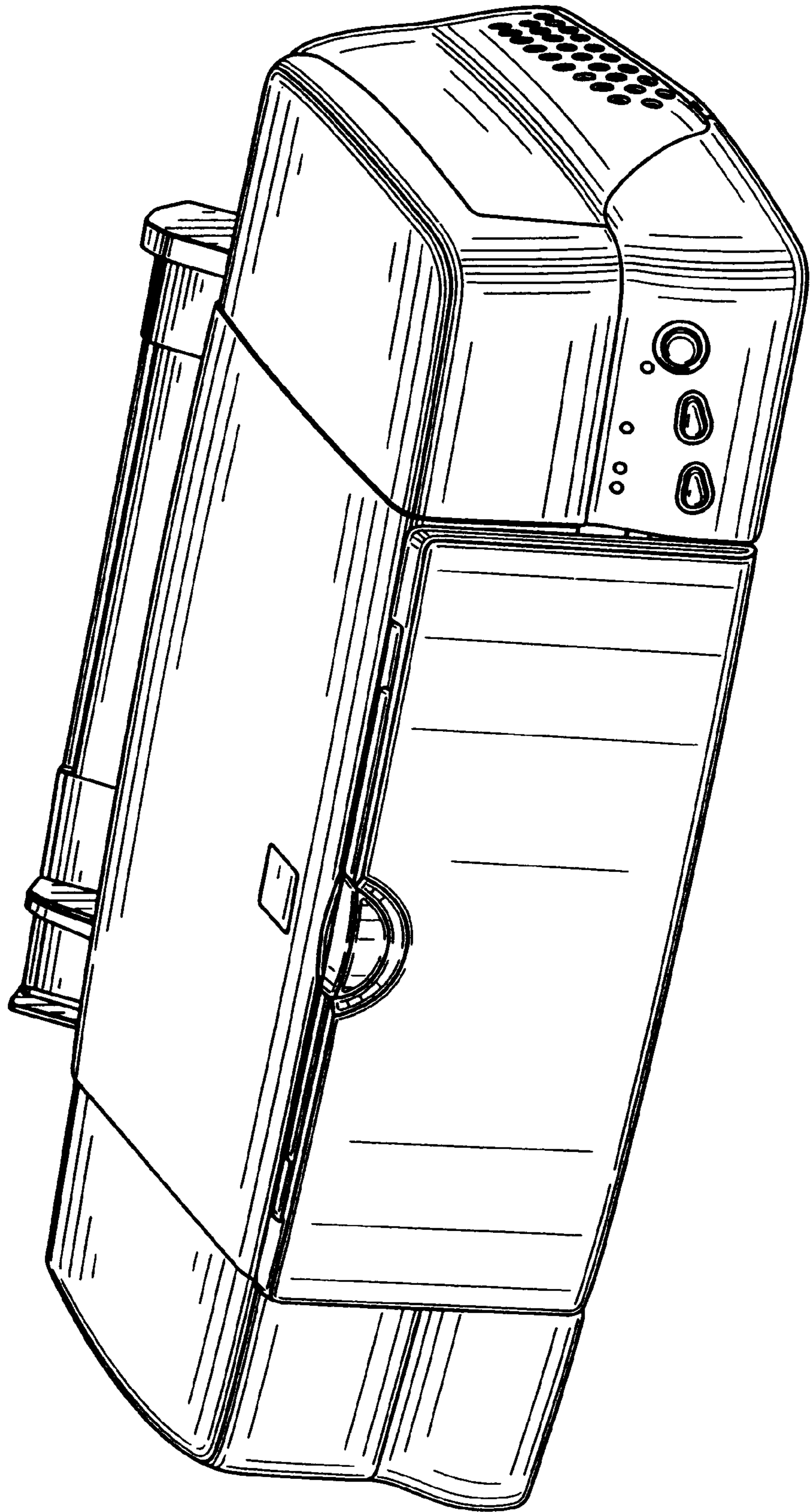

FIG. 2

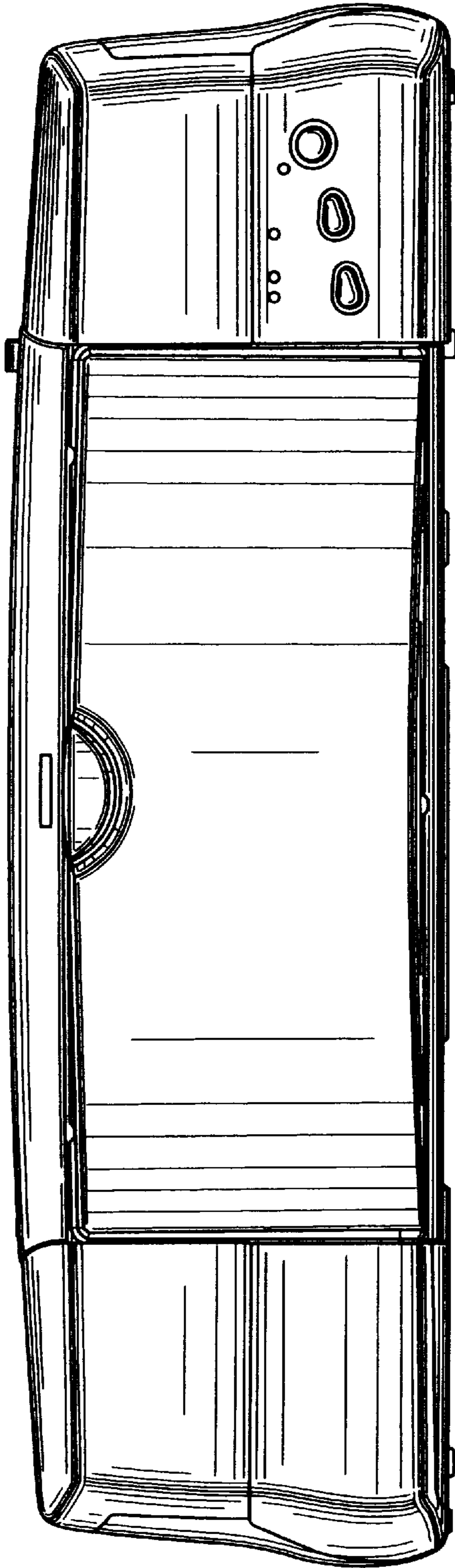

FIG. 3

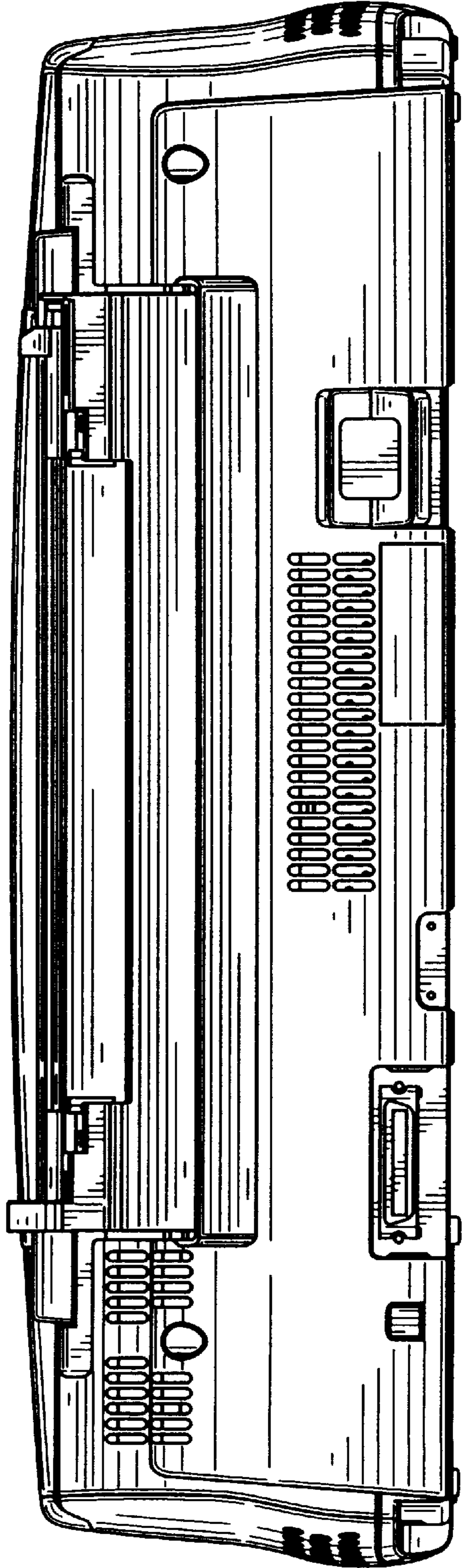

FIG. 4

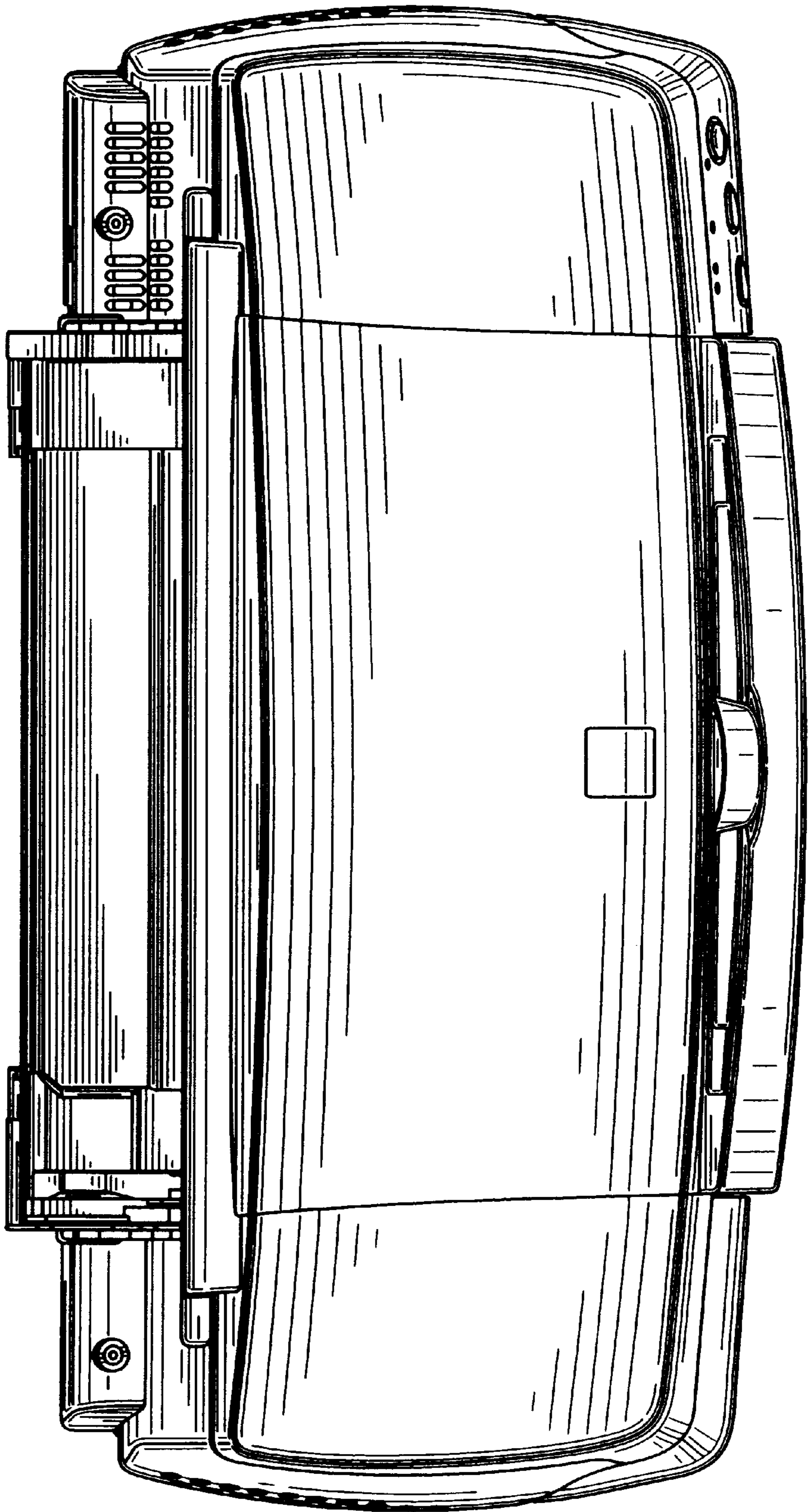

FIG. 5

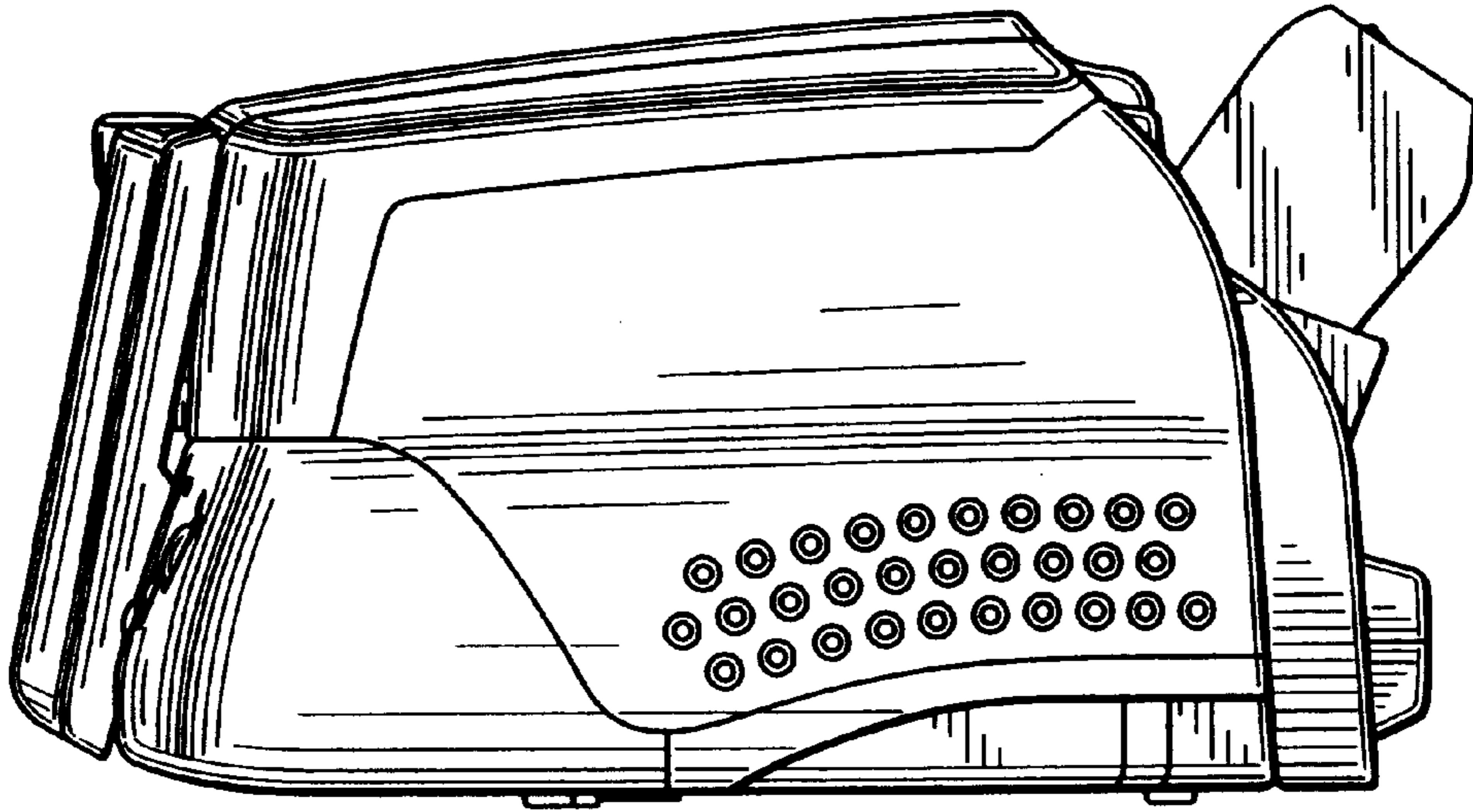

FIG. 6

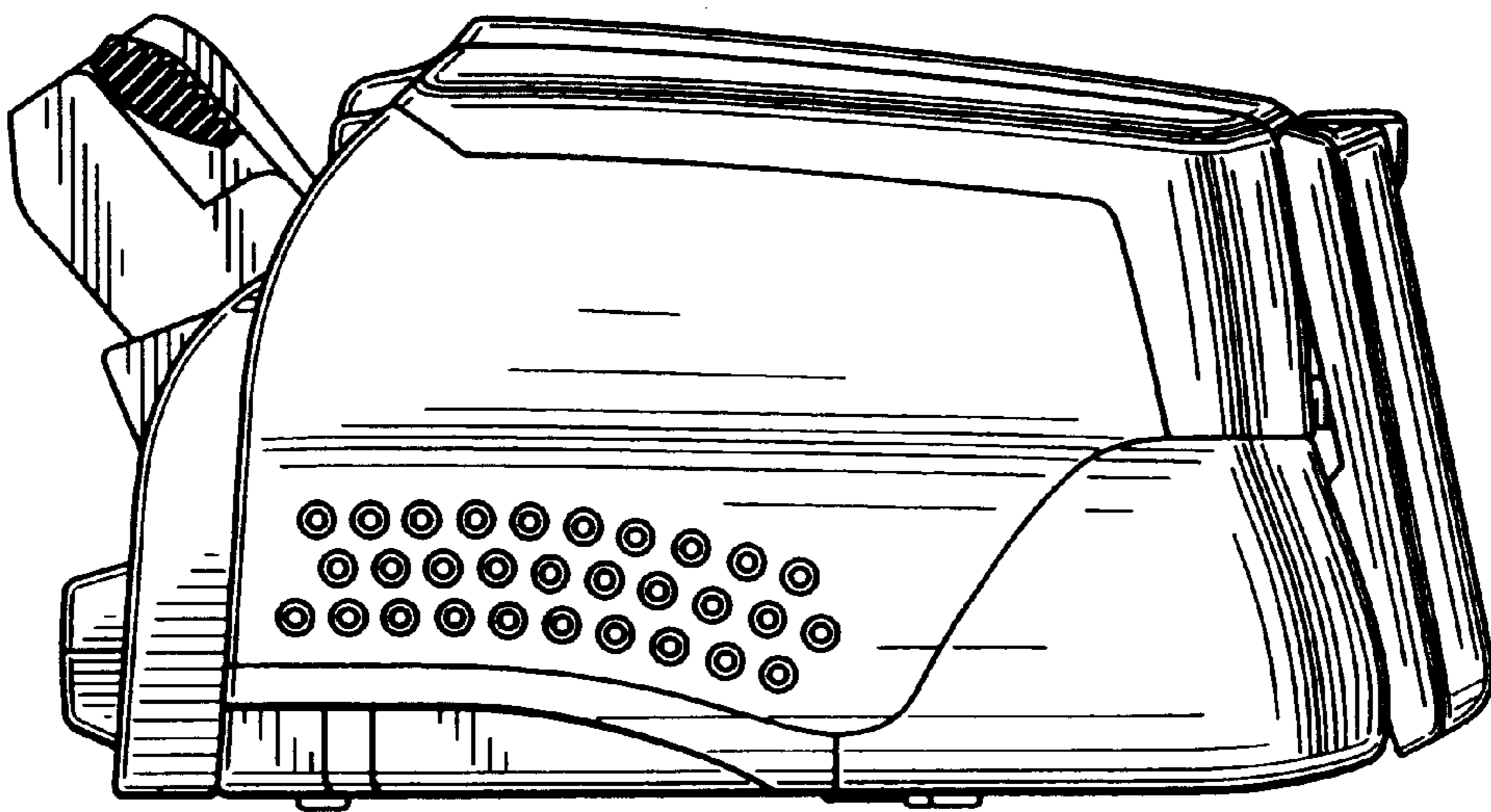
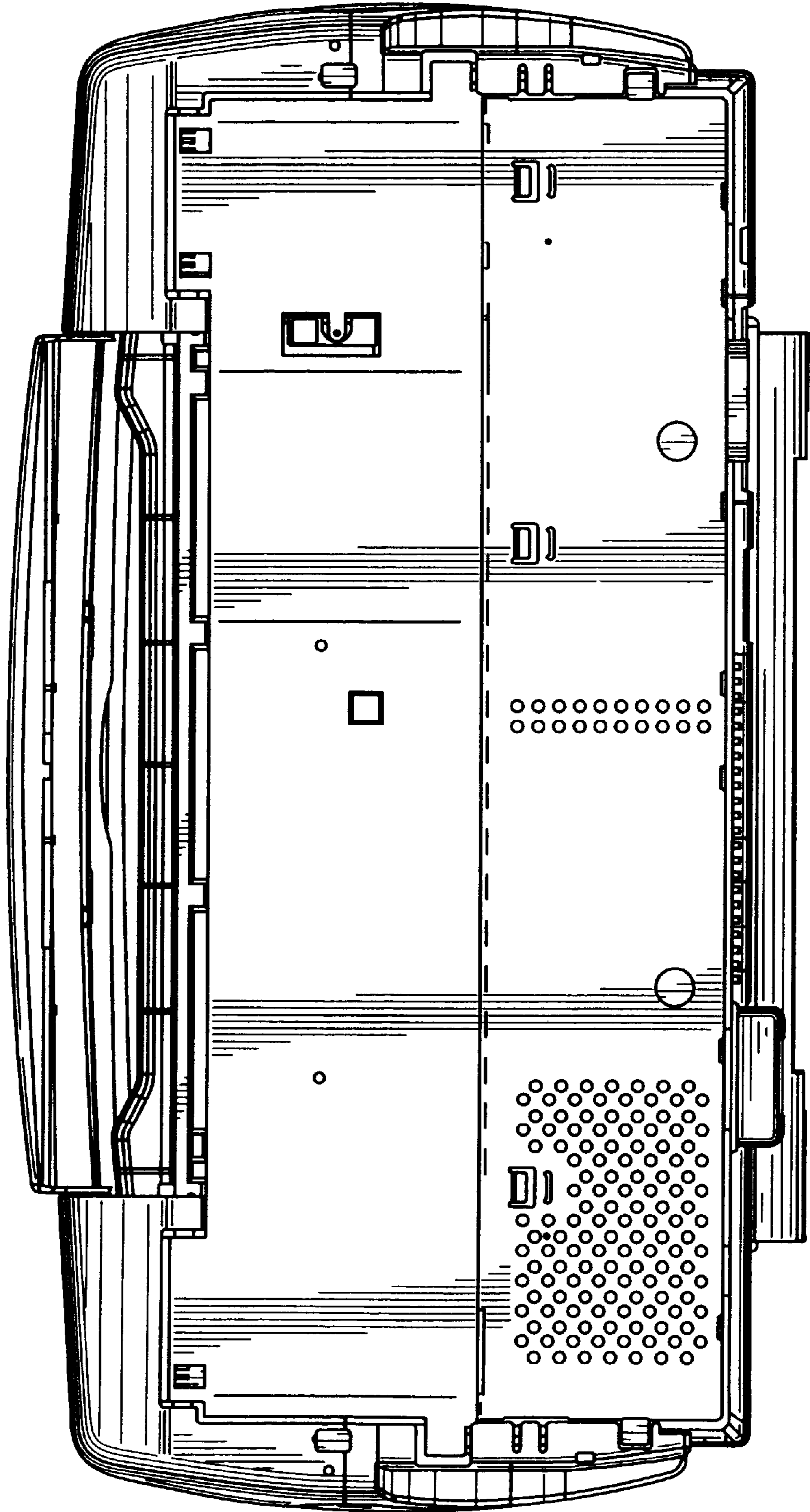

FIG. 7



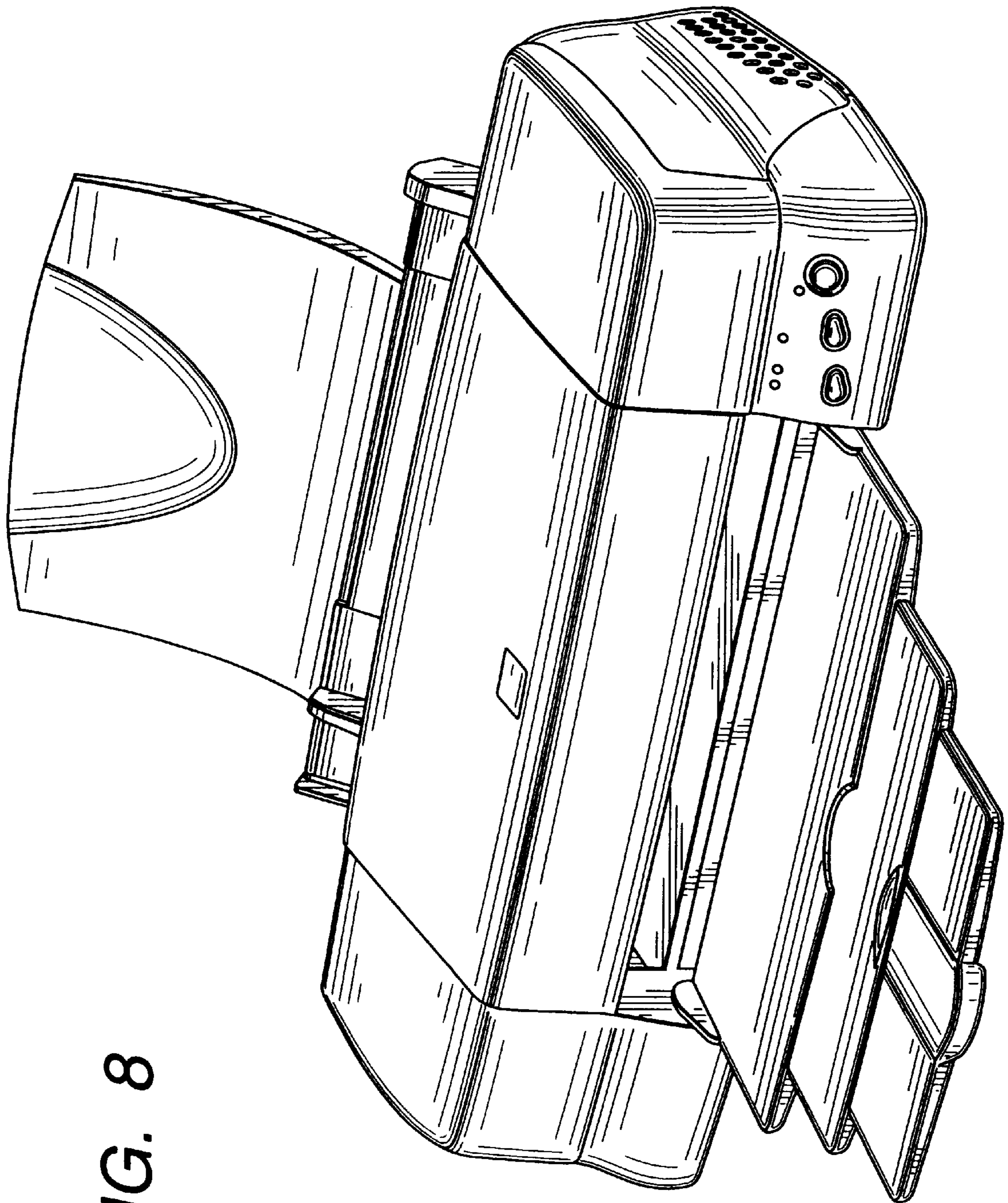

FIG. 8