



US00D440908S

(12) **United States Design Patent**
Ikeda et al.

(10) **Patent No.:** **US D440,908 S**

(45) **Date of Patent:** **** Apr. 24, 2001**

(54) **VEHICLE BODY**

(75) Inventors: **Jon Y. Ikeda**, Long Beach; **William Yex**, Redondo Beach, both of CA (US)

(73) Assignee: **Honda Giken Gogyo Kabushiki Kaisha**, Tokyo (JP)

(**) Term: **14 Years**

(21) Appl. No.: **29/125,508**

(22) Filed: **Jun. 26, 2000**

(51) **LOC (7) Cl.** **12-08**

(52) **U.S. Cl.** **D12/92**

(58) **Field of Search** D12/90-92; 296/185

(56) **References Cited**

U.S. PATENT DOCUMENTS

D. 402,232 * 12/1998 Haguchi et al. D12/92

D. 410,595 * 1/1999 Sacco et al. D12/92

D. 433,653 * 11/2000 Sacco et al. D12/92

* cited by examiner

Primary Examiner—Melody N. Brown

(74) *Attorney, Agent, or Firm*—Banner & Witcoff, Ltd.

(57) **CLAIM**

The ornamental design for a vehicle body, as shown and described.

DESCRIPTION

FIG. 1 is a front and right side perspective view of a vehicle body showing our new design;

FIG. 2 is a rear perspective view thereof;

FIG. 3 is a right side elevational view thereof;

FIG. 4 is a left side elevational view thereof;

FIG. 5 is a front elevational view thereof;

FIG. 6 is a rear elevational view thereof; and,

FIG. 7 is a top plan view thereof.

The broken line showing of the roof panel, the exterior door handle, the generally square panel on the left side and the wheels is for illustrative purposes only and forms no part of the claimed design. The unshown bottom of the vehicle forms no part of the claimed design.

1 Claim, 5 Drawing Sheets

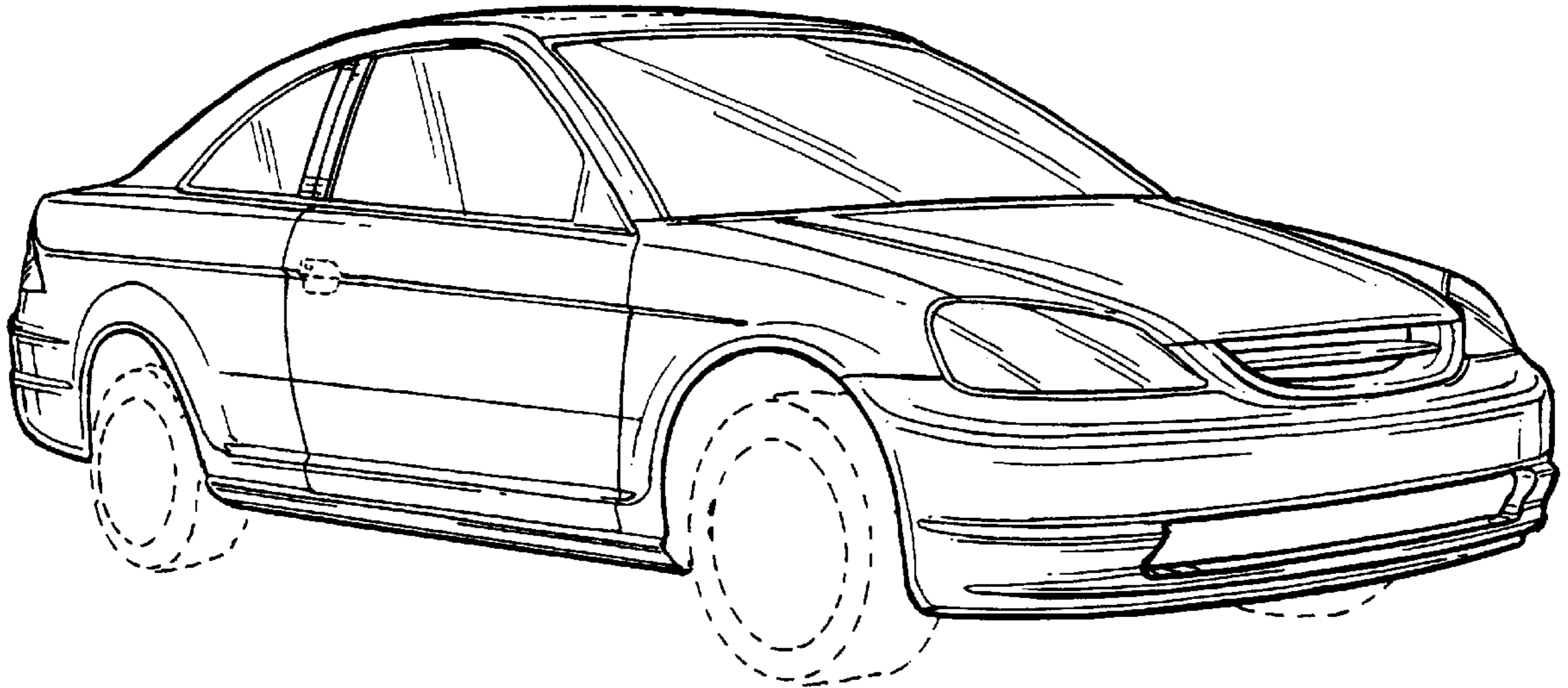

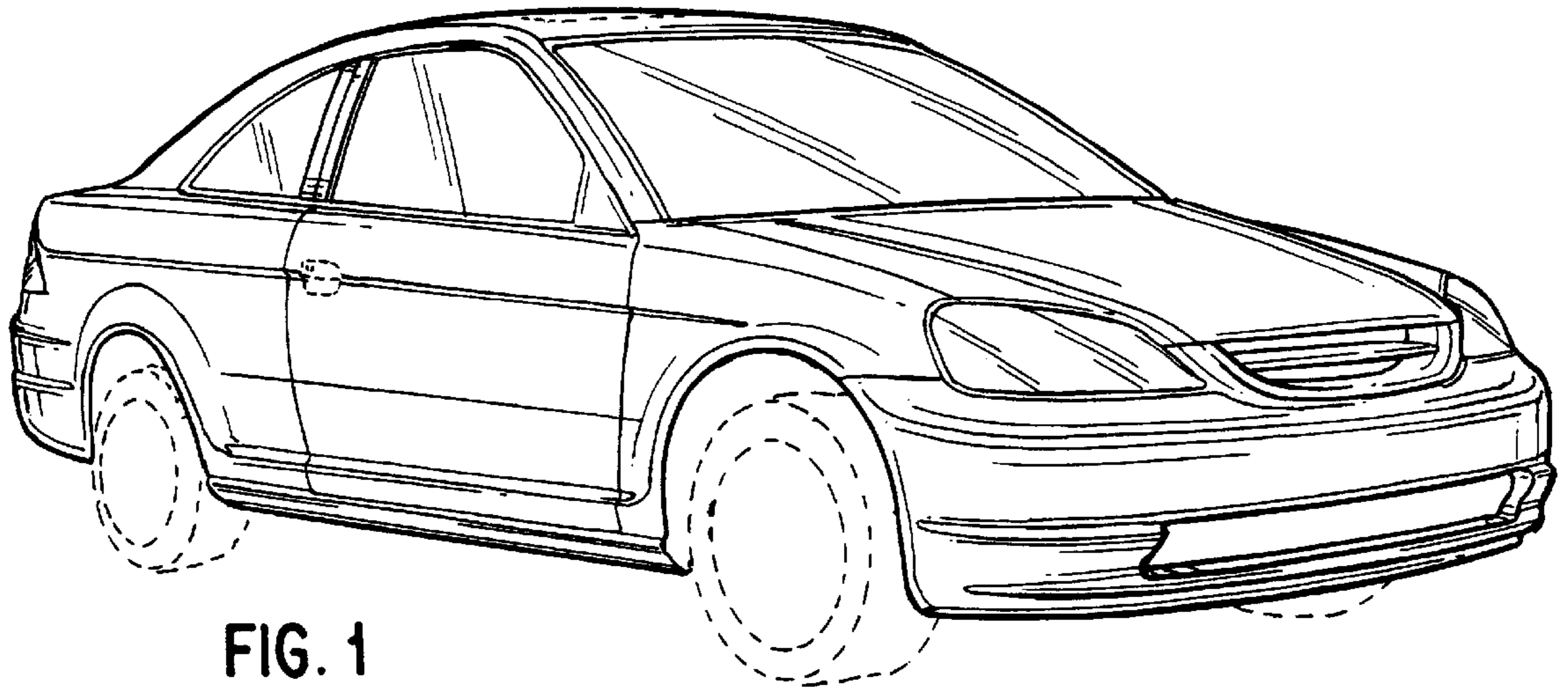

FIG. 1

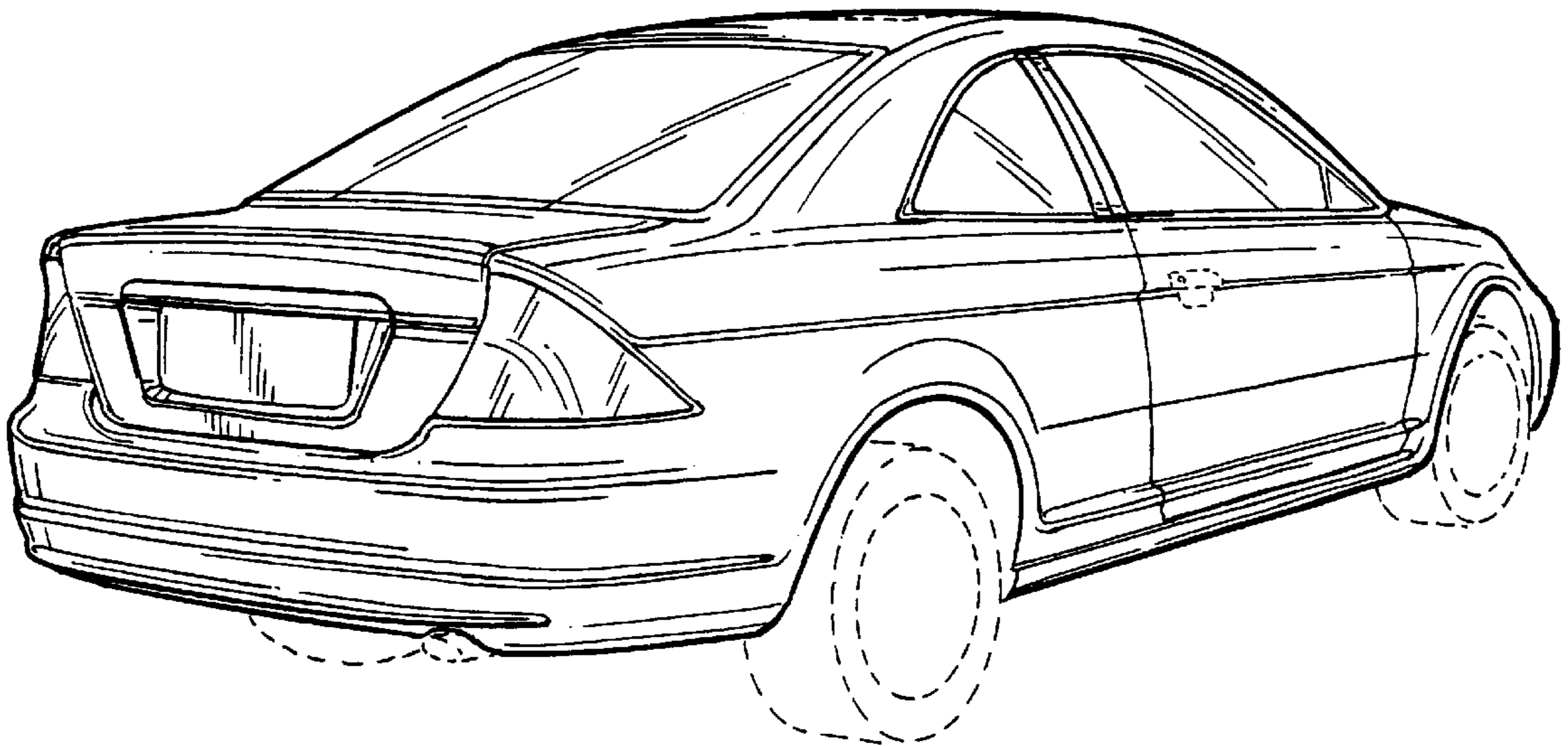

FIG. 2

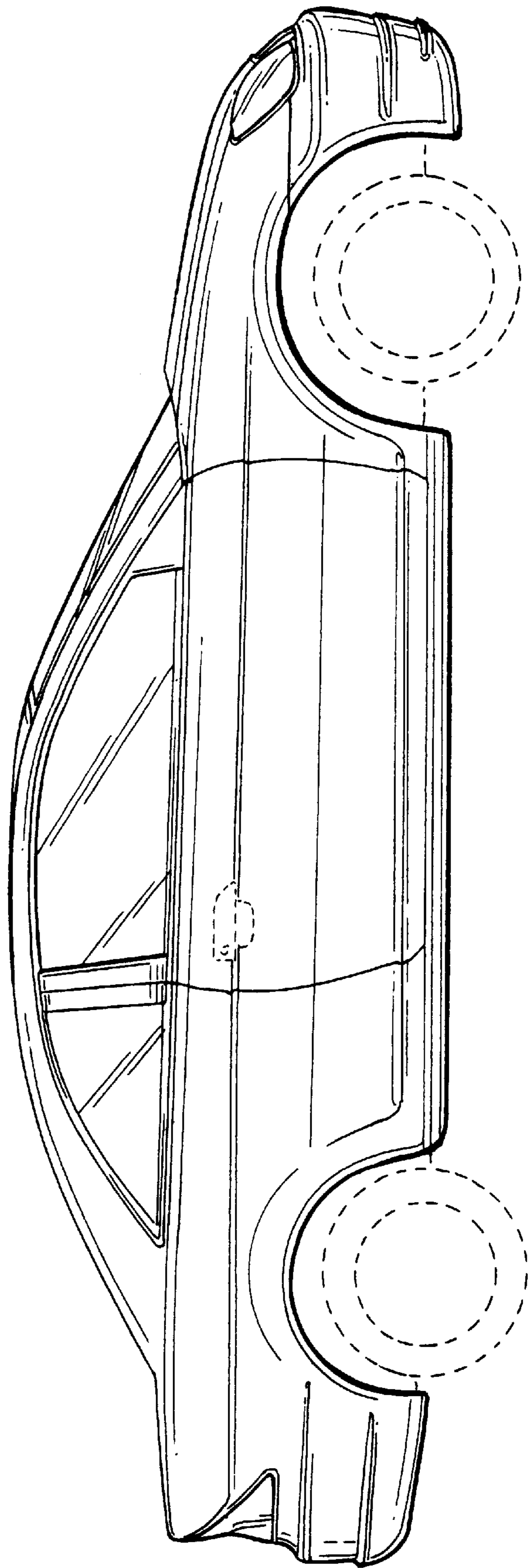

FIG. 3

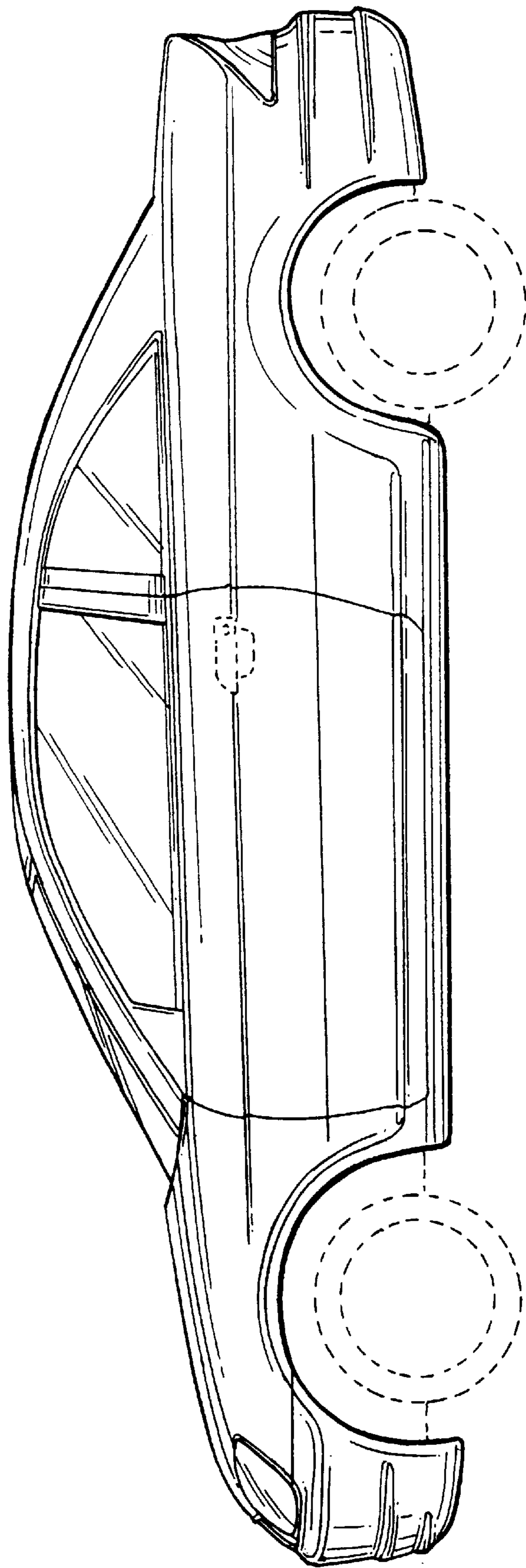

FIG. 4

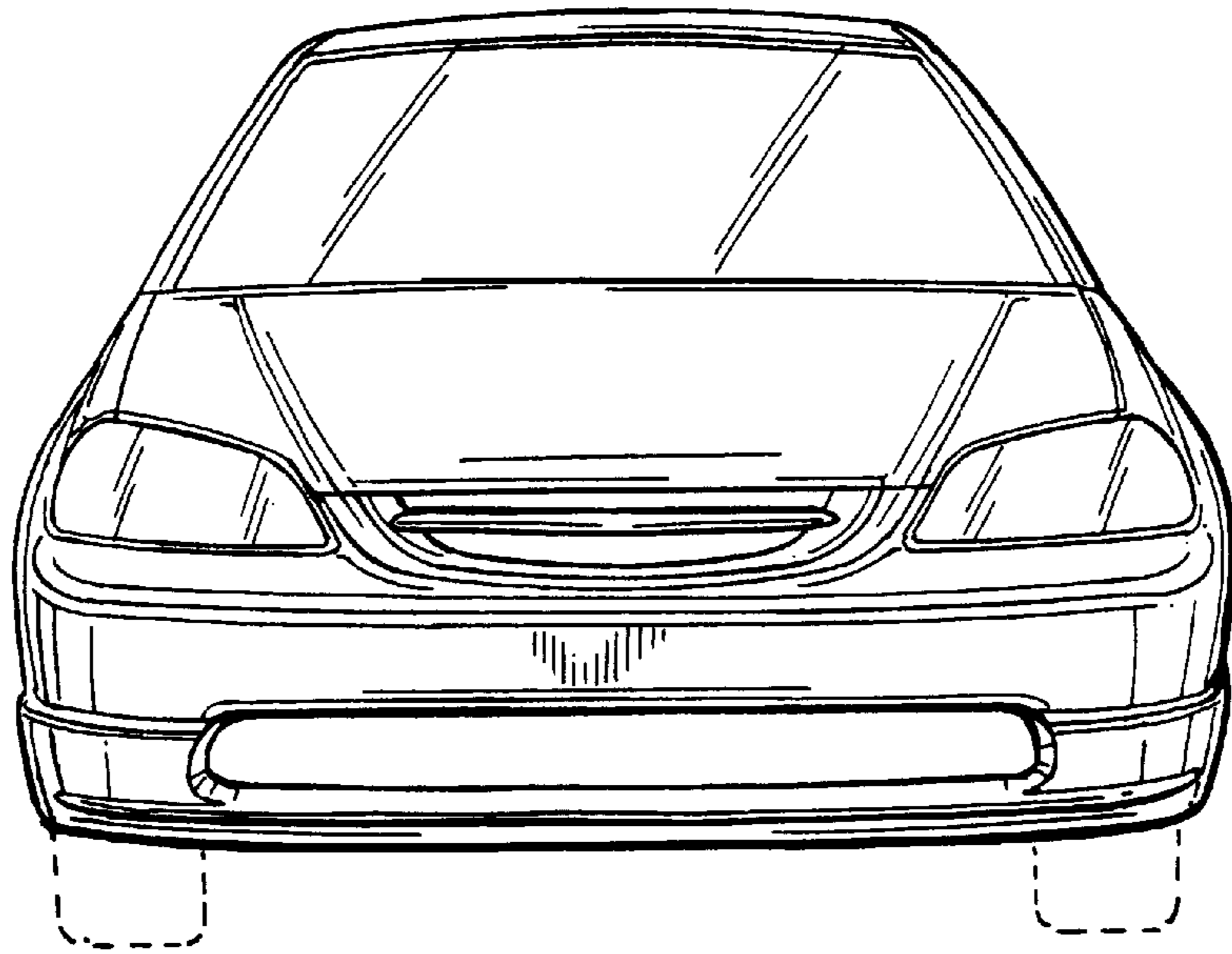

FIG. 5

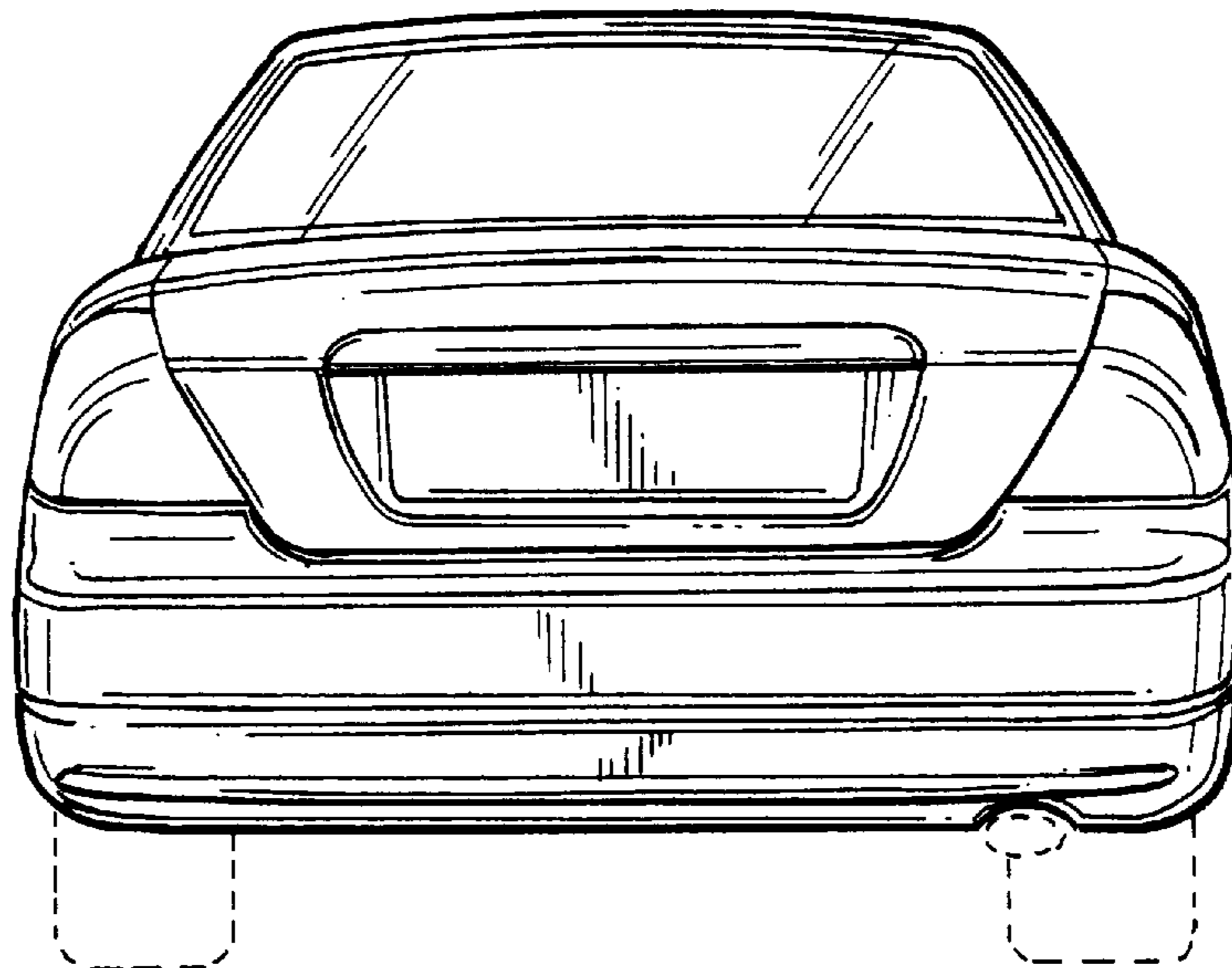

FIG. 6

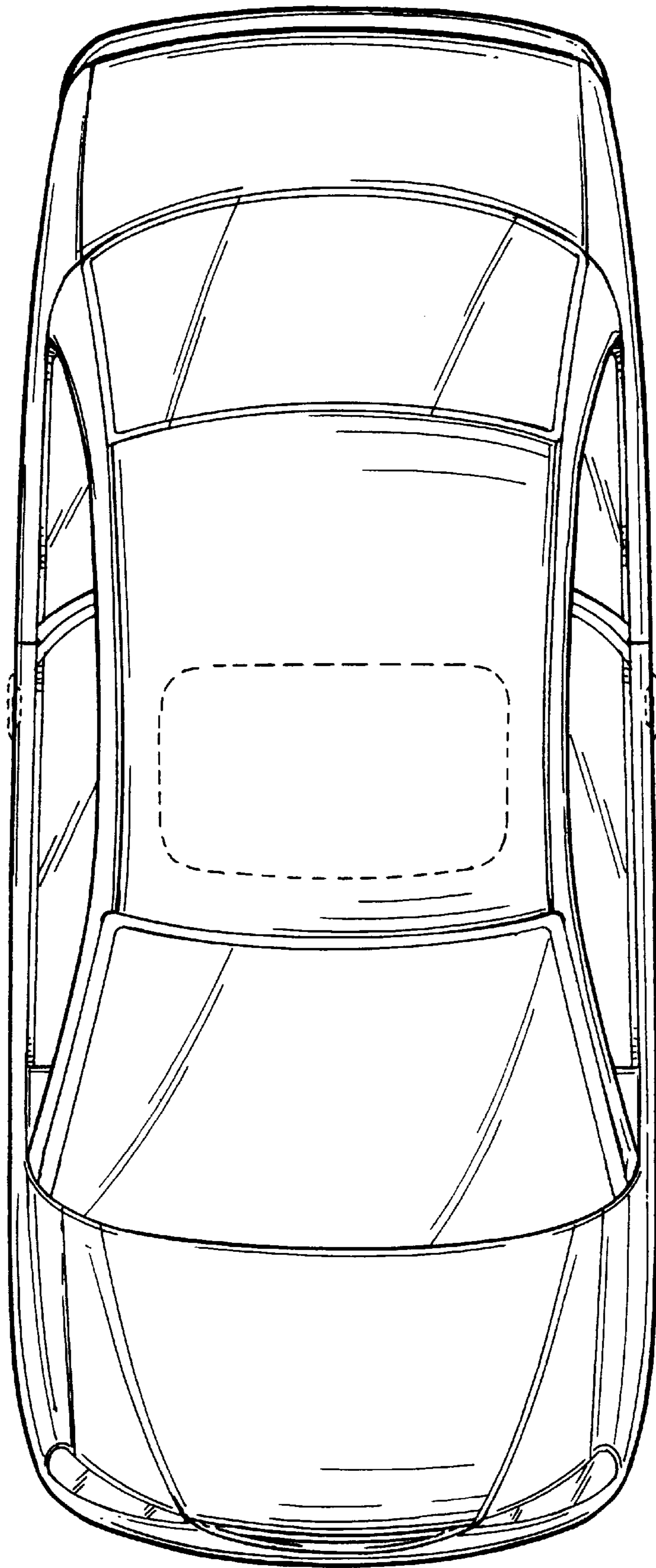

FIG. 7