



US00D440860S

(12) **United States Design Patent**  
**Magnusson**

(10) **Patent No.:** **US D440,860 S**

(45) **Date of Patent:** **\*\* Apr. 24, 2001**

(54) **LOCK**

5,897,147 \* 4/1999 Alvanakian et al. .

(76) Inventor: **Claes Magnusson**, 23 McKay Road,  
Wimbledon, SW20 OHT London (GB)

\* cited by examiner

(\*\*) Term: **14 Years**

*Primary Examiner*—B. J. Bullock

(74) *Attorney, Agent, or Firm*—Birch, Stewart, Kolasch &  
Birch, LLP

(21) Appl. No.: **29/125,742**

(57) **CLAIM**

(22) Filed: **Jun. 30, 2000**

The ornamental design for a lock, as shown and described.

(51) **LOC (7) Cl.** ..... **08-07**

**DESCRIPTION**

(52) **U.S. Cl.** ..... **D8/341; D8/313**

(58) **Field of Search** ..... D8/300, 339, 341,  
D8/313, 314; 16/412; 70/95, 96, 99, 100,  
97, DIG. 80; 292/336.3, DIG. 46, 137,  
138, 150

FIG. 1 is a perspective view of a lock showing my new design;

FIG. 2 is a rear elevational view thereof;

FIG. 3 is a bottom view thereof;

FIG. 4 is a right side elevational view thereof;

FIG. 5 is a front elevational view thereof;

FIG. 6 is a left side elevational view thereof; and,

FIG. 7 is a top plan view thereof.

The broken lines are for illustrative purposes only and form no part of the claimed design.

(56) **References Cited**

**U.S. PATENT DOCUMENTS**

D. 210,152	*	2/1968	Pastva, Jr.	.....	D8/341
2,840,407	*	6/1958	Sellon, Jr.	.	
2,842,951	*	7/1958	Dovall	.	
4,746,152	*	5/1988	Willcox	.....	292/150

**1 Claim, 1 Drawing Sheet**

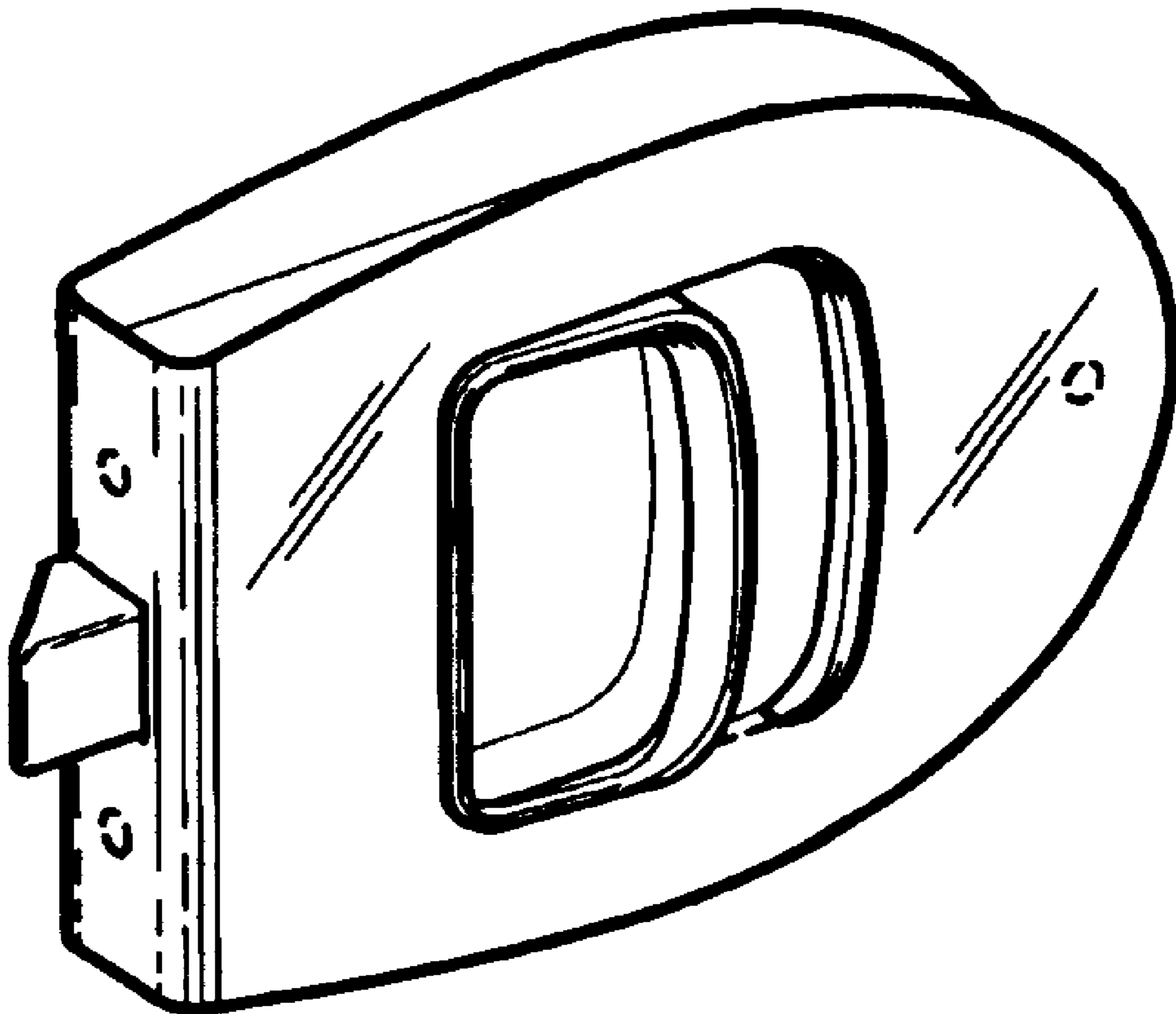

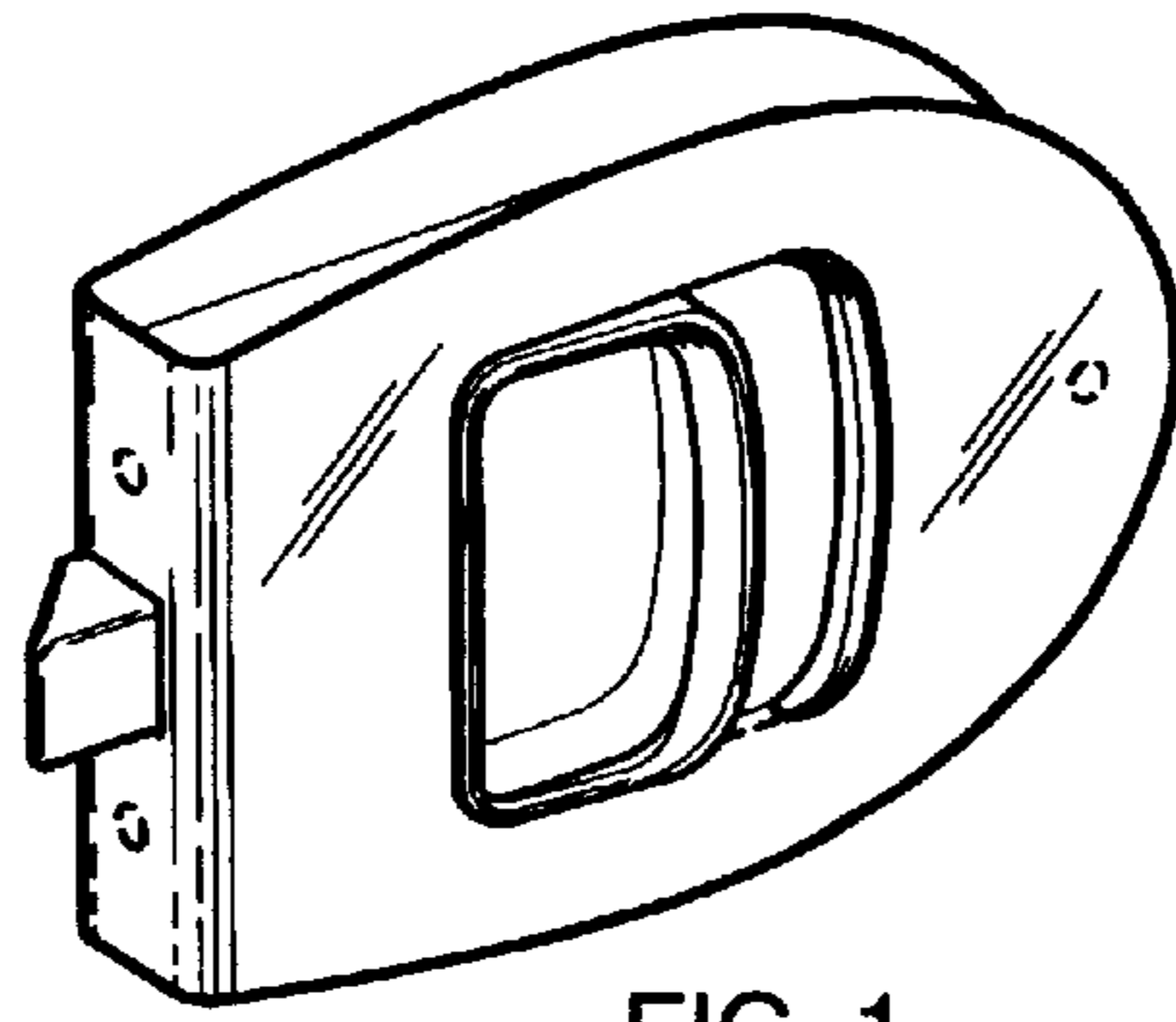

FIG. 1

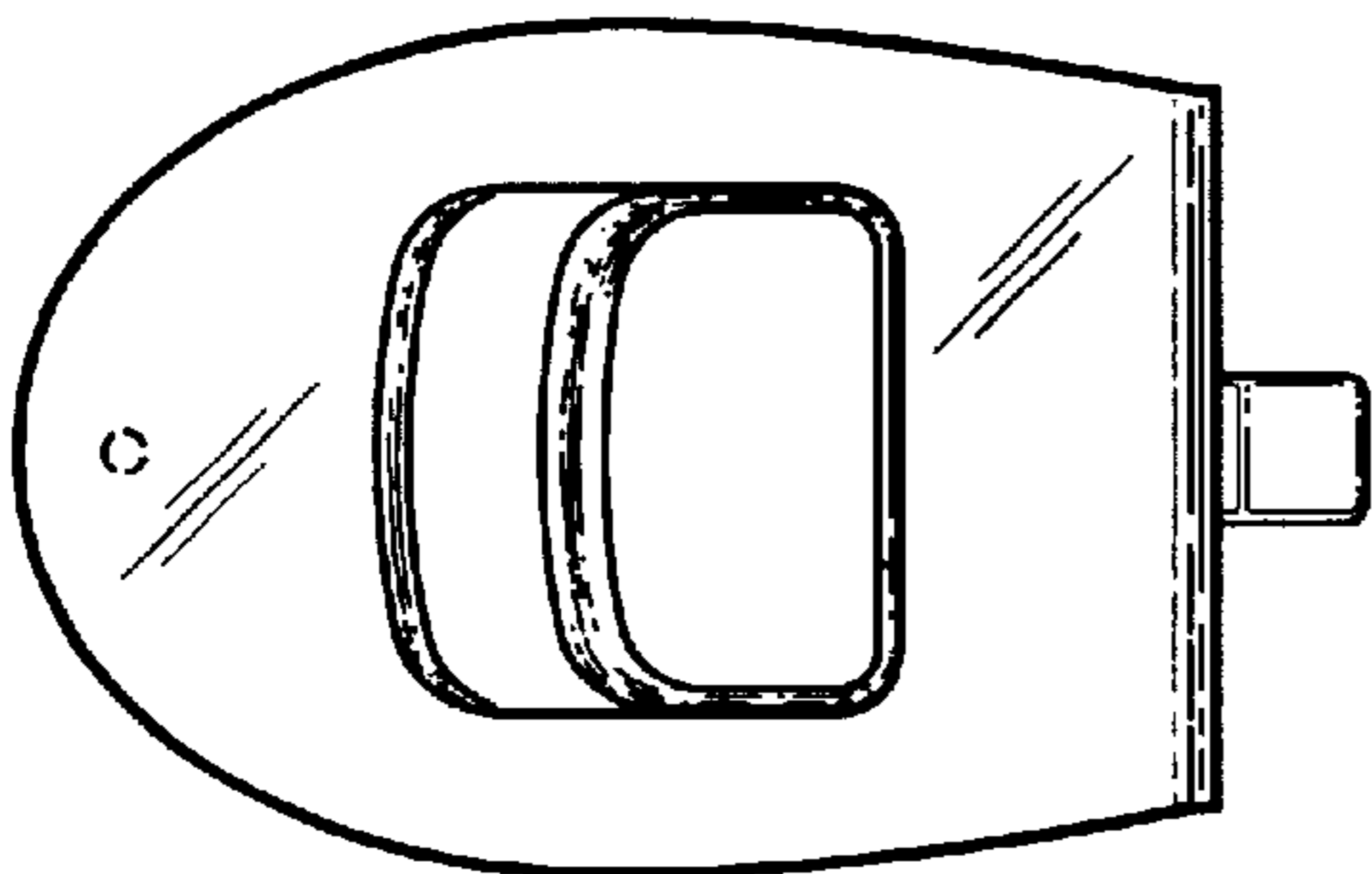

FIG. 2



FIG. 3

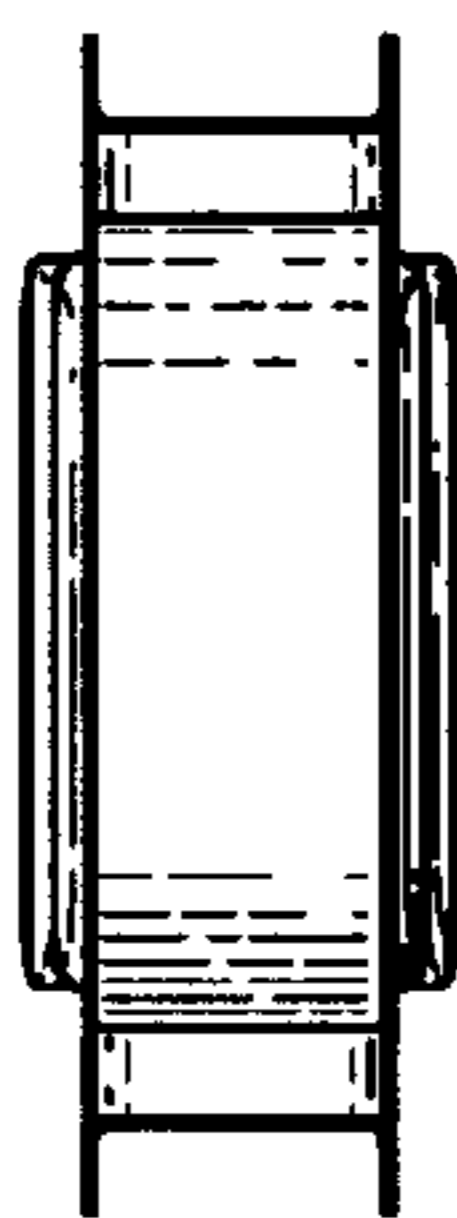

FIG. 4

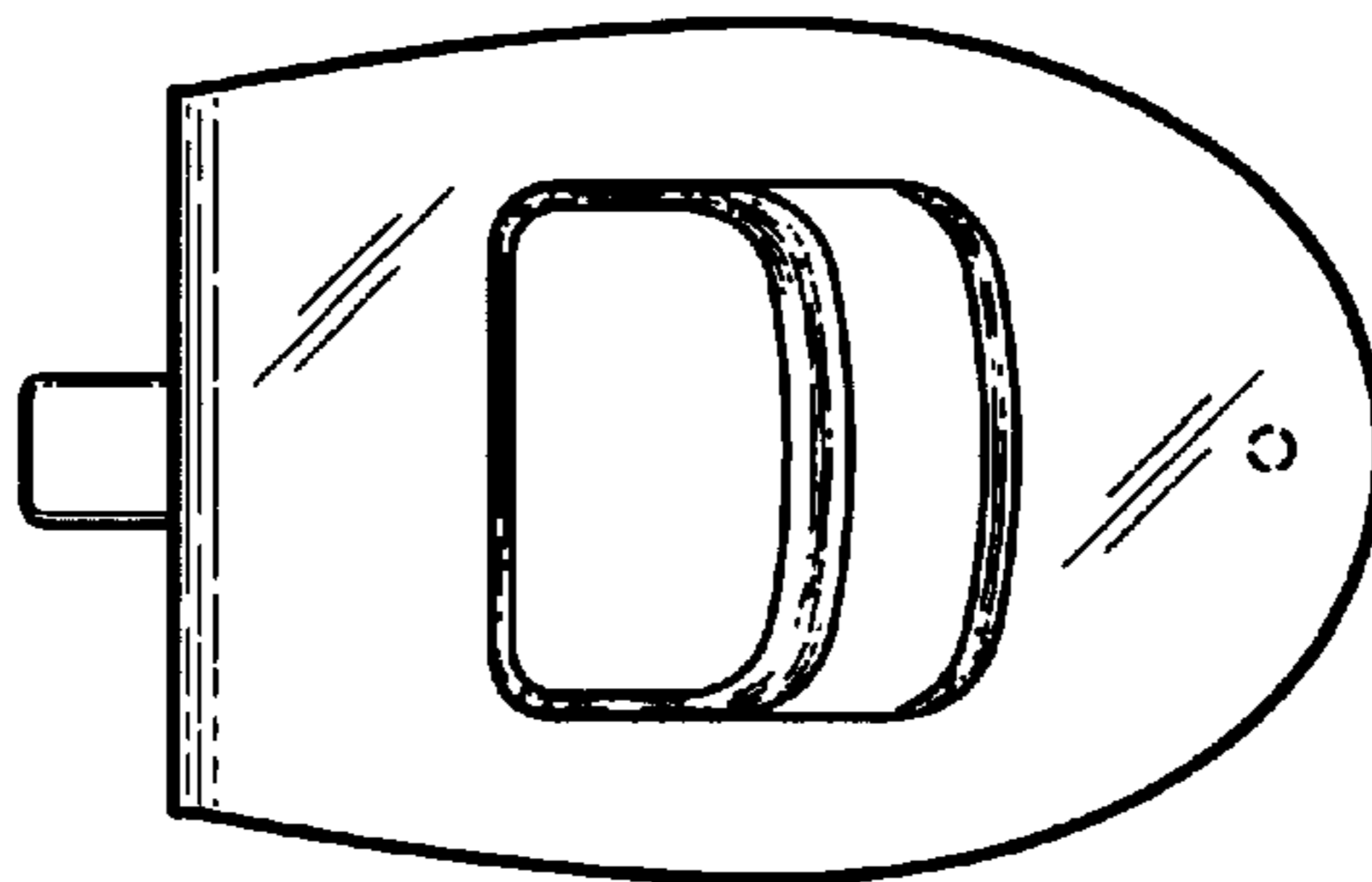

FIG. 5

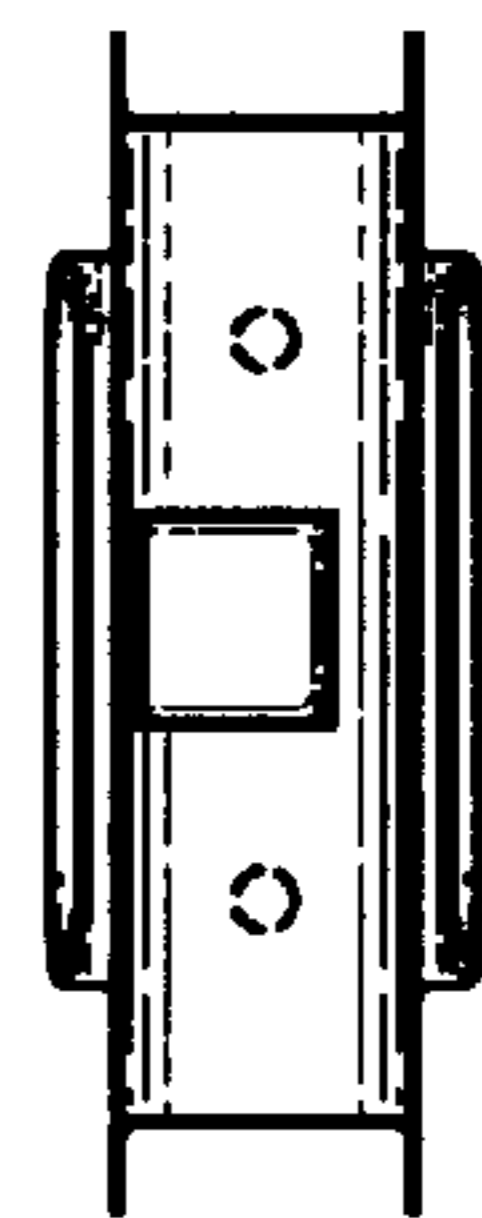

FIG. 6

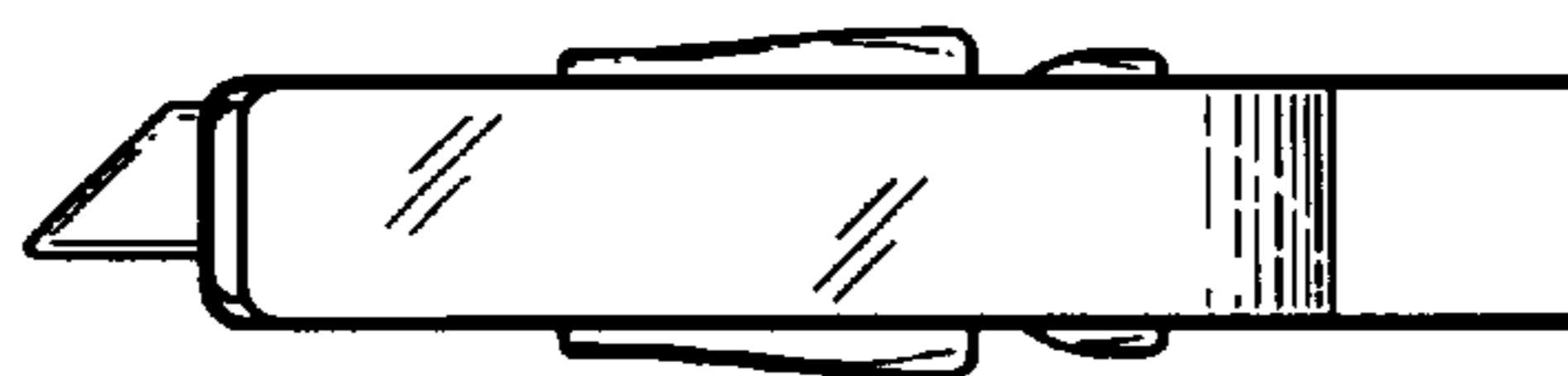

FIG. 7