



US00D440789S

(12) **United States Design Patent**
Tabbia

(10) **Patent No.:** **US D440,789 S**

(45) **Date of Patent:** **** Apr. 24, 2001**

(54) **CHEST OF DRAWERS**

(76) **Inventor:** **Lawrence E. Tabbia**, 102 E. Pleasant Grove Rd., Jackson, NJ (US) 08527

(**) **Term:** **14 Years**

(21) **Appl. No.:** **29/119,980**

(22) **Filed:** **Mar. 14, 2000**

(51) **LOC (7) Cl.** **06-04**

(52) **U.S. Cl.** **D6/446**

(58) **Field of Search** D6/432-448; 312/204, 312/257

(56) **References Cited**

U.S. PATENT DOCUMENTS

D. 337,218	*	7/1993	Black	D6/445 X
D. 376,057	*	12/1996	Brunner et al.	D6/445
D. 376,494	*	12/1996	Brunner et al.	D6/445
D. 383,331	*	9/1997	Bergelin	D6/445
D. 400,029	*	10/1998	Zaidman	D6/446
D. 401,781	*	12/1998	Zaidman	D6/446
D. 405,985	*	2/1999	Zaidman	D6/445
D. 409,853	*	5/1999	Horn	D6/445 X
D. 414,351	*	9/1999	Tabbia	D6/445

* cited by examiner

Primary Examiner—Cathron Brooks

(74) *Attorney, Agent, or Firm*—William J. Daniel

(57) **CLAIM**

The ornamental design for a chest of drawers, as shown and described.

DESCRIPTION

FIG. 1 is a front elevational view of a chest of drawers showing my new design;

FIG. 2 is a right side elevational view of the chest of FIG. 1;

FIG. 3 is a left side elevational view of the chest of FIG. 1;

FIG. 4 is a top plan view of the chest of FIG. 1;

FIG. 5 is an enlarged sectional view taken along line 5—5 of FIG. 1, showing a portion of the claimed design for ease of illustration;

FIG. 6 is a front elevational view of a second embodiment of the chest shown in FIG. 1;

FIG. 7 is a top plan view of the chest shown in FIG. 6;

FIG. 8 is a front elevational view of the third embodiment of the chest shown in FIG. 1; and,

FIG. 9 is a top plan view of the chest shown in FIG. 8.

1 Claim, 5 Drawing Sheets

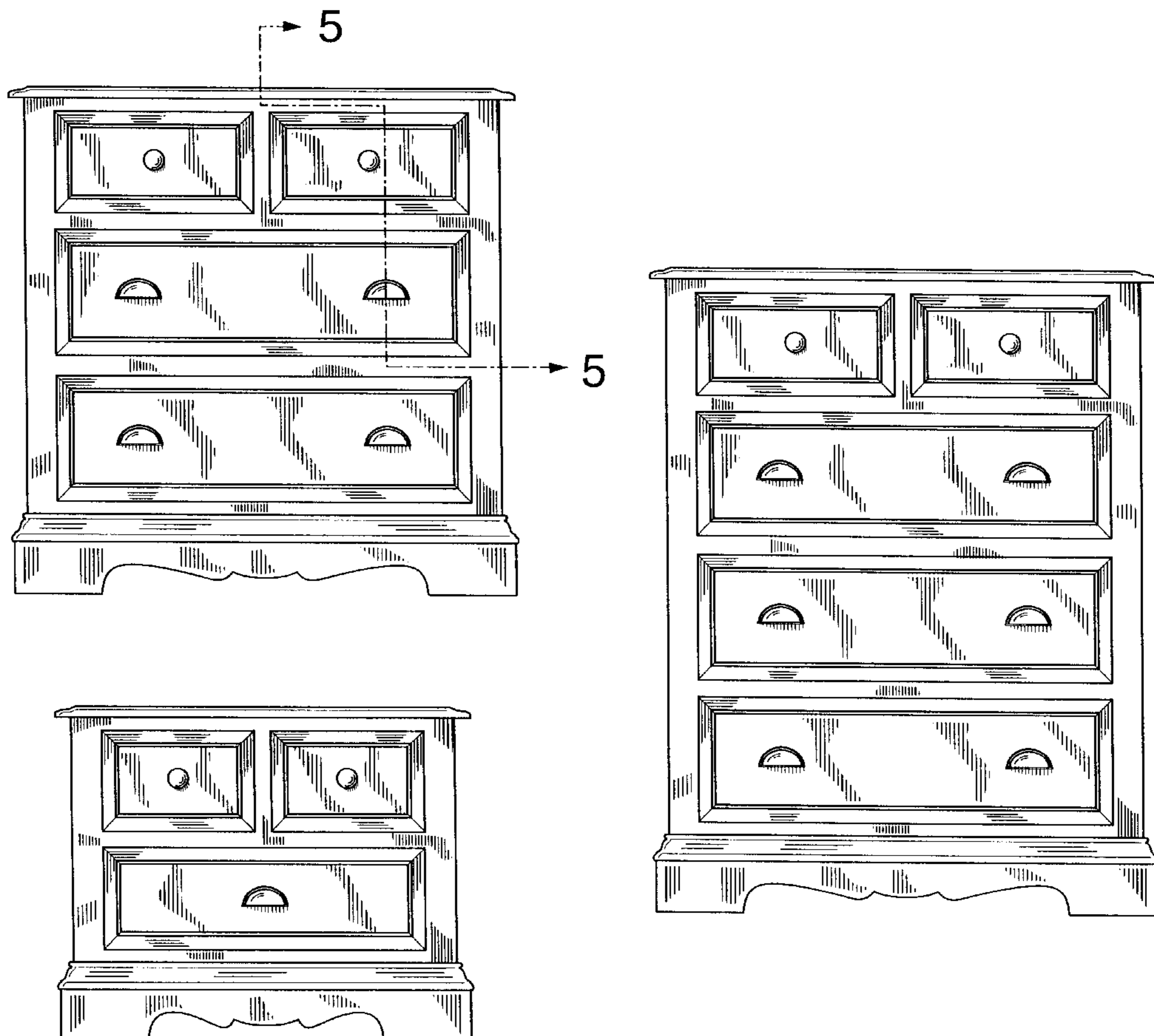

FIG. 1

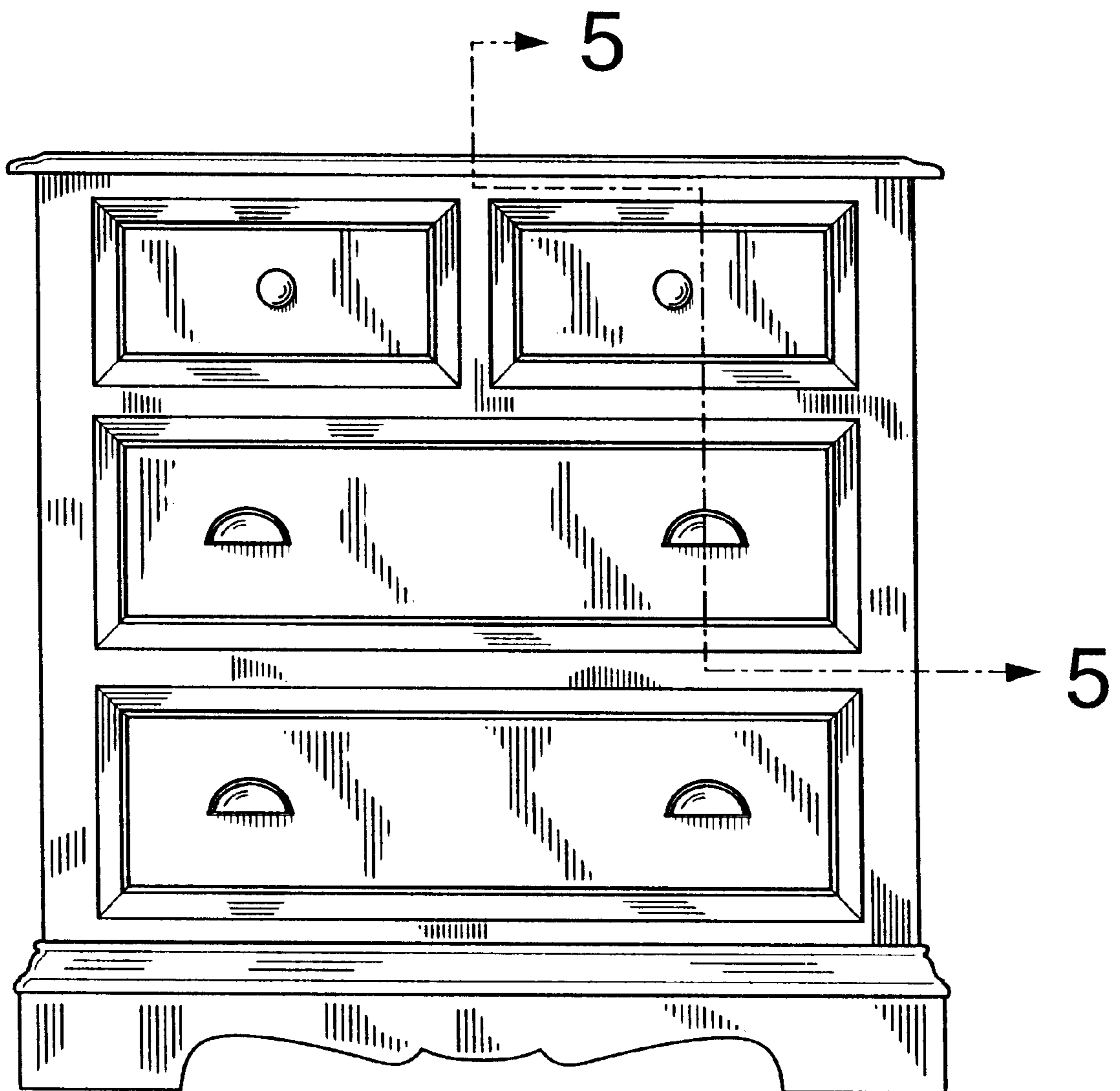

FIG. 2

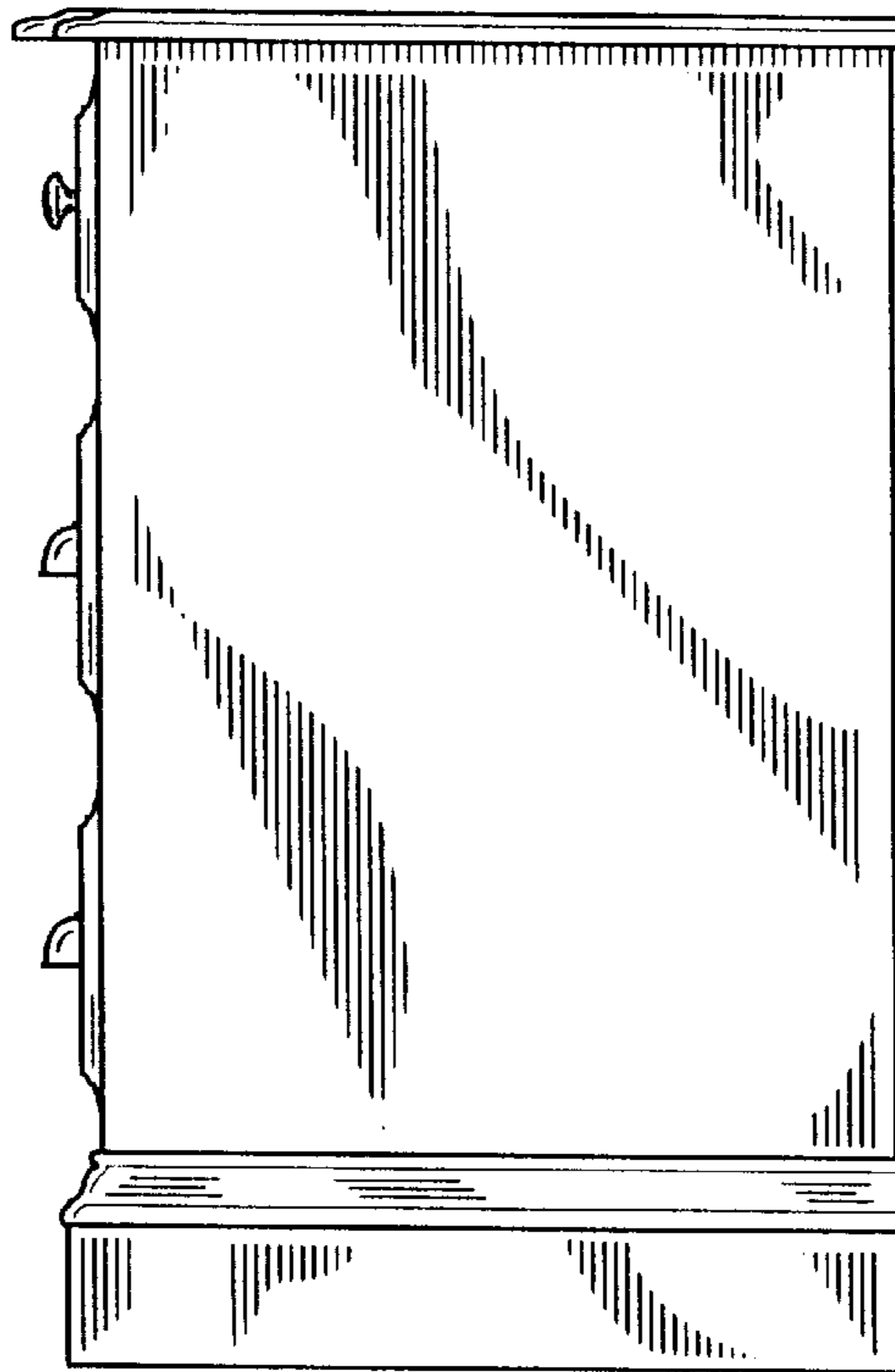

FIG. 3

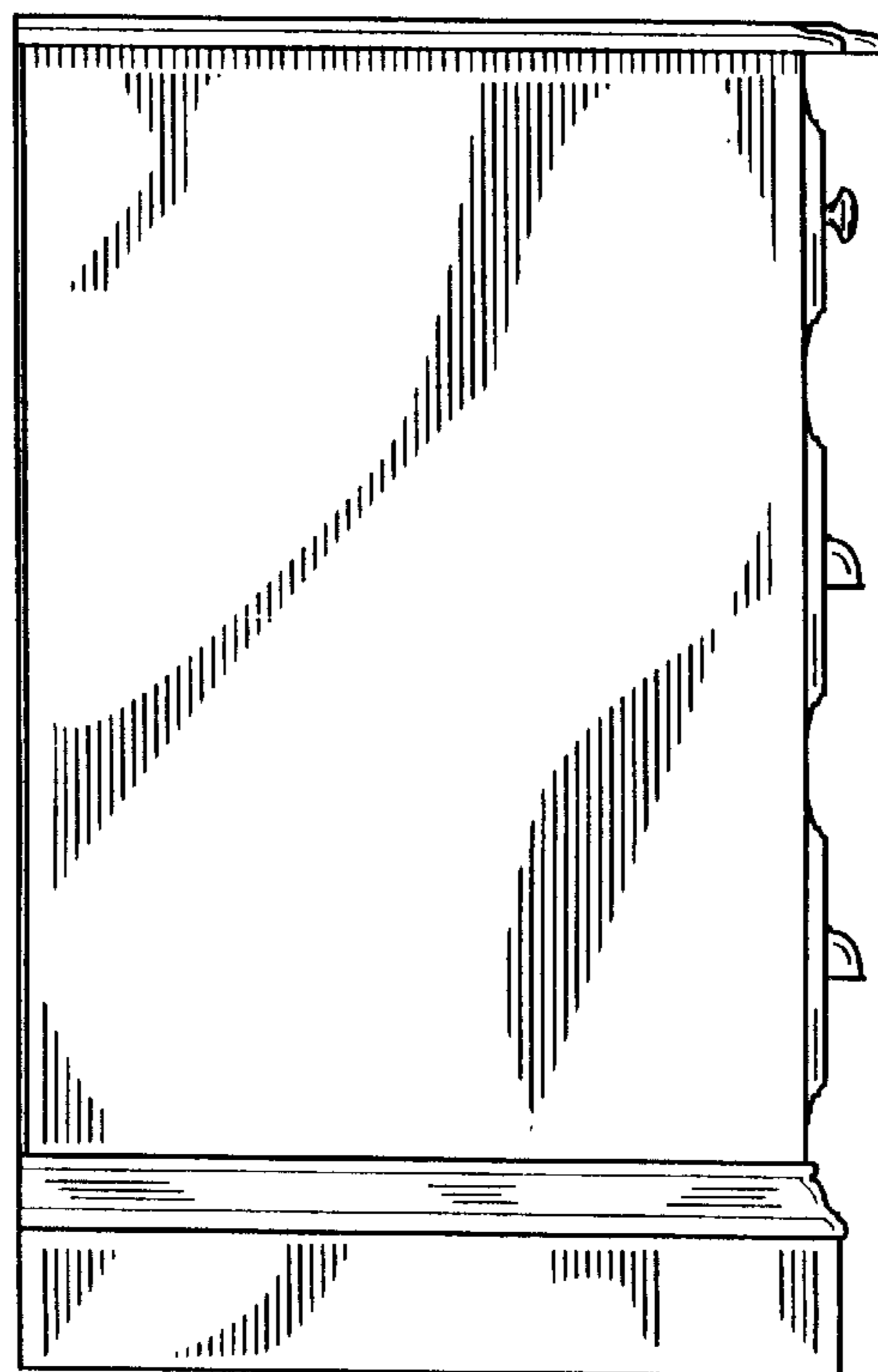

FIG. 4

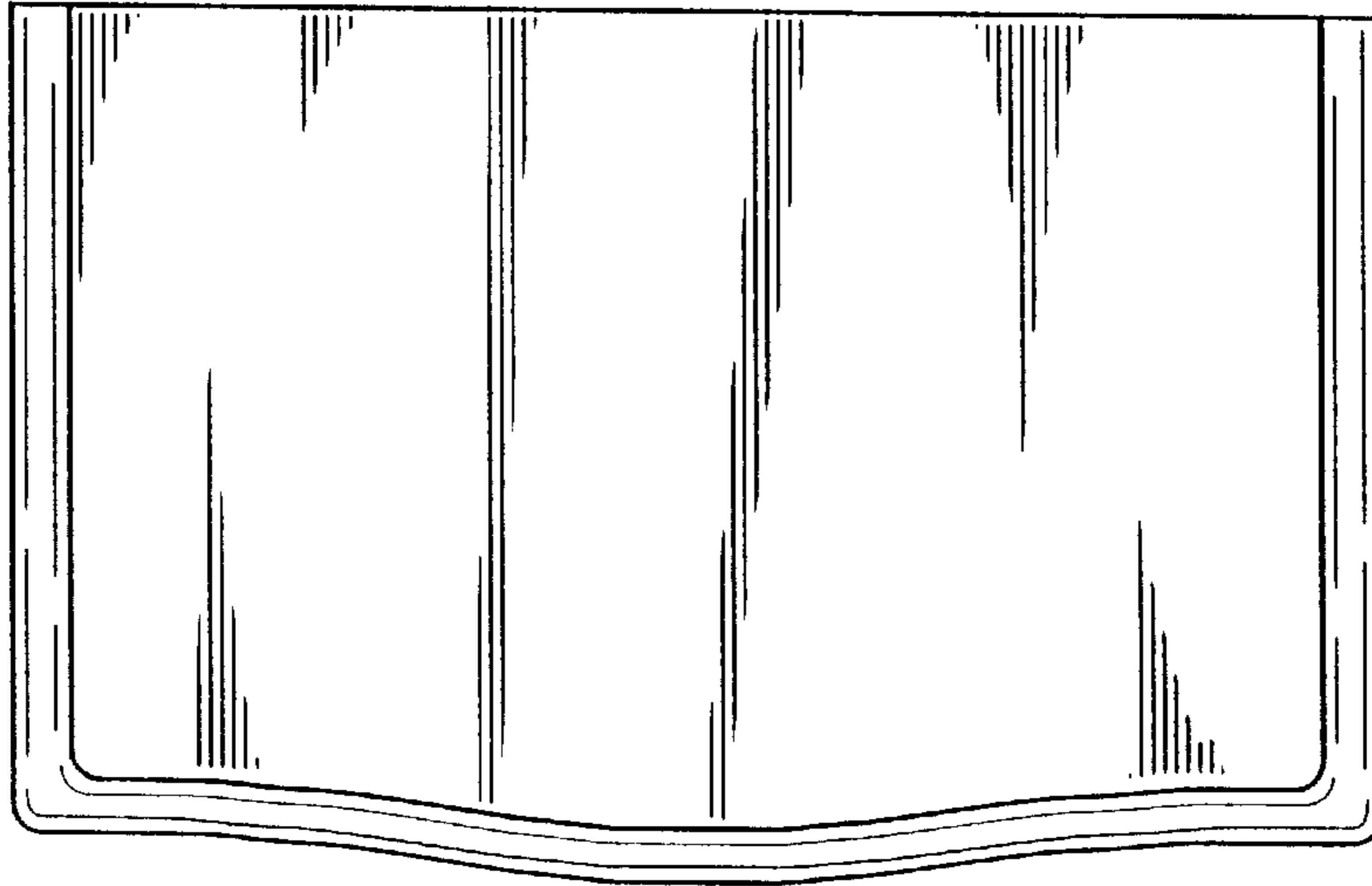

FIG. 5

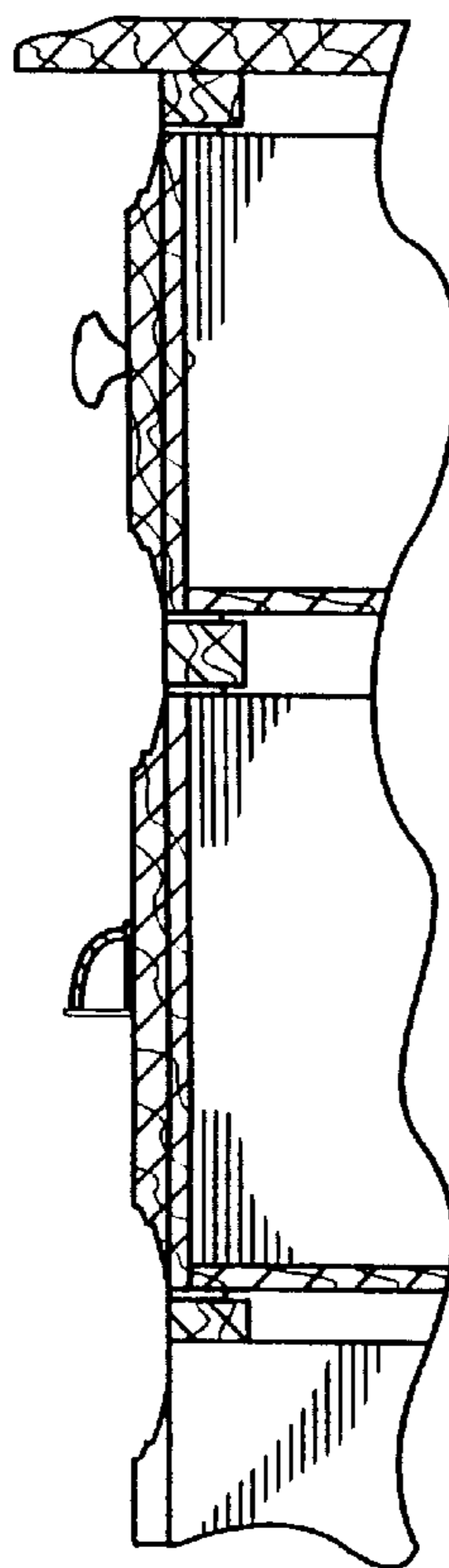

FIG. 6

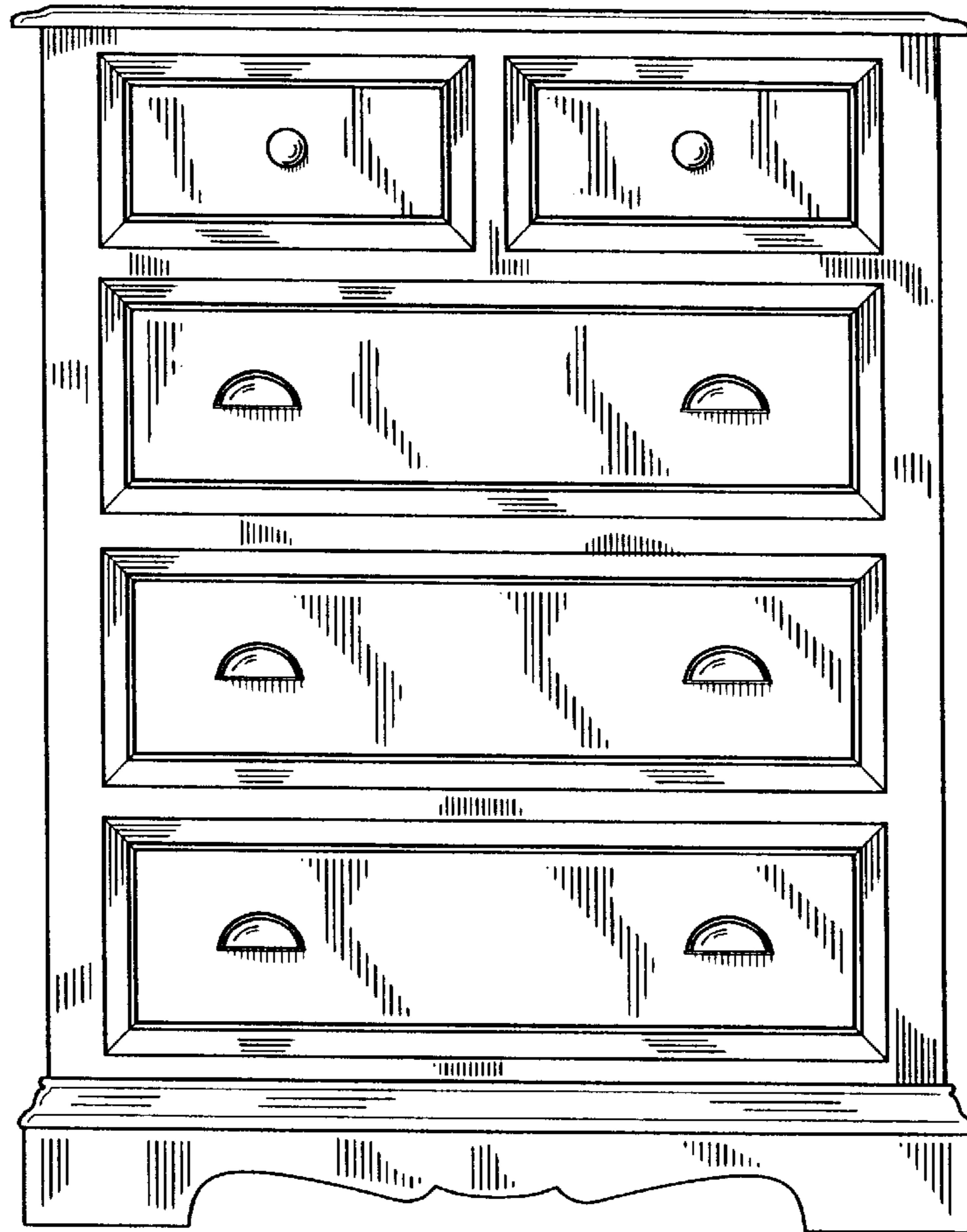

FIG. 7

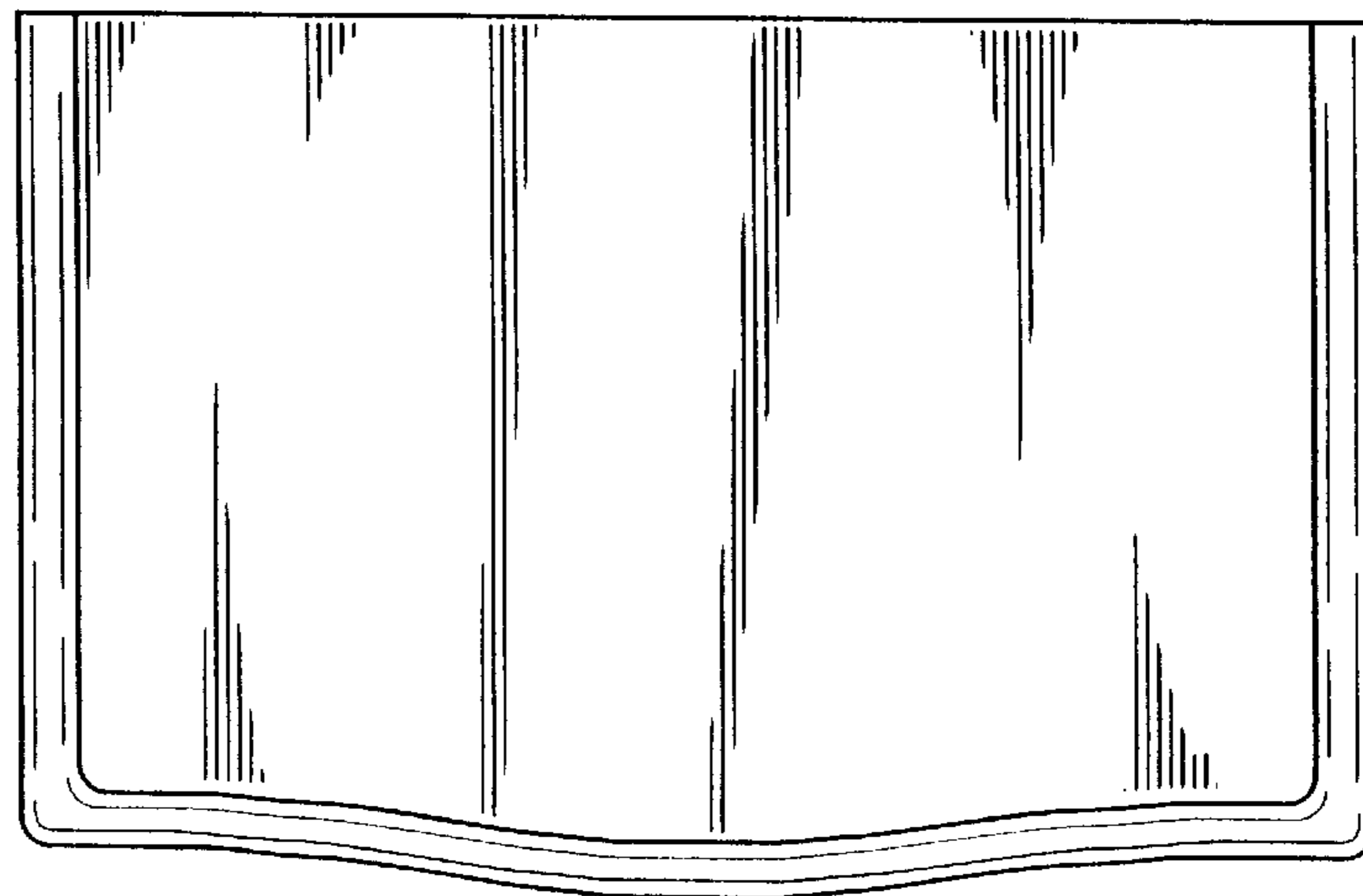

FIG. 8

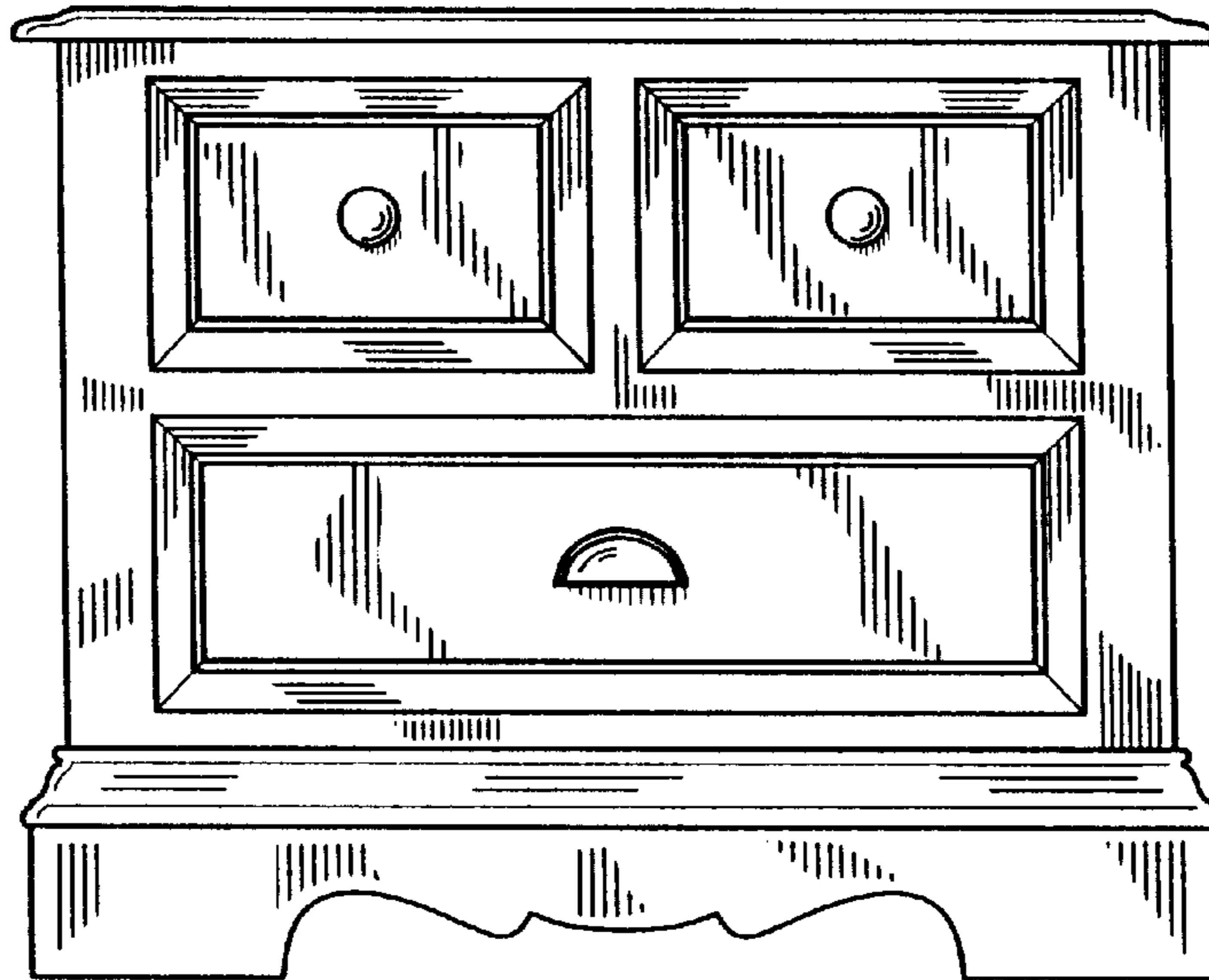

FIG. 9

