



US00D440713S

(12) **United States Design Patent**
de Baschmakoff

(10) **Patent No.:** **US D440,713 S**

(45) **Date of Patent:** **** Apr. 17, 2001**

(54) **COSMETIC CONTAINER**

(75) Inventor: **Thierry de Baschmakoff**, Paris (FR)

(73) Assignee: **Salvatore Ferragamo Italia S.P.A.**,
Florence (IT)

(**) Term: **14 Years**

(21) Appl. No.: **29/115,572**

(22) Filed: **Dec. 16, 1999**

(30) **Foreign Application Priority Data**

Sep. 23, 1999 (IT) FI9900066

(51) **LOC (7) Cl.** **28-03**

(52) **U.S. Cl.** **D28/76; D28/91.1**

(58) **Field of Search** D28/91.1, 73,
D28/74, 76, 61; D9/300, 502, 504, 520,
528, 529; D19/35, 77; D4/114; D3/205;
239/304, 327, 362; 401/149, 175

(56) **References Cited**

U.S. PATENT DOCUMENTS

| | | | | | |
|------------|---|---------|---------------|-------|----------|
| D. 31,892 | * | 11/1899 | Downey | | D28/91.1 |
| D. 326,611 | * | 6/1992 | Dinand | | D9/529 |
| D. 348,333 | * | 6/1994 | Perrin et al. | | D28/91.1 |
| D. 353,993 | * | 1/1995 | Weiss et al. | | D9/300 |
| D. 383,972 | * | 9/1997 | Weiss | | D9/300 |
| D. 392,558 | * | 3/1998 | Monaghan | | D9/300 |
| D. 422,899 | * | 4/2000 | Kudo | | D9/300 |
| D. 424,946 | * | 5/2000 | Alsup | | D9/528 |

* cited by examiner

Primary Examiner—Paula A. Mortimer

(74) *Attorney, Agent, or Firm*—Ladas & Parry

(57) **CLAIM**

I claim the ornamental design for cosmetic container, as shown and described.

DESCRIPTION

FIG. 1 is perspective view of a cosmetic container showing my new design;

FIG. 2 is a first side view of the container of FIG. 1;

FIG. 3 is a second side view of the container of FIG. 1;

FIGS. 4 and 5 are side views taken from opposite sides with respect to FIGS. 2 and 3 respectively;

FIG. 6 is a top plan view of the container of FIG. 1;

FIG. 7 is a bottom plan view of the container of FIG. 1.

FIG. 8 is a perspective view of a second embodiment of the cosmetic container of FIG. 1 in which a portion is transparent;

FIG. 9 is a first side view of the container of FIG. 8;

FIG. 10 is a second side view of the container of FIG. 8;

FIGS. 11 and 12 are side views taken from opposite sides of the respective FIGS. 9 and 10, respectively;

FIG. 13 is a top plan view of the container of FIG. 8; and,

FIG. 14 is a bottom plan view of the container of FIG. 8.

Broken line disclosure in FIGS. 8–14 is for illustrative purposes only and forms no part of the claimed design.

1 Claim, 6 Drawing Sheets

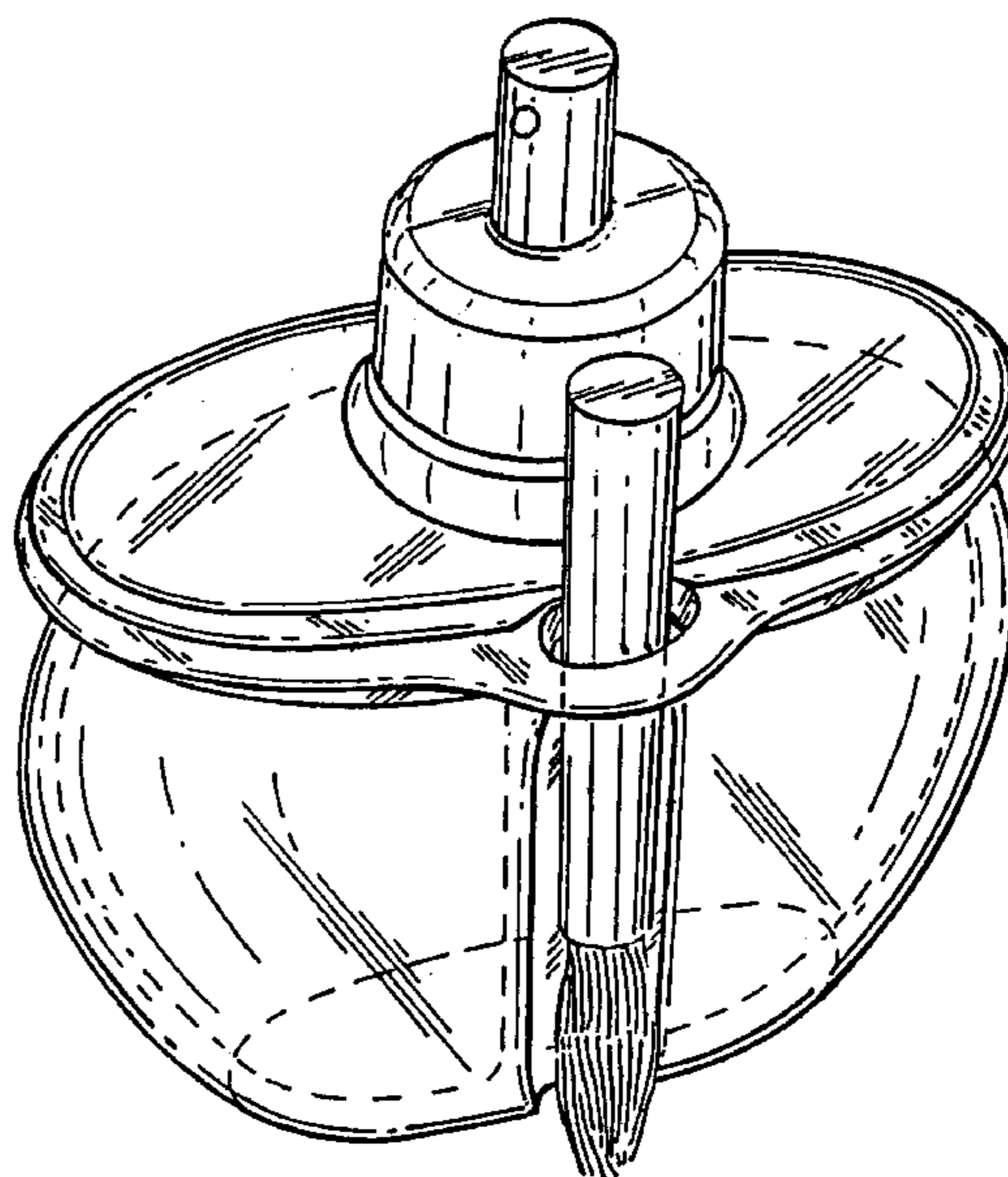
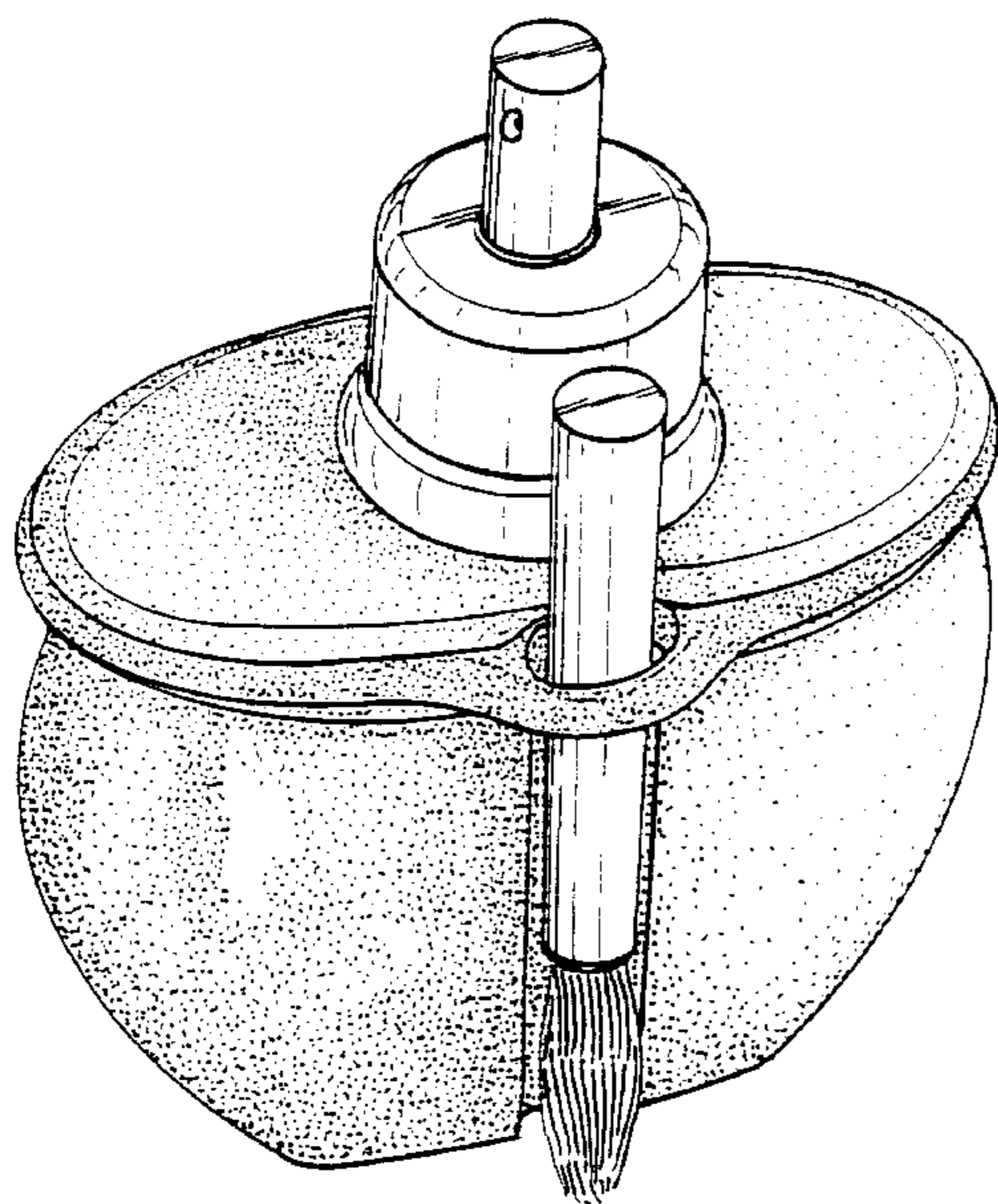

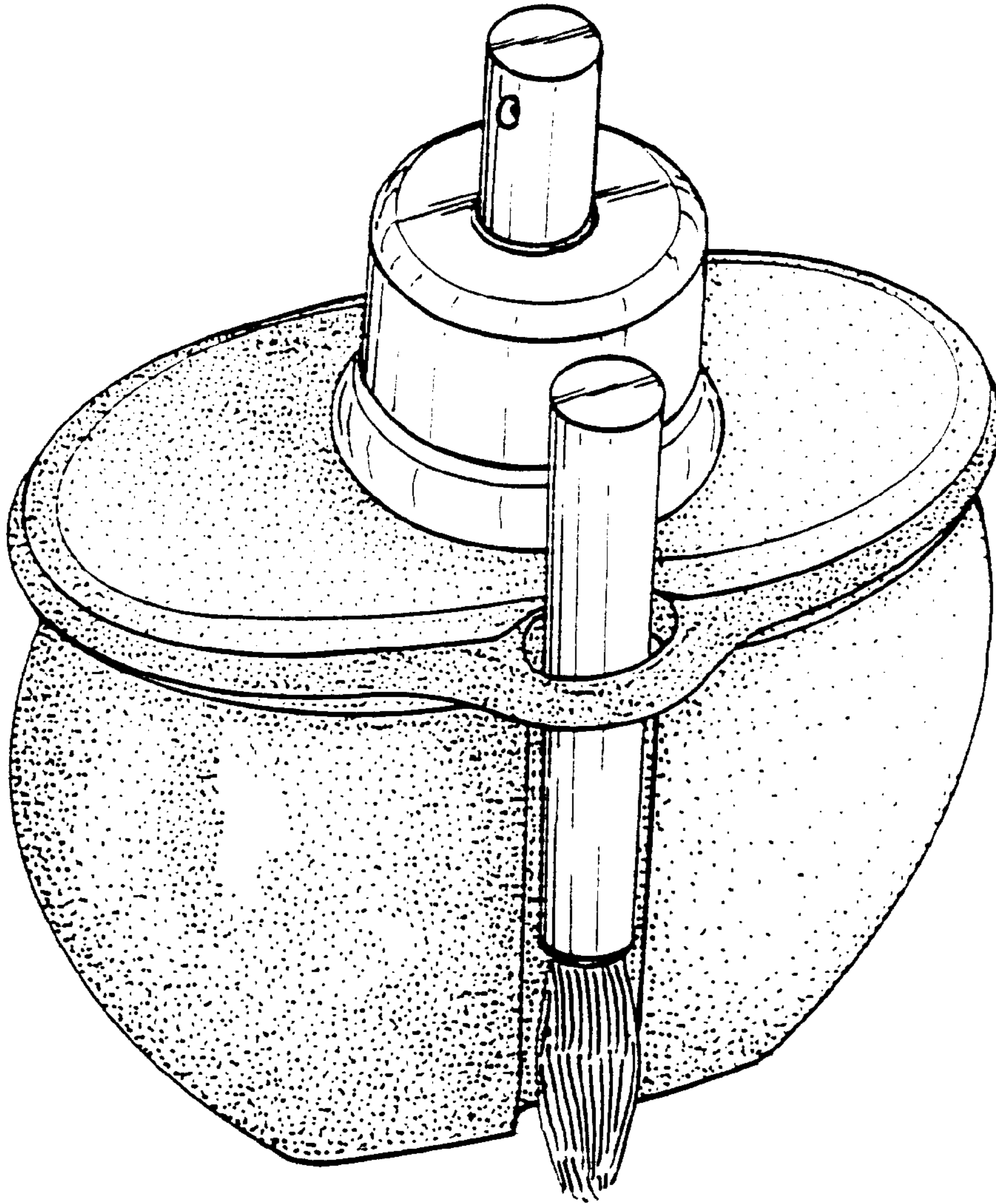

Fig. 1

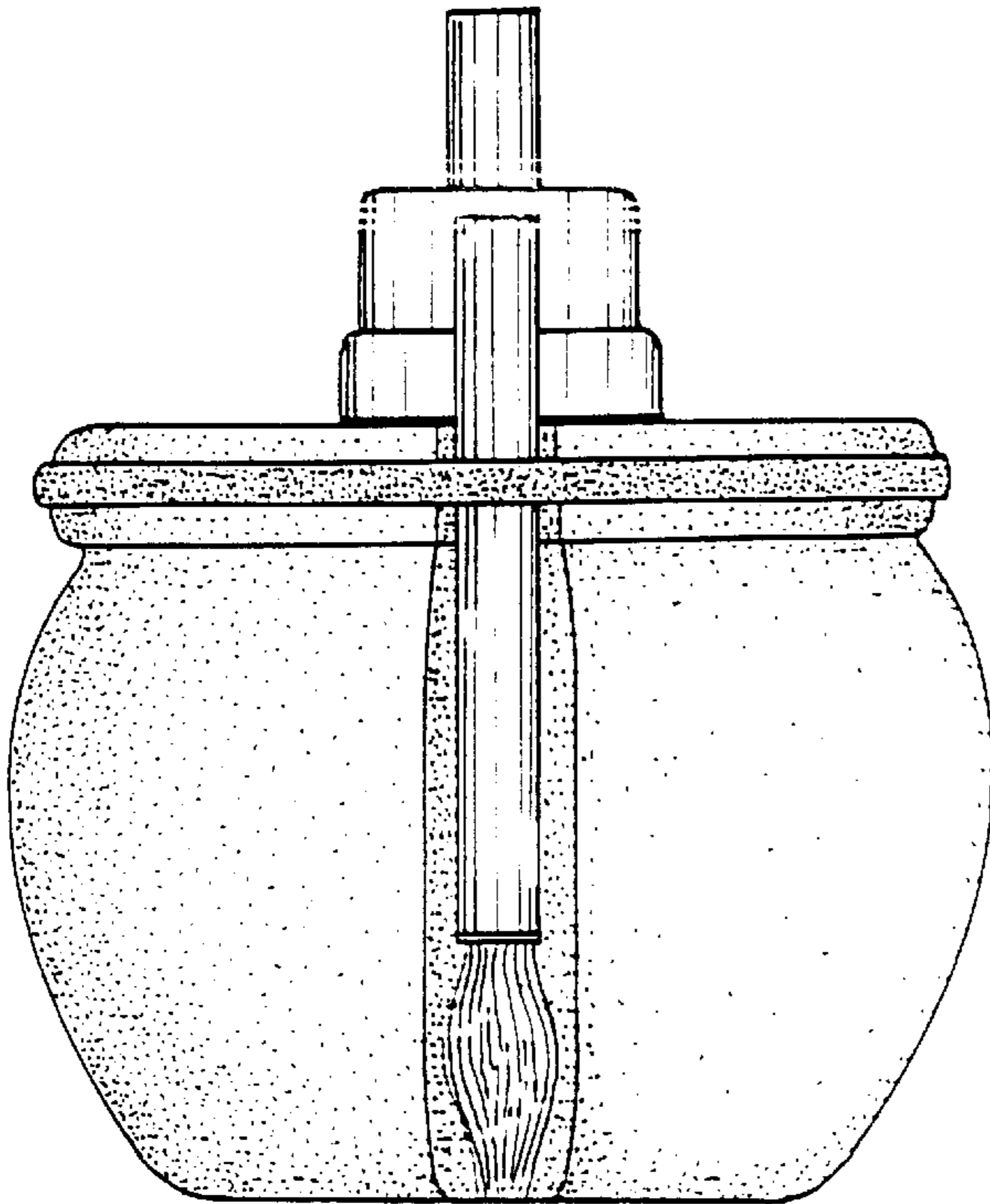

Fig. 2

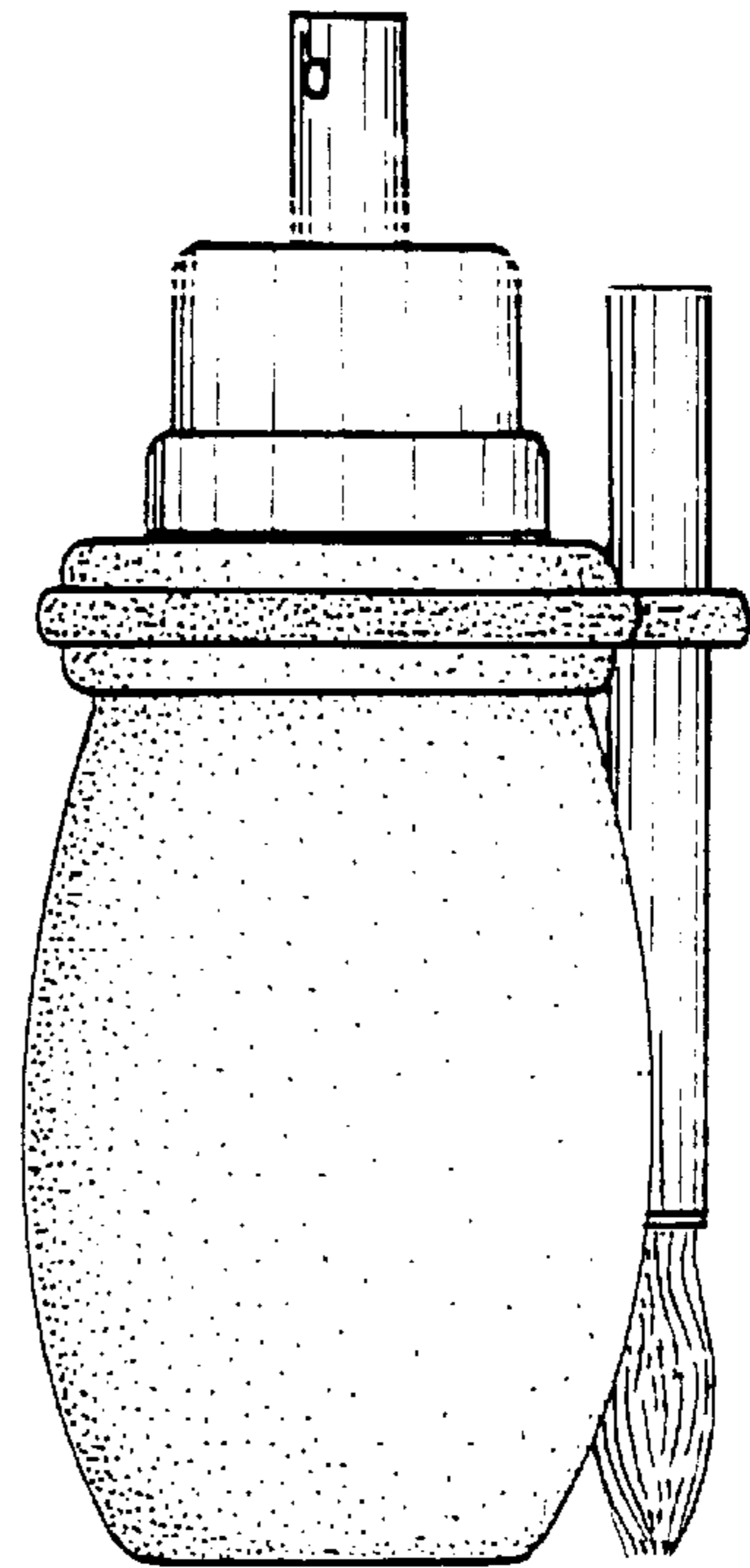

Fig. 3

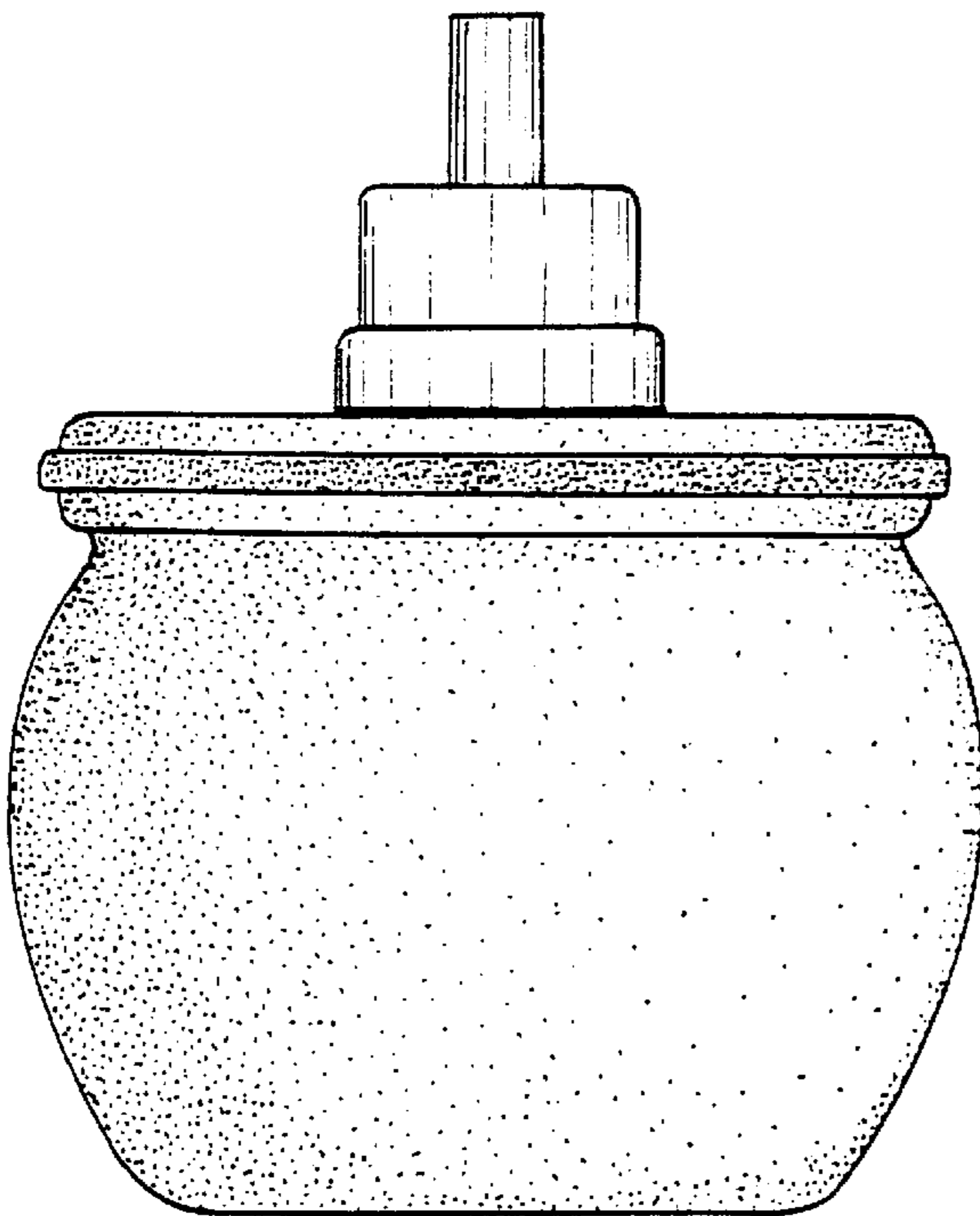

Fig. 4

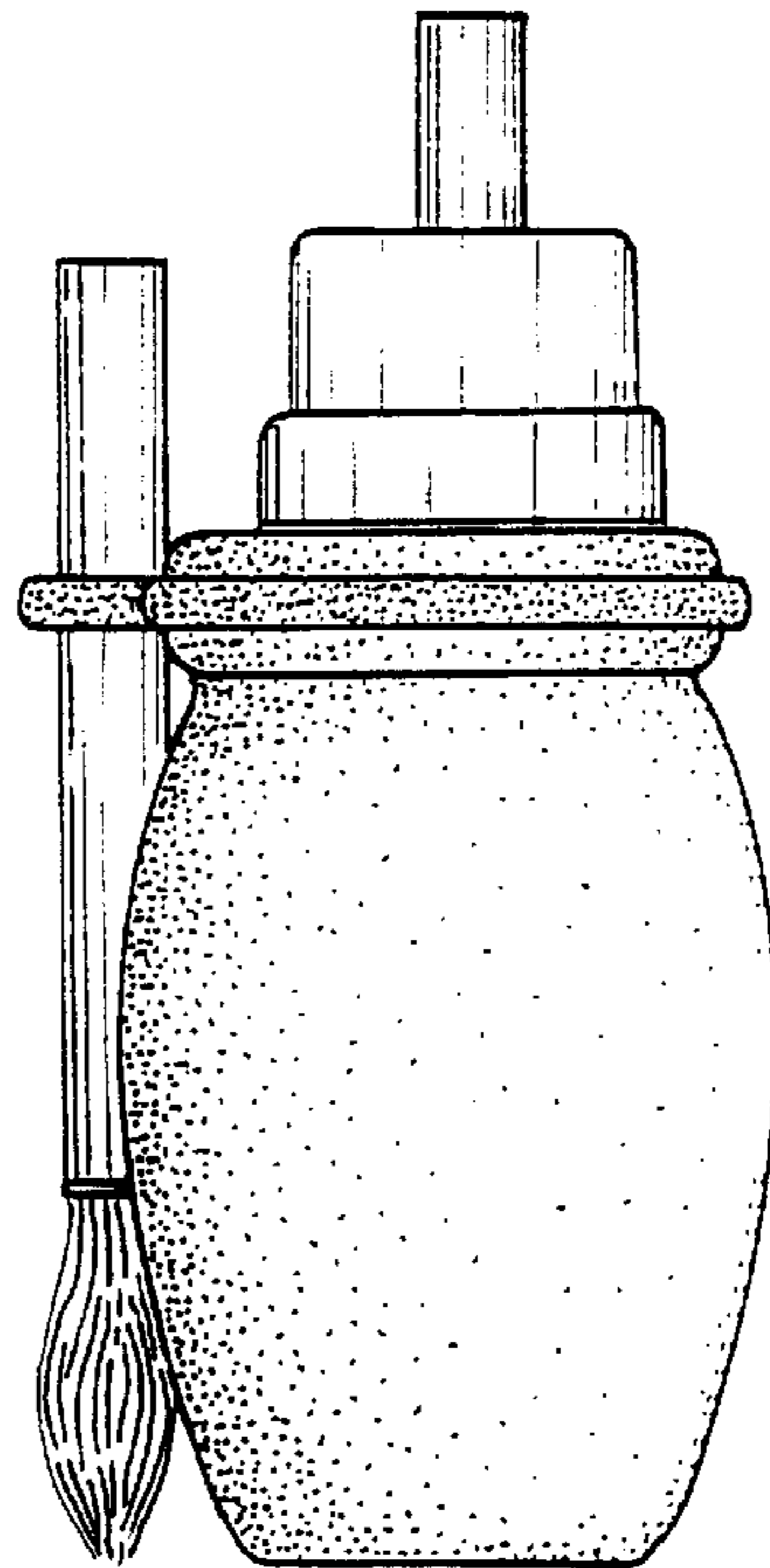

Fig. 5

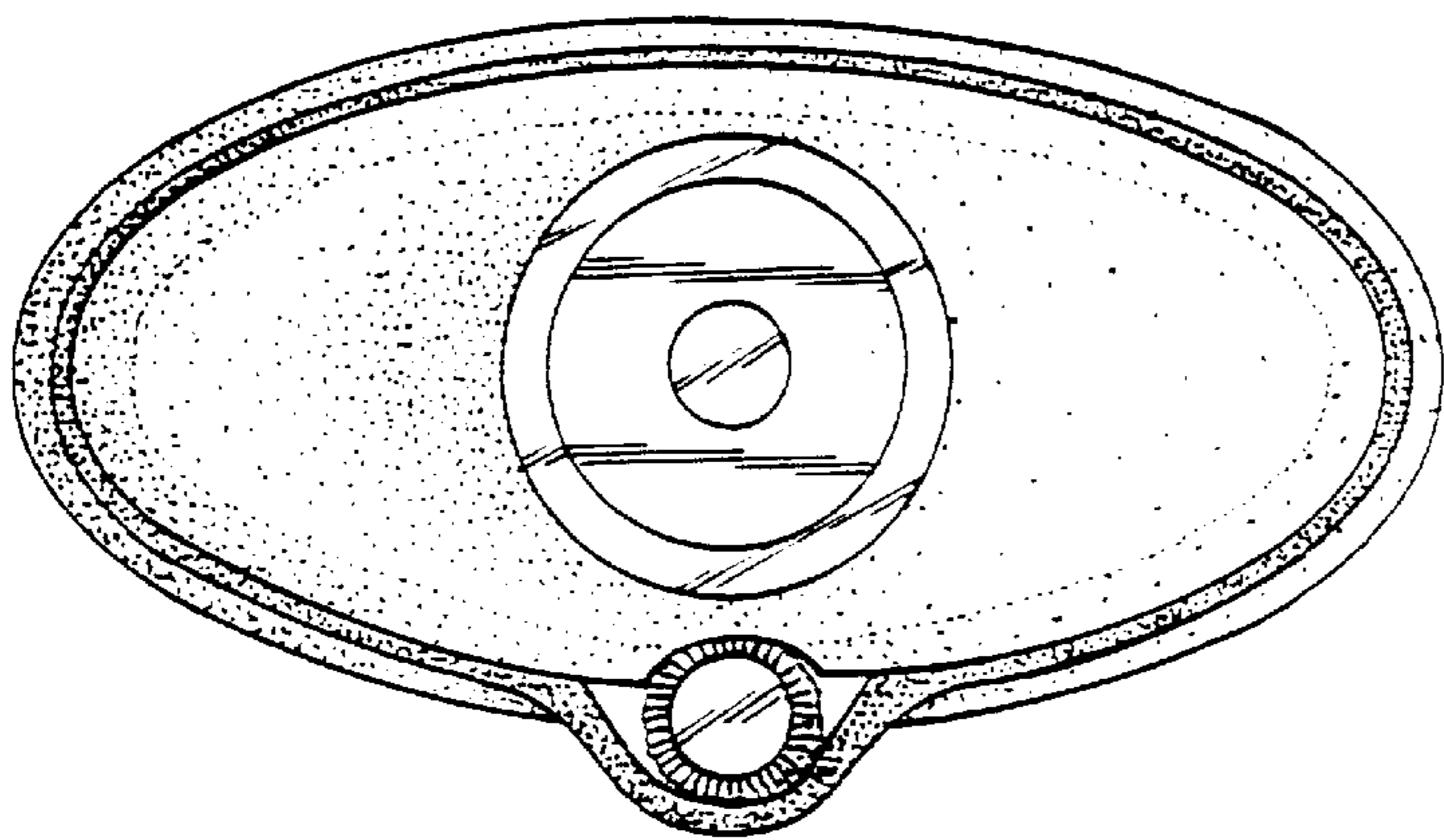

Fig. 6

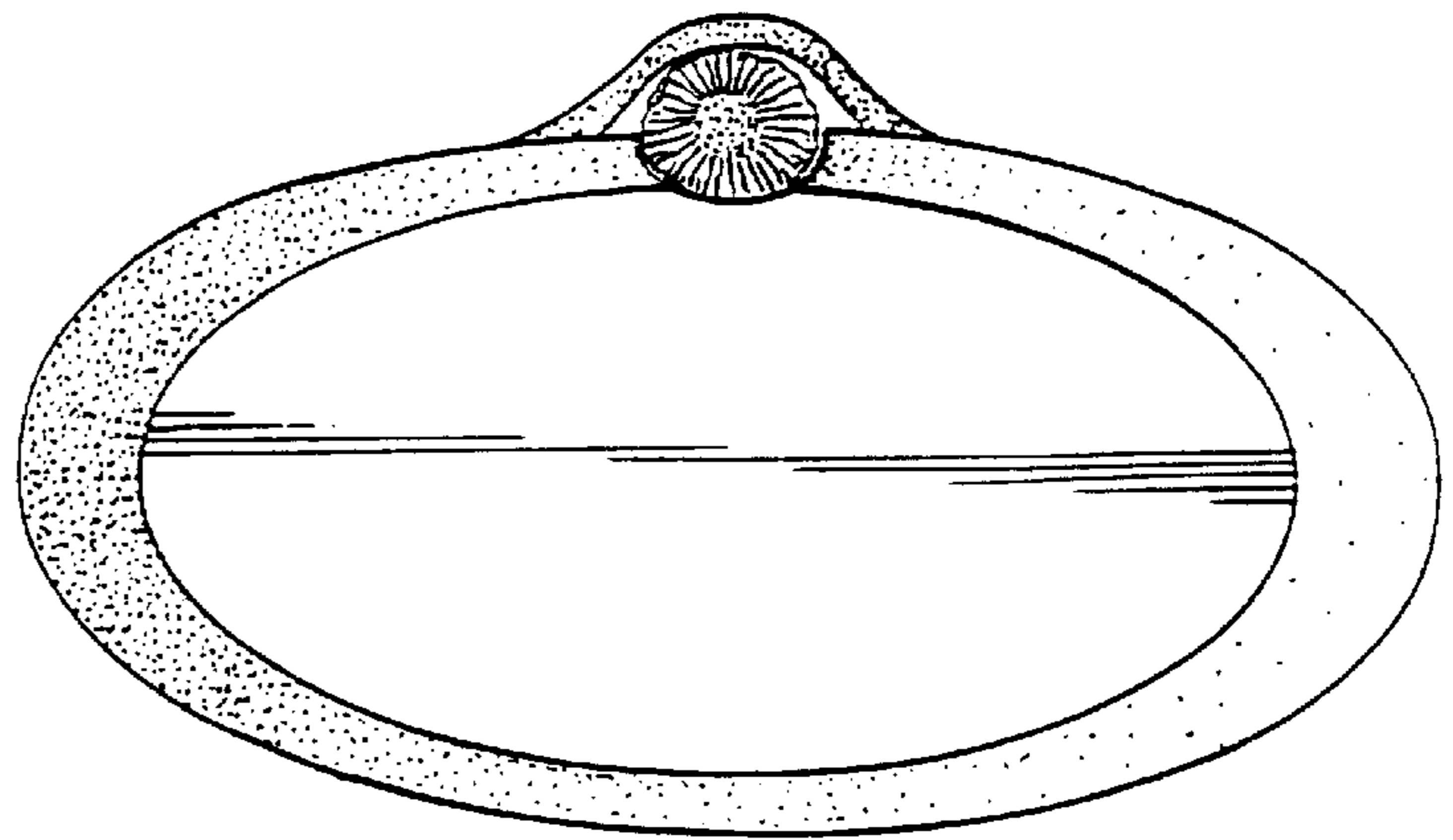

Fig. 7

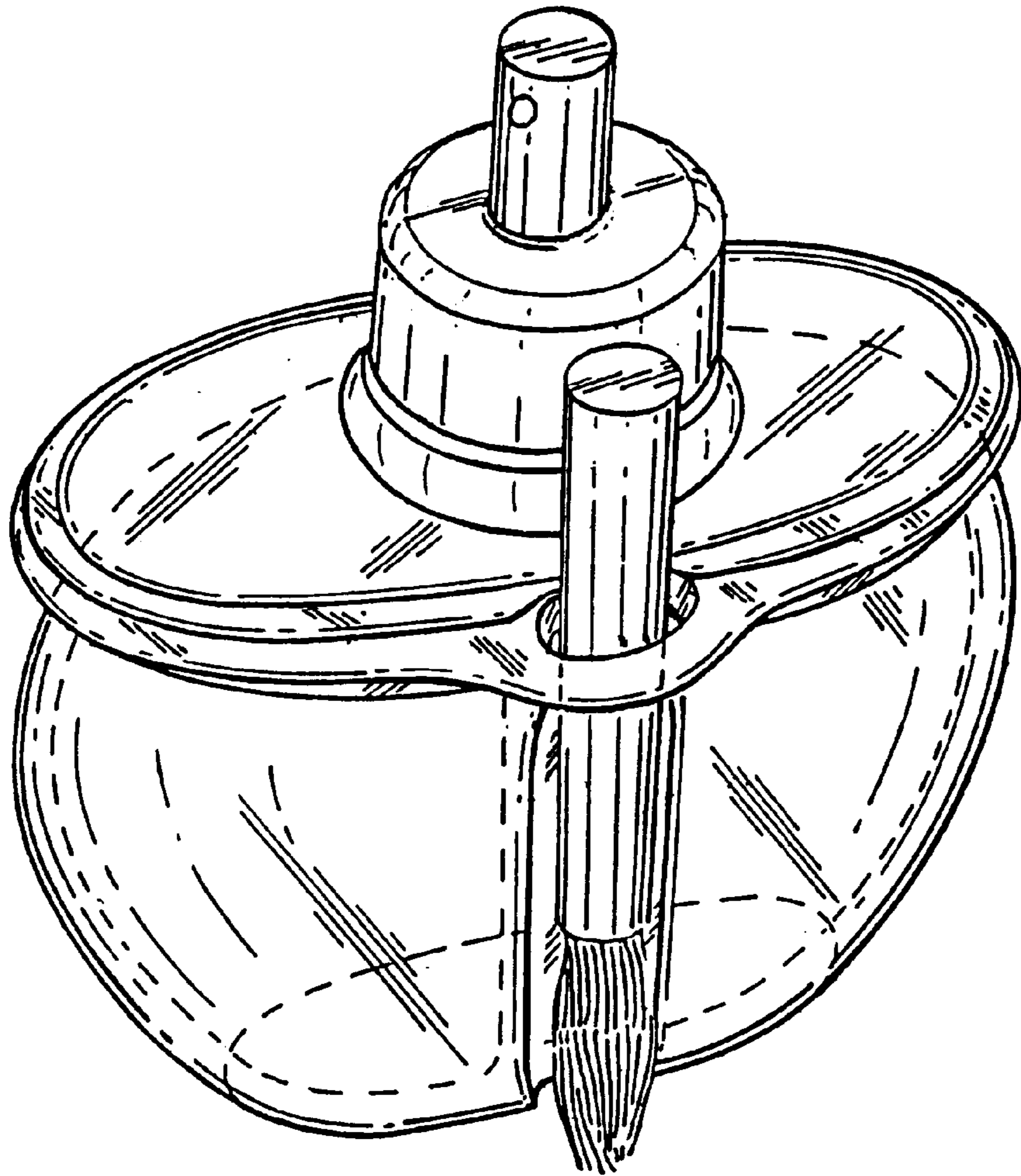

FIG. 8

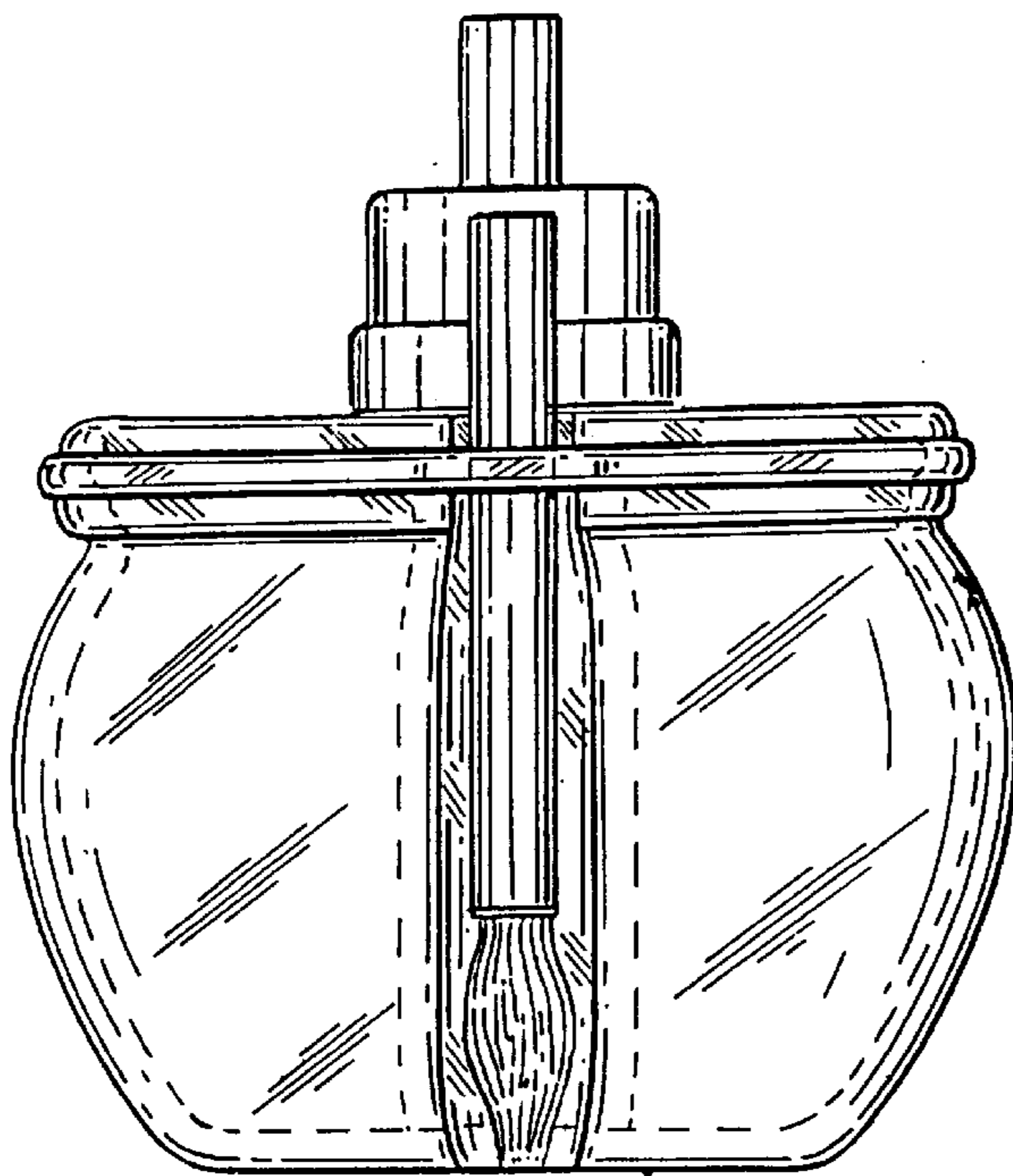

FIG. 9

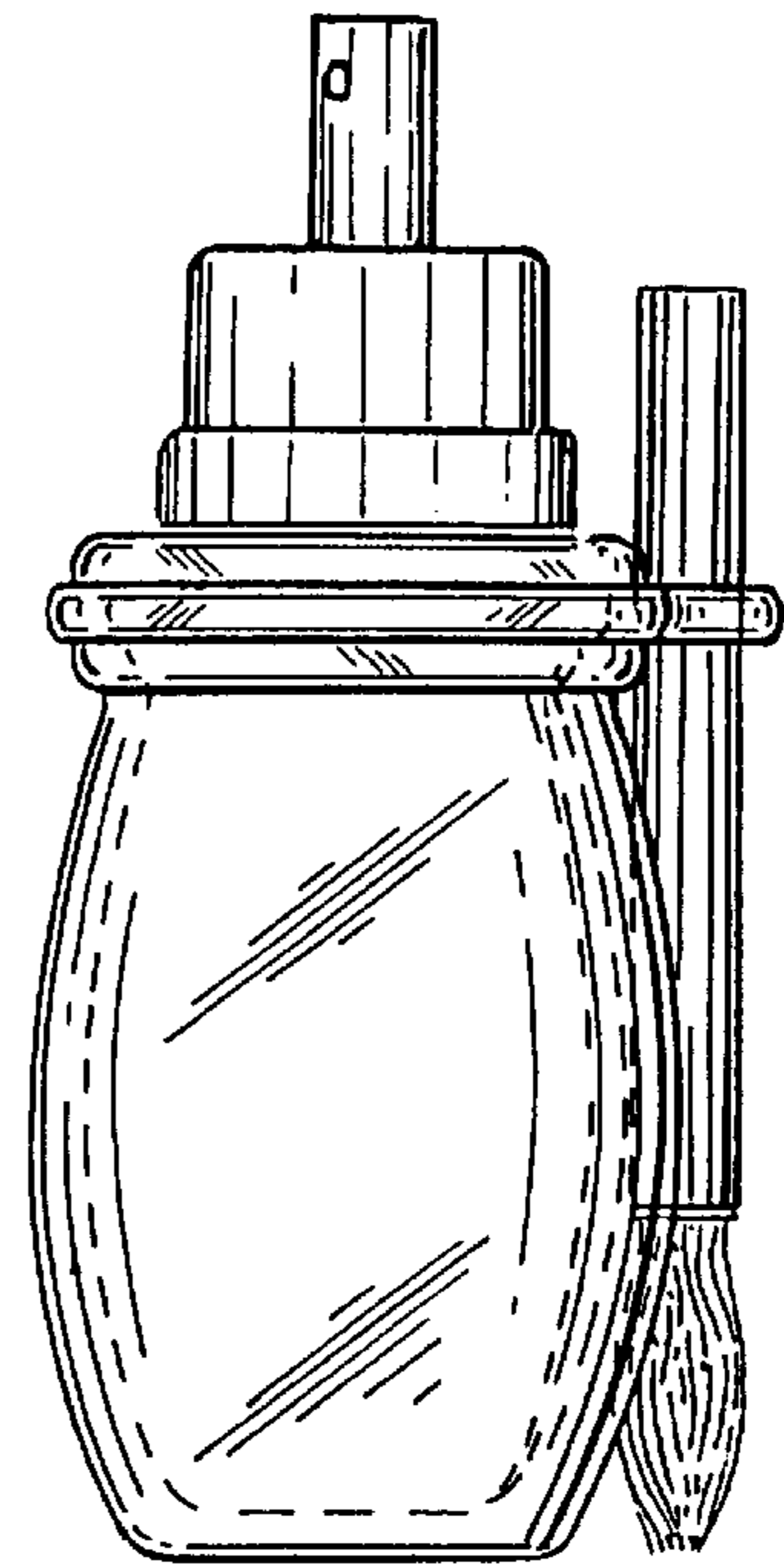

FIG. 10

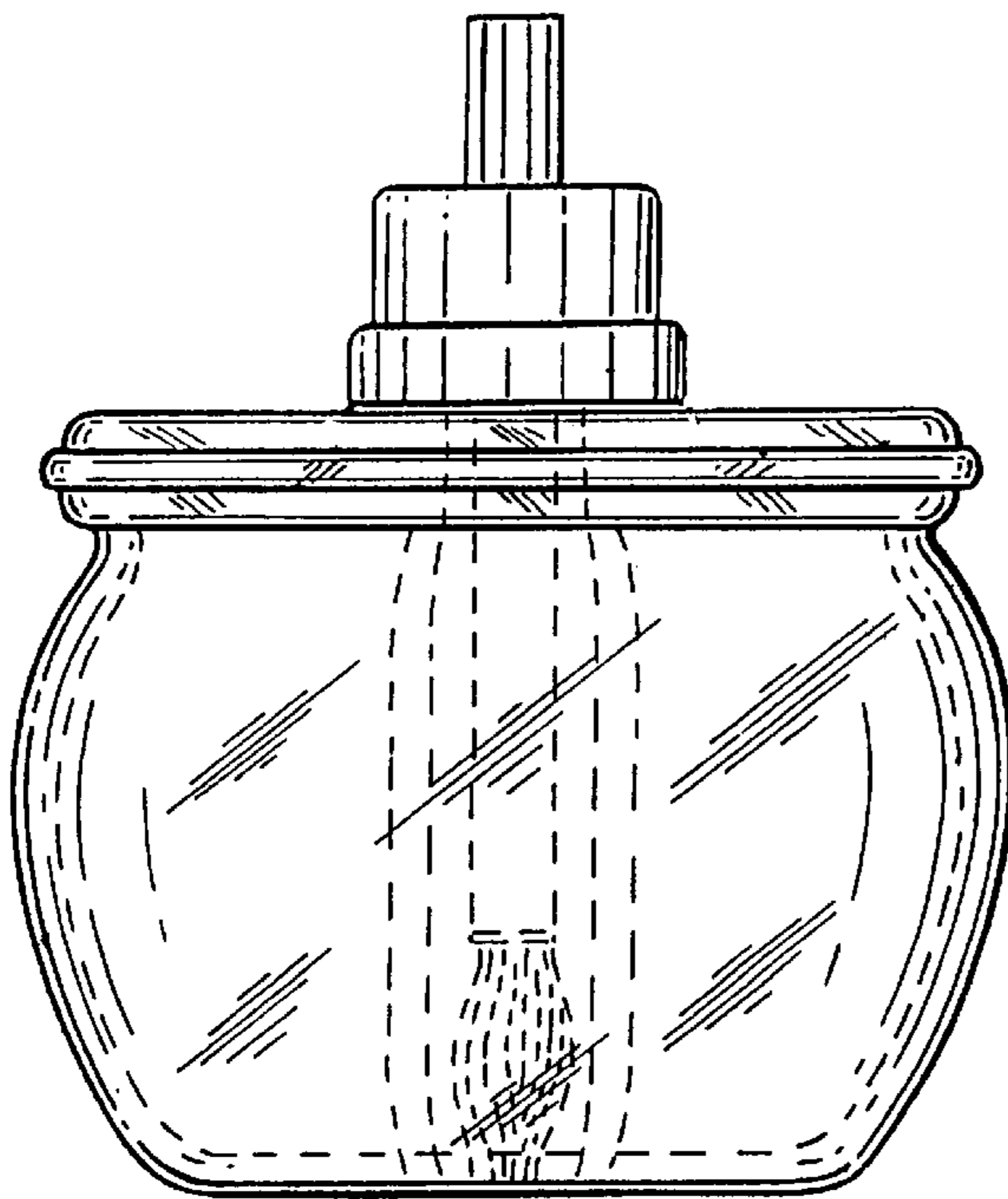

FIG. 11

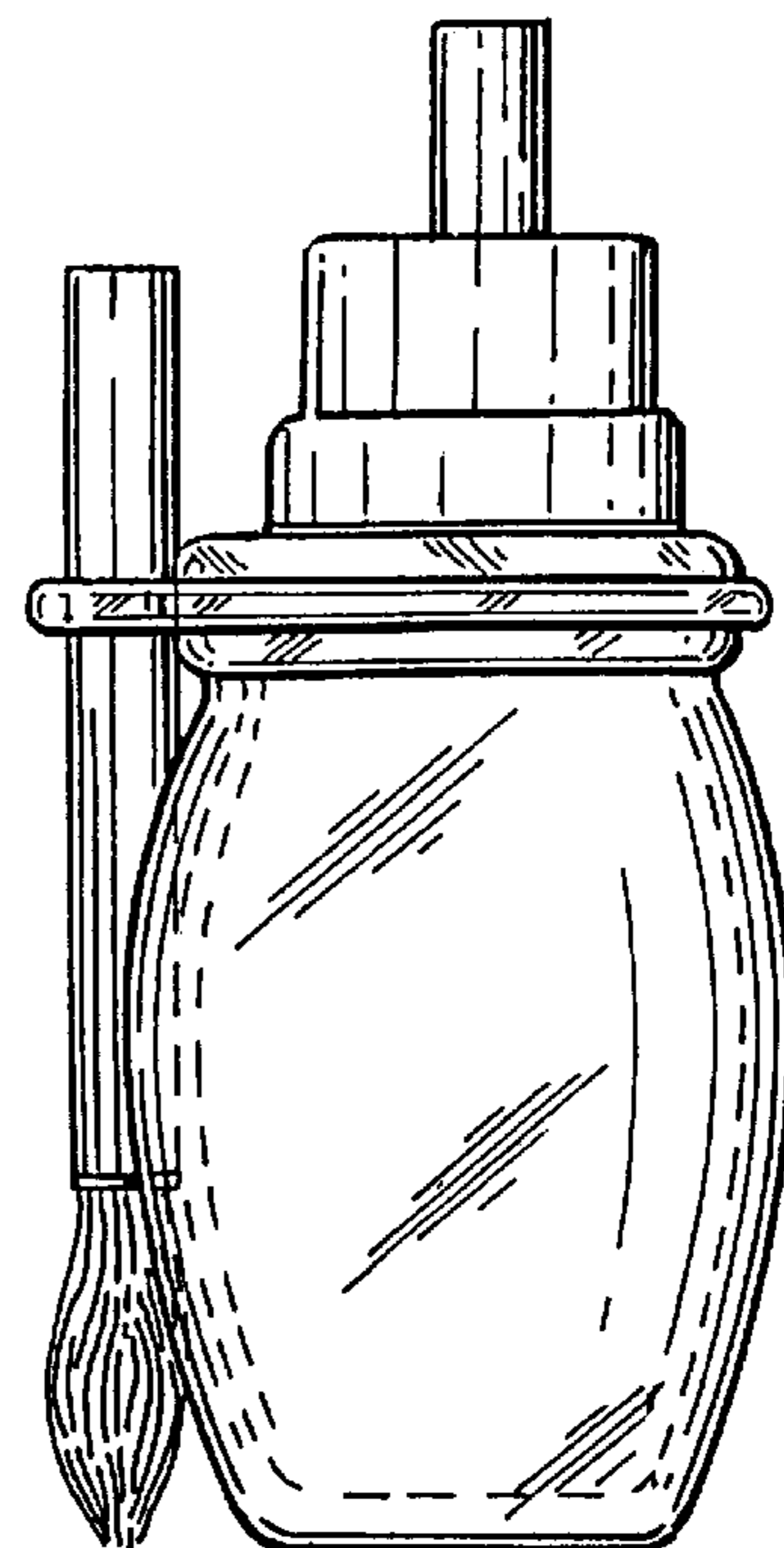

FIG. 12

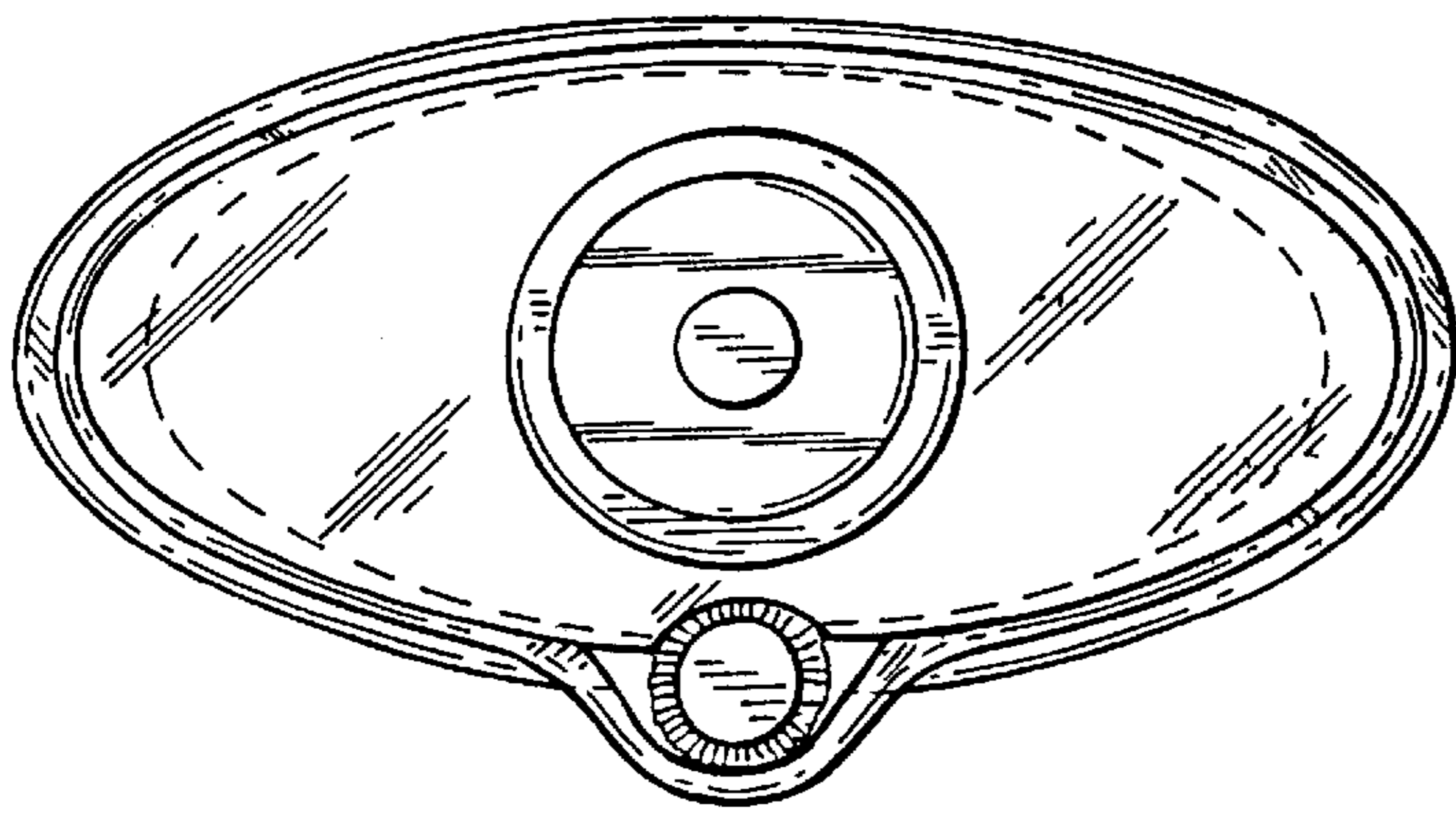

FIG. 13

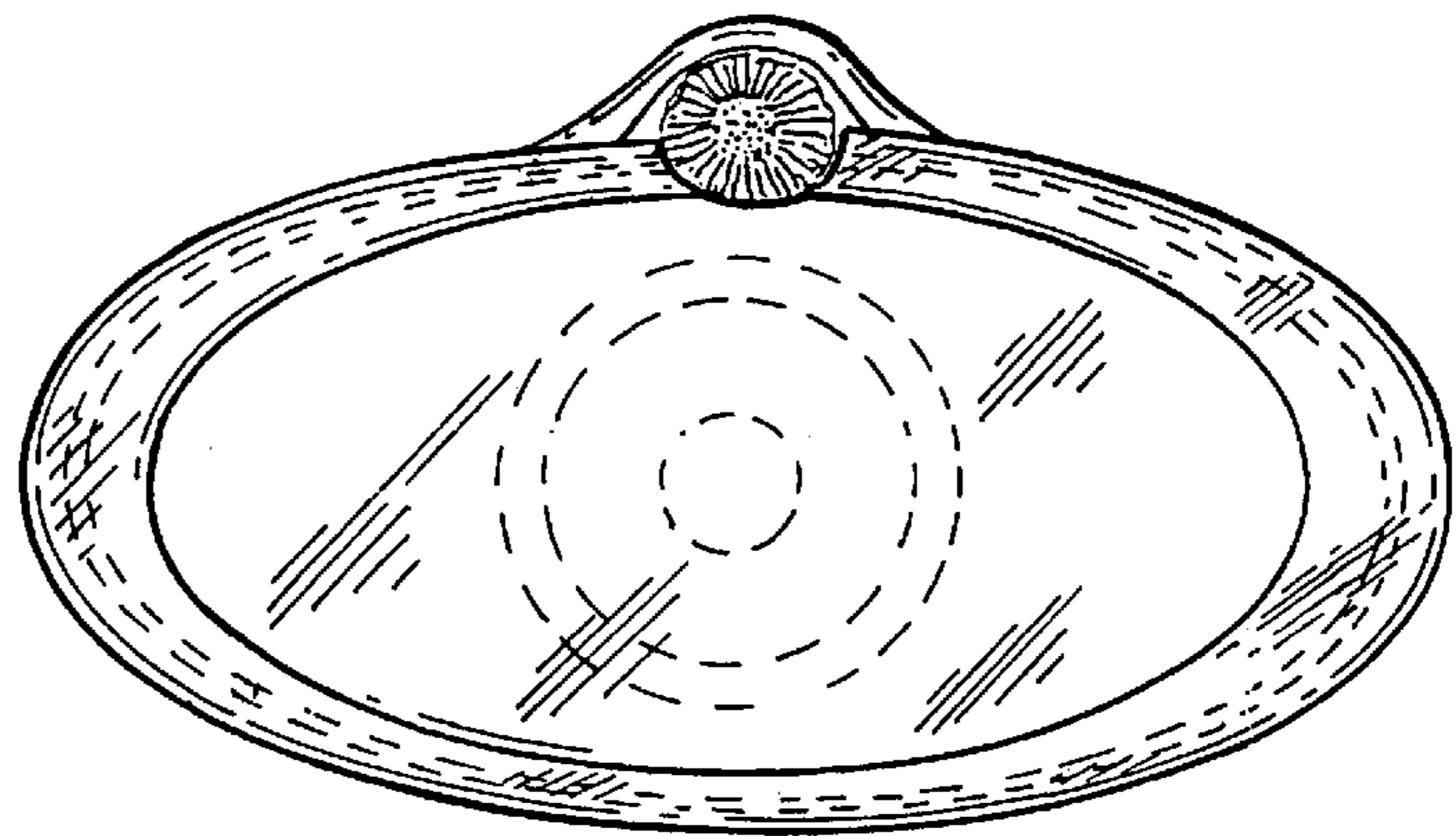

FIG. 14

UNITED STATES PATENT AND TRADEMARK OFFICE
CERTIFICATE OF CORRECTION

PATENT NO. : Des 440,713 S
DATED : April 17, 2001
INVENTOR(S) : Thierry De Baschmakoff

Page 1 of 1

It is certified that error appears in the above-identified patent and that said Letters Patent is hereby corrected as shown below:

Title page,

Item [30], "23" should read -- 24 --.

Signed and Sealed this

Eleventh Day of December, 2001

Attest:

Nicholas P. Godici

Attesting Officer

NICHOLAS P. GODICI
Acting Director of the United States Patent and Trademark Office