



US00D440585S

(12) **United States Design Patent** (10) **Patent No.:** **US D440,585 S**
Kahn et al. (45) **Date of Patent:** **** Apr. 17, 2001**

(54) **VERTICALLY-ORIENTED DIGITAL CAMERA BODY WITH TOP-CENTERED SHUTTER BUTTON**

Primary Examiner—Adir Aronovich
(74) *Attorney, Agent, or Firm*—John A. Smart

(75) Inventors: **Philippe R. Kahn**, Scotts Valley;
Robin Goran Petravac; **Kurt Dammermann**, both of San Francisco;
Eric O. Bodnar, Santa Cruz, all of CA (US)

(57) **CLAIM**

The ornamental design for a vertically-oriented digital camera body with top-centered shutter button, as shown and described.

(73) Assignee: **LightSurf Technologies, Inc.**, Santa Cruz, CA (US)

DESCRIPTION

(**) Term: **14 Years**

The present application is related to the following commonly-owned applications: (1) Application Ser. No. 29/126,740, filed concurrently, and titled, Vertically-Oriented Digital Camera Body with Lens Assembly Reveal; (2) Application Ser. No. 29/126,738, filed concurrently, and titled, Vertically-Oriented Digital Camera Body with Connector Interface; and (3) Application Ser. No. 29/126,737, filed concurrently, and titled, Digital Camera Viewfinder with Graphic Display. The disclosures of the foregoing are hereby incorporated by reference.

(21) Appl. No.: **29/126,739**

(22) Filed: **Jul. 21, 2000**

(51) **LOC (7) Cl.** **16-01**

(52) **U.S. Cl.** **D16/200**

(58) **Field of Search** D16/200, 202, D16/203–205, 208, 218, 219, 237; 348/373–376, 838; 396/535–541

FIG. 1 is a top, left and front perspective view of a vertically-oriented digital camera body with top-centered shutter button, the broken lines are shown to illustrate environment only and form no part of the claimed design; FIG. 2 is a top, right, and front perspective view thereof; FIG. 3 is a front end view thereof; FIG. 4 is a rear end view thereof; FIG. 5 is a bottom, left, and front perspective view thereof; and, FIG. 6 is a top, left, and front perspective view showing a first modified form of our new design, the sole difference being minor lateral displacement of the shutter button to one side (or the other) of the camera body.

(56) **References Cited**

U.S. PATENT DOCUMENTS

D. 160,300	*	10/1950	Chapman	D16/200
D. 408,044	*	4/1999	Tanaka et al.	D16/202
D. 416,570	*	11/1999	Hsueh	D16/218
D. 428,429	*	7/2000	Garrison et al.	D16/202
D. 429,269	*	8/2000	Renkis	D16/203
D. 431,828	*	10/2000	Yoshida	D16/202
5,729,289	*	3/1998	Etoh	348/373
5,825,408	*	10/1998	Yuyama et al.	348/838

* cited by examiner

1 Claim, 6 Drawing Sheets

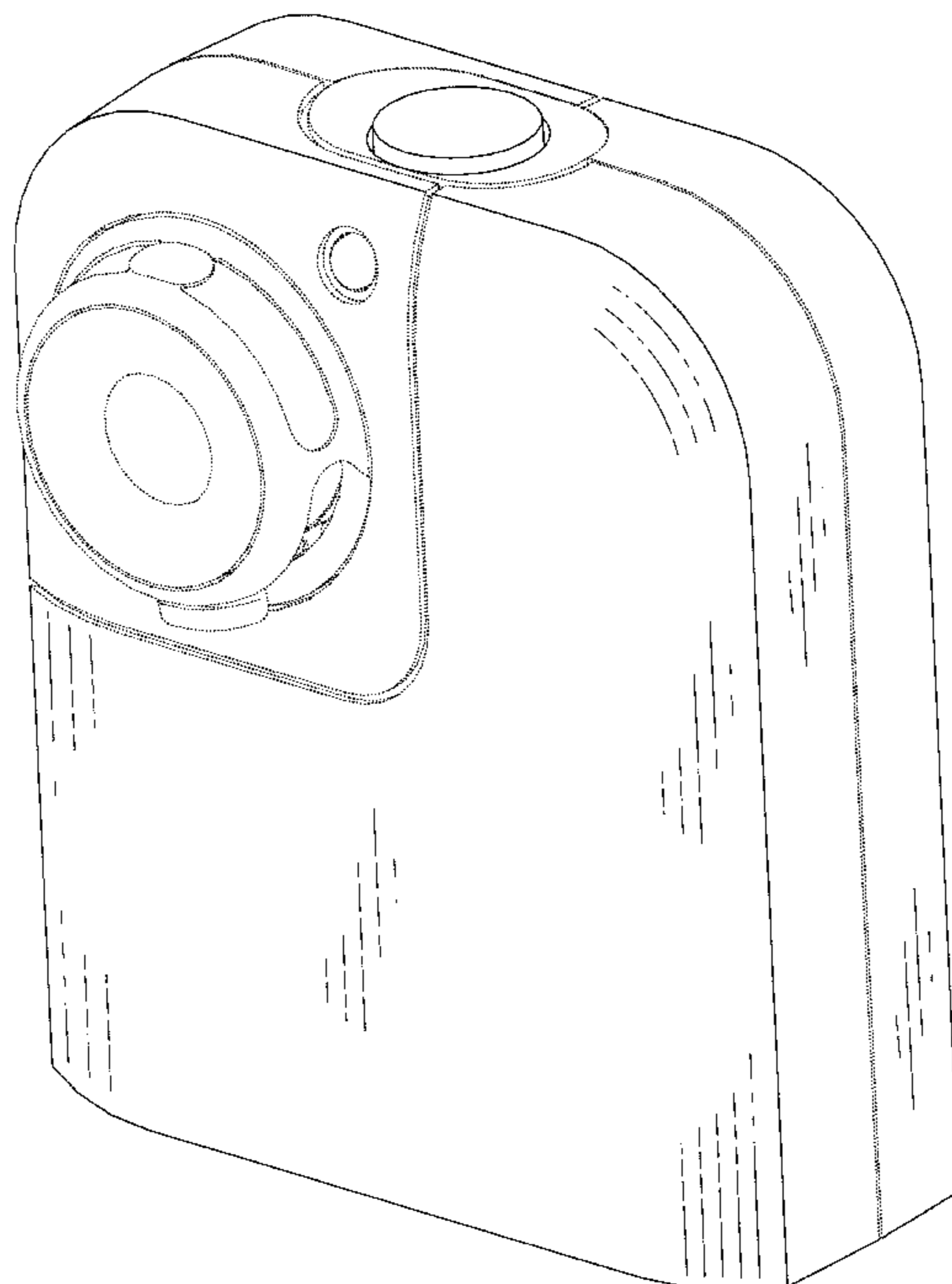

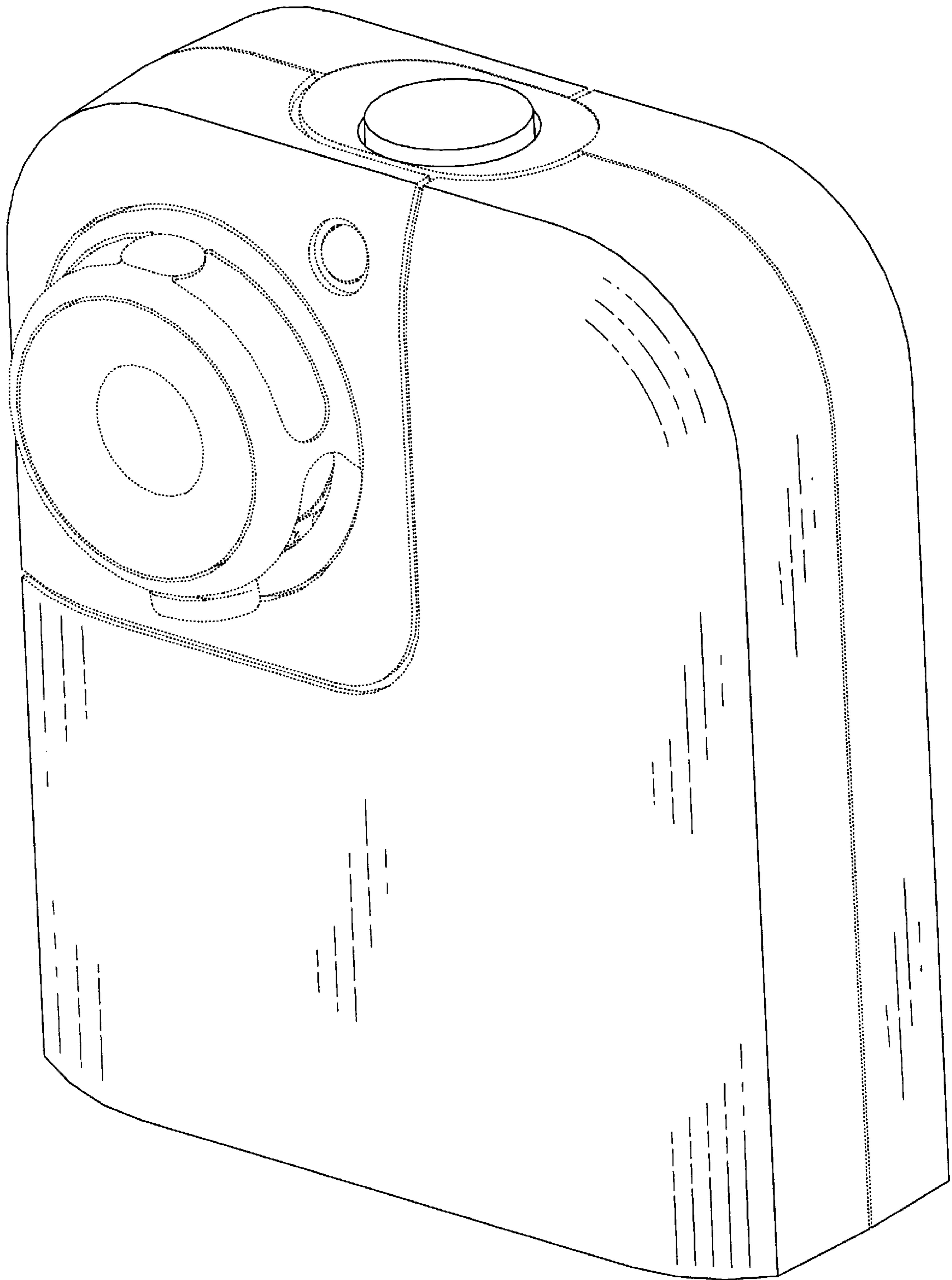

FIG. 1

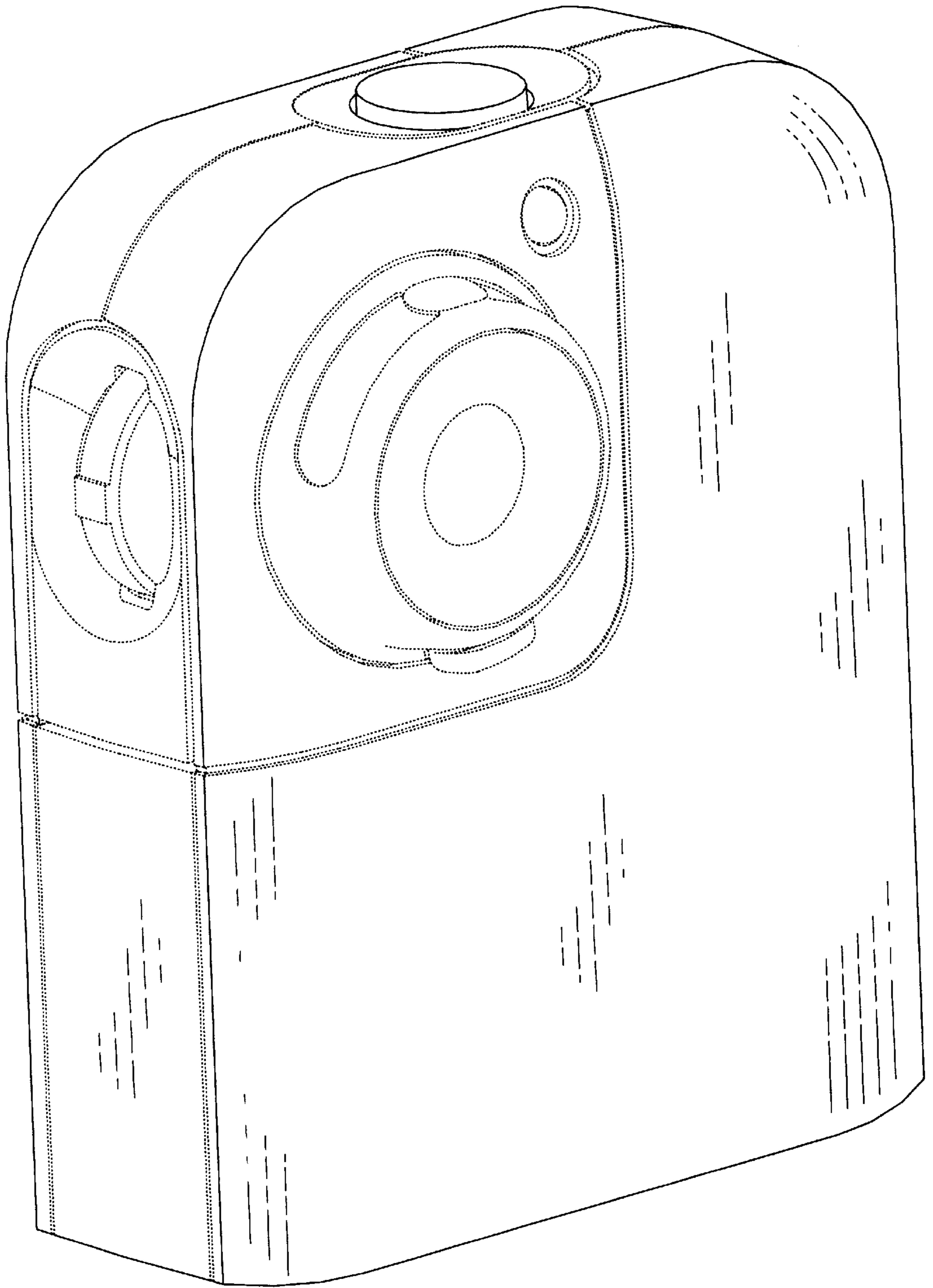

FIG. 2

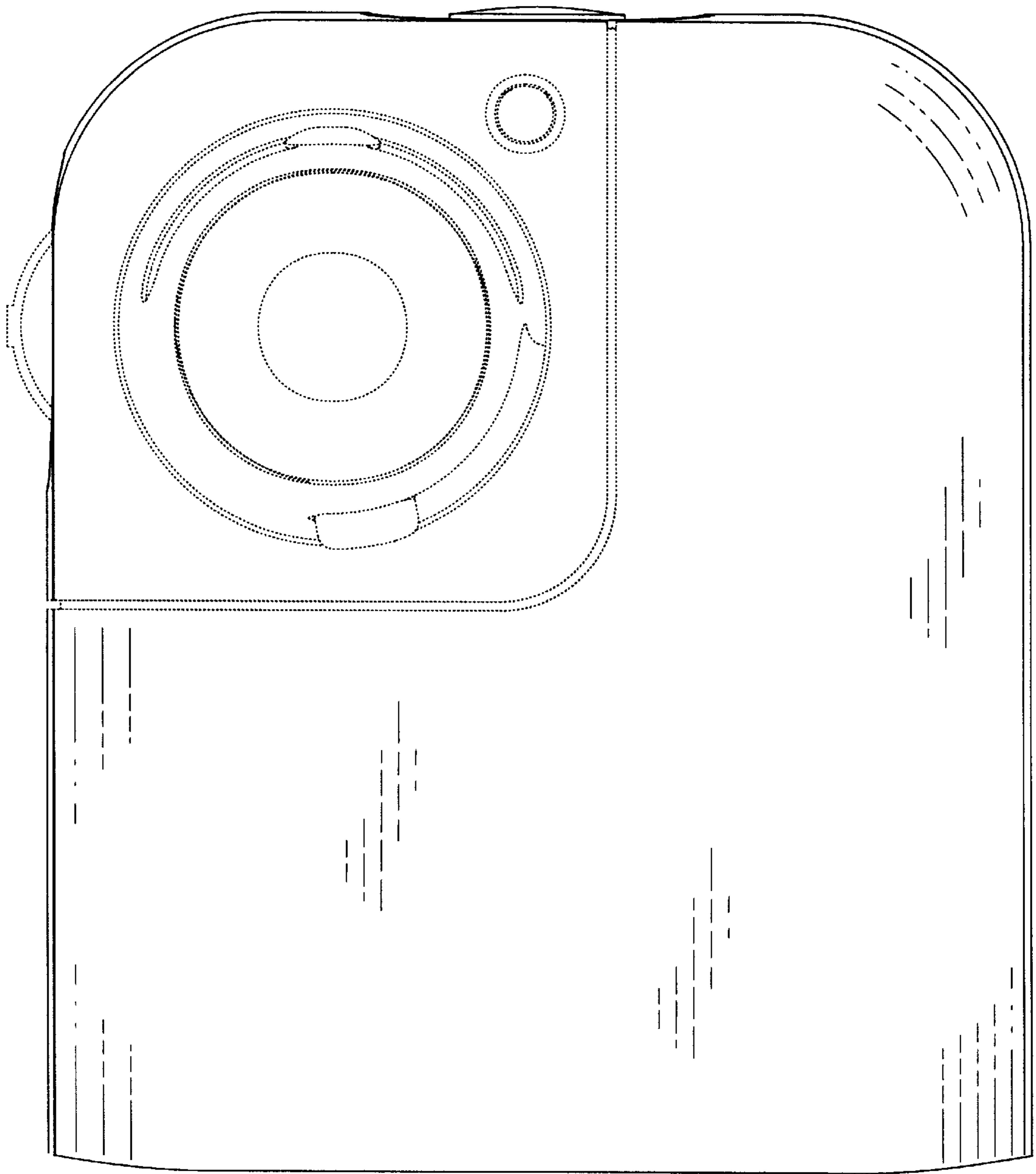

FIG. 3

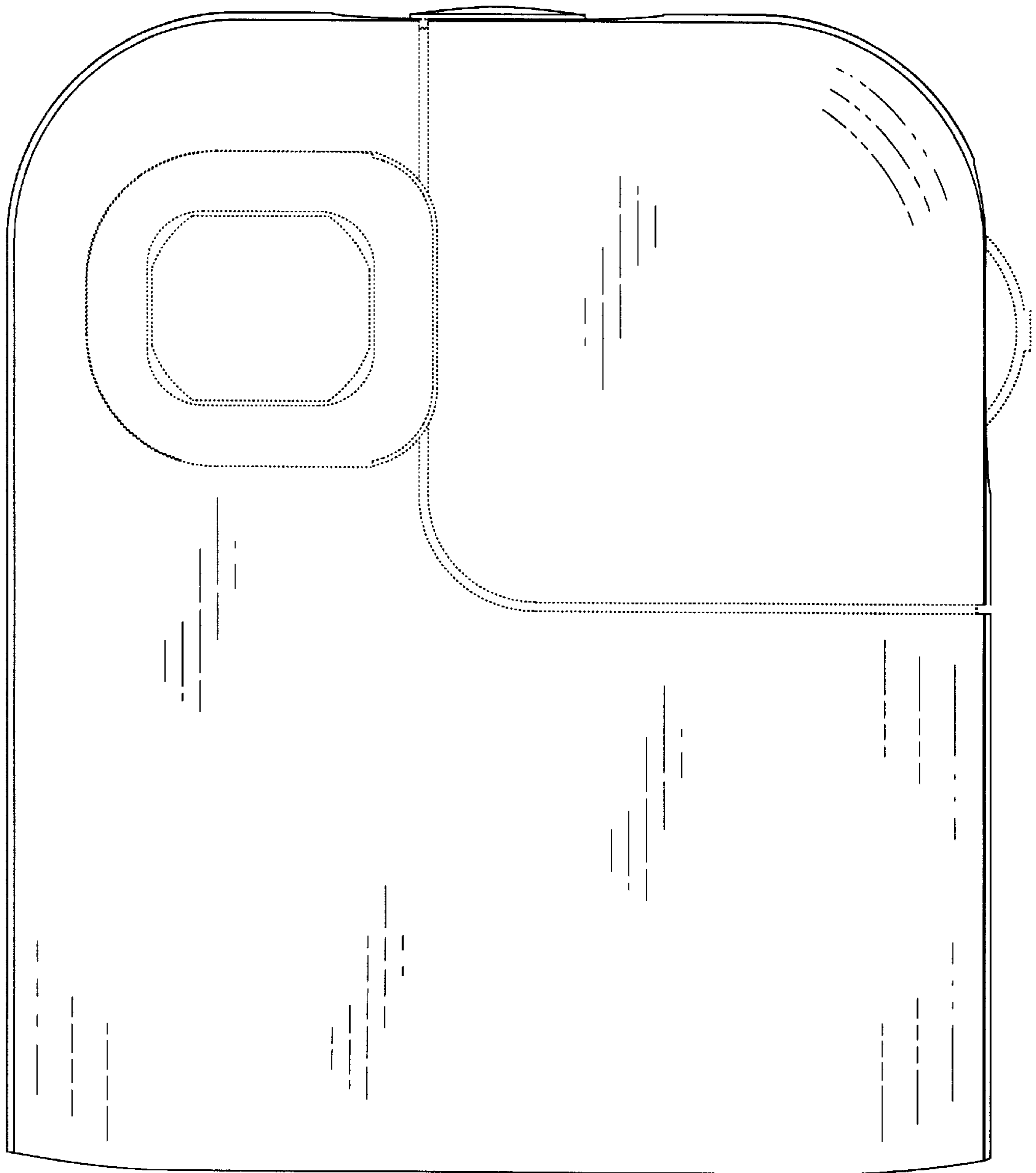

FIG. 4

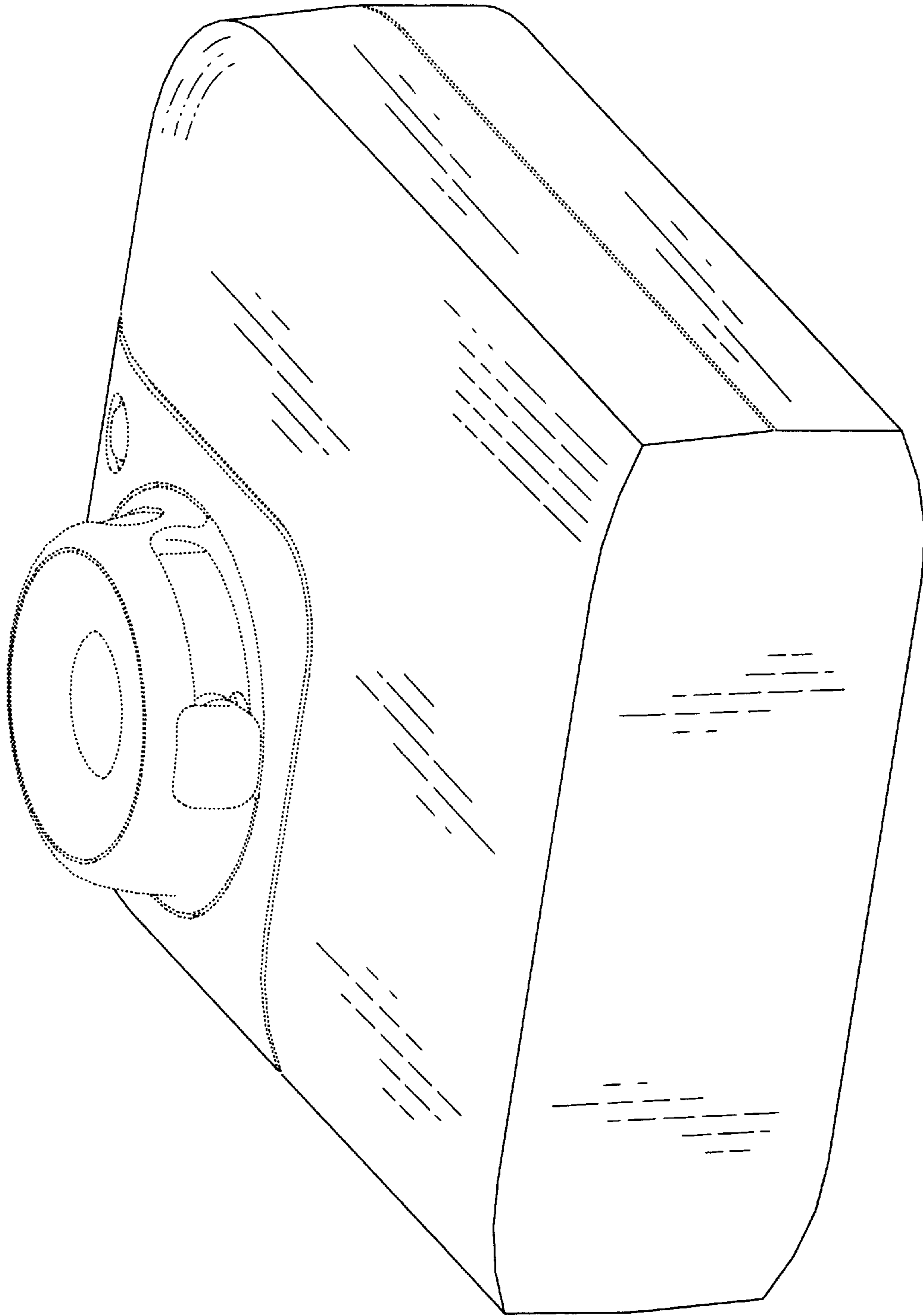

FIG. 5

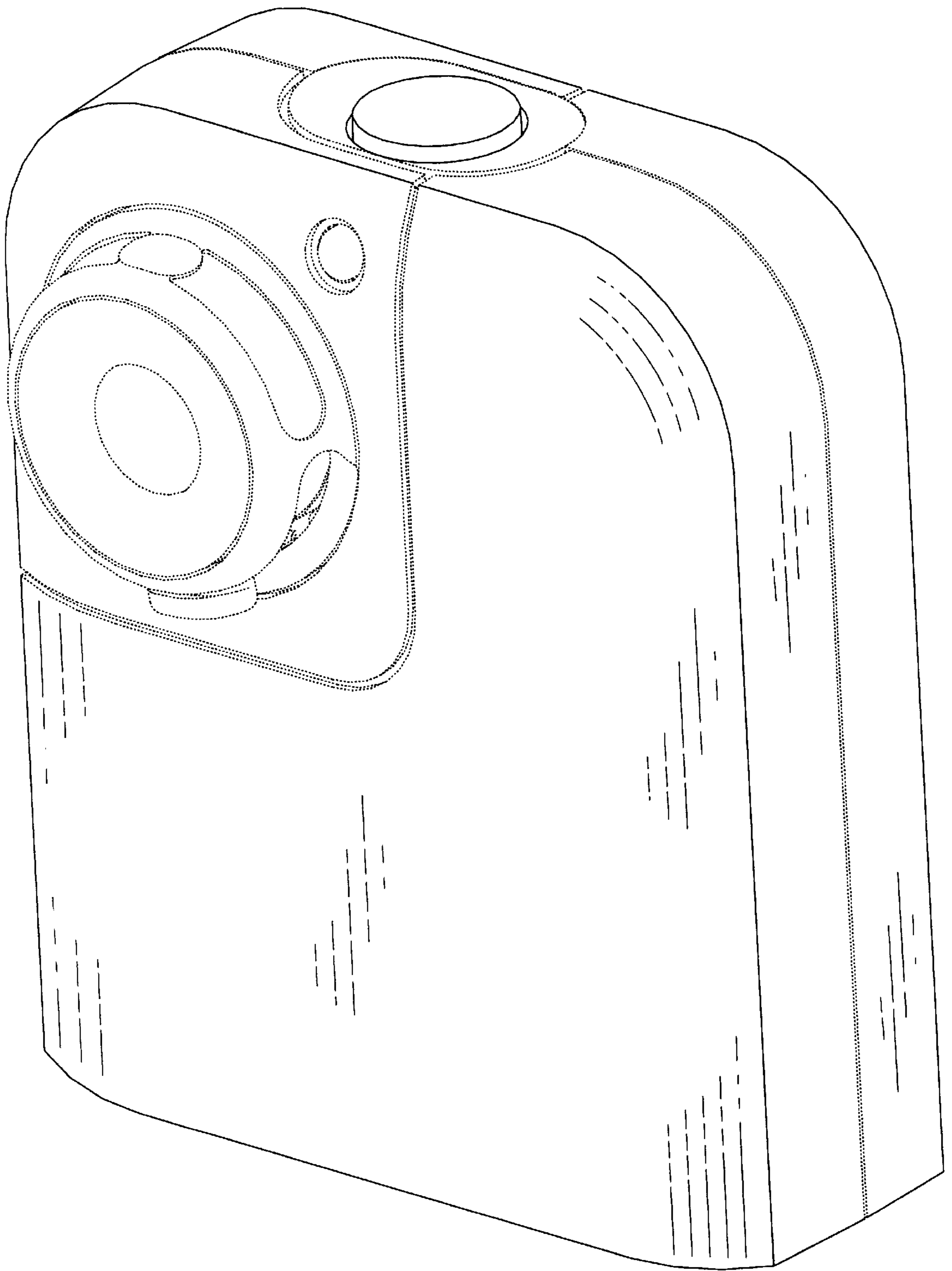

FIG. 6