



US00D440562S

(12) **United States Design Patent**
Gottlieb et al.

(10) **Patent No.:** **US D440,562 S**

(45) **Date of Patent:** **** Apr. 17, 2001**

(54) **E-MAIL NOTIFICATION DEVICE**

(75) Inventors: **Mark M. Gottlieb**, Fairfax Station, VA (US); **Mark McLean-Blevins**, Westminster, MD (US)

(73) Assignee: **Designtech International, Inc.**, Springfield, VA (US)

(**) Term: **14 Years**

(21) Appl. No.: **29/121,720**

(22) Filed: **Apr. 13, 2000**

Related U.S. Application Data

(62) Division of application No. 09/453,887, filed on Feb. 29, 2000.

(51) **LOC (7) Cl.** **14-02**

(52) **U.S. Cl.** **D14/341**

(58) **Field of Search** D14/341, 191, D14/345, 346; D18/7; 235/145 A, 145 R; 345/156, 168, 169, 172; 341/22, 23; 364/708.1; 709/217, 203, 200; D10/65

(56) **References Cited**

U.S. PATENT DOCUMENTS

D. 313,401	*	1/1991	Tanabe	D14/346
D. 359,920	*	7/1995	Sakamoto	D10/65
5,896,533	*	4/1999	Ramos et al.	709/217
5,964,830	*	10/1999	Durrett	709/200
6,038,594	*	3/2000	Puente et al.	709/217

* cited by examiner

Primary Examiner—Freda Nunn

(74) *Attorney, Agent, or Firm*—Oblon, Spivak, McClelland, Maier & Neustadt, P.C.

(57) **CLAIM**

The ornamental design for an e-mail notification device, as shown and described.

DESCRIPTION

FIG. 1 is a top and right front perspective view of an e-mail notification device showing our design;
 FIG. 2 is a bottom and left rear perspective view thereof;
 FIG. 3 is a front elevational view thereof;
 FIG. 4 is a rear elevational view thereof;
 FIG. 5 is a top plan view thereof;
 FIG. 6 is a right side elevational view thereof, the left side elevational view being a mirror image of the side view shown;
 FIG. 7 is a bottom plan view thereof;
 FIG. 8 is a top and right front perspective view of a second embodiment thereof;
 FIG. 9 is a bottom and left rear perspective view thereof;
 FIG. 10 is a front elevational view thereof;
 FIG. 11 is a rear elevational view thereof;
 FIG. 12 is a top plan view thereof;
 FIG. 13 is a right side elevational view thereof, the left side elevational view being a mirror image of the side view shown;
 FIG. 14 is a bottom plan view thereof; and,
 FIG. 15 is a perspective view thereof showing a pivotable stand thereof when in use.
 The broken line showing in the figures is for illustrative purposes only and forms no part of the claimed design.

1 Claim, 8 Drawing Sheets

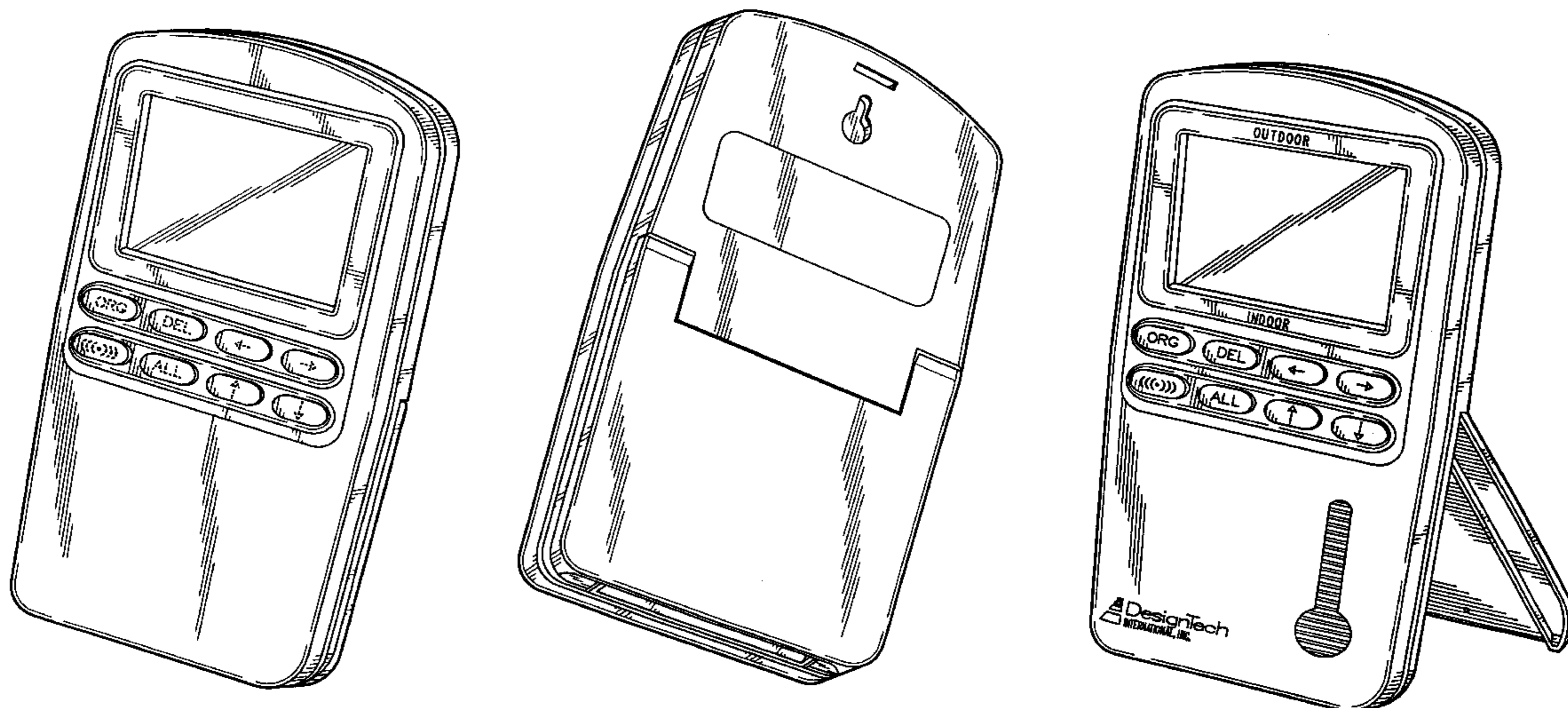

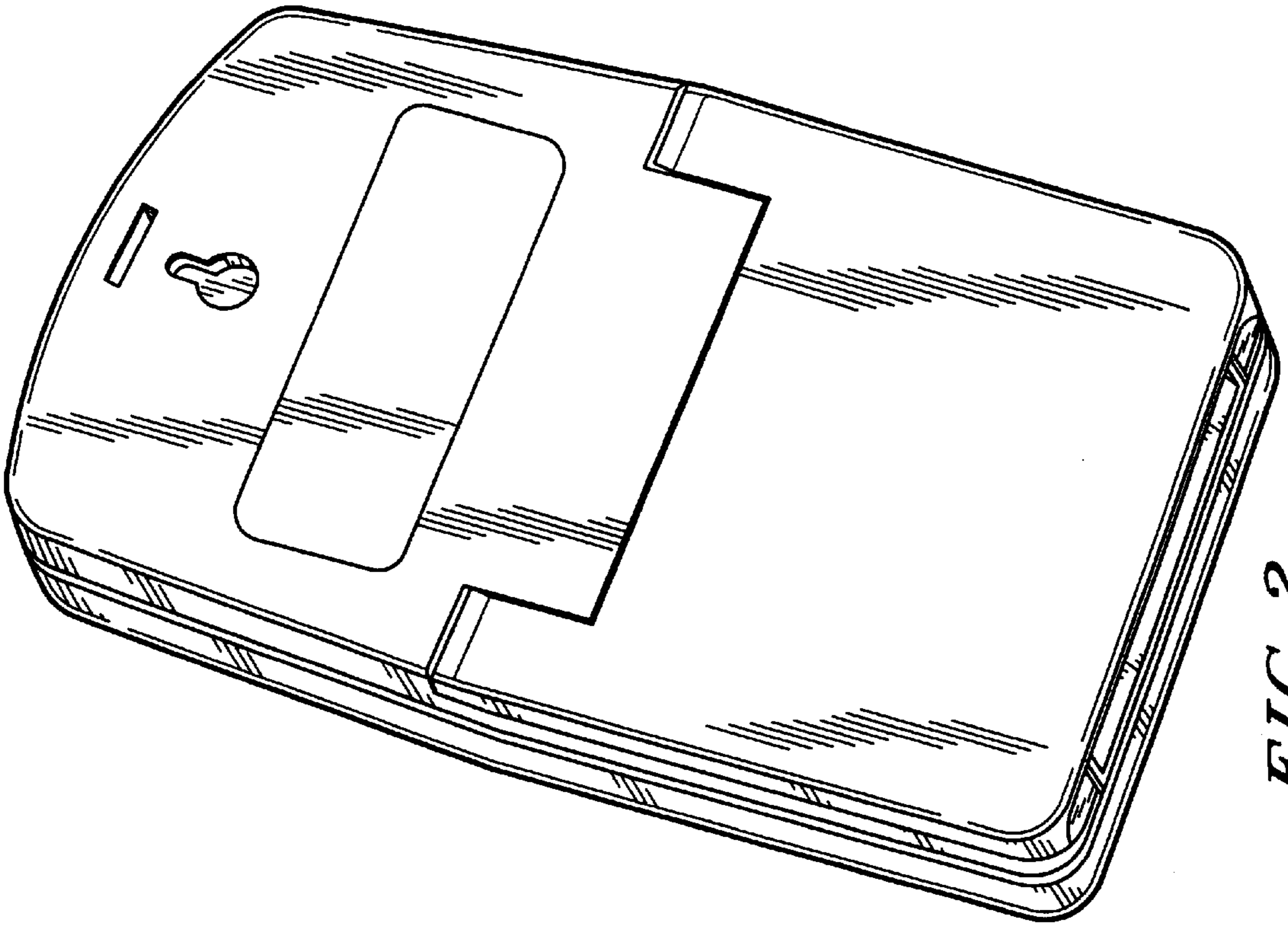

FIG. 2

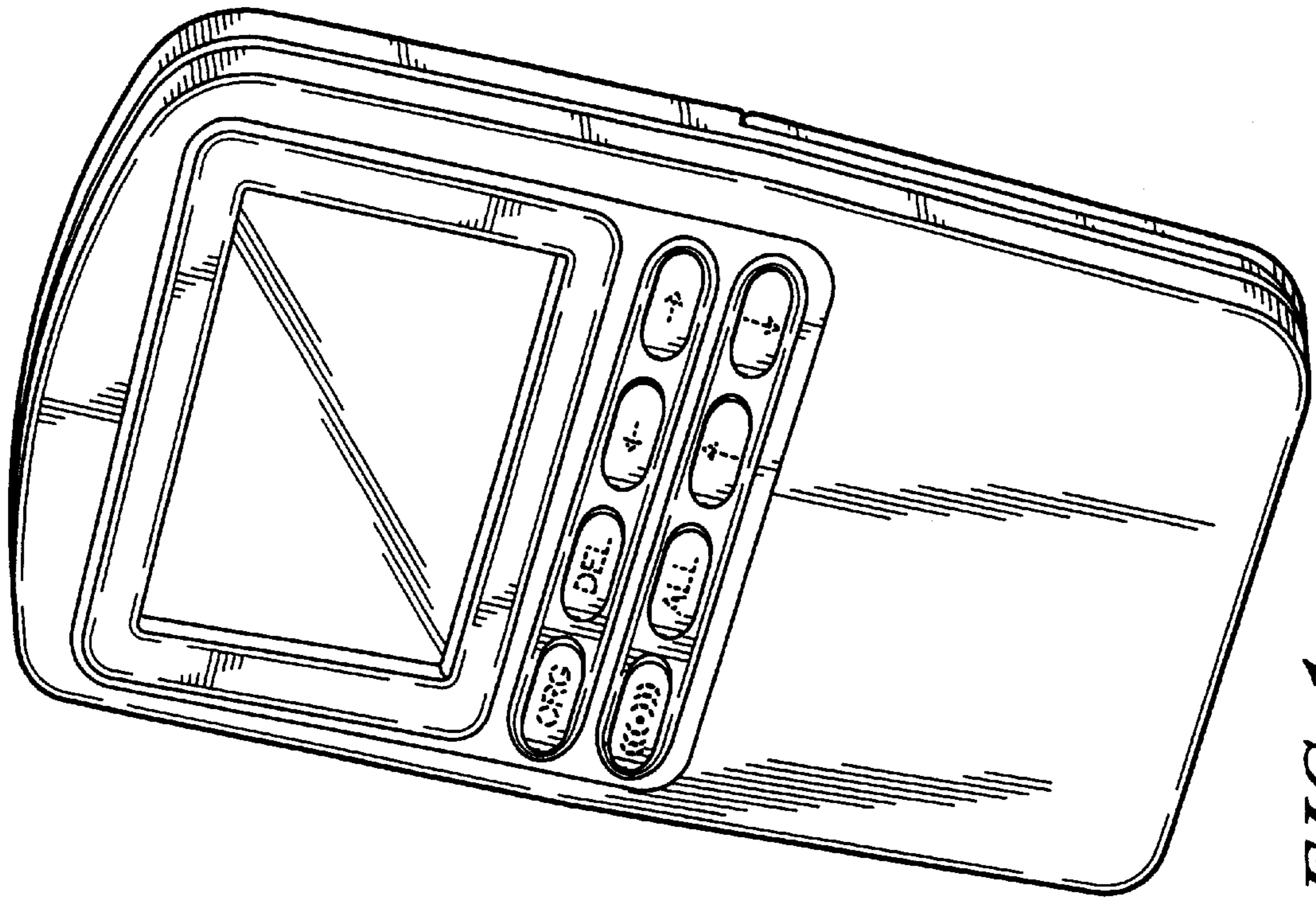

FIG. 1

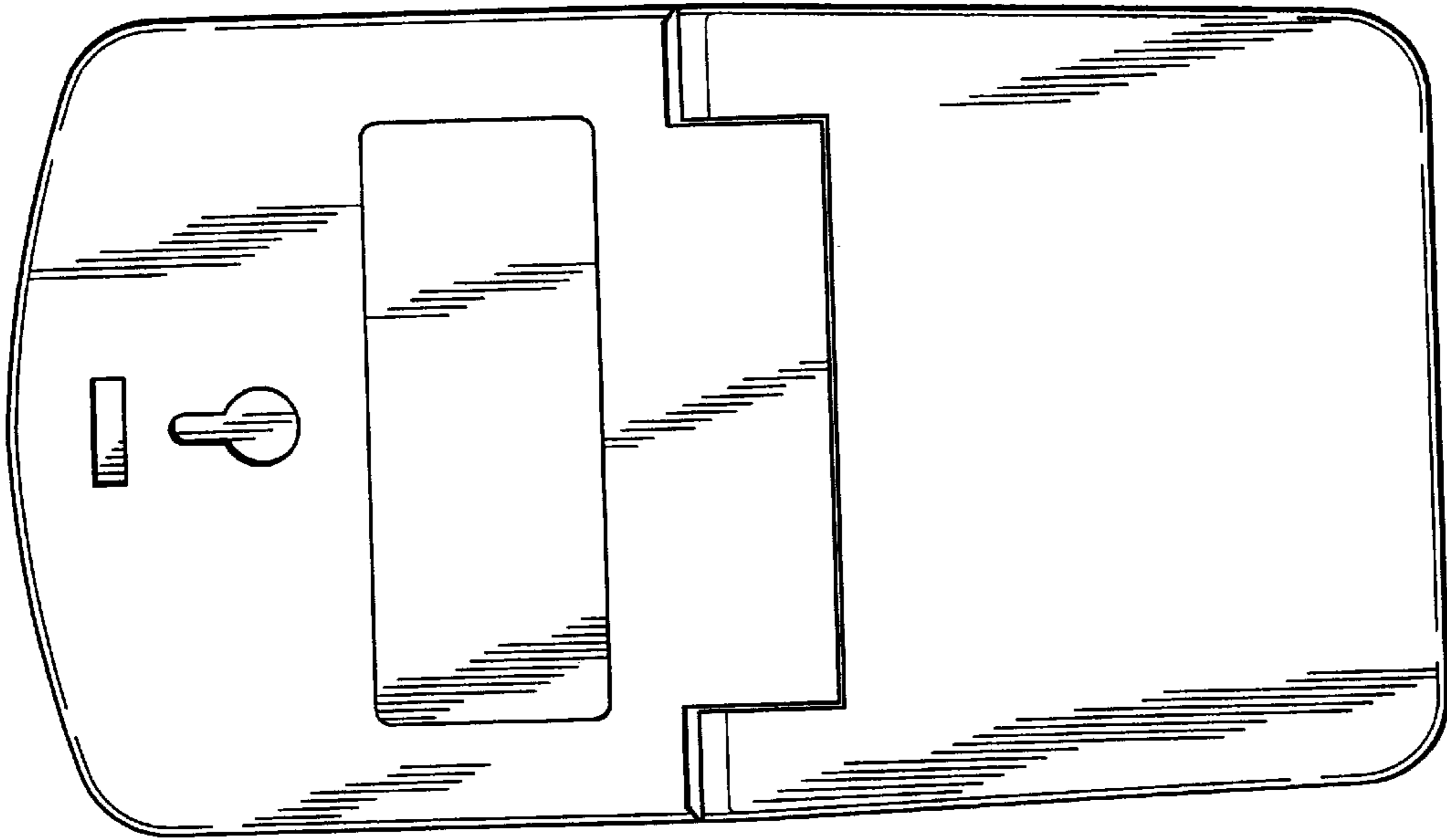

FIG. 4

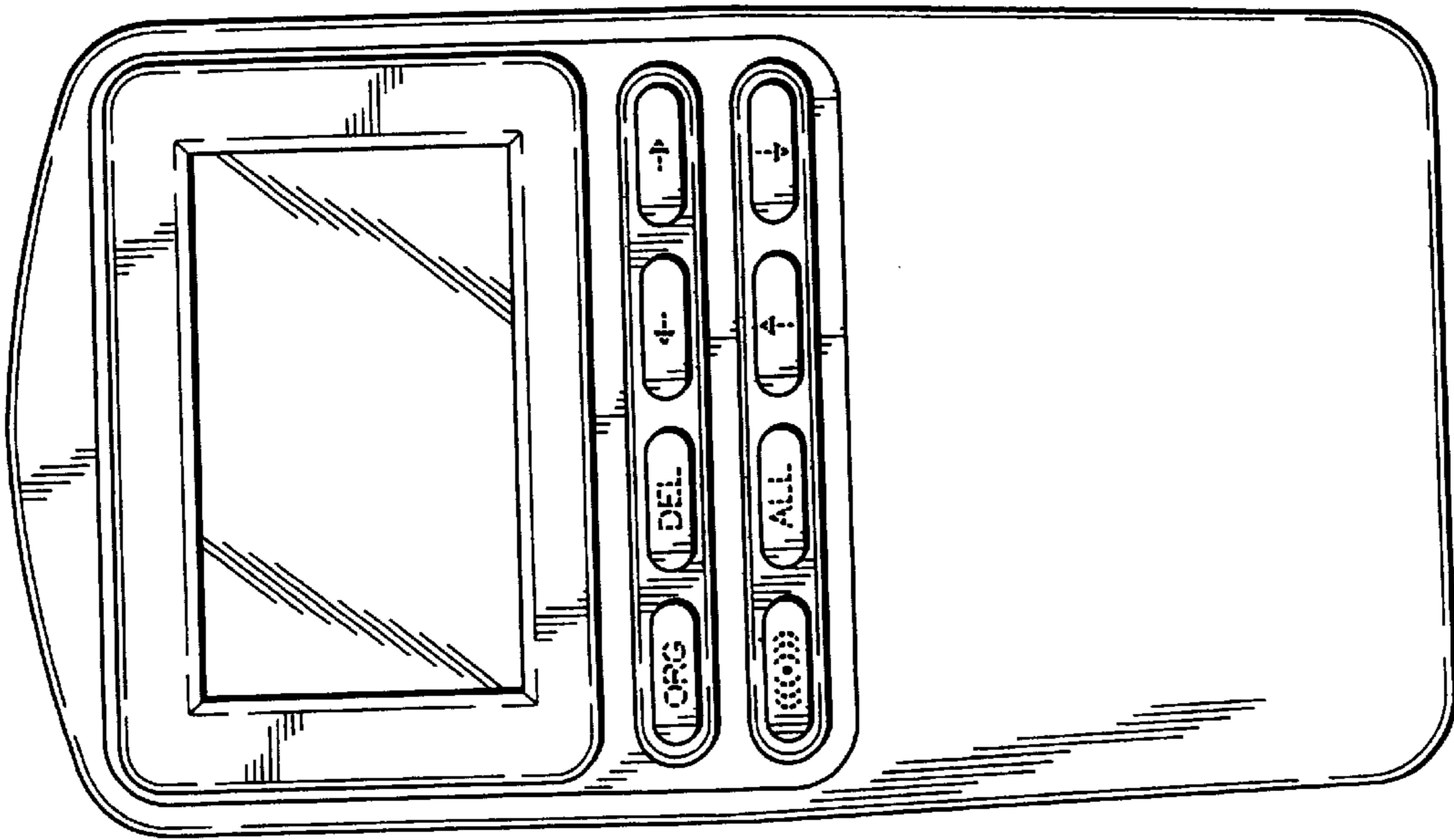

FIG. 3

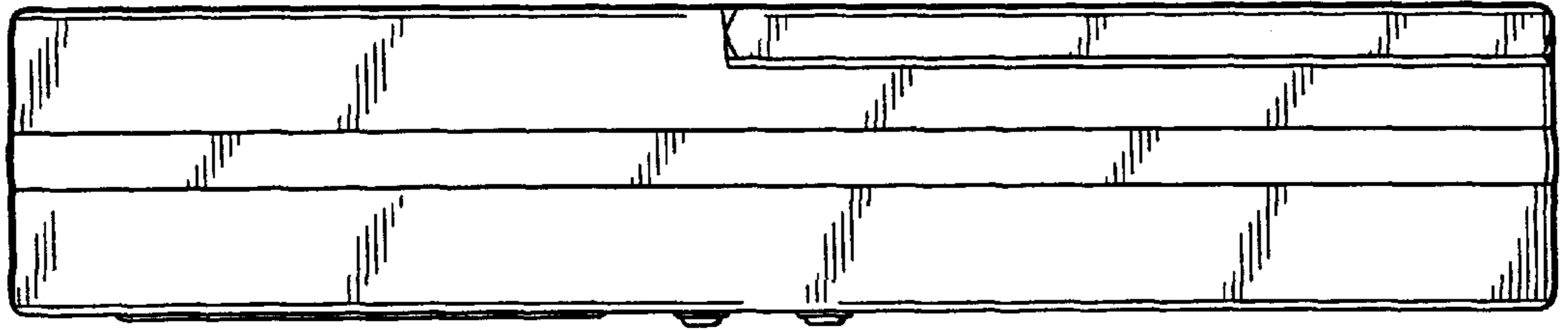

FIG. 6

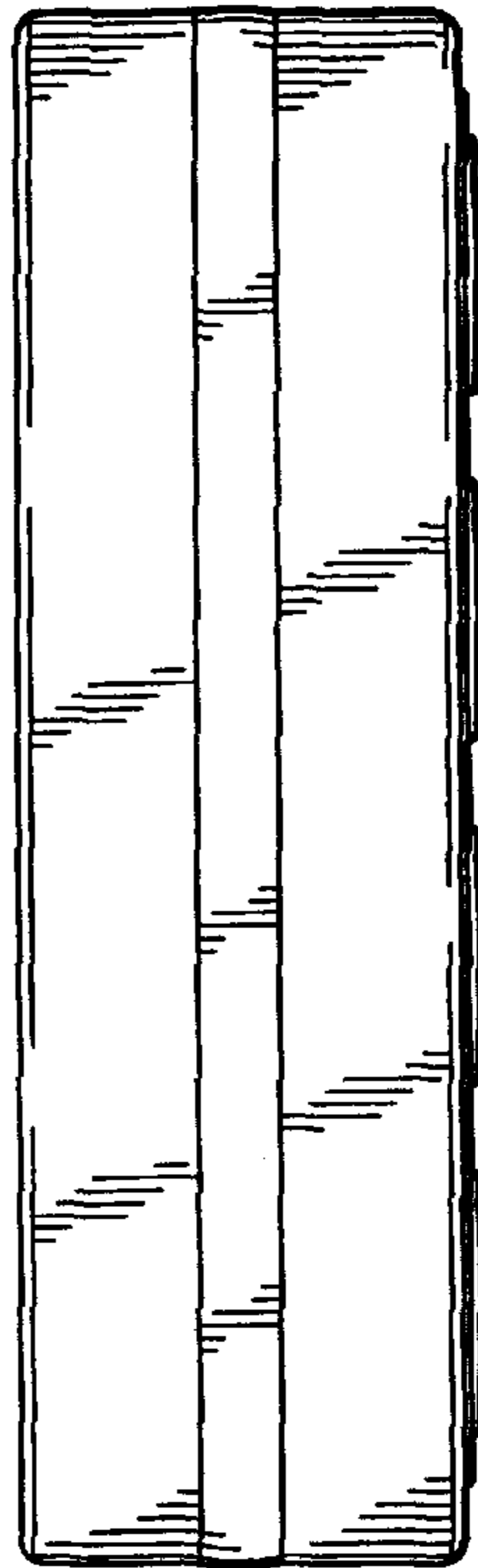

FIG. 5

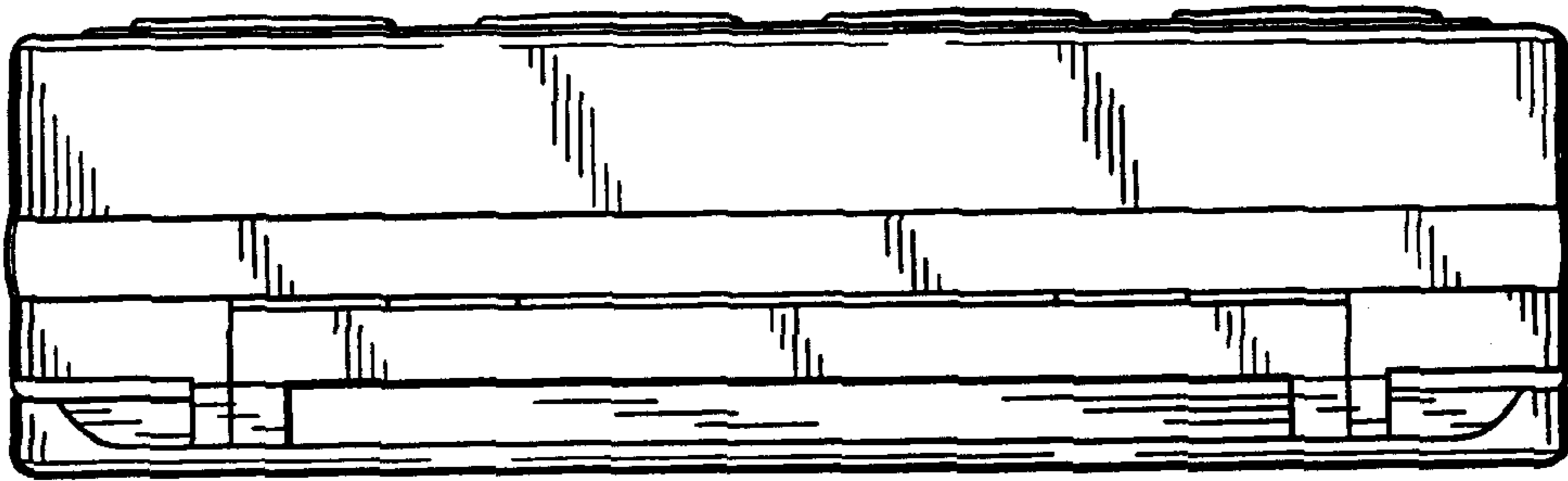

FIG. 7

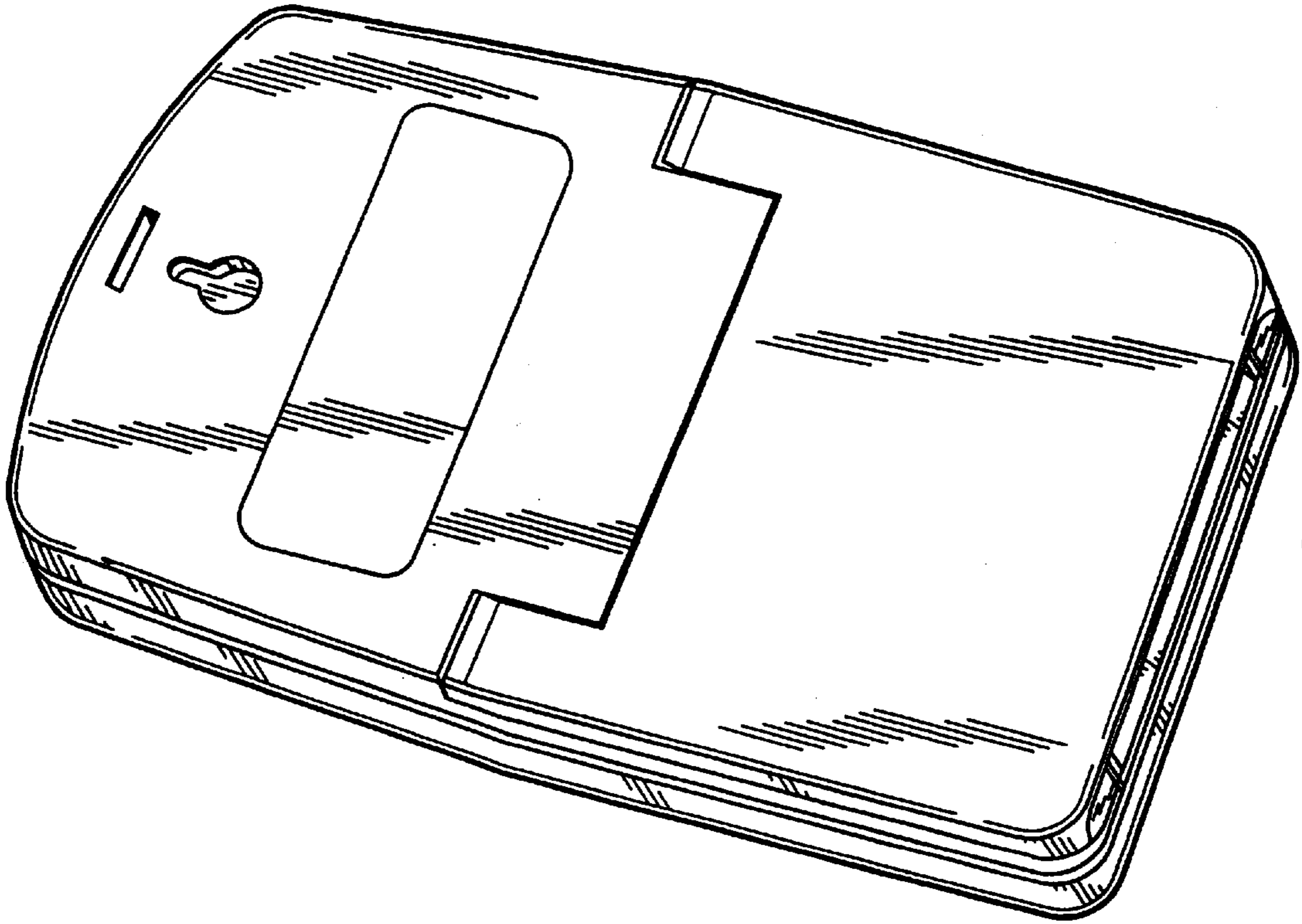

FIG. 9

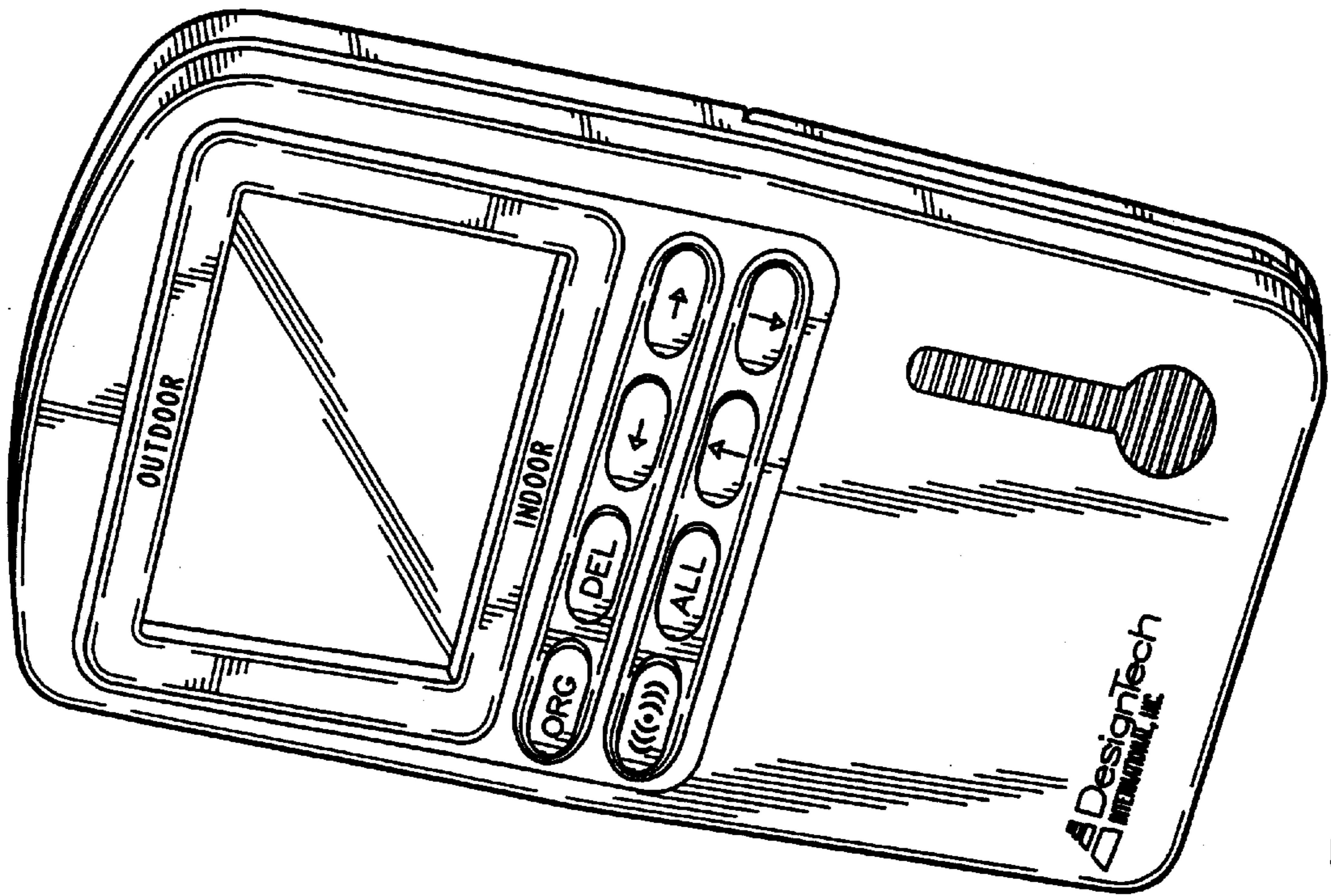

FIG. 8

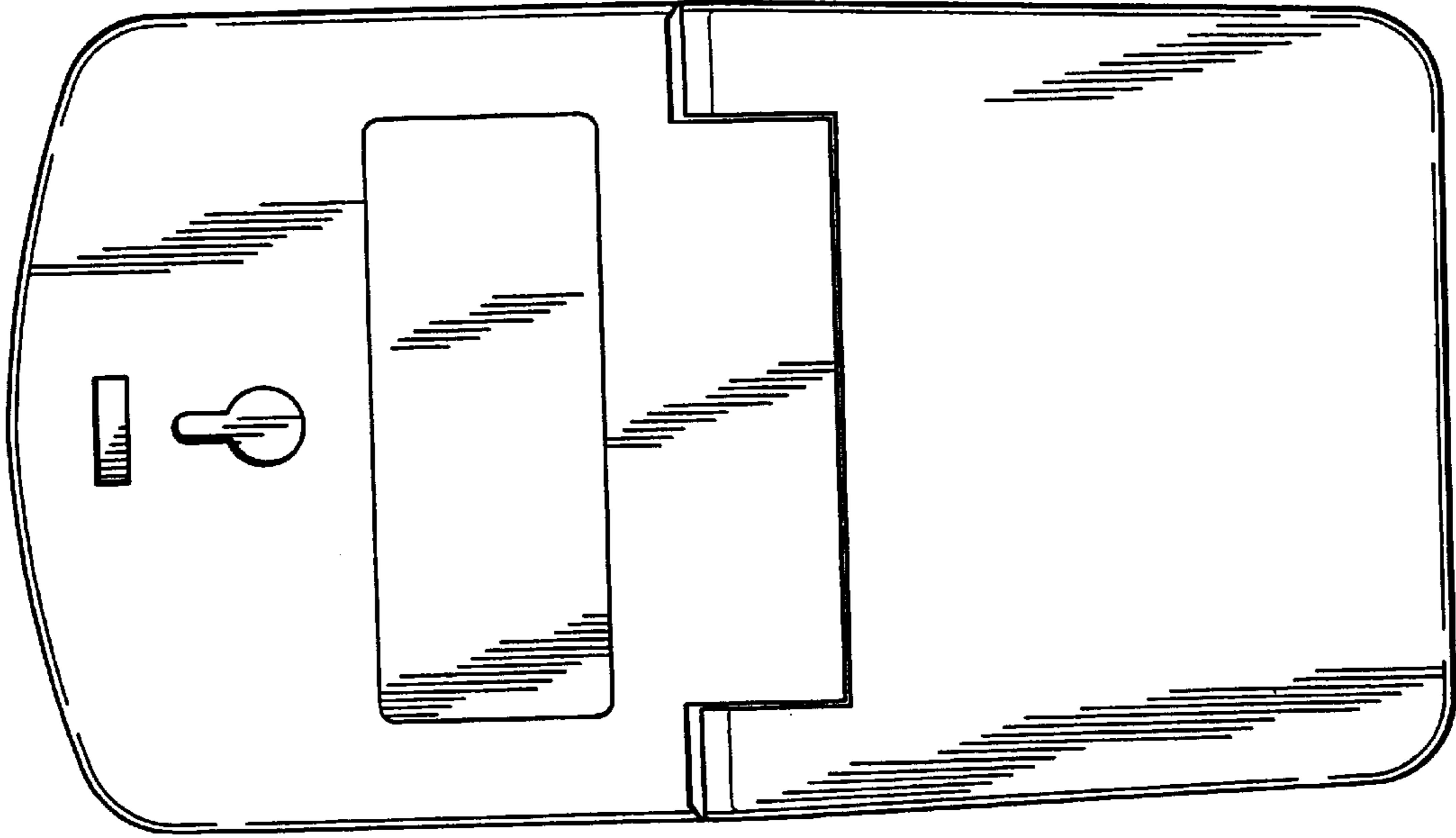

FIG. 11

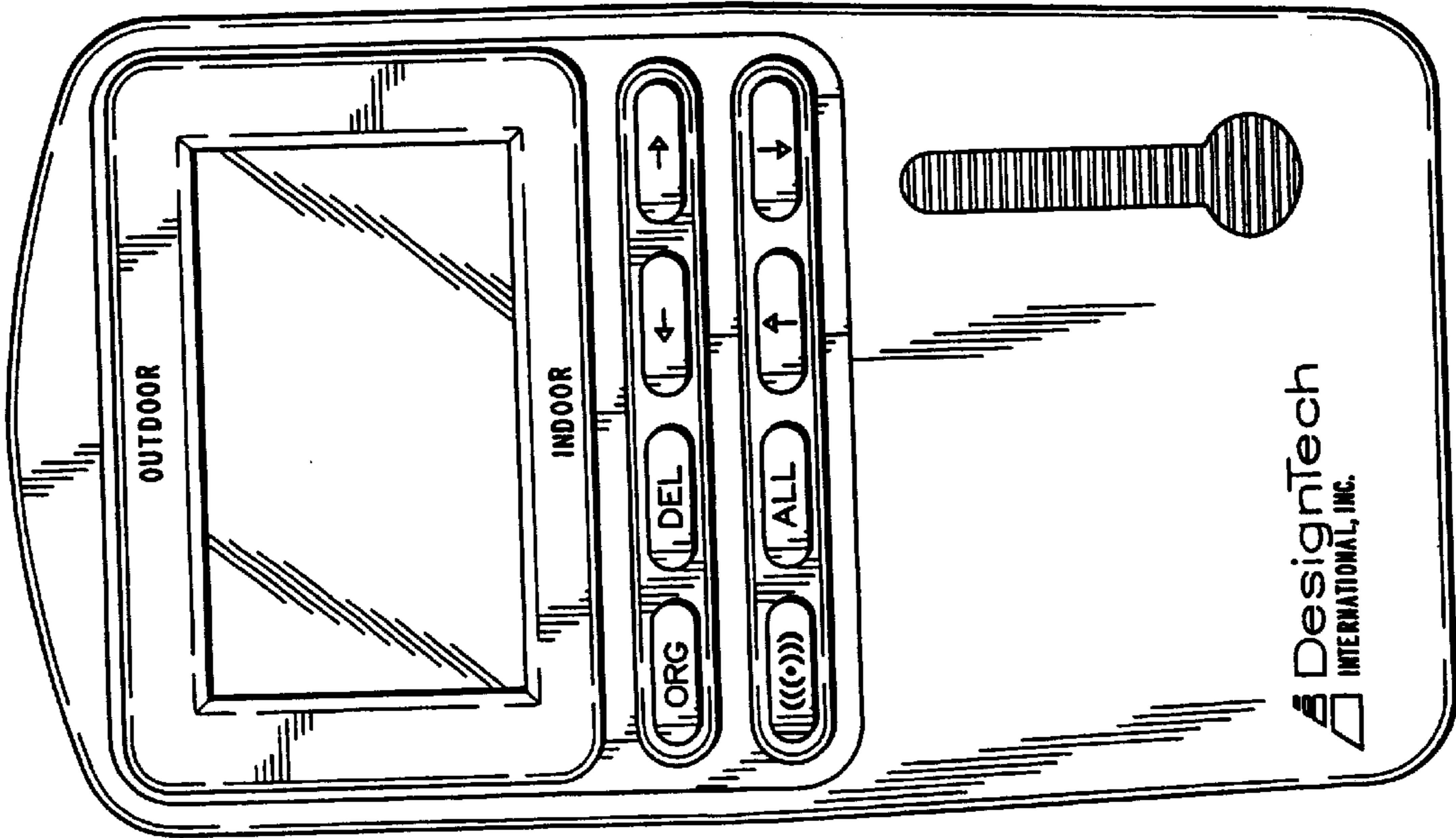

FIG. 10

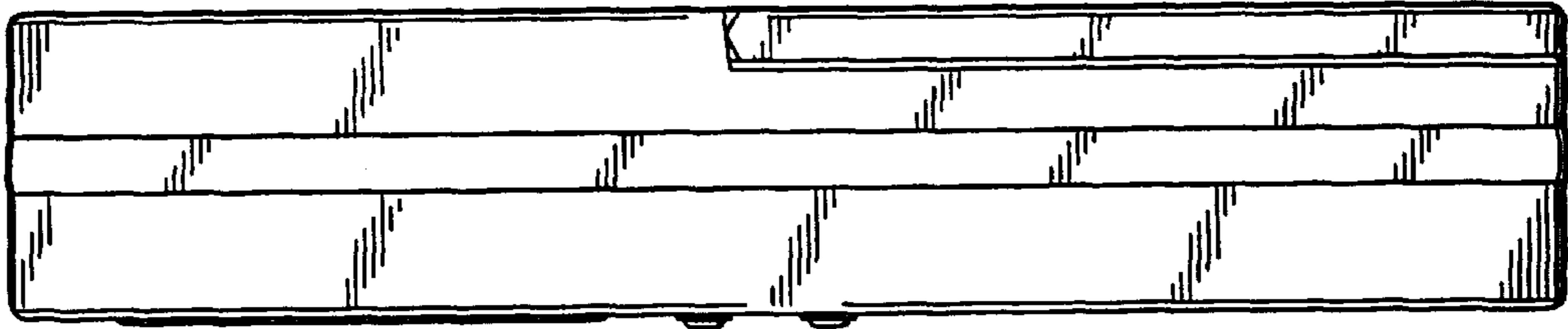

FIG. 13

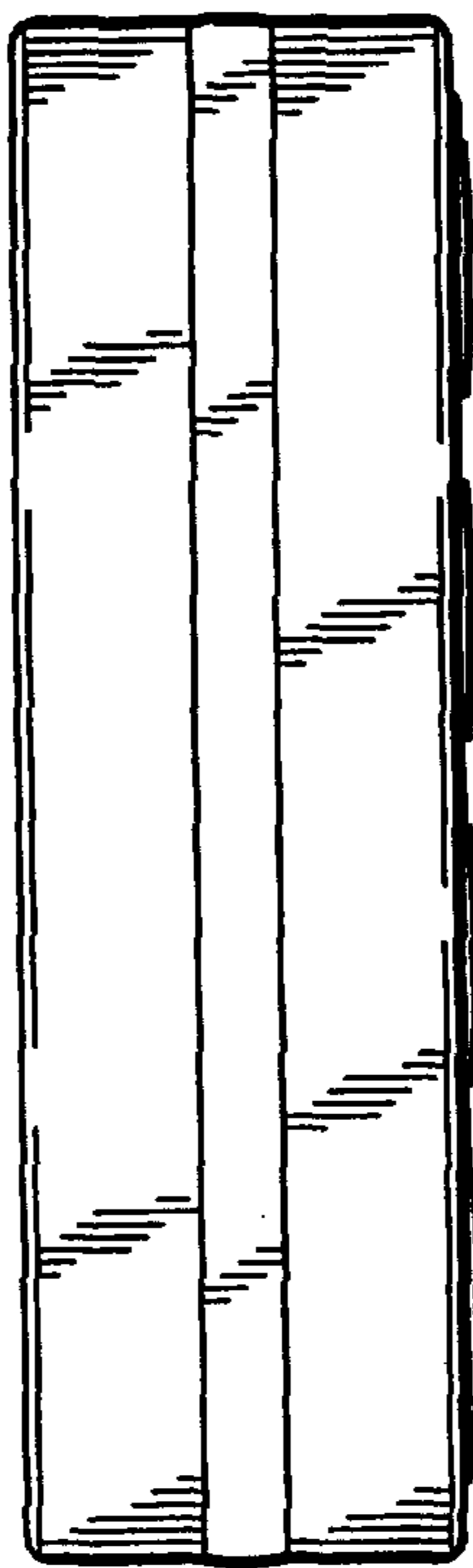

FIG. 12

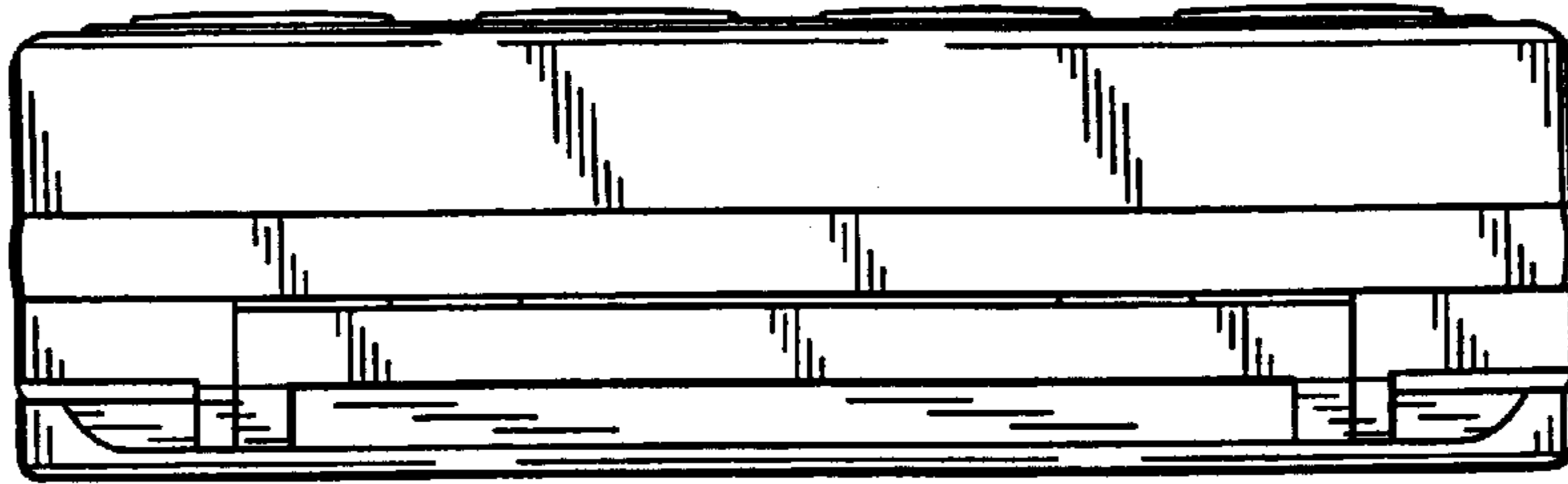

FIG. 14

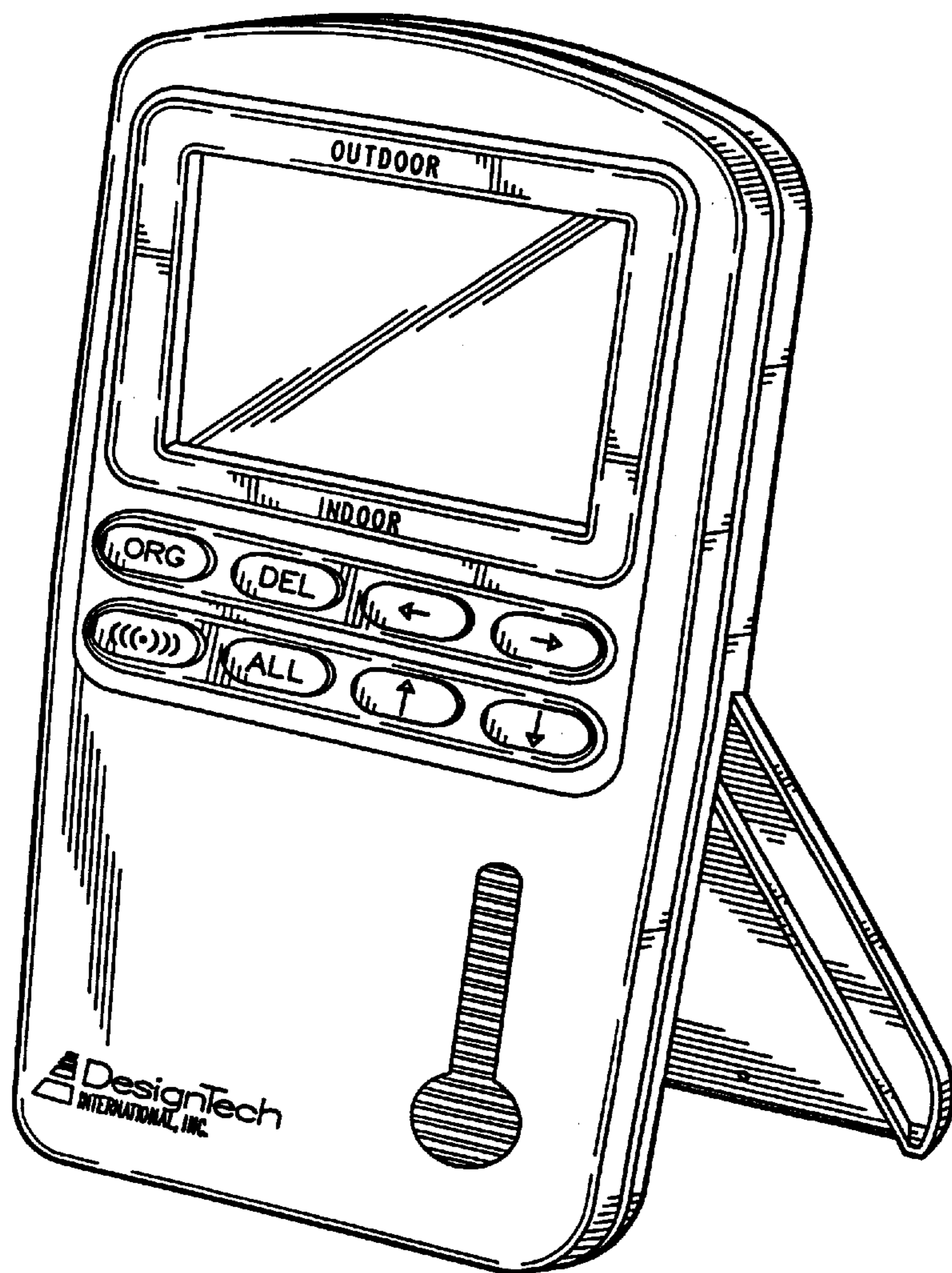

FIG. 15

UNITED STATES PATENT AND TRADEMARK OFFICE
CERTIFICATE OF CORRECTION

PATENT NO. : Des 440,562
DATED : April 17, 2001
INVENTOR(S) : Gottlieb et al.

Page 1 of 1

It is certified that error appears in the above-identified patent and that said Letters Patent is hereby corrected as shown below:

Title page, item (75),

The 2nd Inventor's name is incorrect, item (75) should read as follows:

-- (75) Inventors: Mark M. Gottlieb, Fairfax, Station, VA
(US); Mark MacLean-Blevins,
Westminster, MD (US) --

Signed and Sealed this

Second Day of October, 2001

Attest:

Nicholas P. Godici

Attesting Officer

NICHOLAS P. GODICI
Acting Director of the United States Patent and Trademark Office