



US00D440527S

(12) **United States Design Patent**  
**Wagner et al.**

(10) **Patent No.:** **US D440,527 S**

(45) **Date of Patent:** **\*\* Apr. 17, 2001**

(54) **AUTOMOBILE BODY**

(75) Inventors: **Lance R. Wagner**, Lake Orion; **John E. Crain**, Birmingham; **Mark D. Hall**, Rochester, all of MI (US)

(73) Assignee: **DaimlerChrysler Corporation**, Auburn Hills, MI (US)

(\*\*) Term: **14 Years**

(21) Appl. No.: **29/116,695**

(22) Filed: **Jan. 7, 2000**

(51) **LOC (7) Cl.** ..... **12-08**

(52) **U.S. Cl.** ..... **D12/92**

(58) **Field of Search** ..... D12/90-92; 296/185

(56) **References Cited**

**U.S. PATENT DOCUMENTS**

D. 345,719	4/1994	Anness et al.	.....	D12/92
D. 347,200	5/1994	Anness et al.	.....	D12/92
D. 350,086	8/1994	Kong et al.	.....	D12/92
D. 351,573	10/1994	Kong et al.	.....	D12/92
D. 366,231	1/1996	Wagner et al.	.....	D12/92
D. 408,328	4/1999	Ayoub et al.	.....	D12/92
D. 415,719	* 10/1999	Sawai et al.	.....	D12/92

\* cited by examiner

*Primary Examiner*—Melody N. Brown

(74) *Attorney, Agent, or Firm*—Mark P. Calcaterra

(57) **CLAIM**

The ornamental design for an automobile body, as shown and described.

**DESCRIPTION**

FIG. 1 is a perspective view of the front and left side of a vehicle body showing our new design;

FIG. 2 is a perspective view of the rear and left side thereof;

FIG. 3 is a left side view thereof, it being understood that the opposite side not shown is a substantial mirror image thereof;

FIG. 4 is a front view thereof;

FIG. 5 is a rear view thereof;

FIG. 6 is a front and left side perspective view of an alternative embodiment, the sole difference being the elimination of fog lamps from the front fascia; and,

FIG. 7 is a front view thereof.

It will be understood that the hidden line showing throughout the drawings is for illustrative purposes only and forms no part of the subject design.

**1 Claim, 6 Drawing Sheets**

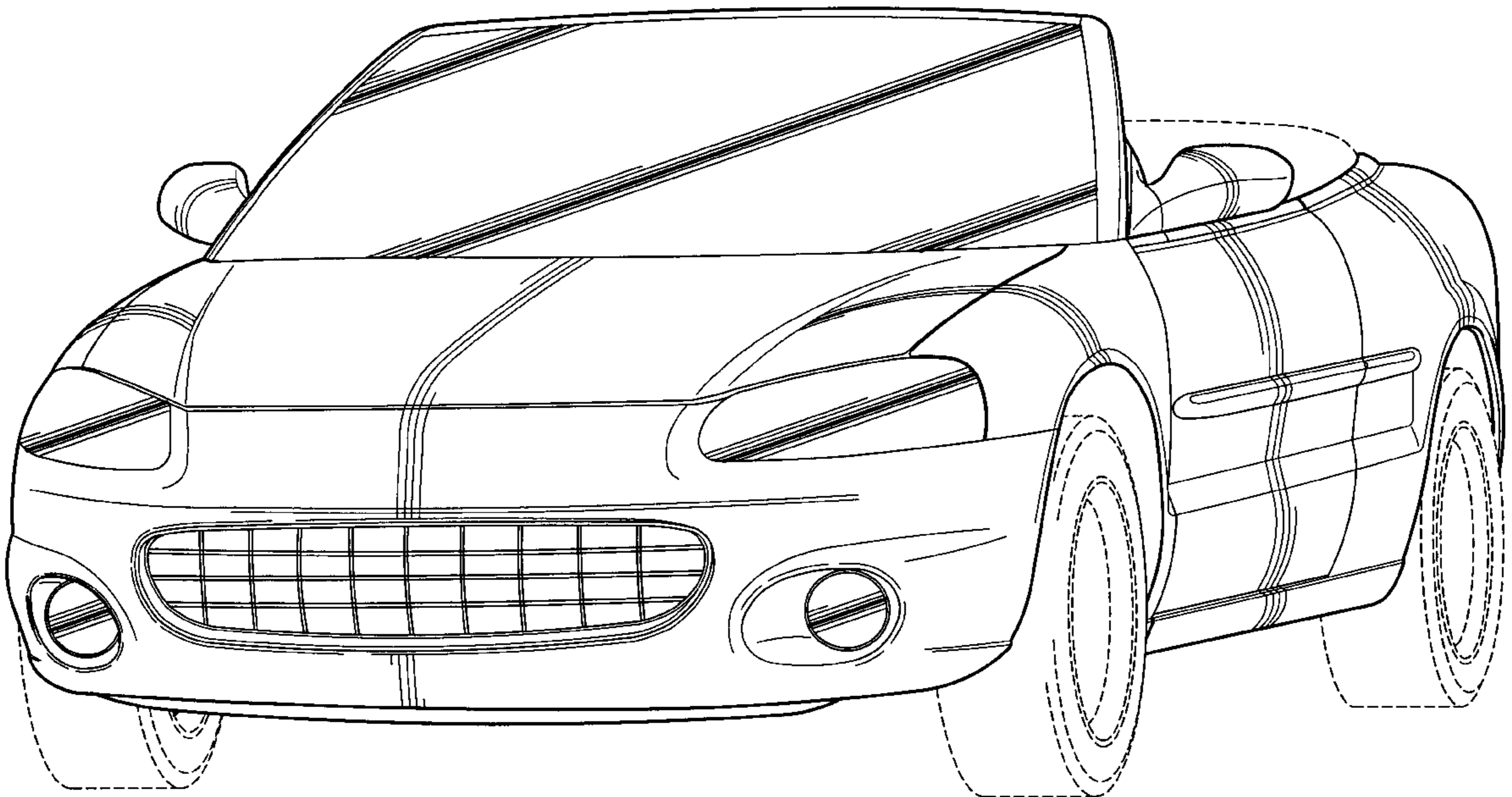

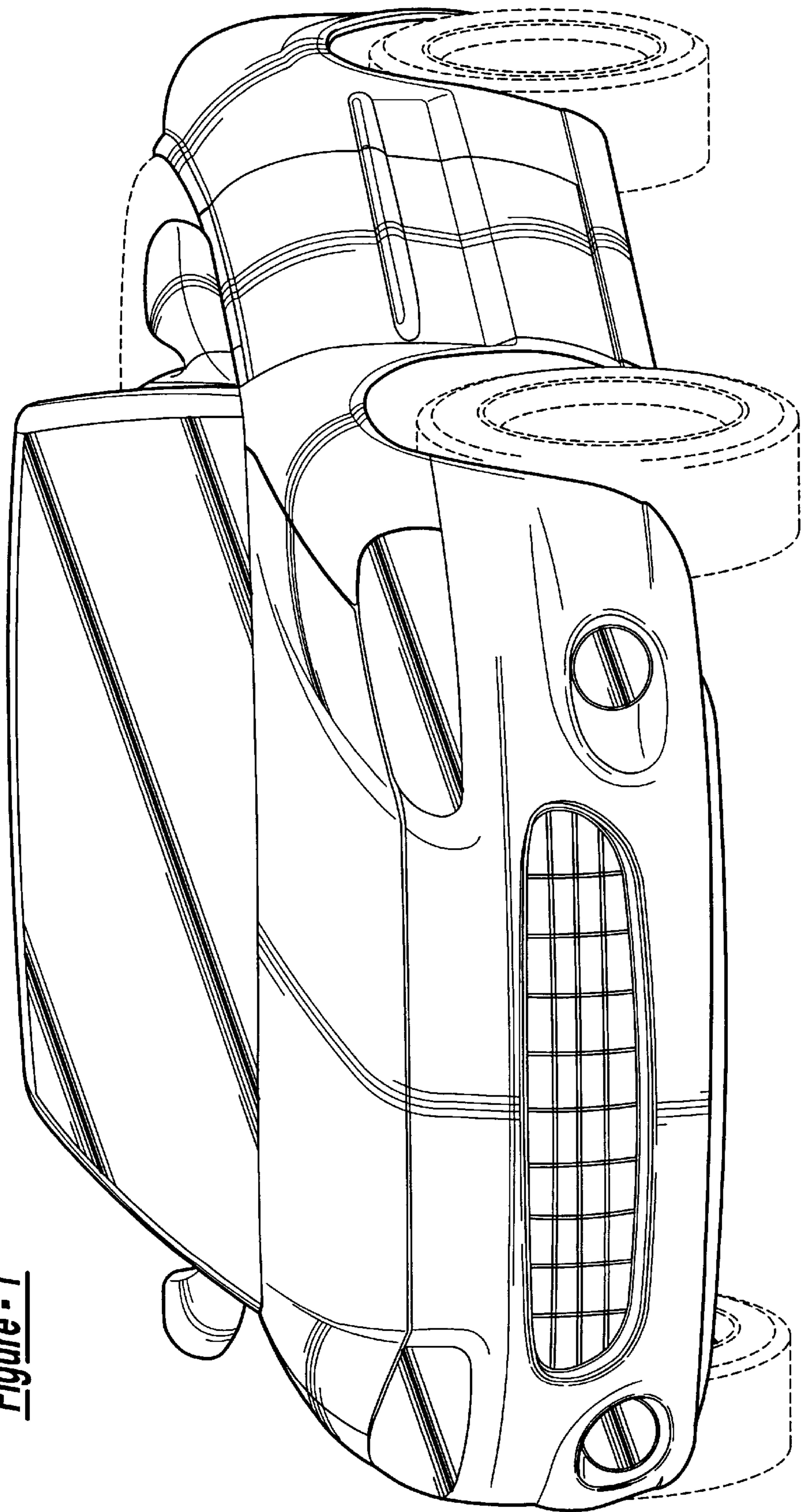

Figure - 1

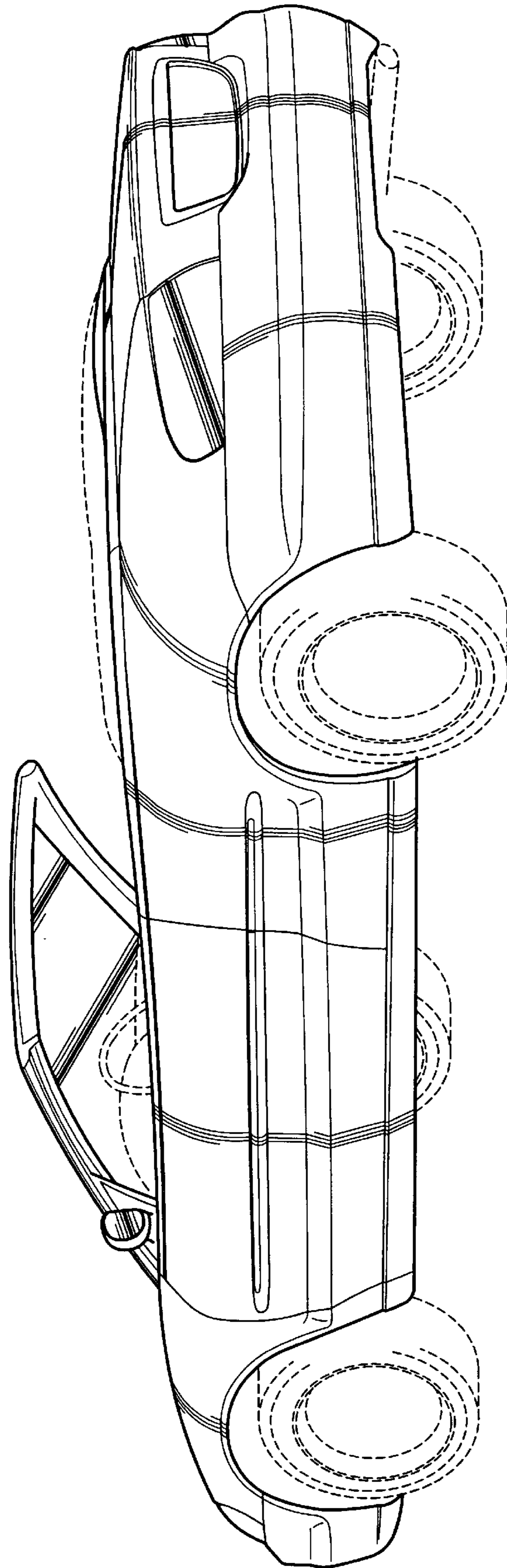

Figure - 2

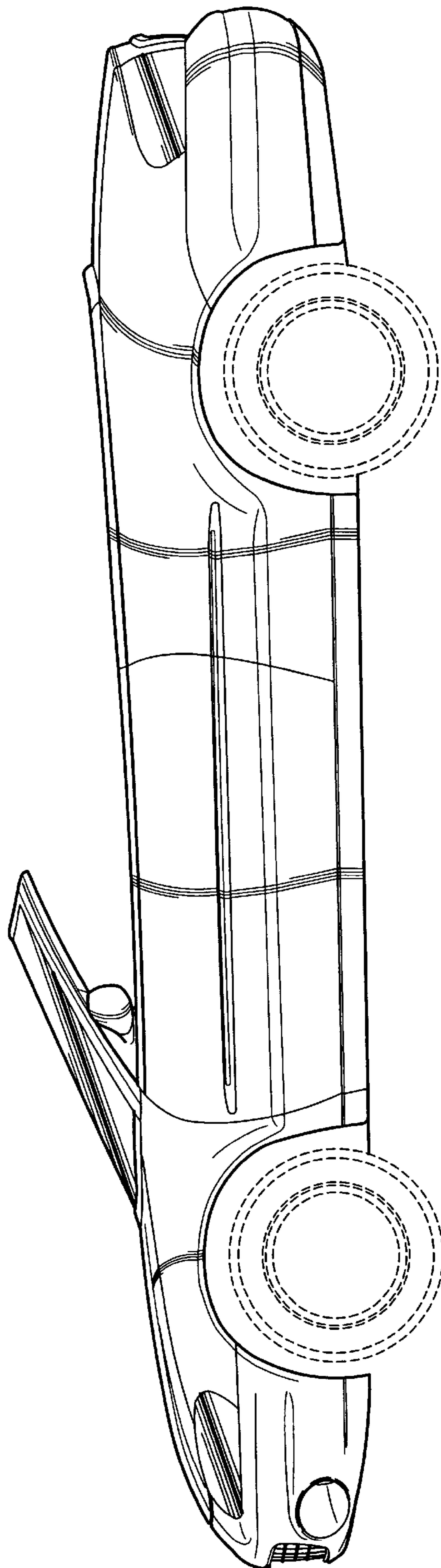

Figure - 3

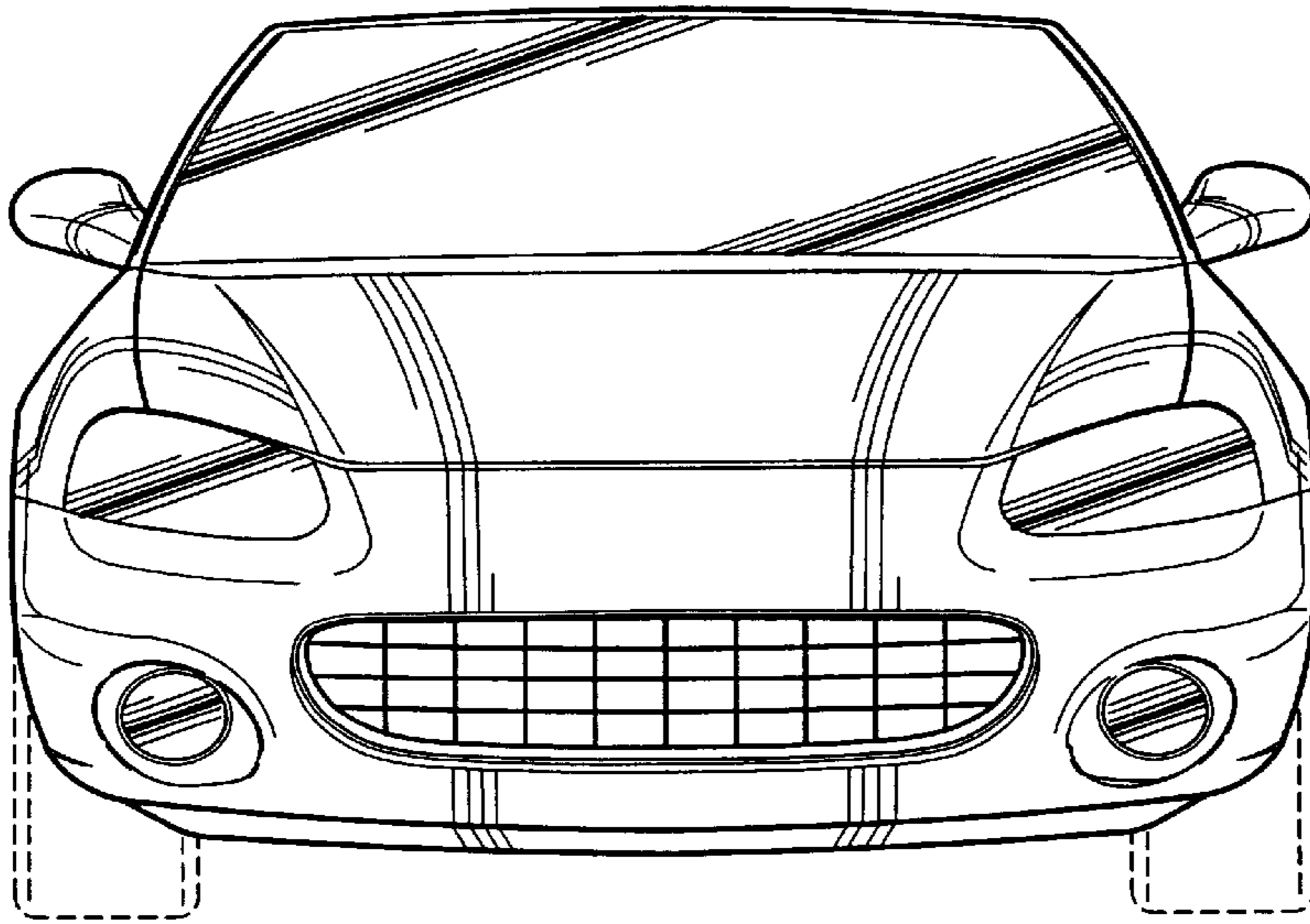

Figure - 4

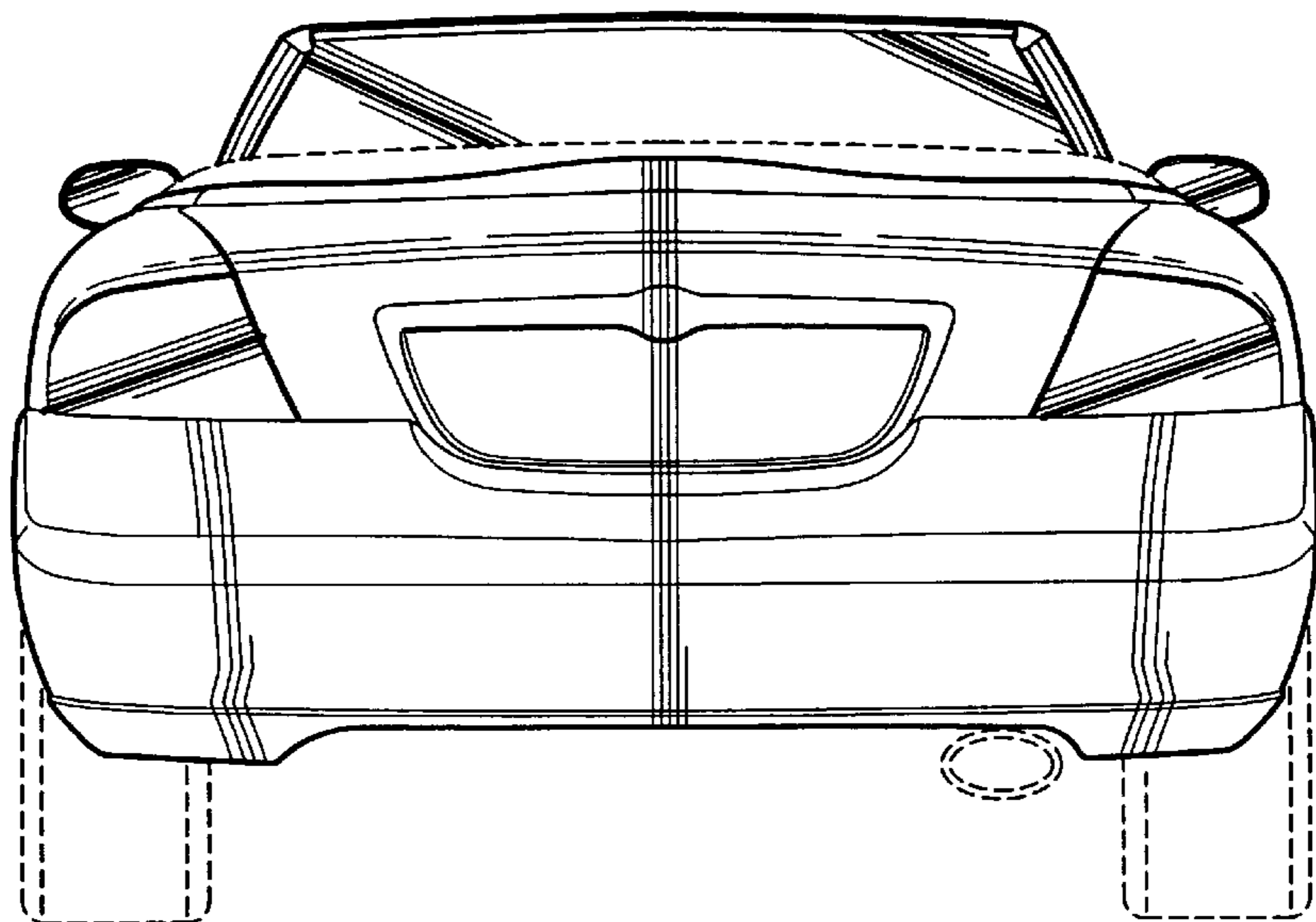

Figure - 5

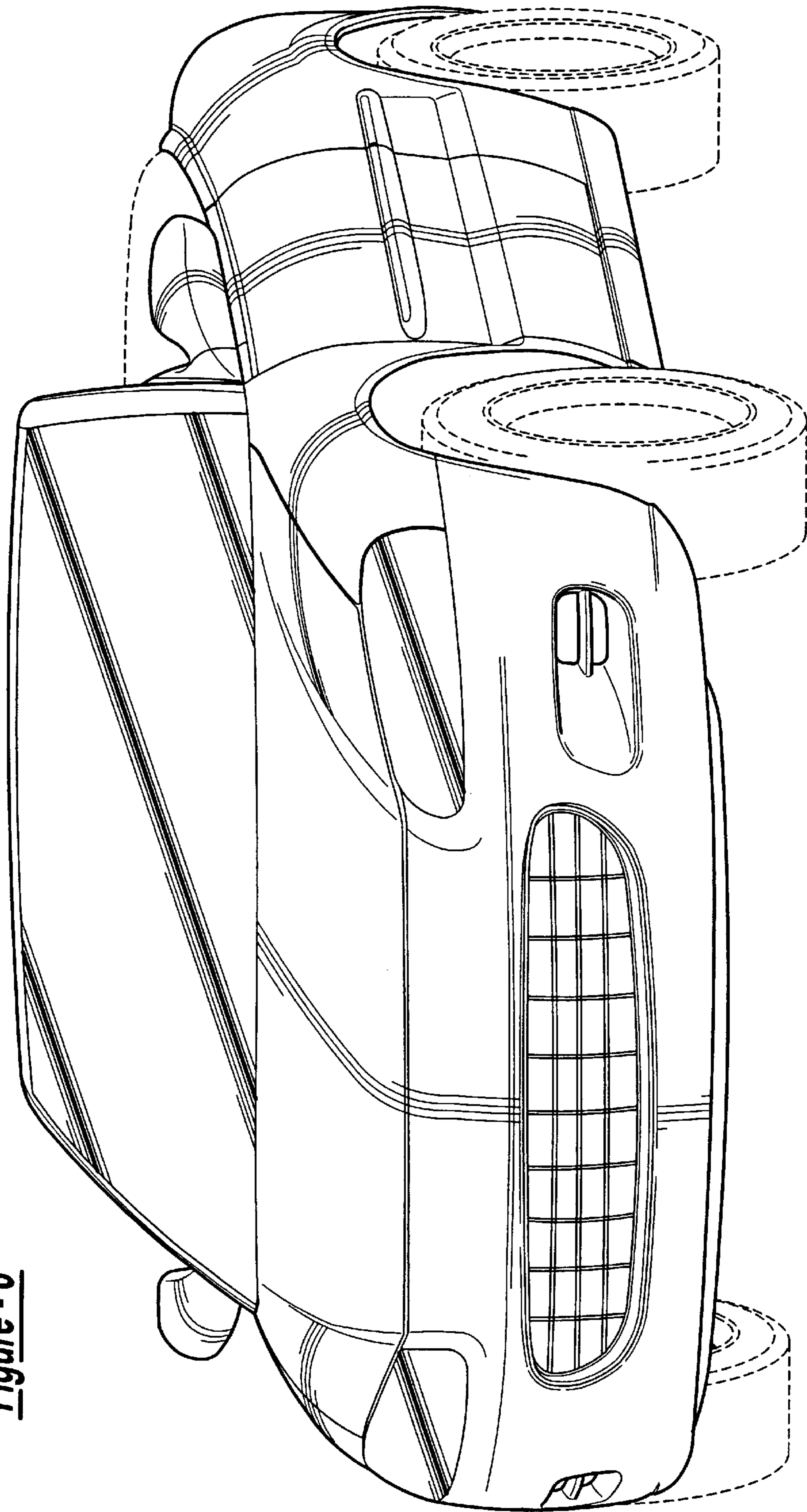

Figure - 6

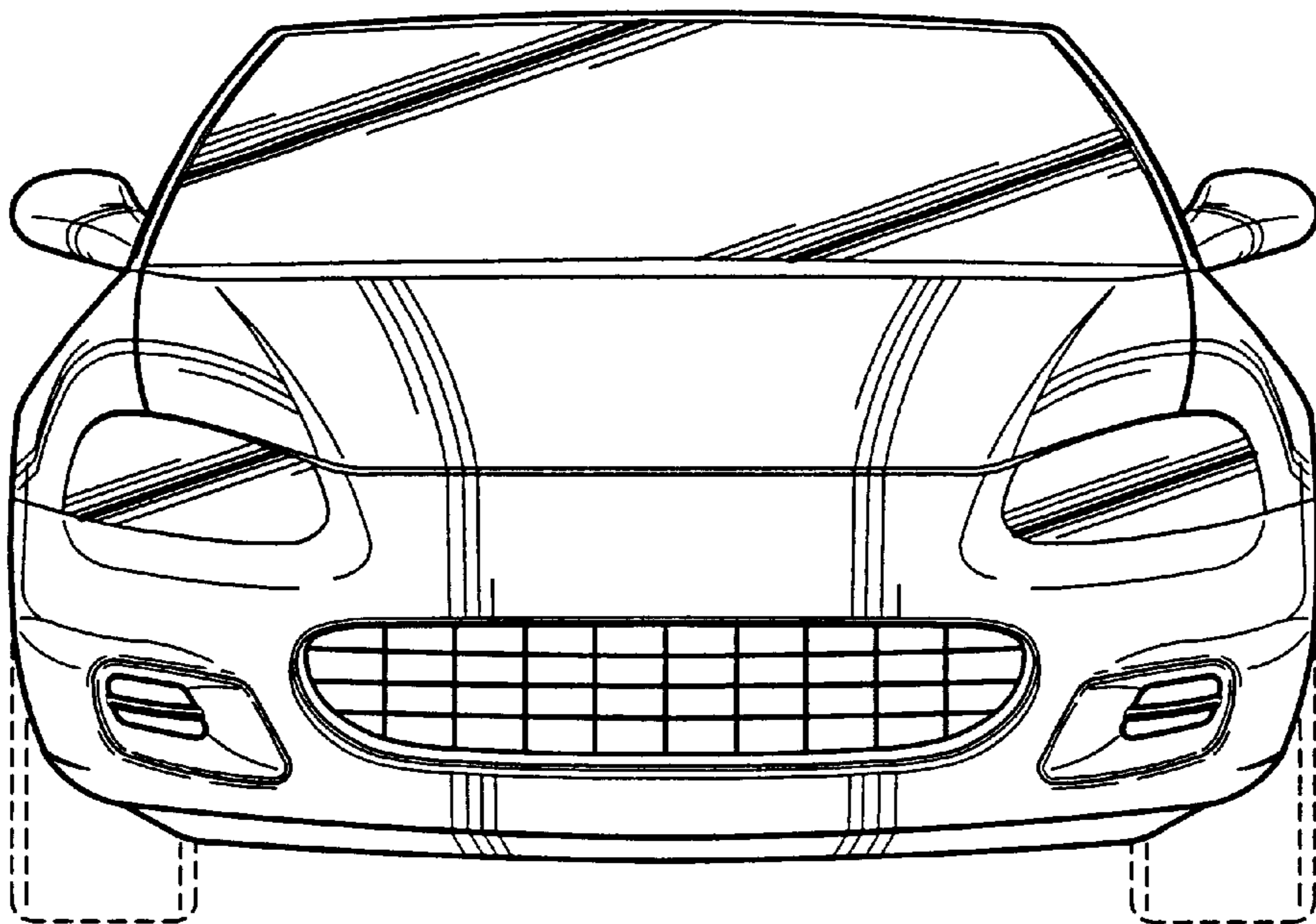

Figure - 7