



US00D440524S

(12) **United States Design Patent**
Robinson

(10) **Patent No.:** **US D440,524 S**

(45) **Date of Patent:** **** Apr. 17, 2001**

(54) **MOTIVATIONAL AND RELIGIOUS DEVICE AND AWARD**

Primary Examiner—Dominic Simone
(74) *Attorney, Agent, or Firm*—Woodard, Emhardt, Naughton, Moriarty & McNett

(76) **Inventor:** **Hewitt Robinson**, 1641 E. Broad Ripple Ave., Indianapolis, IN (US) 46204

(57) **CLAIM**

(**) **Term:** **14 Years**

The ornamental design for a motivational and religious device and award, as shown and described.

(21) **Appl. No.:** **29/122,898**

DESCRIPTION

(22) **Filed:** **May 5, 2000**

FIG. 1 is a perspective view of the motivational and religious device and award of the present invention.

(51) **LOC (7) Cl.** **11-02**

FIG. 2 is a front elevation.

(52) **U.S. Cl.** **D11/131**

FIG. 3 is a side elevation taken from the right side of FIG. 2. The opposite side elevation is the mirror image of FIG. 3.

(58) **Field of Search** D11/131, 157; D99/17, 24, 25, 99; 428/8, 10, 542.2–542.6

FIG. 4 is a rear elevation.

(56) **References Cited**

FIG. 5 is a top plan.

U.S. PATENT DOCUMENTS

FIG. 6 is a bottom plan; and,

D. 253,528 * 11/1979 Sun D11/131

FIG. 7 is a vertical taken in the direction of the arrows 7—7 in FIG. 5.

D. 320,177 * 9/1991 Meekins et al. D11/157

D. 369,572 * 5/1996 Buck et al. D11/131

5,506,010 * 4/1996 Buck et al. 428/14

* cited by examiner

1 Claim, 7 Drawing Sheets

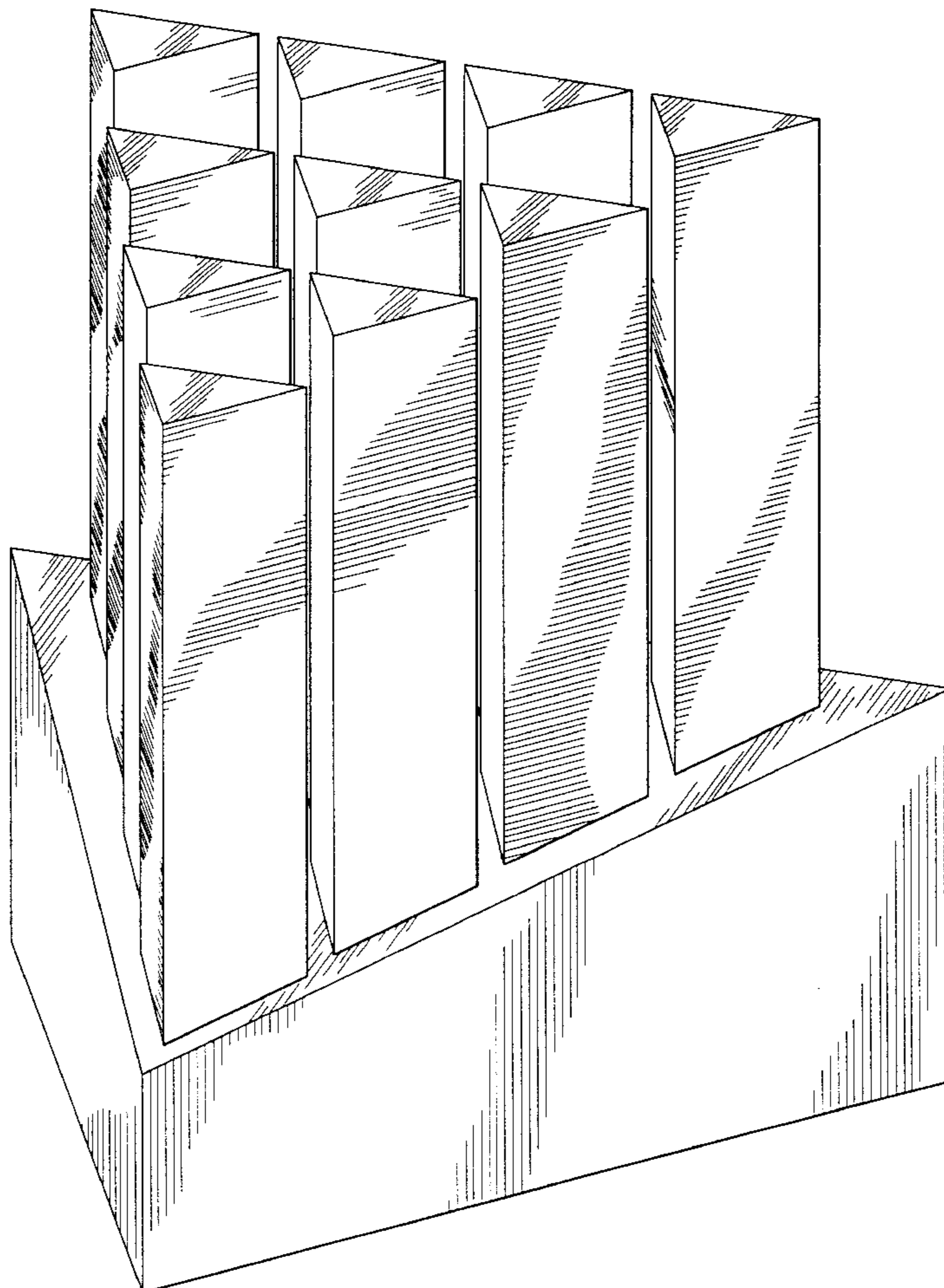

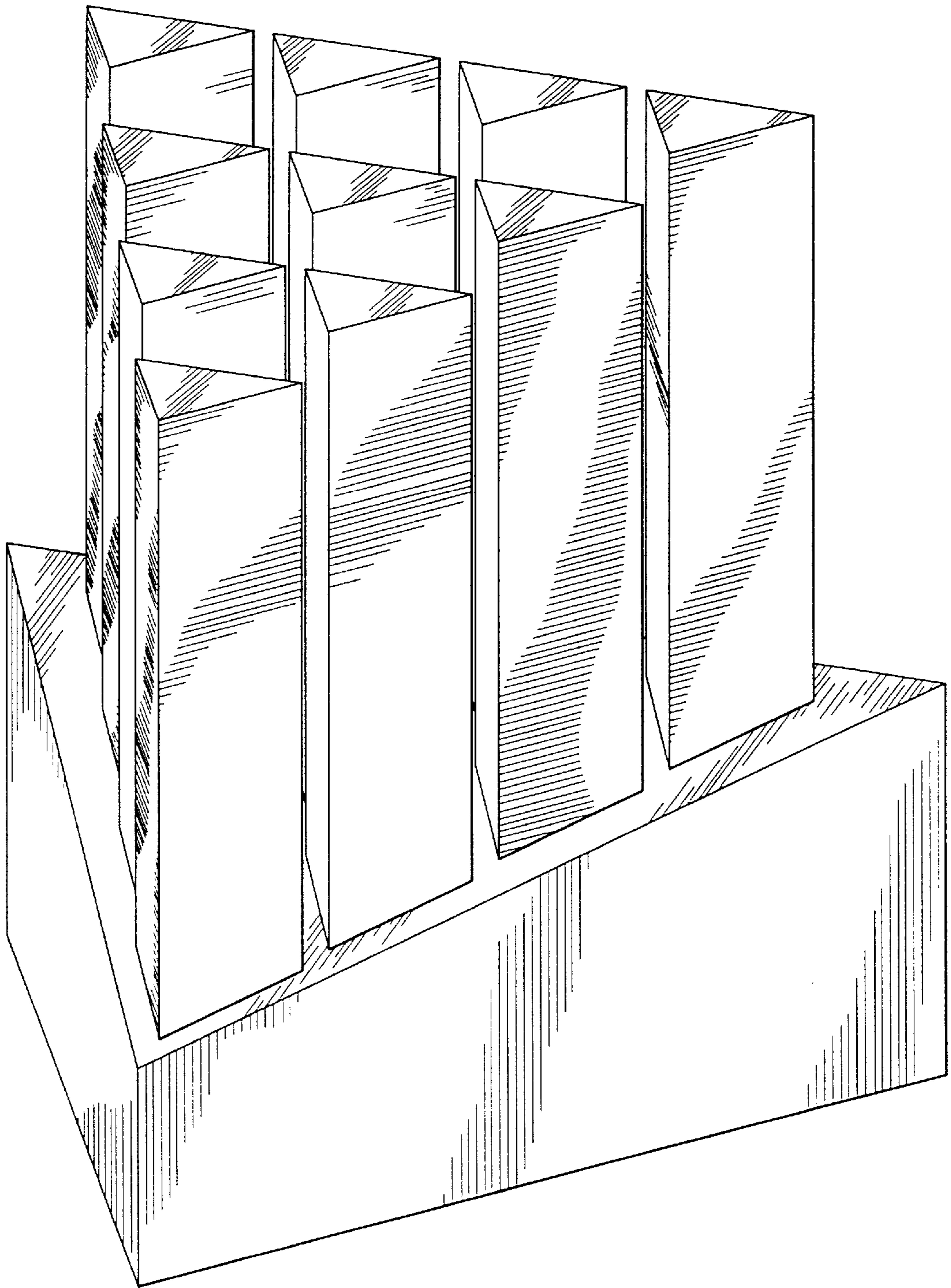

Fig. 1

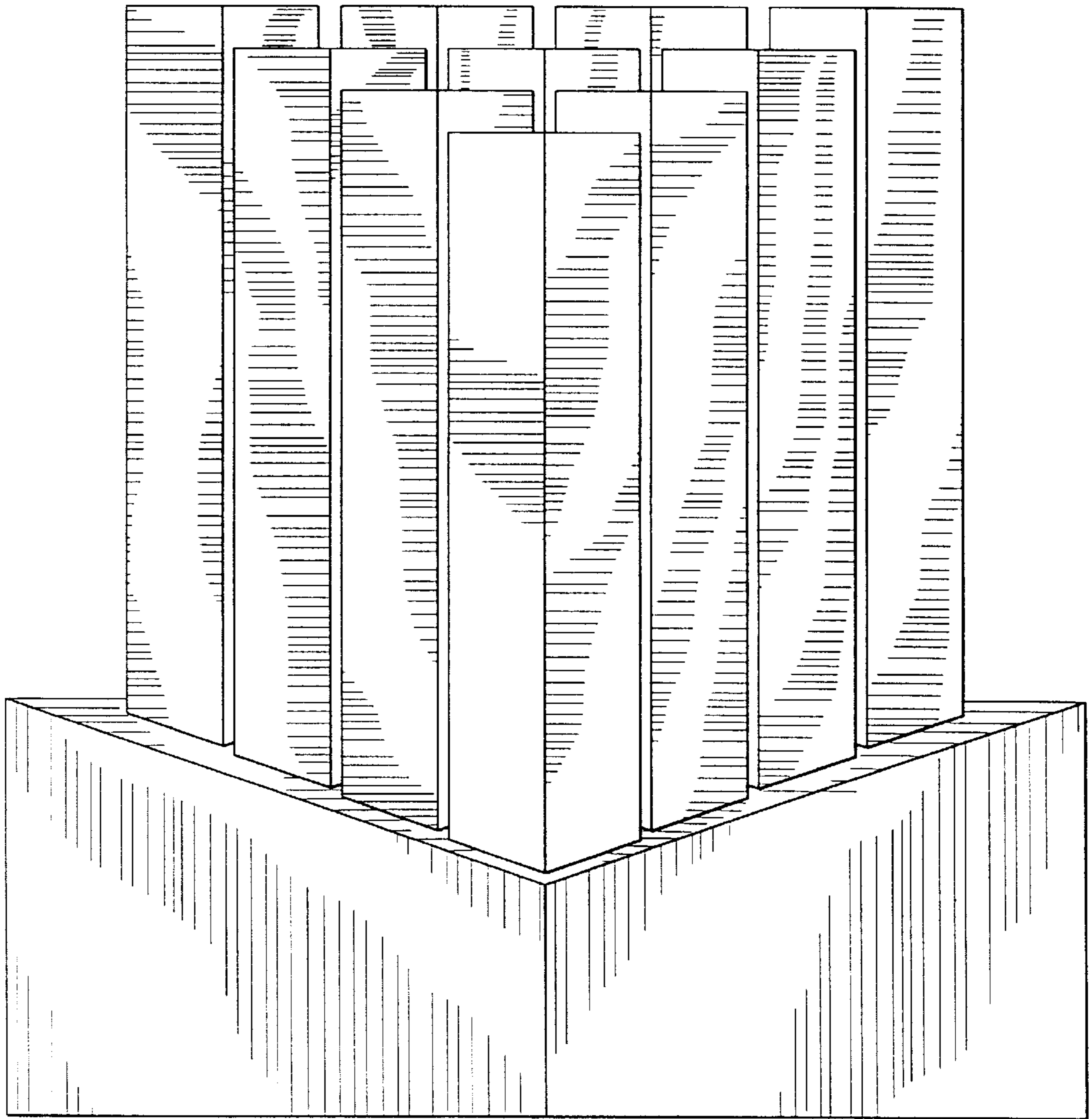

Fig. 2

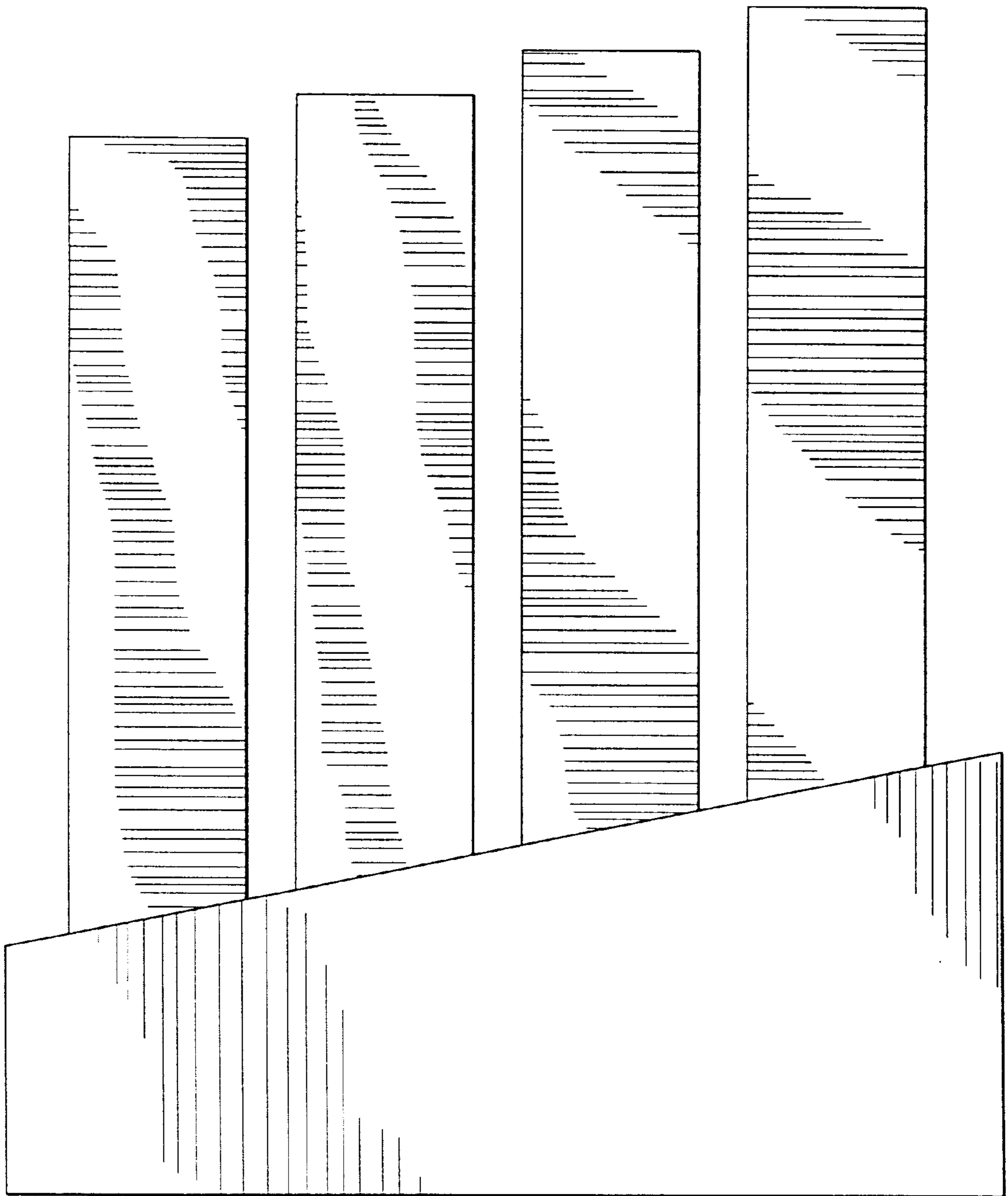

Fig. 3

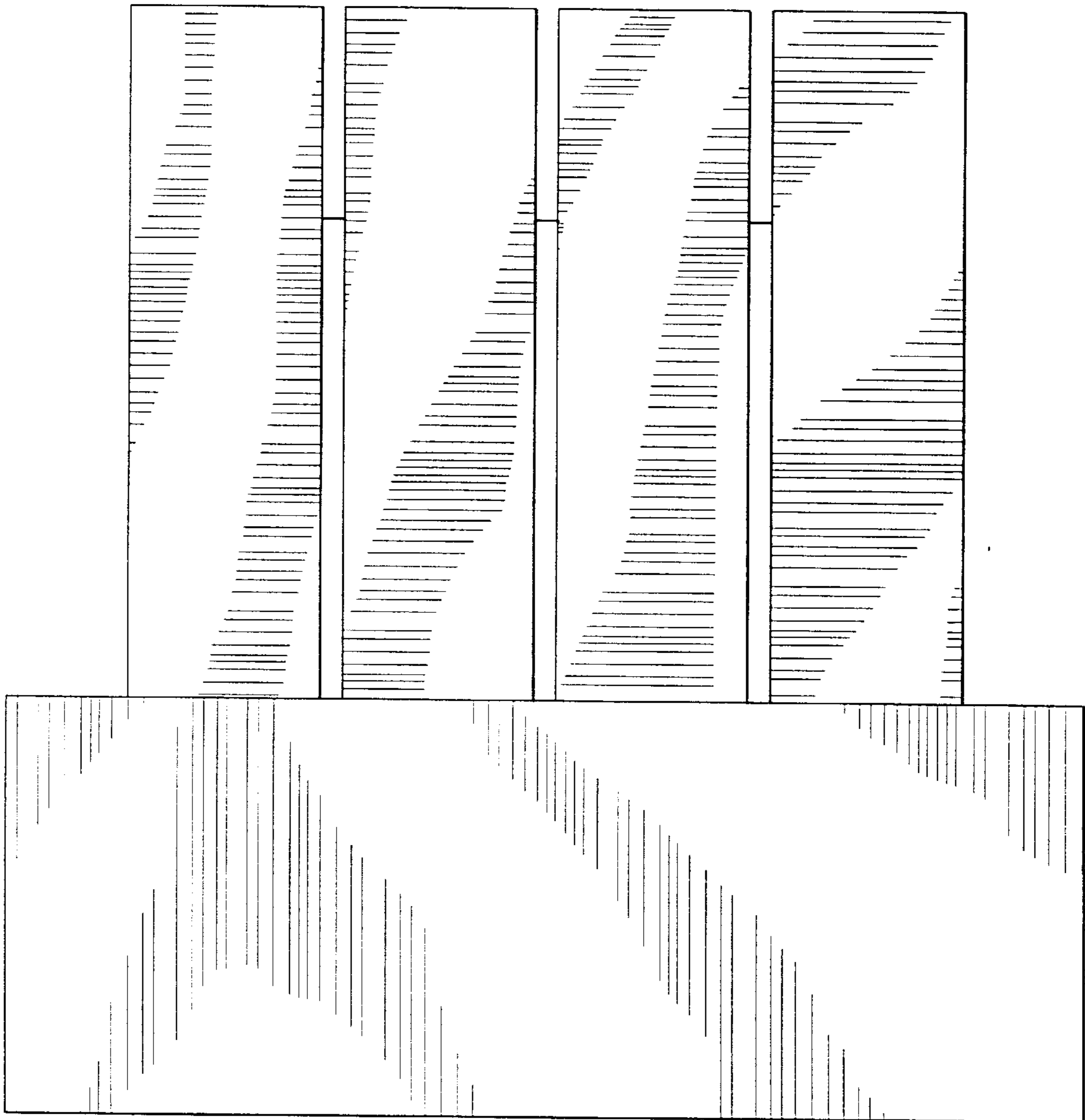

Fig. 4

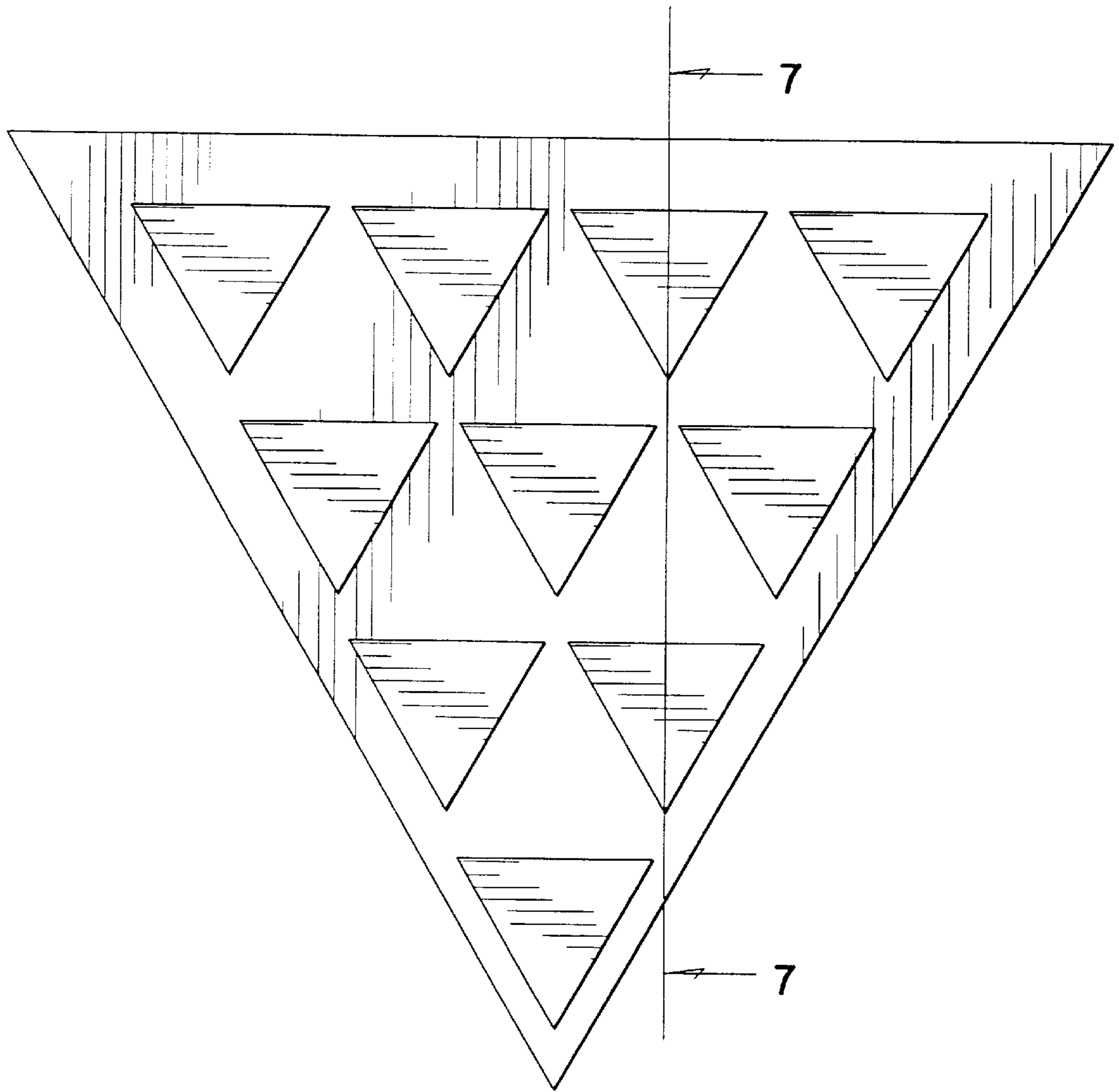

Fig. 5

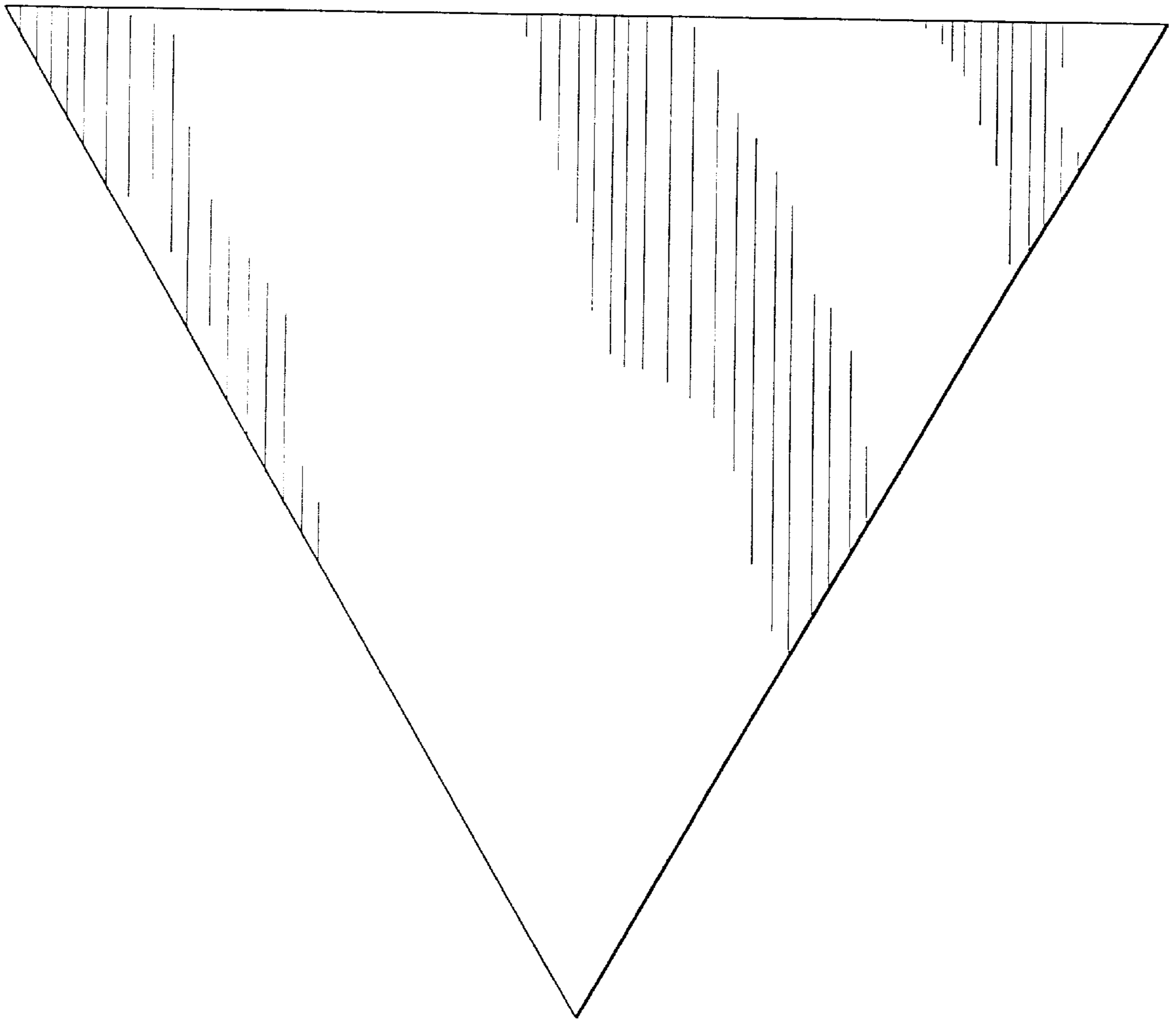

Fig. 6

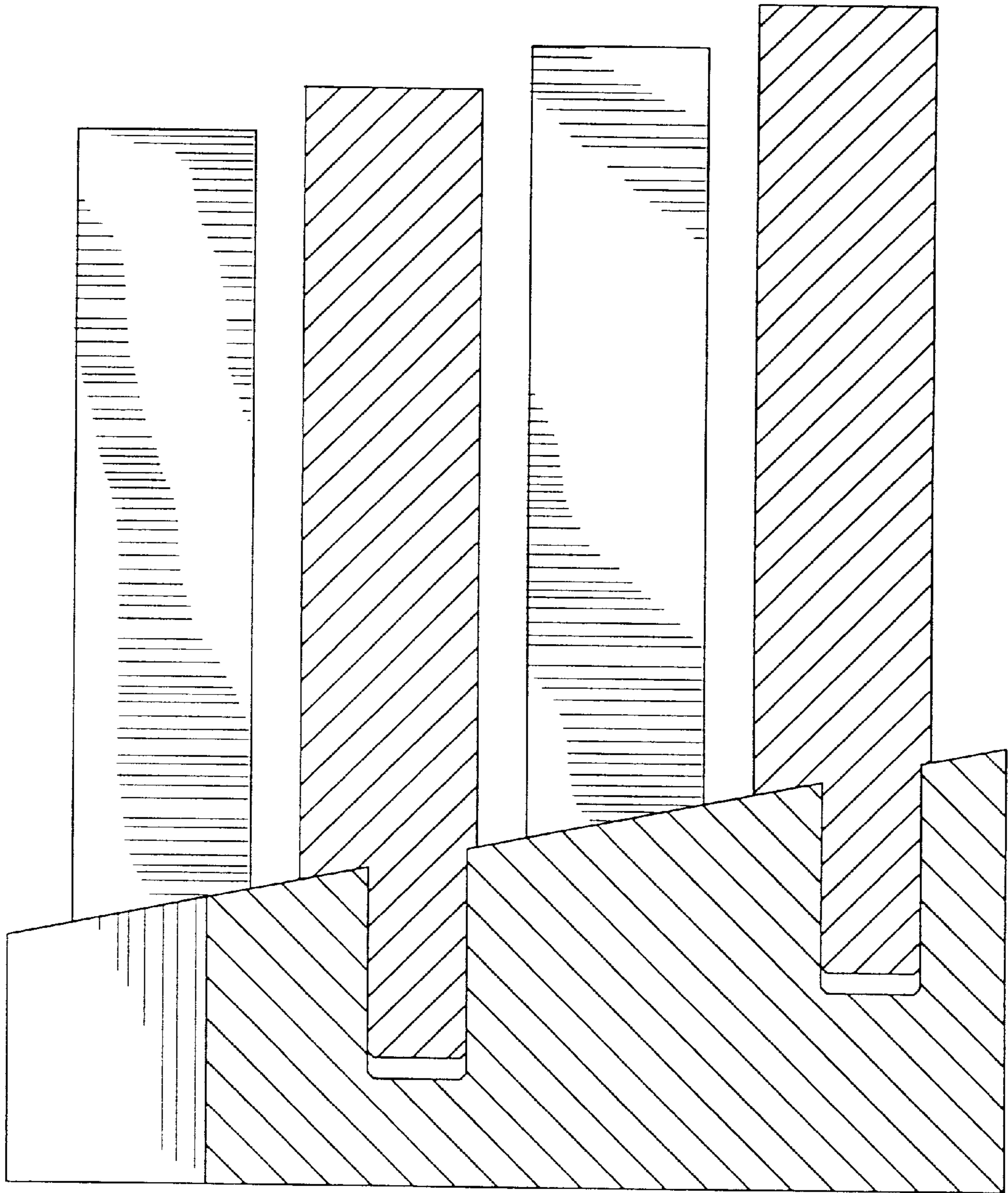

Fig. 7