



US00D440422S

(12) **United States Design Patent**
DeJule

(10) **Patent No.:** **US D440,422 S**

(45) **Date of Patent:** **** Apr. 17, 2001**

(54) **SEATING SYSTEM**

(75) Inventor: **Aaron M. DeJule, Jr.** Chicago, IL (US)

(73) Assignee: **Krueger International, Inc.**, Green Bay, WI (US)

(*) Notice: This patent is subject to a terminal disclaimer.

(**) Term: **14 Years**

(21) Appl. No.: **29/093,104**

(22) Filed: **Sep. 3, 1998**

Related U.S. Application Data

(63) Continuation-in-part of application No. 29/068,221, filed on Mar. 20, 1997, now Pat. No. Des. 412,622.

(51) **LOC (7) Cl.** **06-01**

(52) **U.S. Cl.** **D6/371; D6/381**

(58) **Field of Search** D6/334, 335, 336, D6/368, 371, 373, 374, 379, 380, 381, 500, 501, 502; 297/232, 248

(56) **References Cited**

U.S. PATENT DOCUMENTS

D. 228,104	*	8/1973	Blodee	D6/368
D. 253,859	*	1/1980	Hosoe	D6/381 X
D. 339,940		10/1993	Balderi et al.	D6/502
D. 347,330	*	5/1994	Kinsman	D6/334
D. 347,947	*	6/1994	Donnelly	D6/368
D. 412,622	*	8/1999	DeJule	D6/371
5,292,177		3/1994	Balderi et al.	297/232

* cited by examiner

Primary Examiner—Gary D. Watson

(74) *Attorney, Agent, or Firm*—Andrus, Scales, Starke & Sawall, LLP

(57) **CLAIM**

The ornamental design for a seating system, as shown and described.

DESCRIPTION

FIG. 1 is a perspective view of a seating system incorporating my new design, wherein the middle seat has been broken away to indicate an indeterminate number of seats. The opposite end which has not been shown is a mirror image of the side shown.

FIG. 2 is a front elevation view thereof;

FIG. 3 is a rear elevation view thereof;

FIG. 4 is a top plan view thereof;

FIG. 5 is a bottom plan view thereof;

FIG. 6 is a perspective view of a seating system incorporating a second embodiment of my new design, wherein the end units have been shown broken away to indicate an indeterminate width for the seating units and the middle unit has been shown broken away to indicate an indeterminate number of seats. The opposite end which has not been shown is a mirror image of the side shown.

FIG. 7 is a front elevation view thereof;

FIG. 8 is a rear elevation view thereof;

FIG. 9 is a top plan view thereof; and,

FIG. 10 is a bottom plan view thereof.

The inner portions of the armrest members which have not been shown are mirror images of the outer portions.

1 Claim, 10 Drawing Sheets

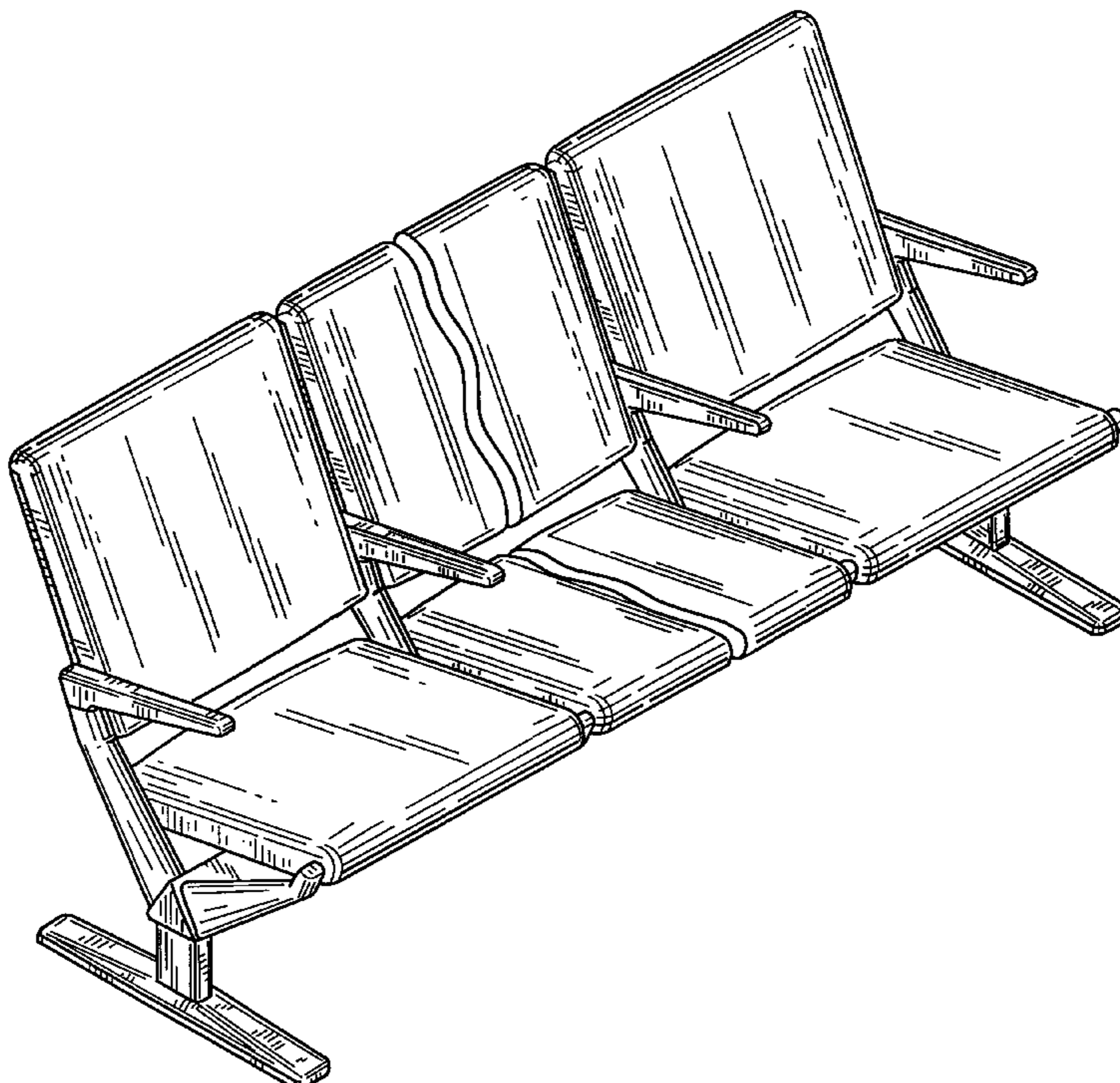

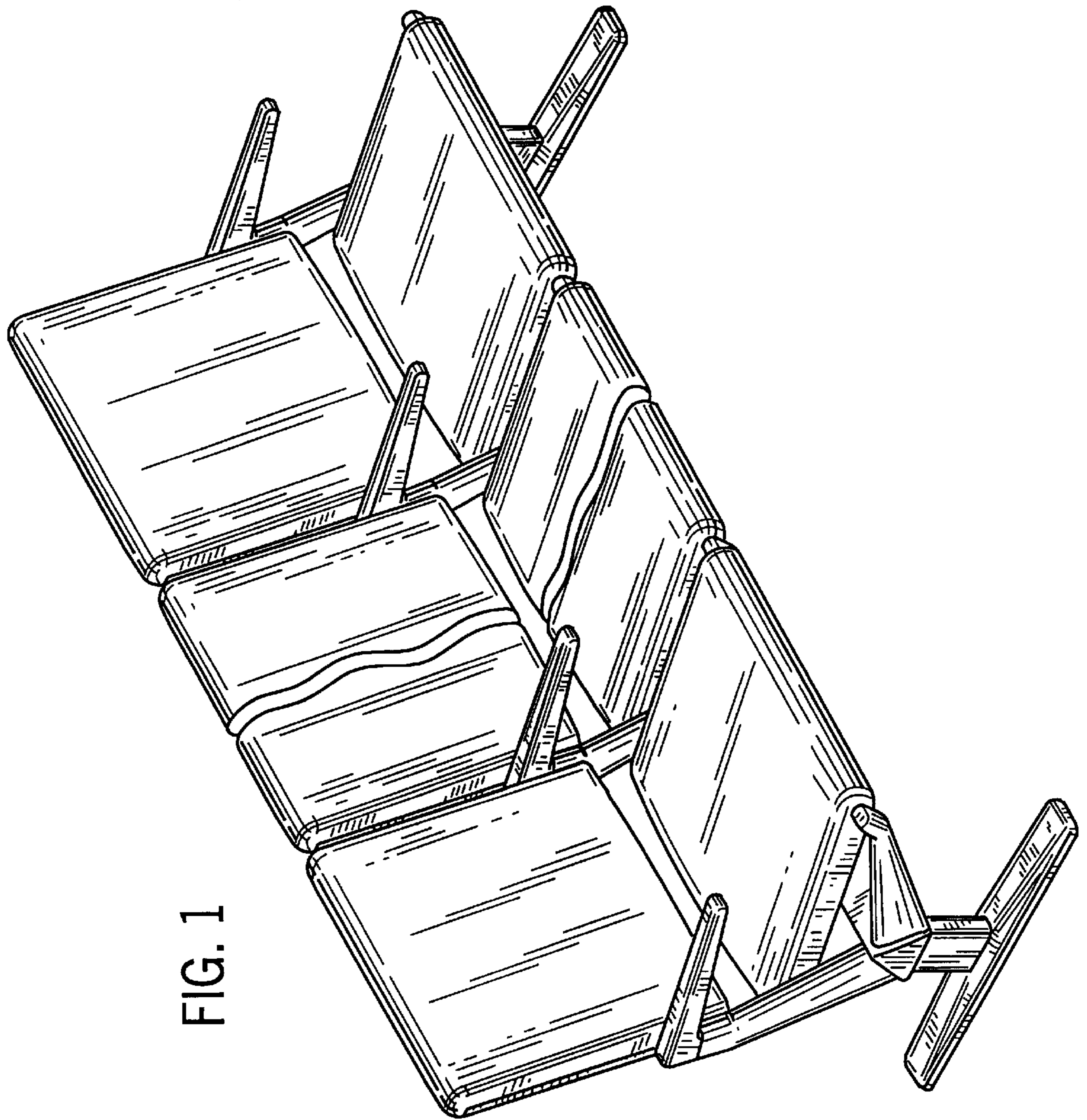

FIG. 1

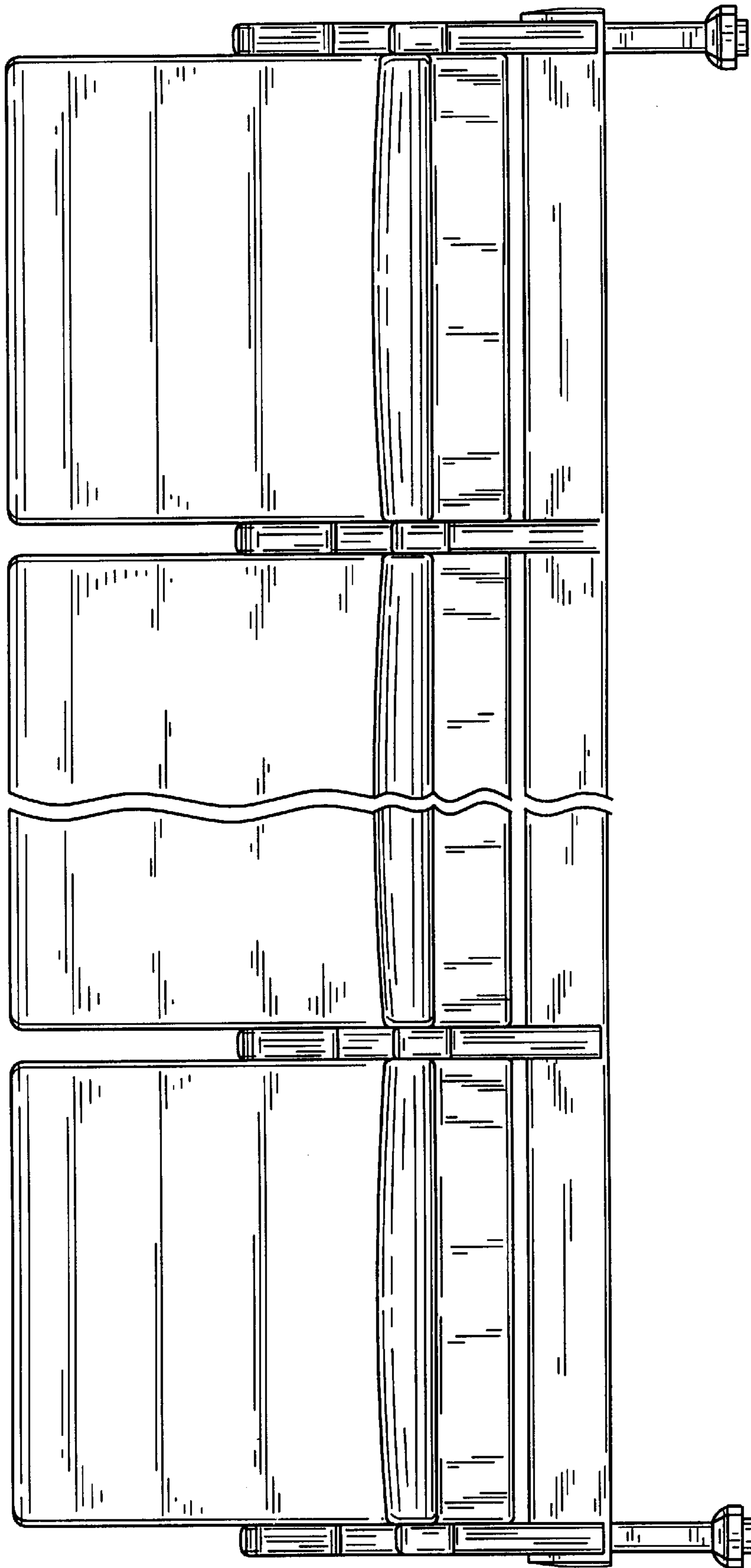

FIG. 2

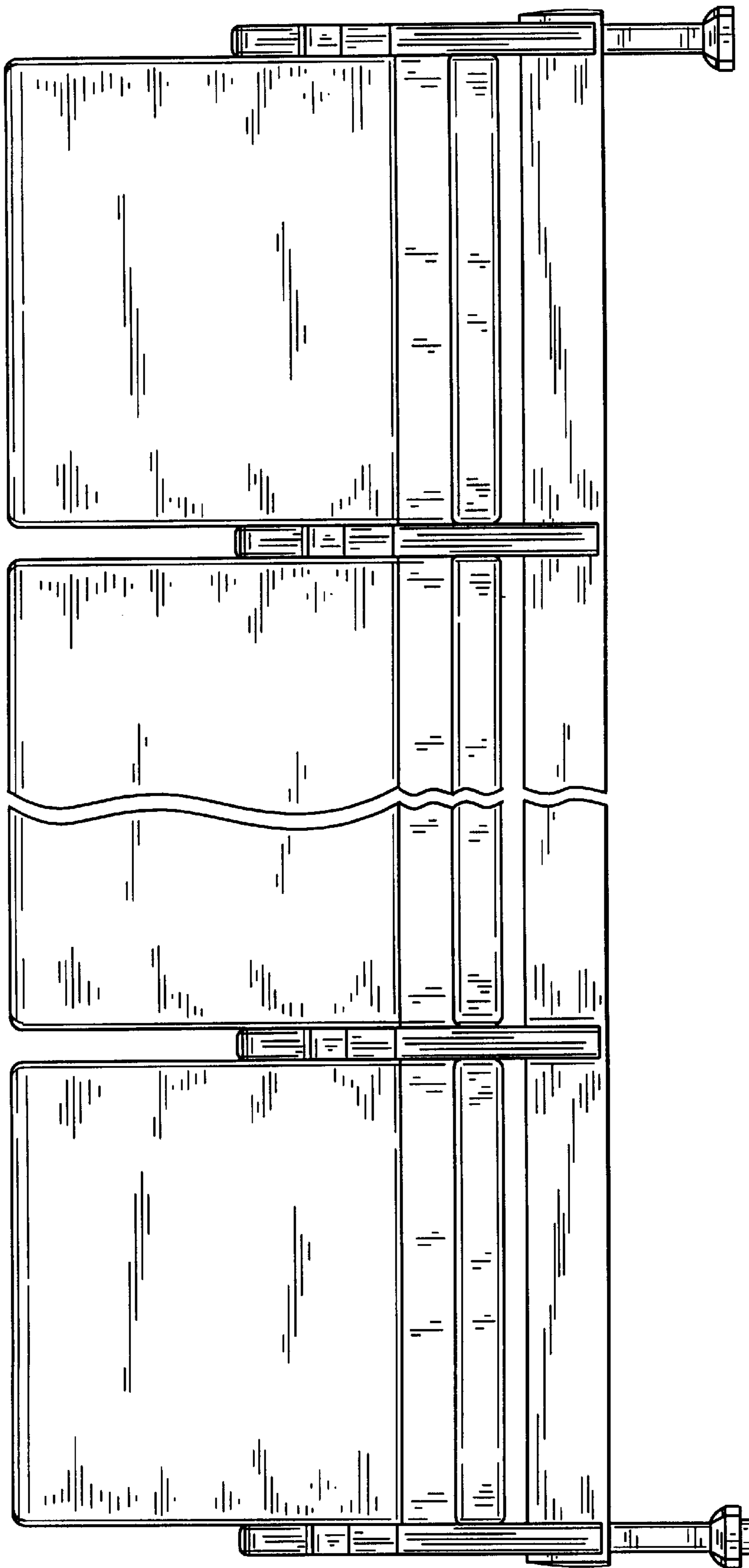

FIG. 3

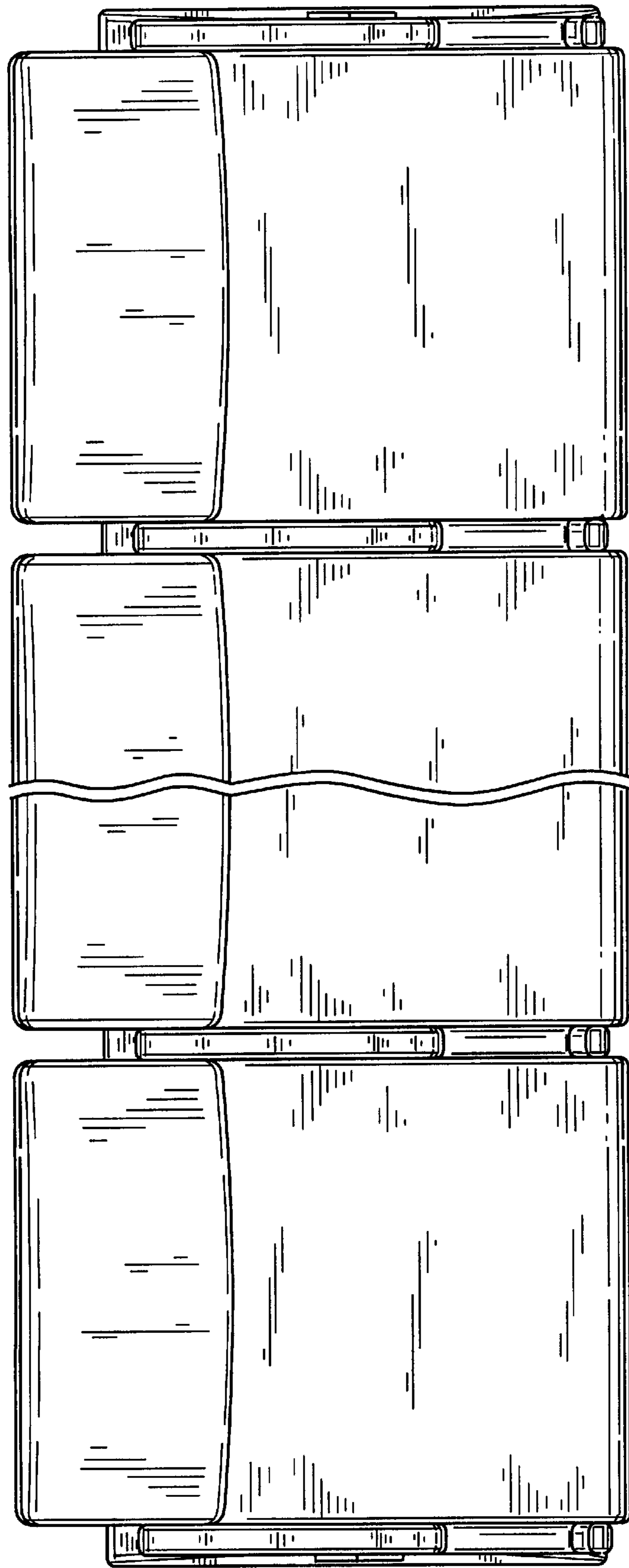

FIG. 4

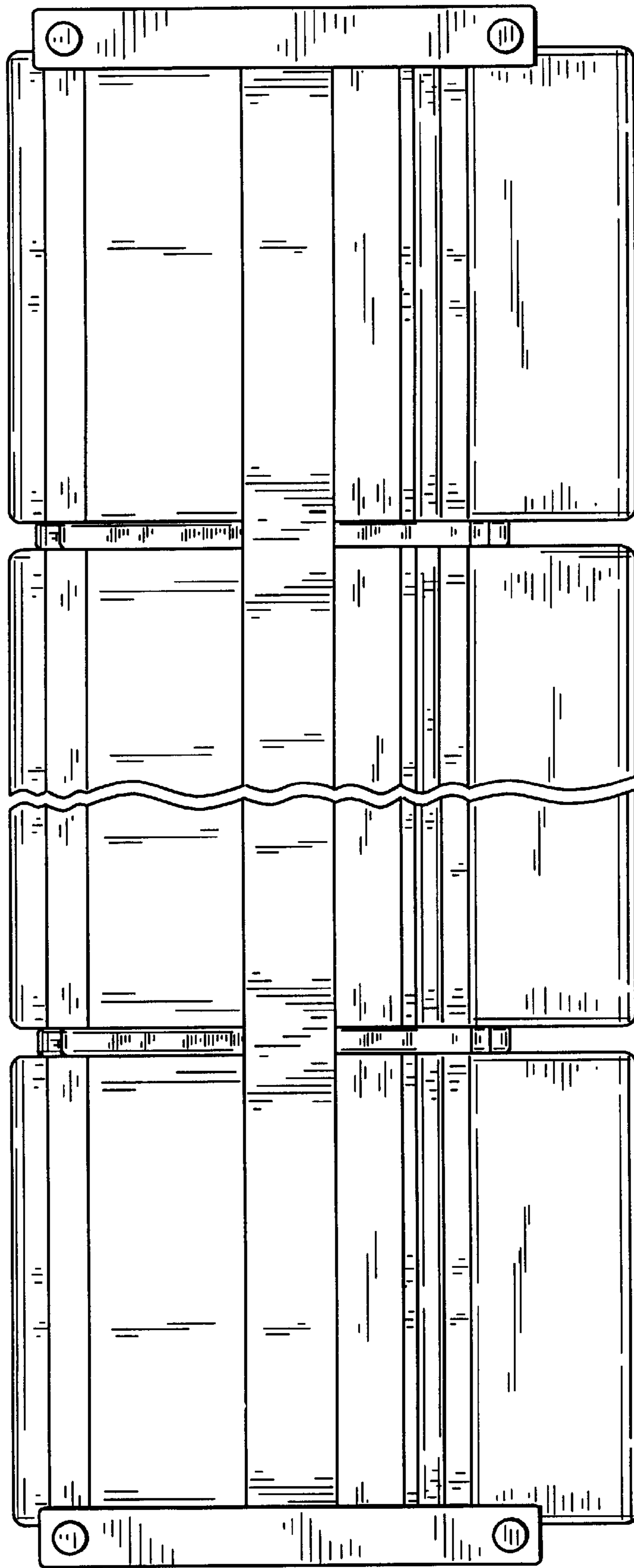
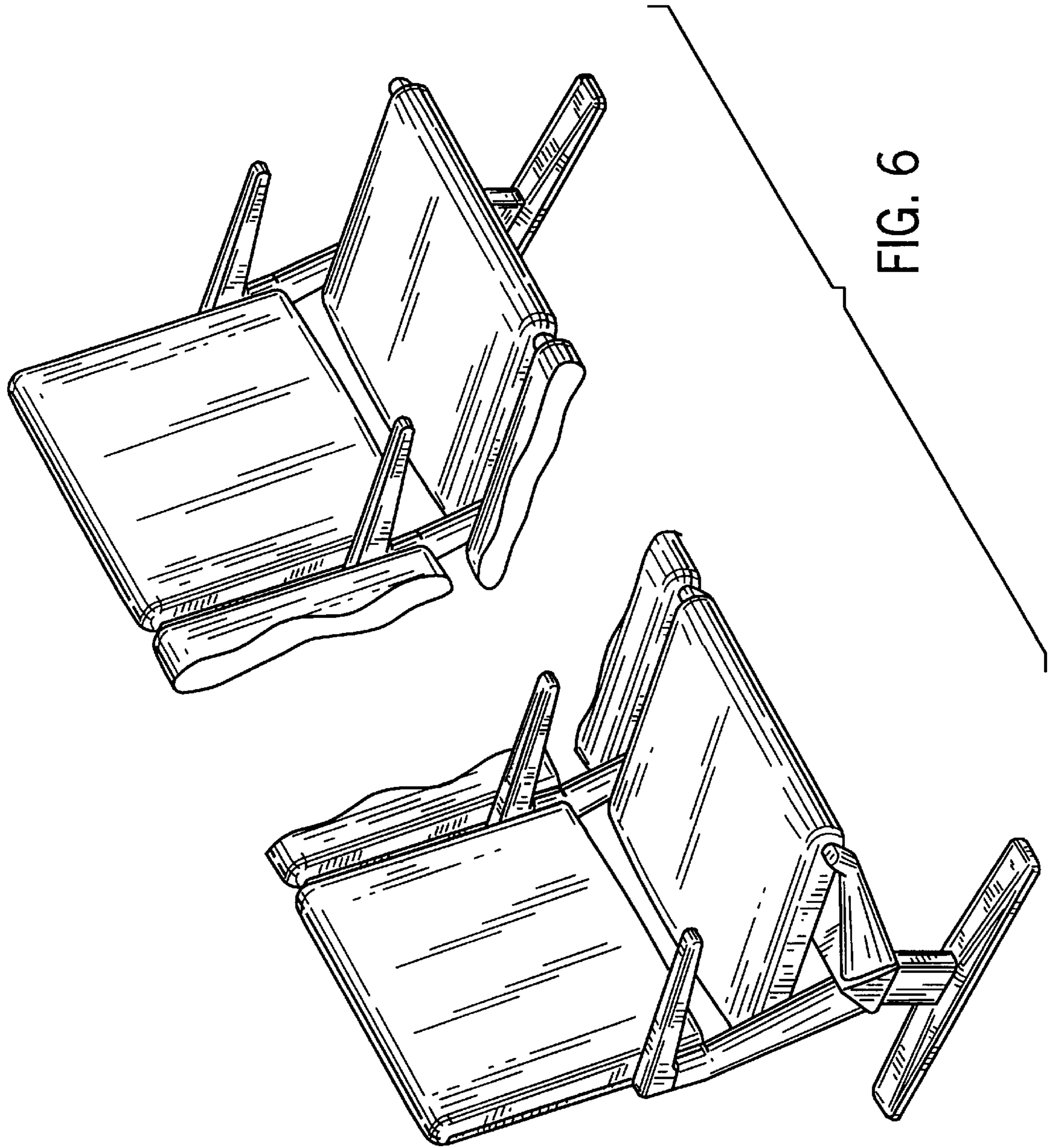

FIG. 5



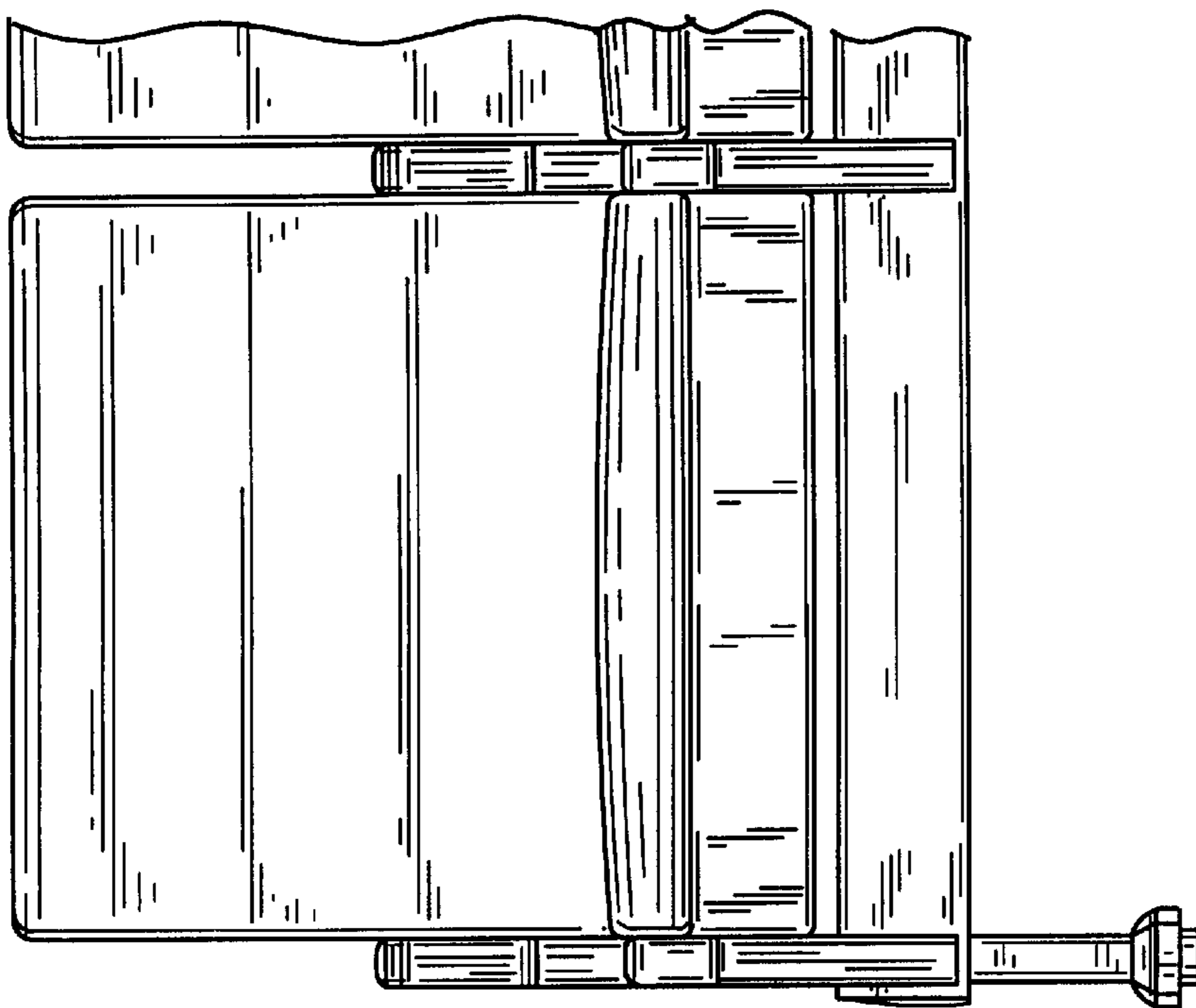
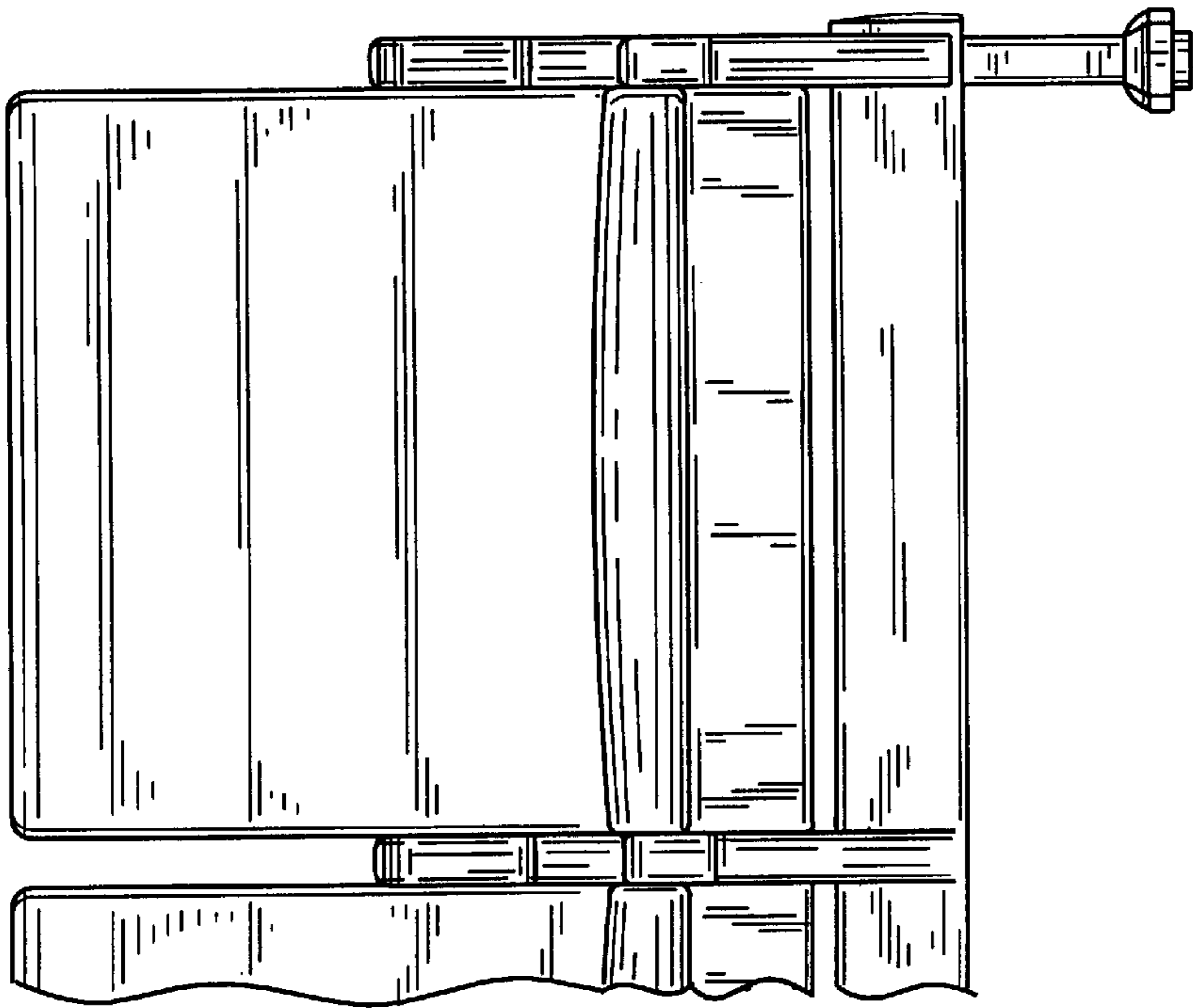

FIG. 7

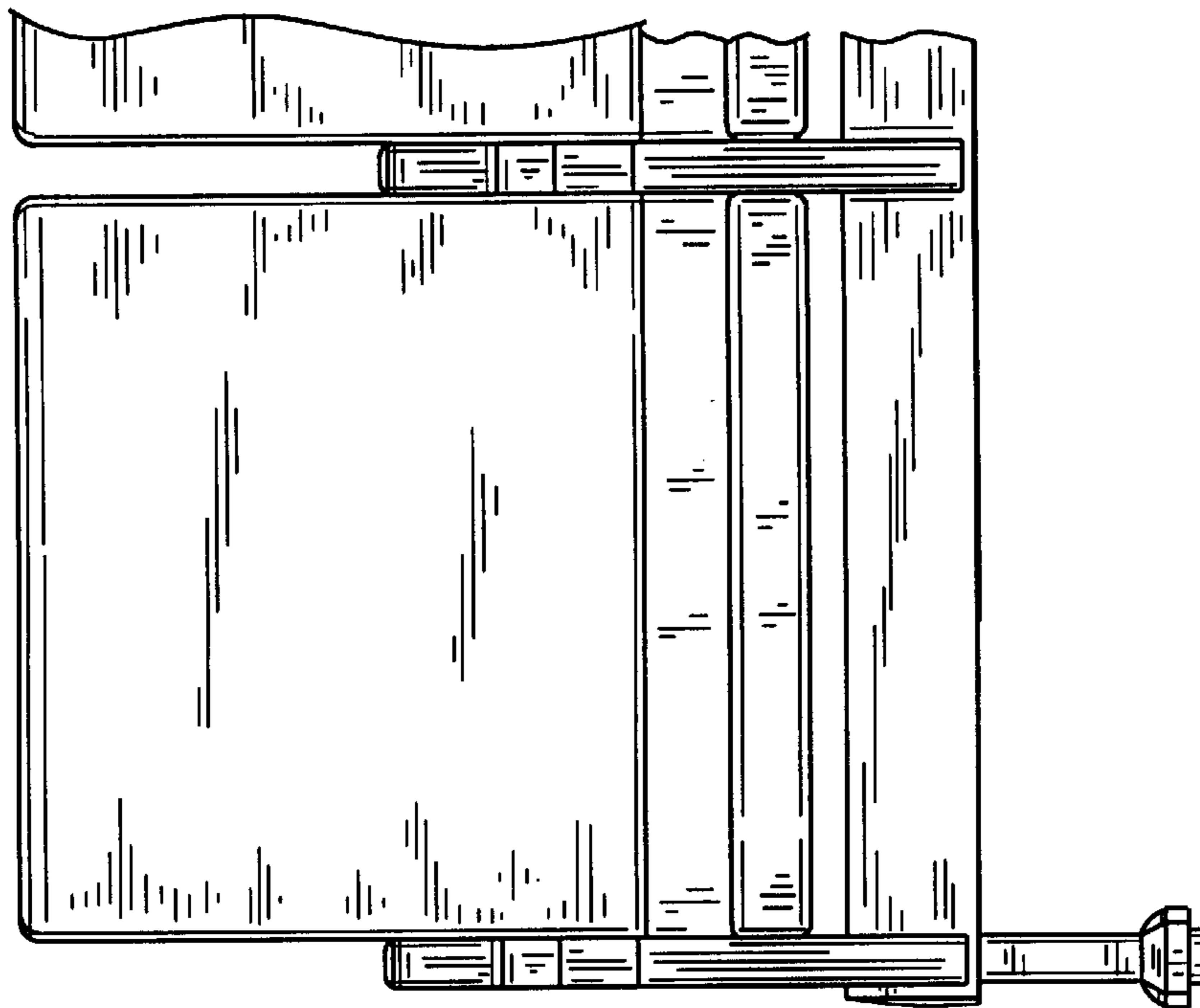
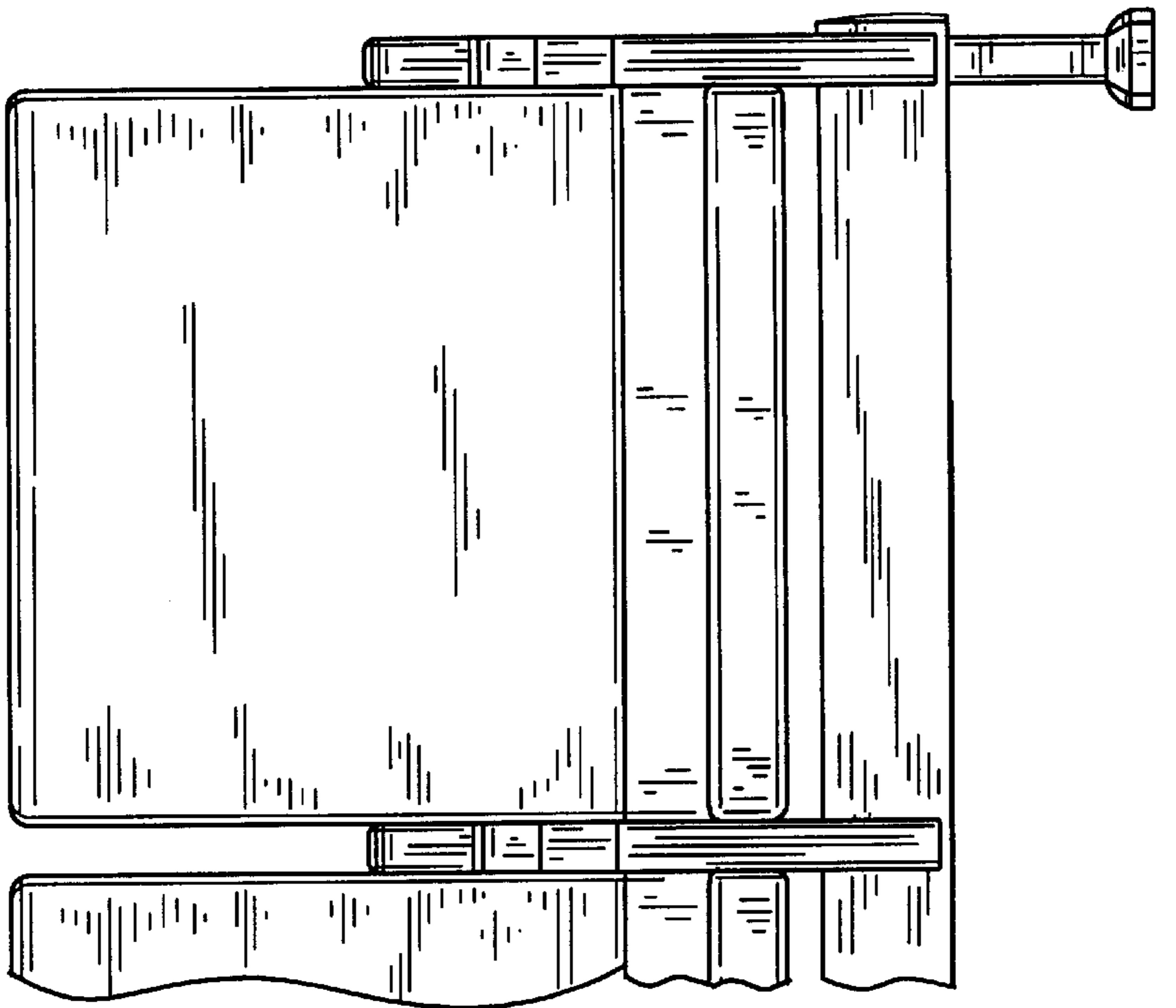

FIG. 8

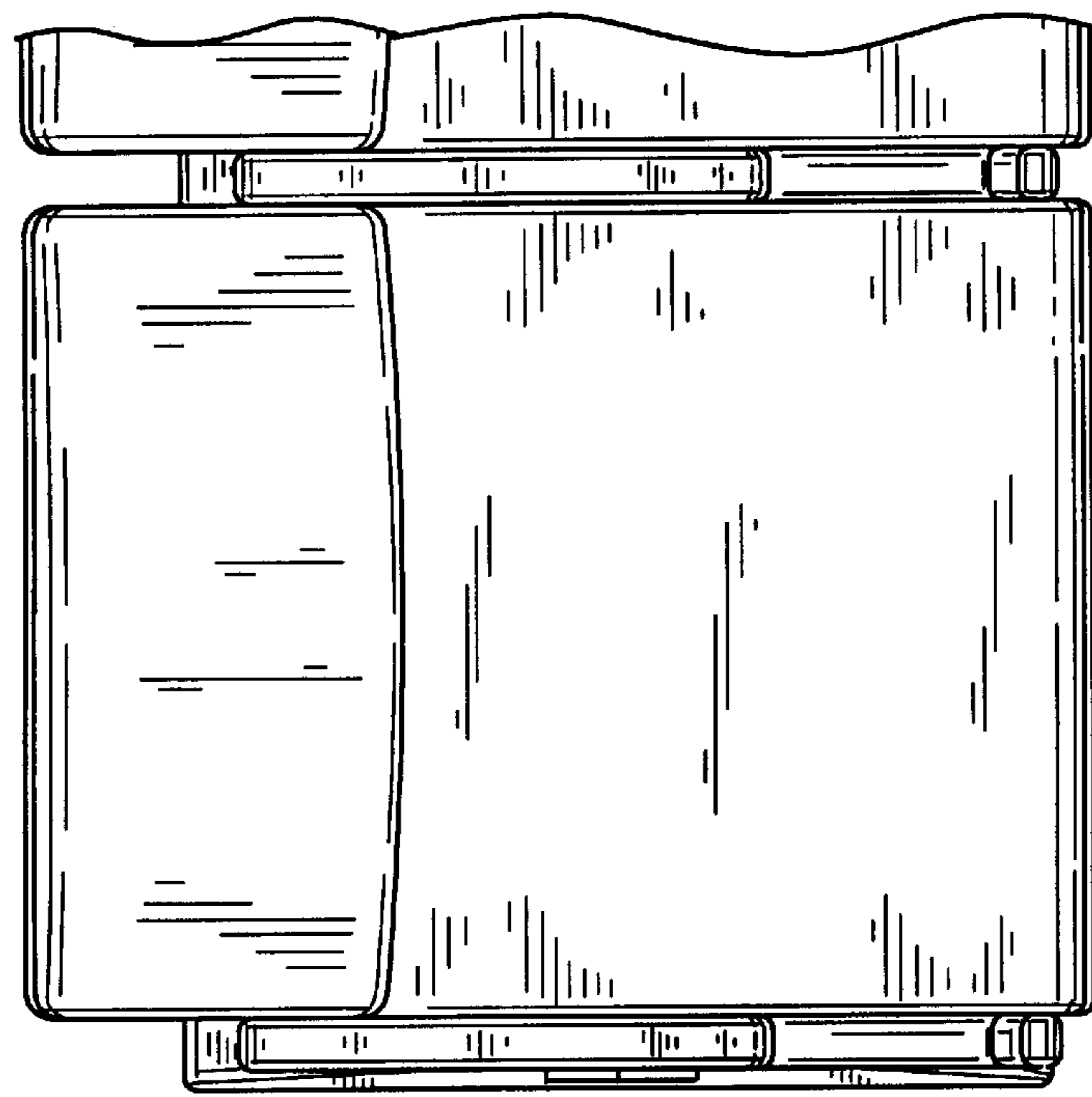
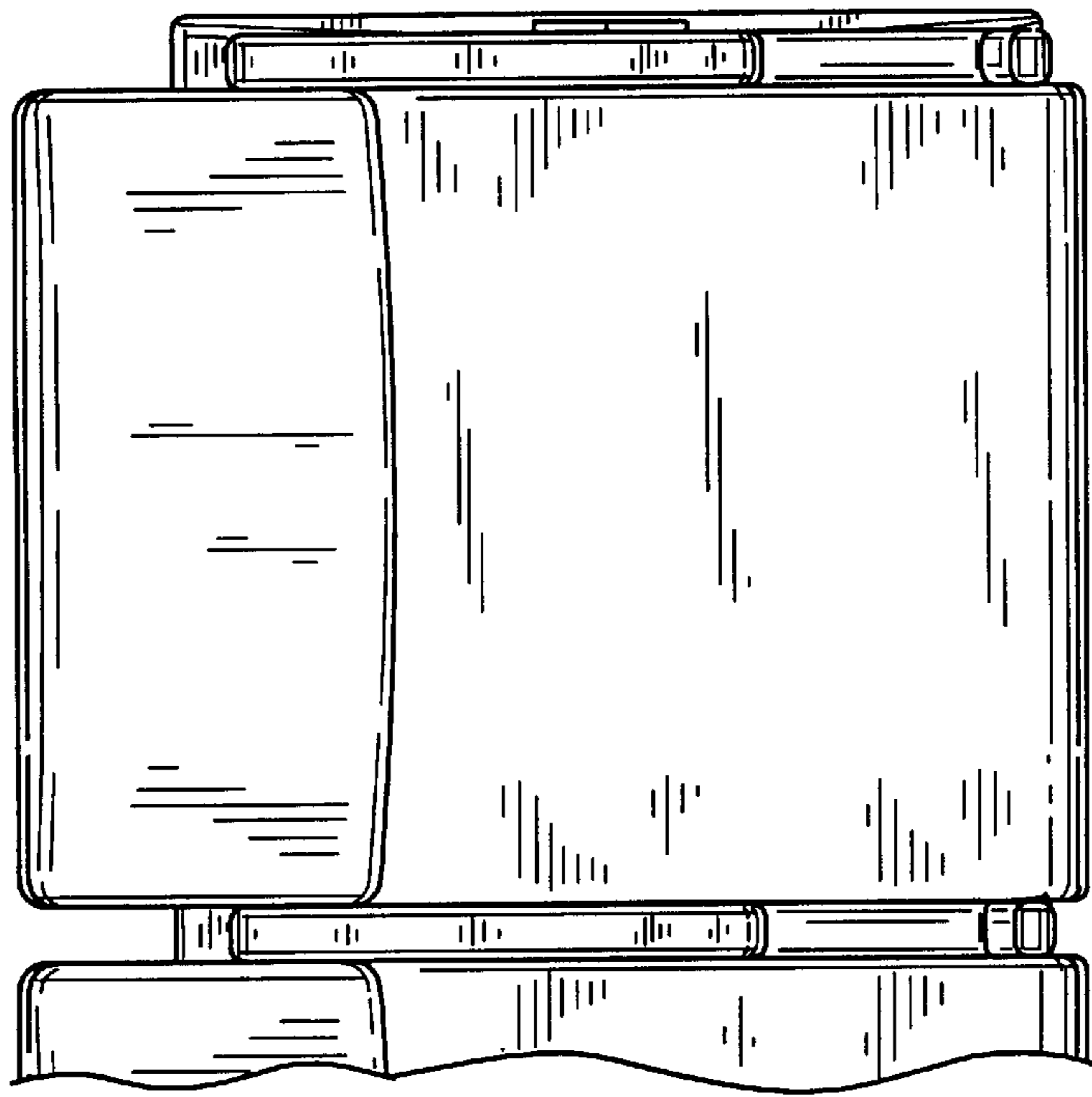

FIG. 9

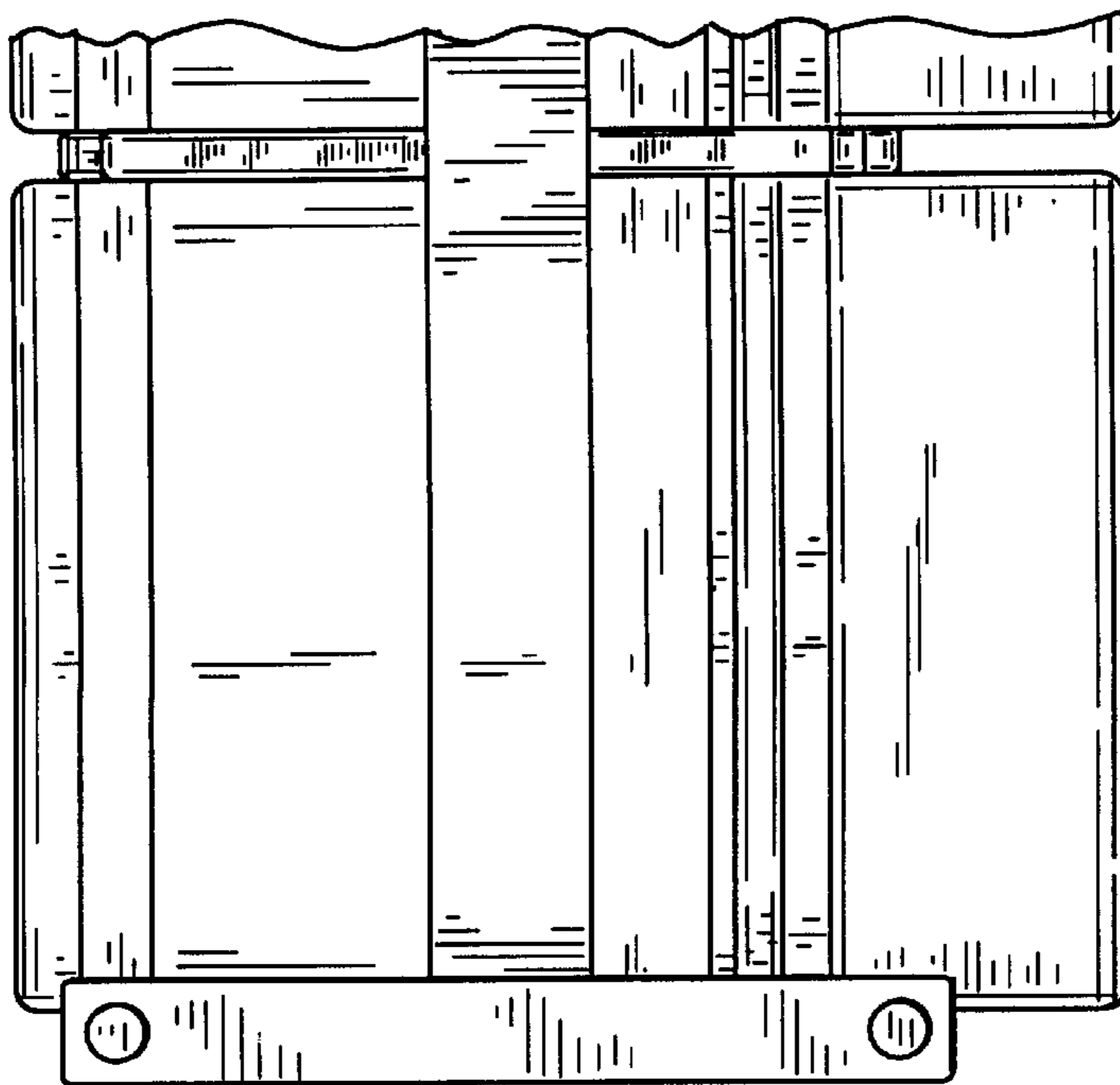
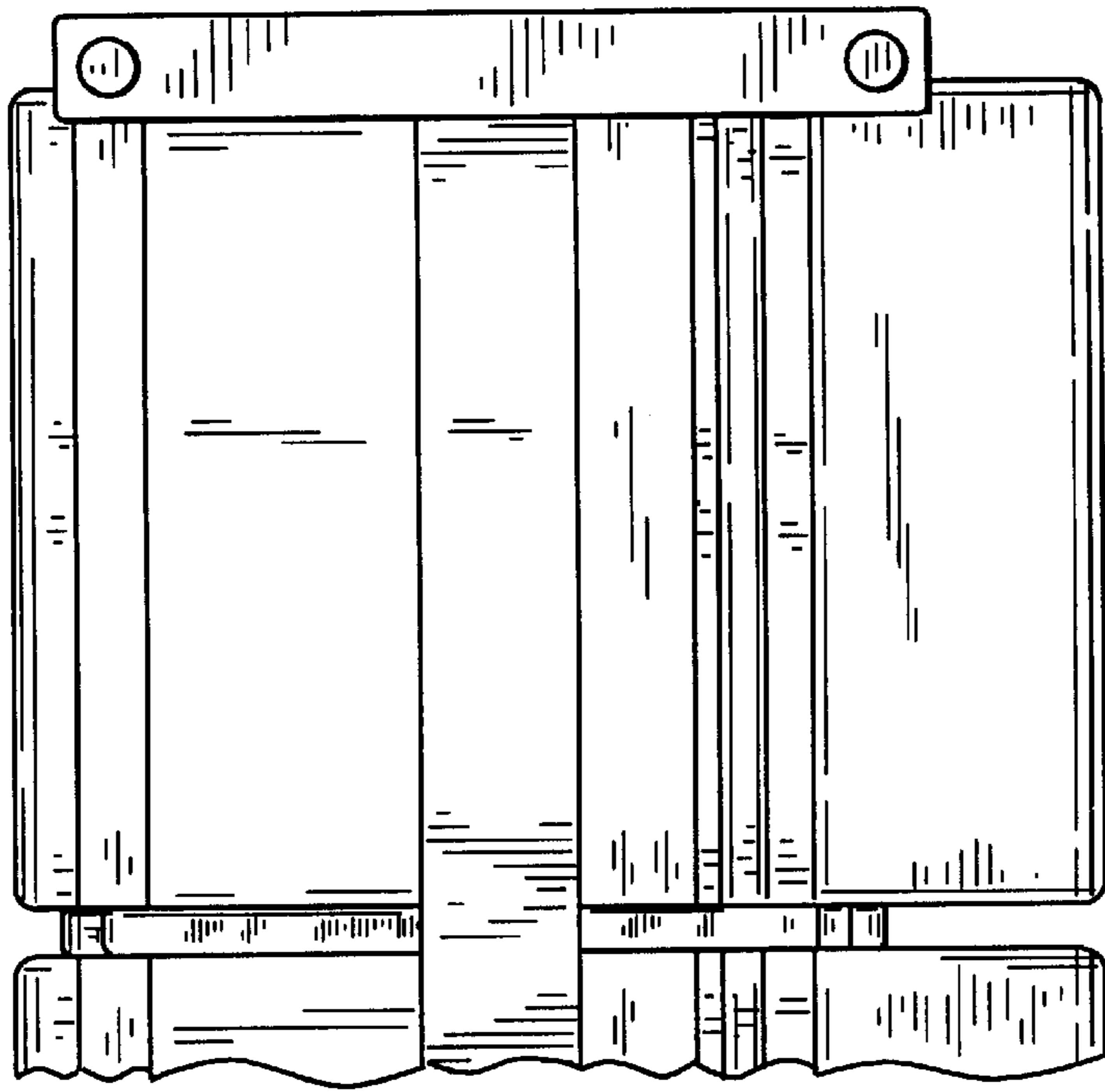

FIG. 10

UNITED STATES PATENT AND TRADEMARK OFFICE
CERTIFICATE OF CORRECTION

PATENT NO. : Des 440,422 S
DATED : April 17, 2001
INVENTOR(S) : Aaron M. DeJule

Page 1 of 1

It is certified that error appears in the above-identified patent and that said Letters Patent is hereby corrected as shown below:

Title page,

Item [75], Inventors: delete "Jr." after "Aaron M. DeJule".

Signed and Sealed this

Twentieth Day of August, 2002

Attest:

A handwritten signature in black ink, appearing to read "James E. Rogan", written over a horizontal line.

Attesting Officer

JAMES E. ROGAN
Director of the United States Patent and Trademark Office