



US00D440334S

(12) **United States Design Patent**
Yuen

(10) **Patent No.:** **US D440,334 S**

(45) **Date of Patent:** **** Apr. 10, 2001**

(54) **LANTERN**

(75) **Inventor:** **Se Kit Yuen, Kwun Tong (HK)**

(73) **Assignee:** **John Manufacturing Limited, Kowloon (HK)**

(**) **Term:** **14 Years**

(21) **Appl. No.:** **29/125,976**

(22) **Filed:** **Jul. 5, 2000**

(30) **Foreign Application Priority Data**

Jan. 6, 2000 (GB) 2089258

(51) **LOC (7) Cl.** **26-02**

(52) **U.S. Cl.** **D26/42**

(58) **Field of Search** D26/37-50; 362/157,
362/158, 183-208

(56) **References Cited**

U.S. PATENT DOCUMENTS

- D. 293,481 * 12/1987 Ohashi D26/42
- D. 356,649 3/1995 Yuen .
- D. 363,563 * 10/1995 Yuen D26/42
- D. 375,374 * 11/1996 Yuen D26/42
- D. 376,864 12/1996 Yuen .
- D. 418,237 * 12/1999 Yuen D26/42
- D. 423,127 * 4/2000 Yuen D26/42

D. 427,698 7/2000 Yuen .

* cited by examiner

Primary Examiner—Marcus A. Jackson

(74) *Attorney, Agent, or Firm*—Merchant & Gould P.C.

(57) **CLAIM**

The ornamental design for a lantern, as shown and described.

DESCRIPTION

FIG. 1 is a front plan view of an embodiment of a lantern showing my new design;

FIG. 2 is a rear plan view thereof;

FIG. 3 is a left side plan view thereof;

FIG. 4 is a right side plan view thereof;

FIG. 5 is a top plan view thereof;

FIG. 6 is bottom plan view thereof;

FIG. 7 is a figure similar to that shown in FIG. 2 in an alternative position;

FIG. 8 is a figure similar to that shown in FIG. 3 in an alternative position;

FIG. 9 is a figure similar to that shown in FIG. 1 in an alternative position; and,

FIG. 10 is a figure similar to that shown in FIG. 5 in an alternative position.

1 Claim, 3 Drawing Sheets

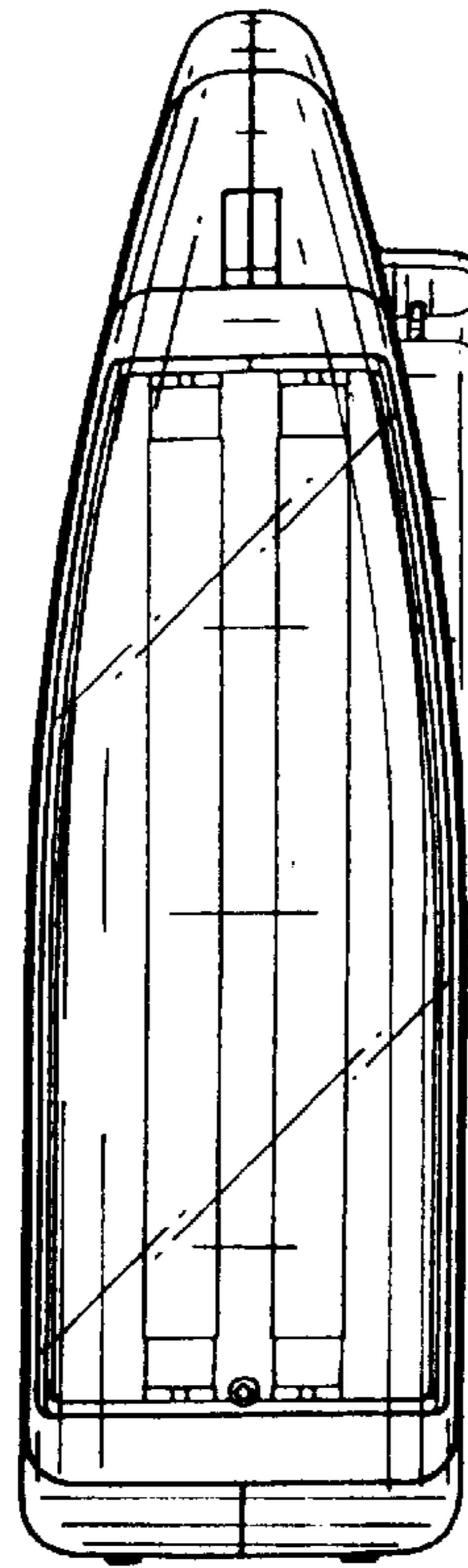
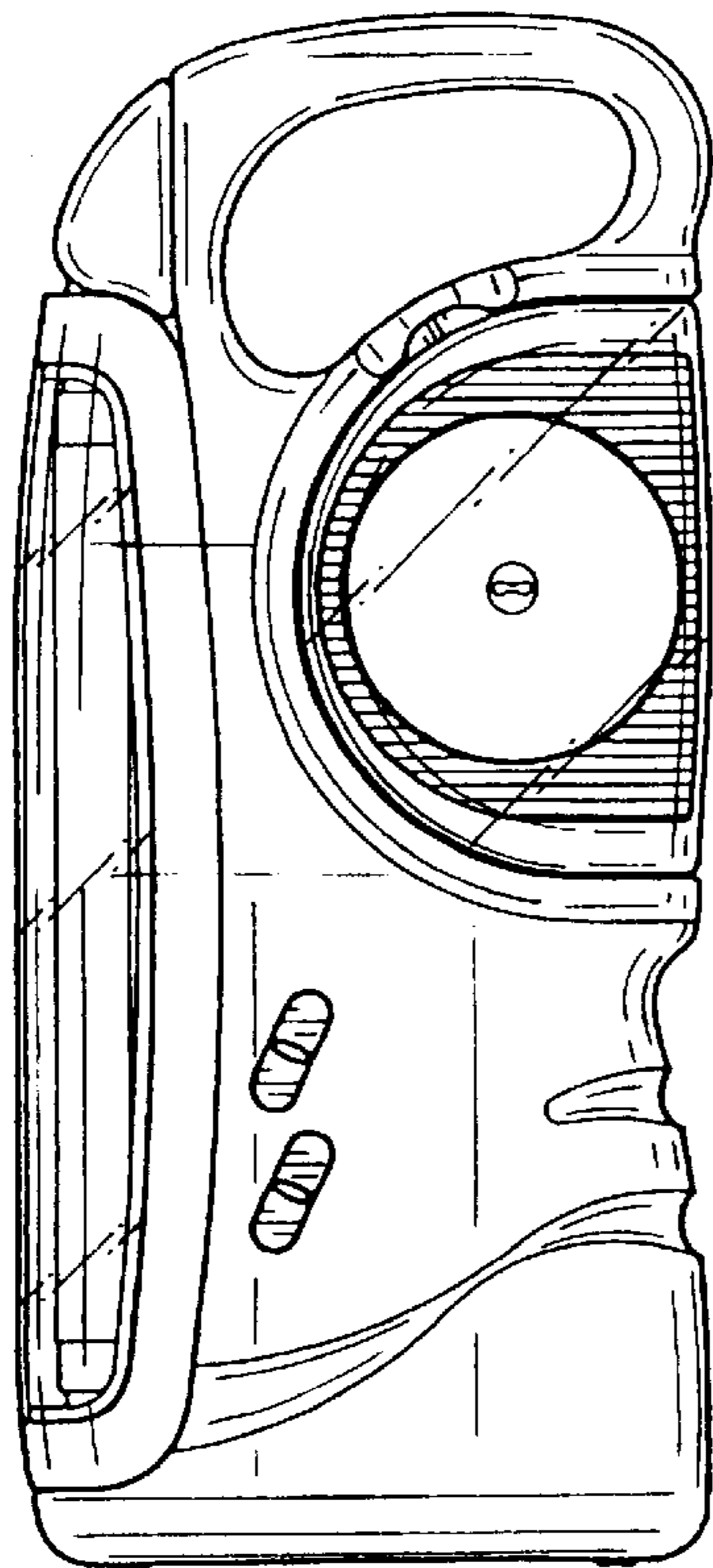

FIG. 1

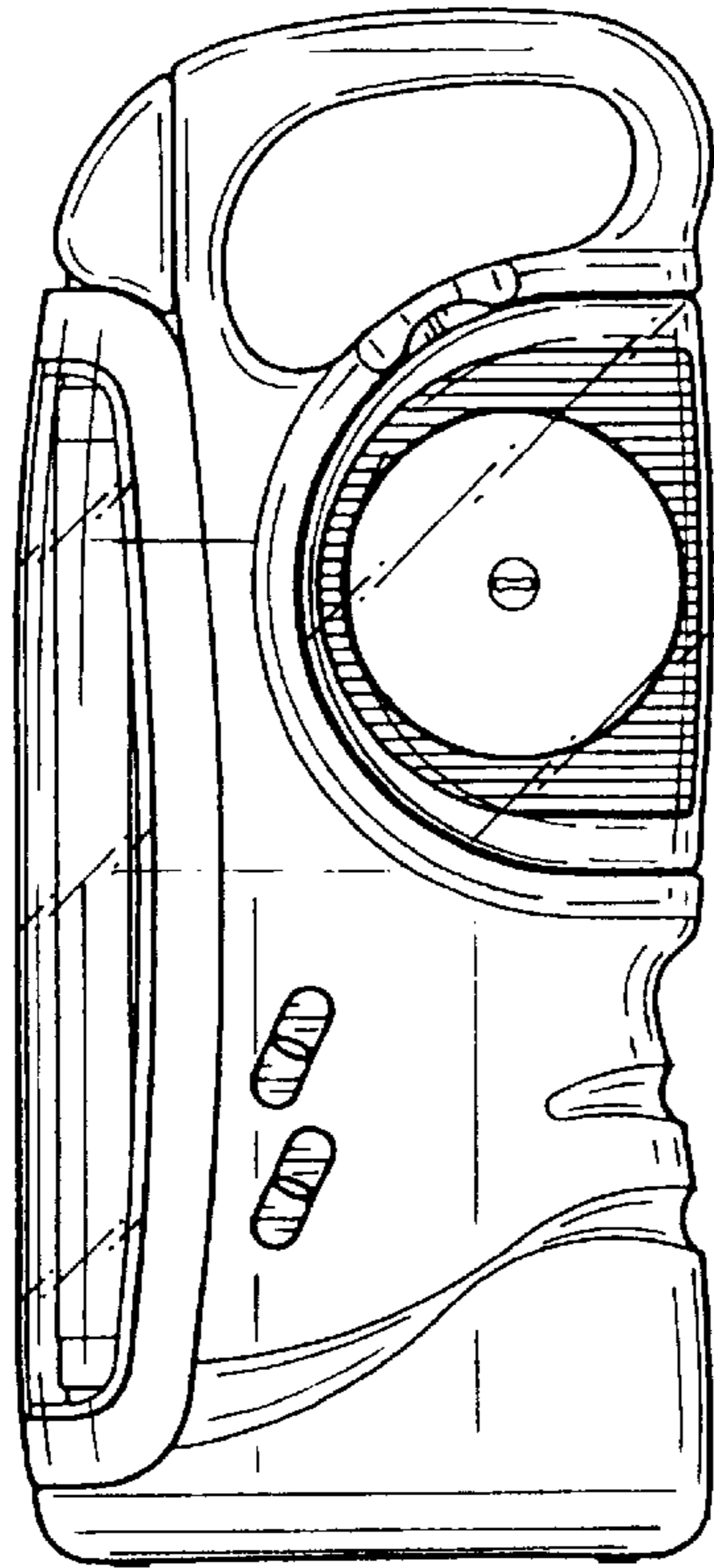

FIG. 2

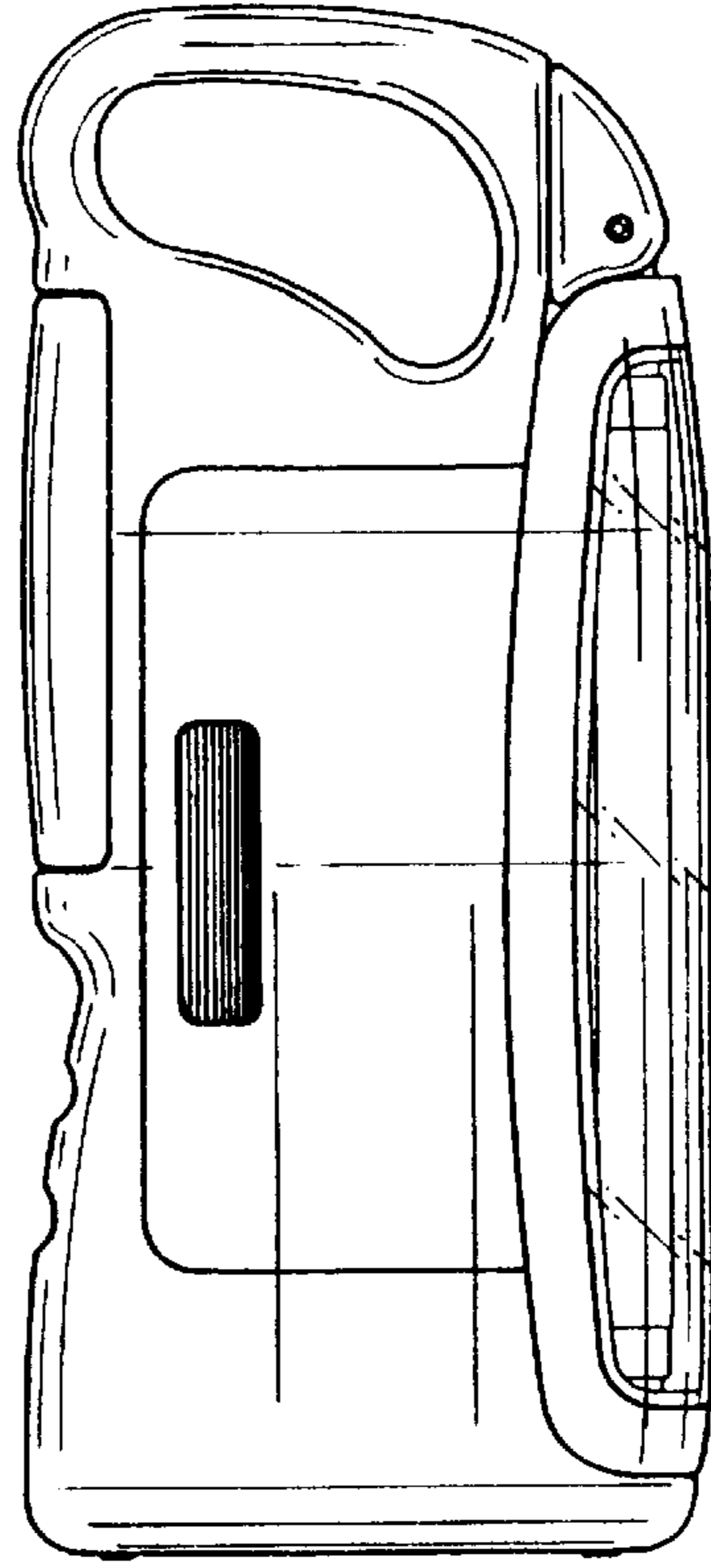

FIG. 3

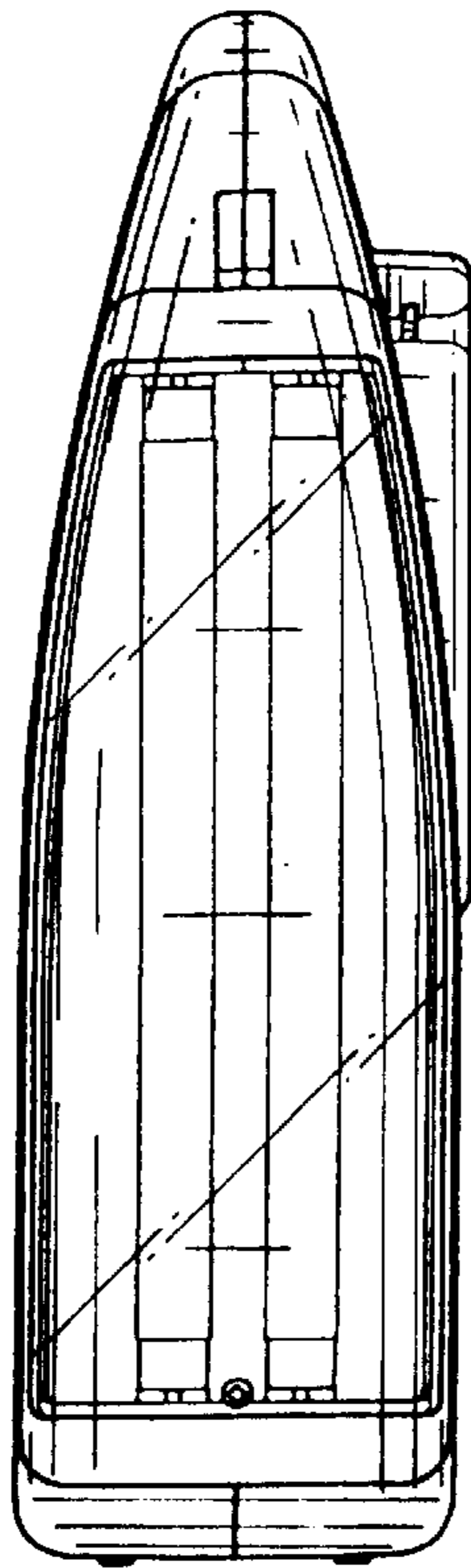

FIG. 4

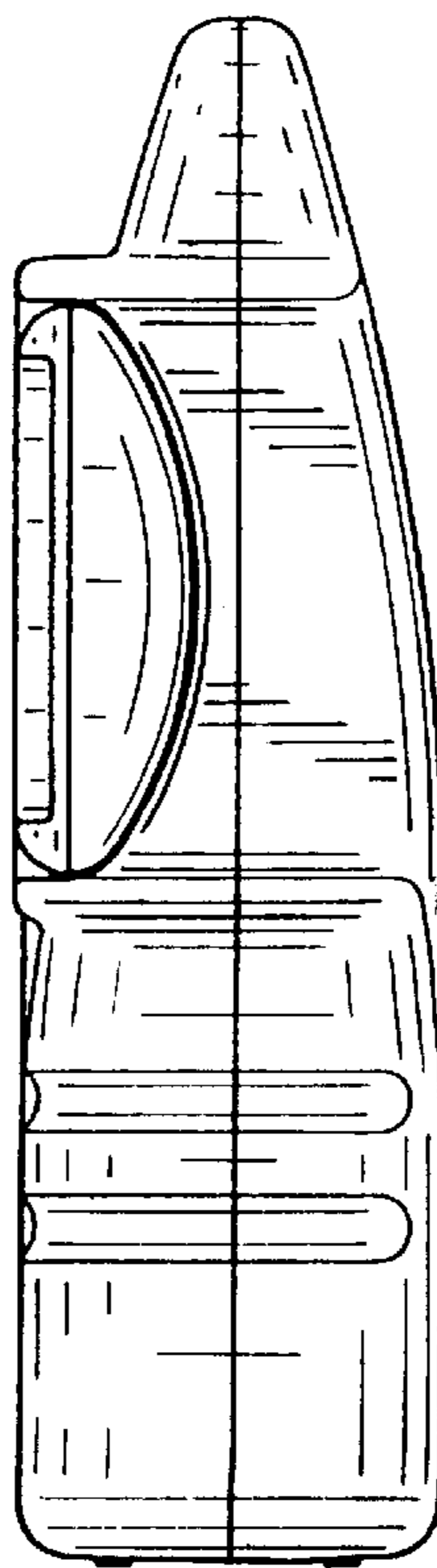

FIG. 5

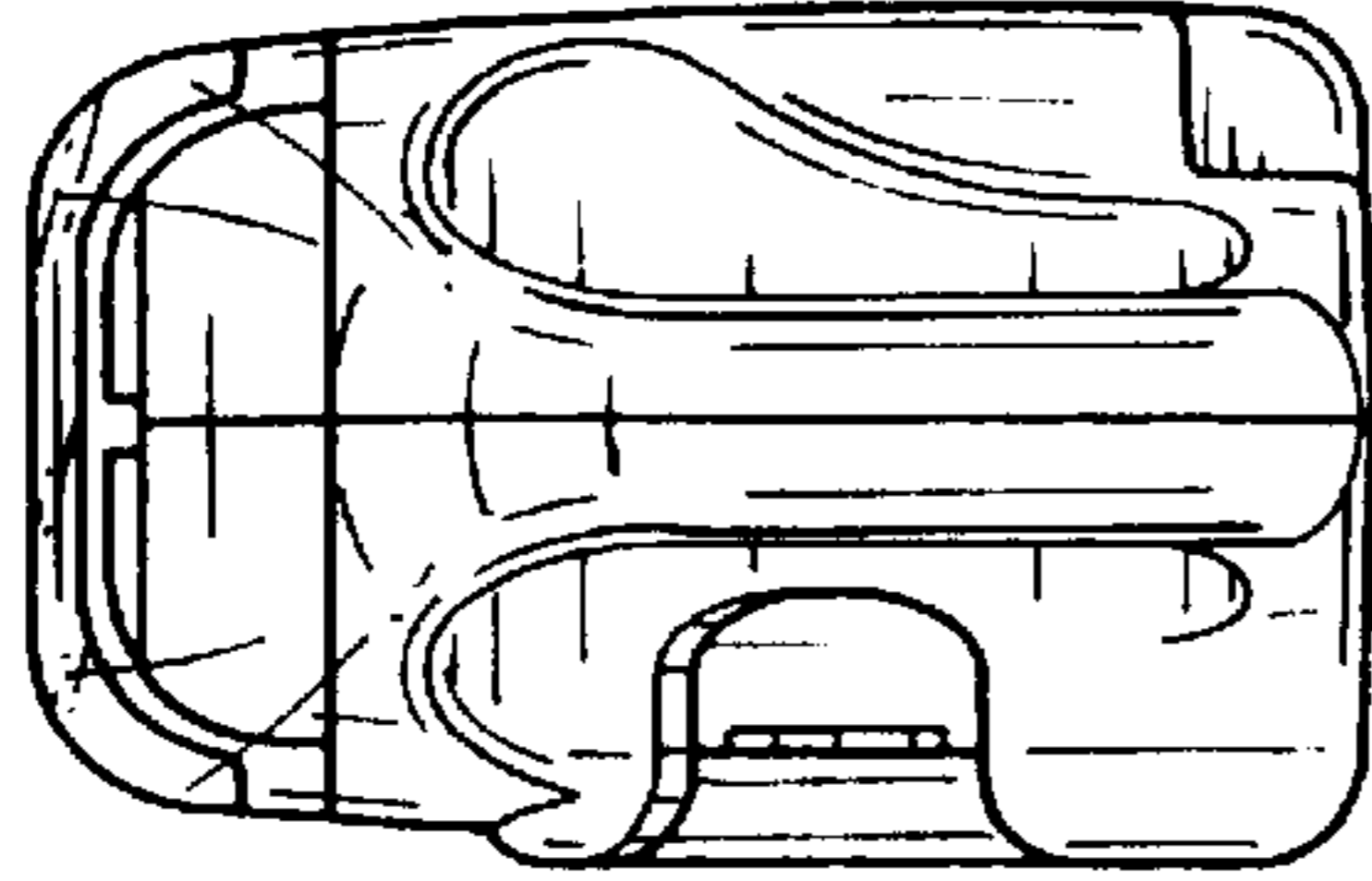

FIG. 6

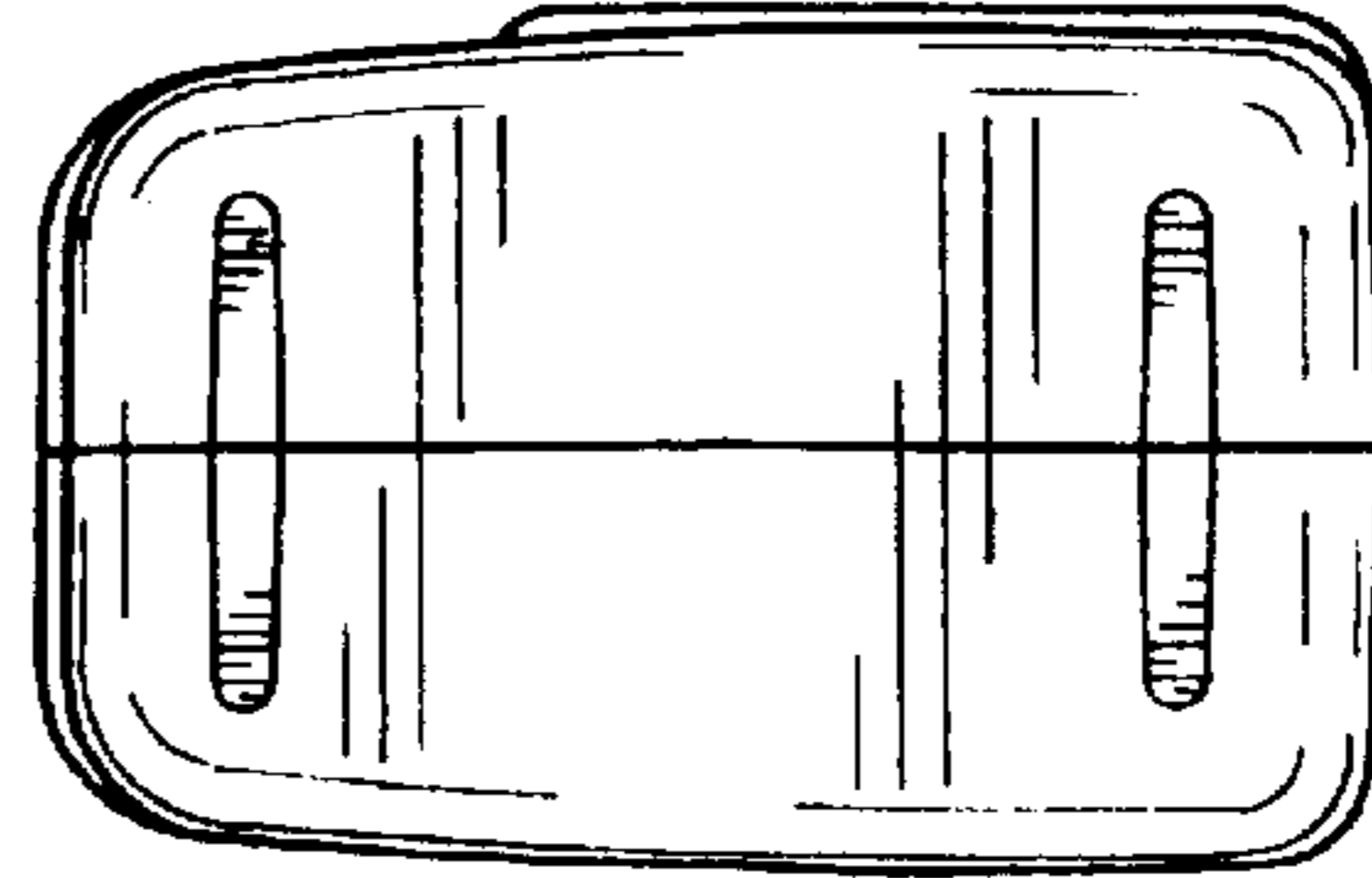

FIG. 7

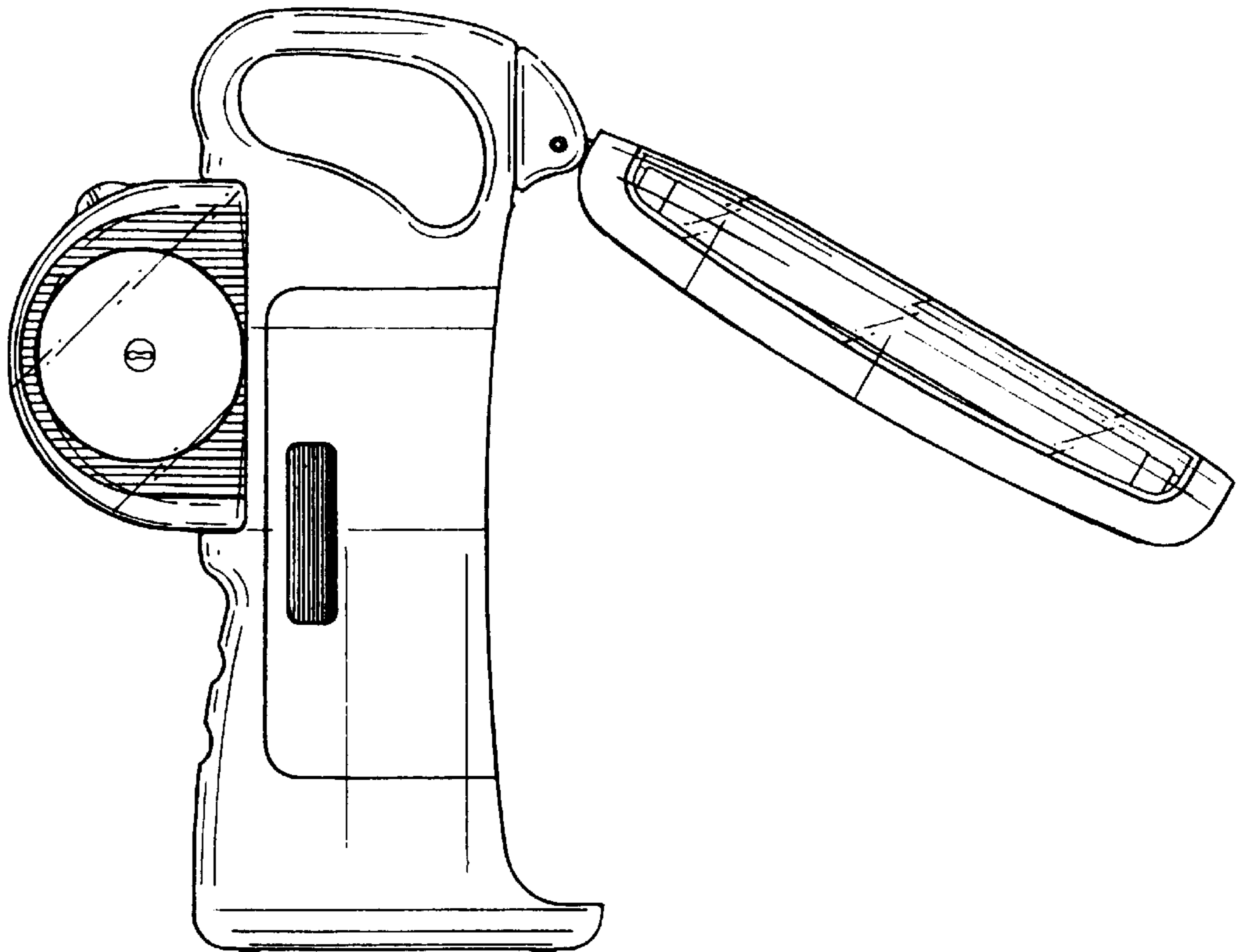

FIG. 8

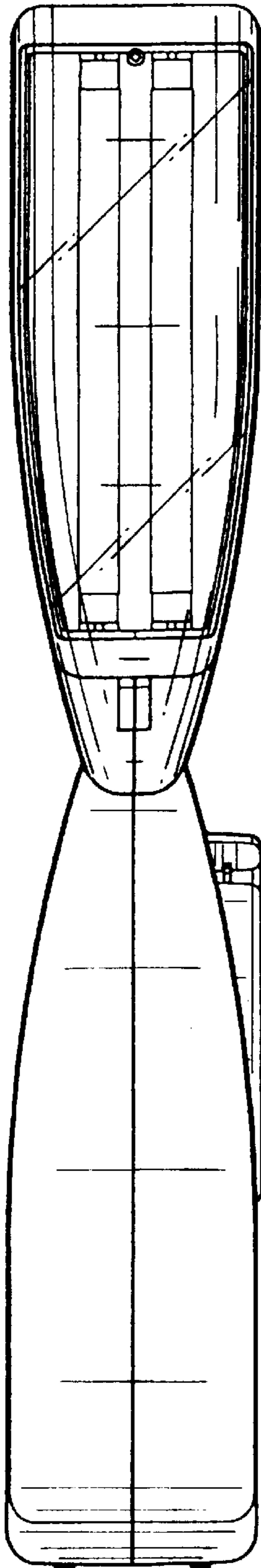

FIG. 9

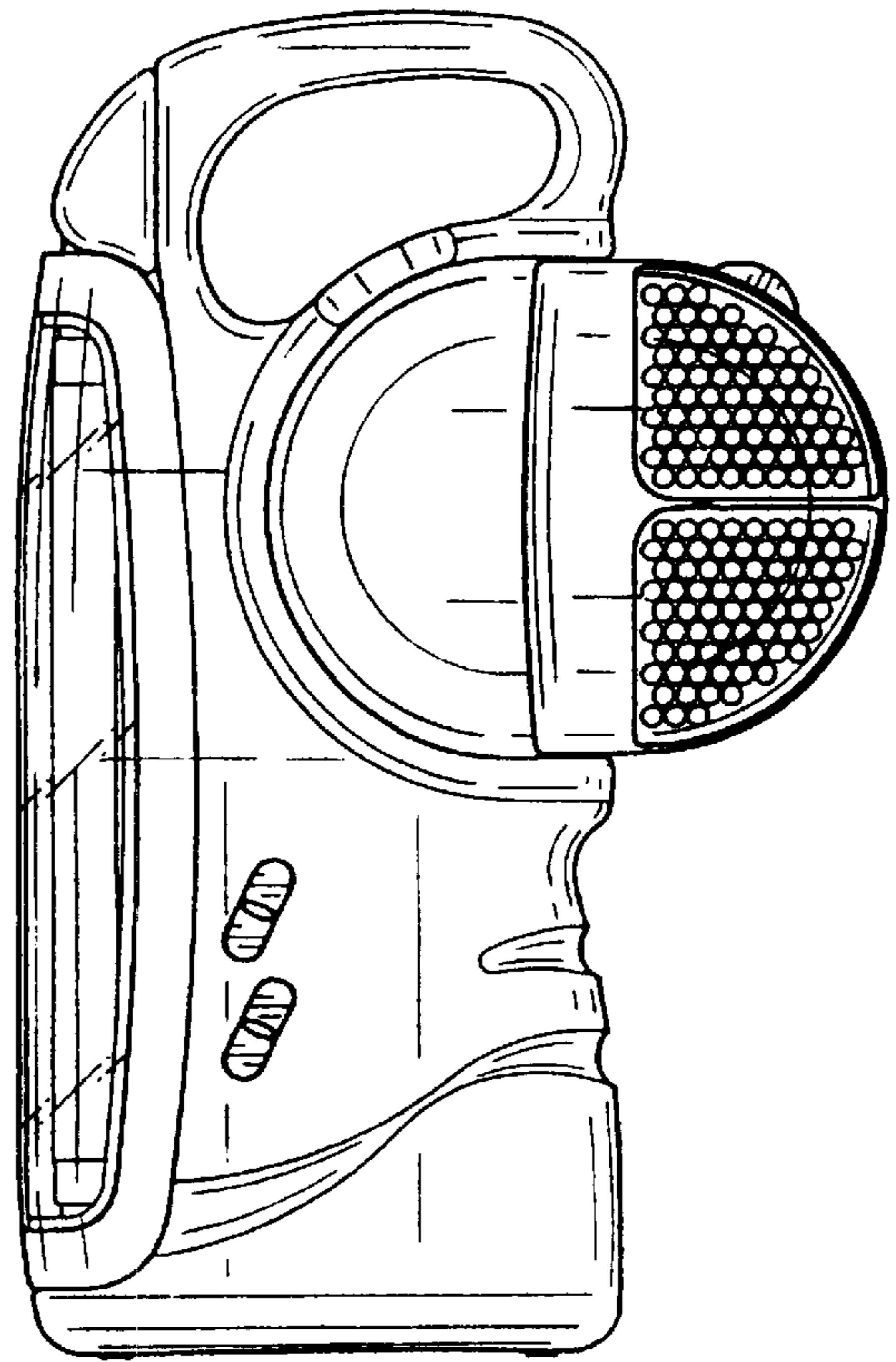

FIG. 10

