



US00D440326S

(12) **United States Design Patent**
Kohlberger et al.

(10) **Patent No.:** **US D440,326 S**

(45) **Date of Patent:** **** Apr. 10, 2001**

(54) **SQUARE COLUMN BASE**

(76) Inventors: **Walter Kohlberger; Ward Kohlberger**, both of 347 Arvin Avenue, Stoney Creek, Ontario (CA), L8E 2M6

(**) Term: **14 Years**

(21) Appl. No.: **29/128,982**

(22) Filed: **Sep. 7, 2000**

(51) **LOC (7) Cl.** **25-01**

(52) **U.S. Cl.** **D25/133**

(58) **Field of Search** 52/297, 292, 301, 52/298; D25/133, 134; 248/188.1, 346, 188.8

(56) **References Cited**

U.S. PATENT DOCUMENTS

D. 392,753	*	3/1998	Kohlberger et al.	D25/133
4,048,776	*	9/1977	Sato	52/297
4,641,467	*	2/1987	Dupuis, Jr.	52/297
4,648,220	*	3/1987	Gebelius	52/292

* cited by examiner

Primary Examiner—Doris Clark

(74) *Attorney, Agent, or Firm*—Mark A. Koch

(57) **CLAIM**

The ornamental design for a square column base, as shown and described.

DESCRIPTION

FIG. 1 is a top plan view of the square column base showing our new design.

FIG. 2 is a side elevational view.

FIG. 3 is a bottom plan view thereof.

FIG. 4 is a top perspective view of the square column base shown in FIGS. 1 to 3.

FIG. 5 is a cross sectional view taken along line 5—5 shown in FIG. 2.

FIG. 6 is a bottom perspective view of the square column base shown in FIGS. 1 to 3.

FIG. 7 is a top plan view of a second embodiment of the square column base showing our new design.

FIG. 8 is a side elevational view.

FIG. 9 is a bottom plan view thereof.

FIG. 10 is a top perspective view of the square column base shown in FIGS. 7–9.

FIG. 11 is a cross sectional view taken along line 11—11 shown in FIG. 8; and,

FIG. 12 is a bottom perspective view of the square column base shown in FIGS. 7 to 9.

1 Claim, 8 Drawing Sheets

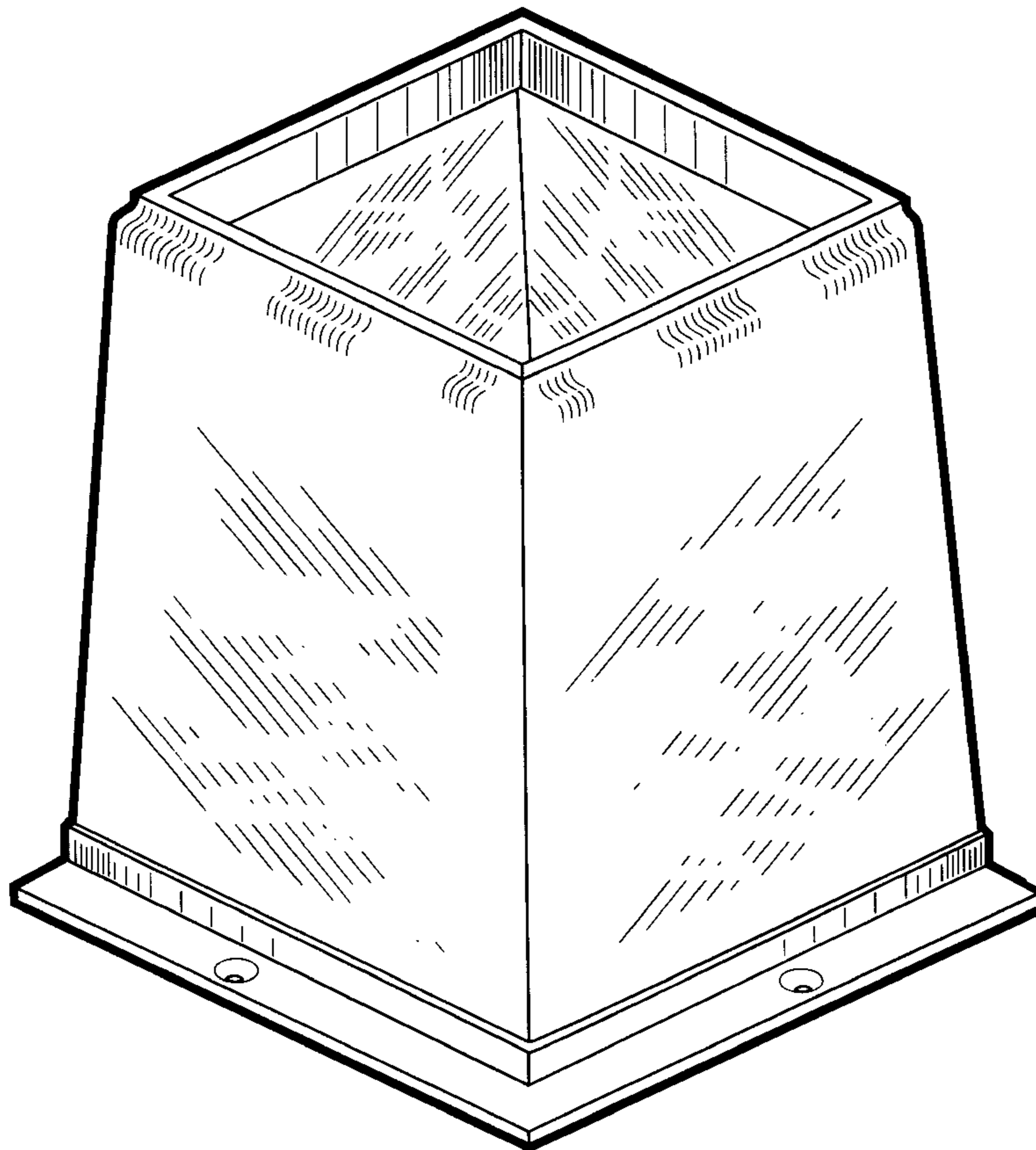

FIGURE - 1

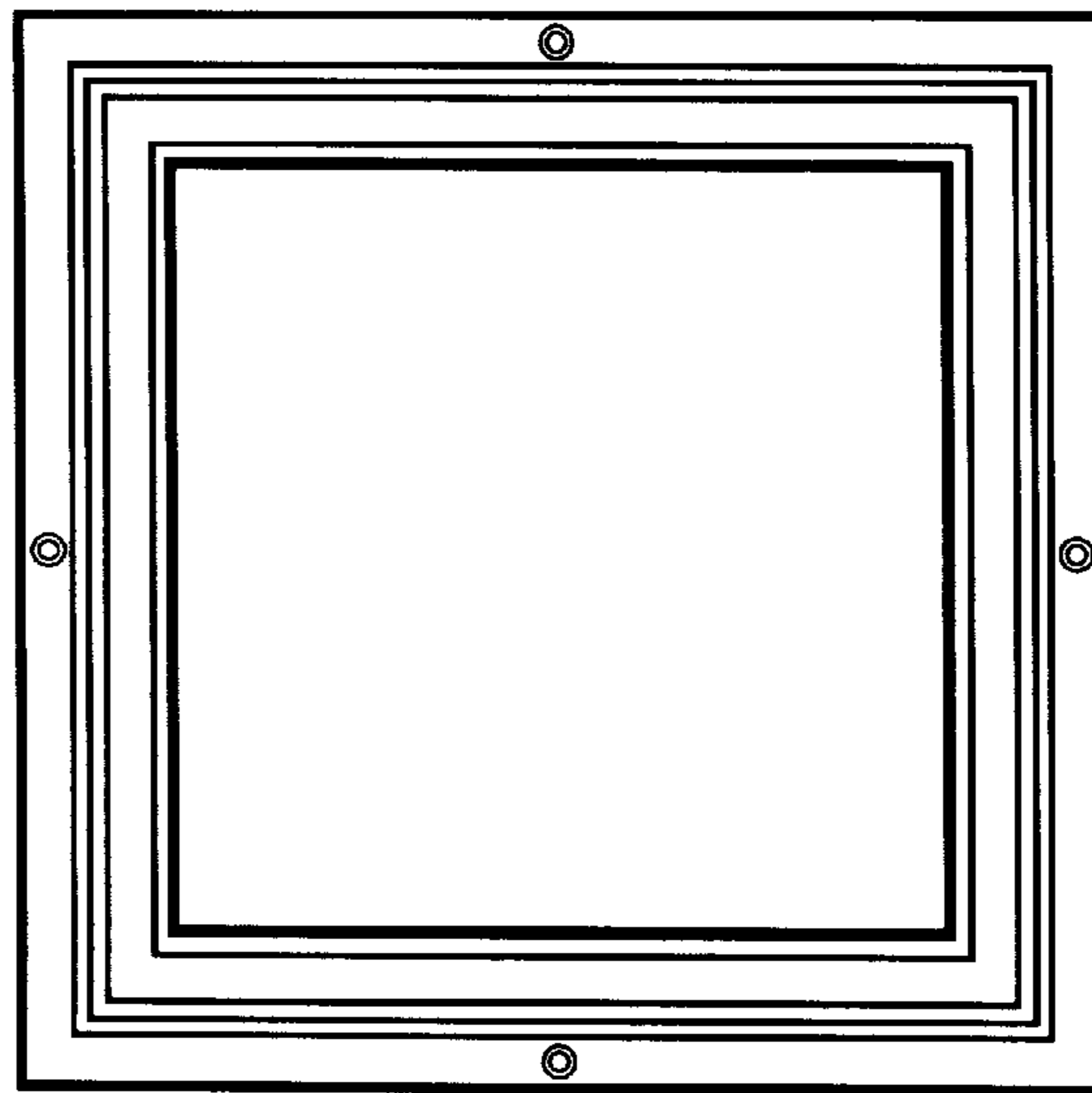

FIGURE - 2

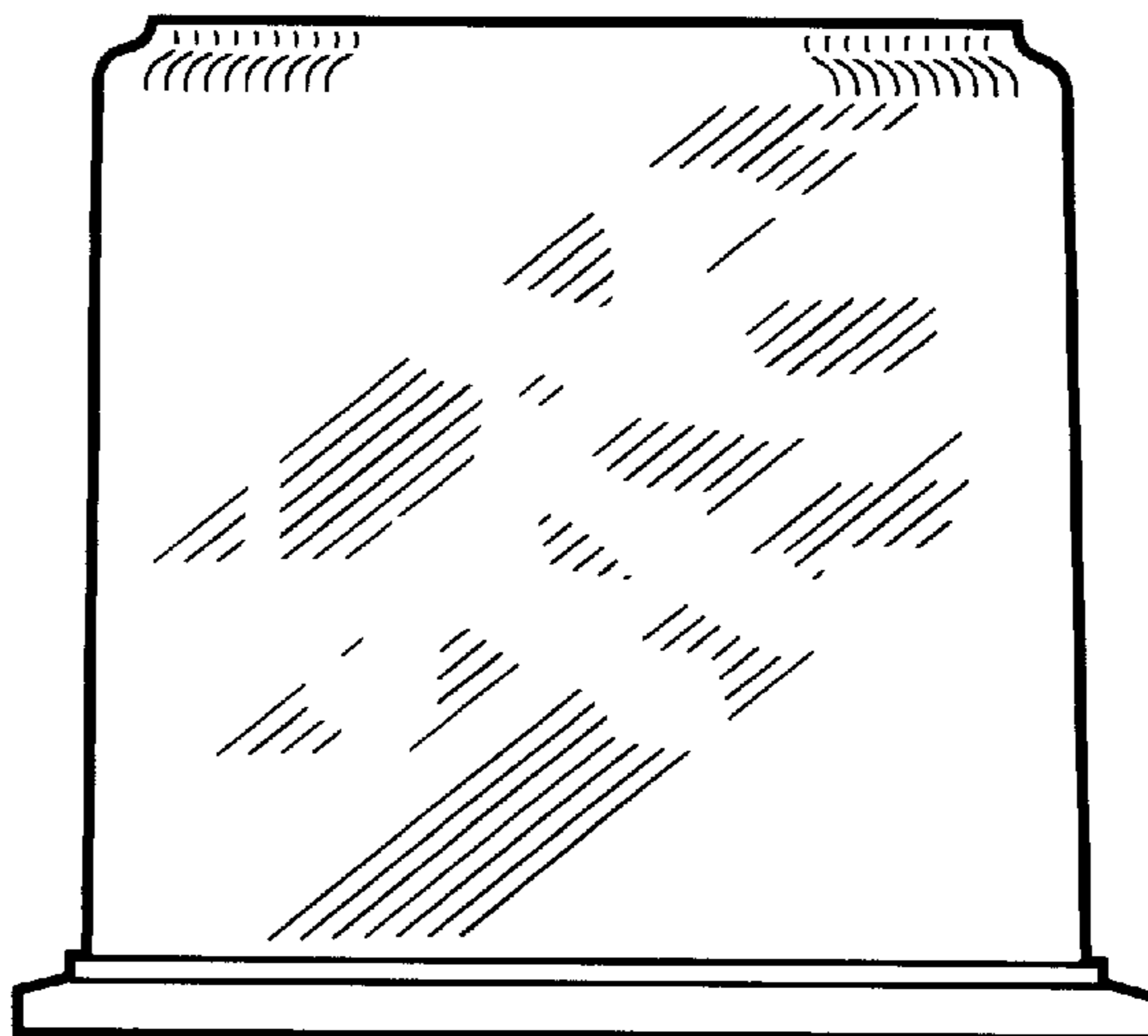

FIGURE - 3

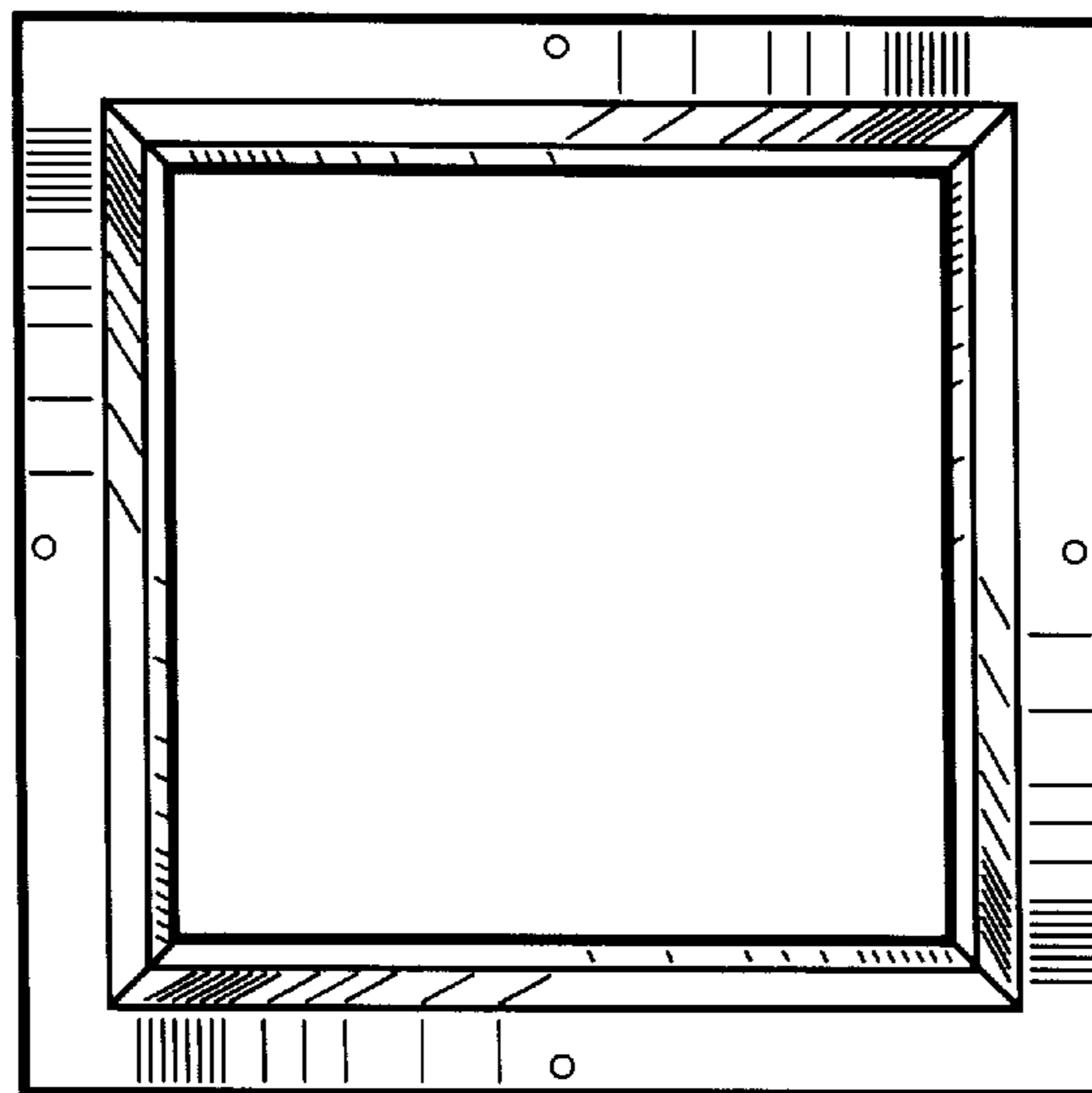

FIGURE - 4

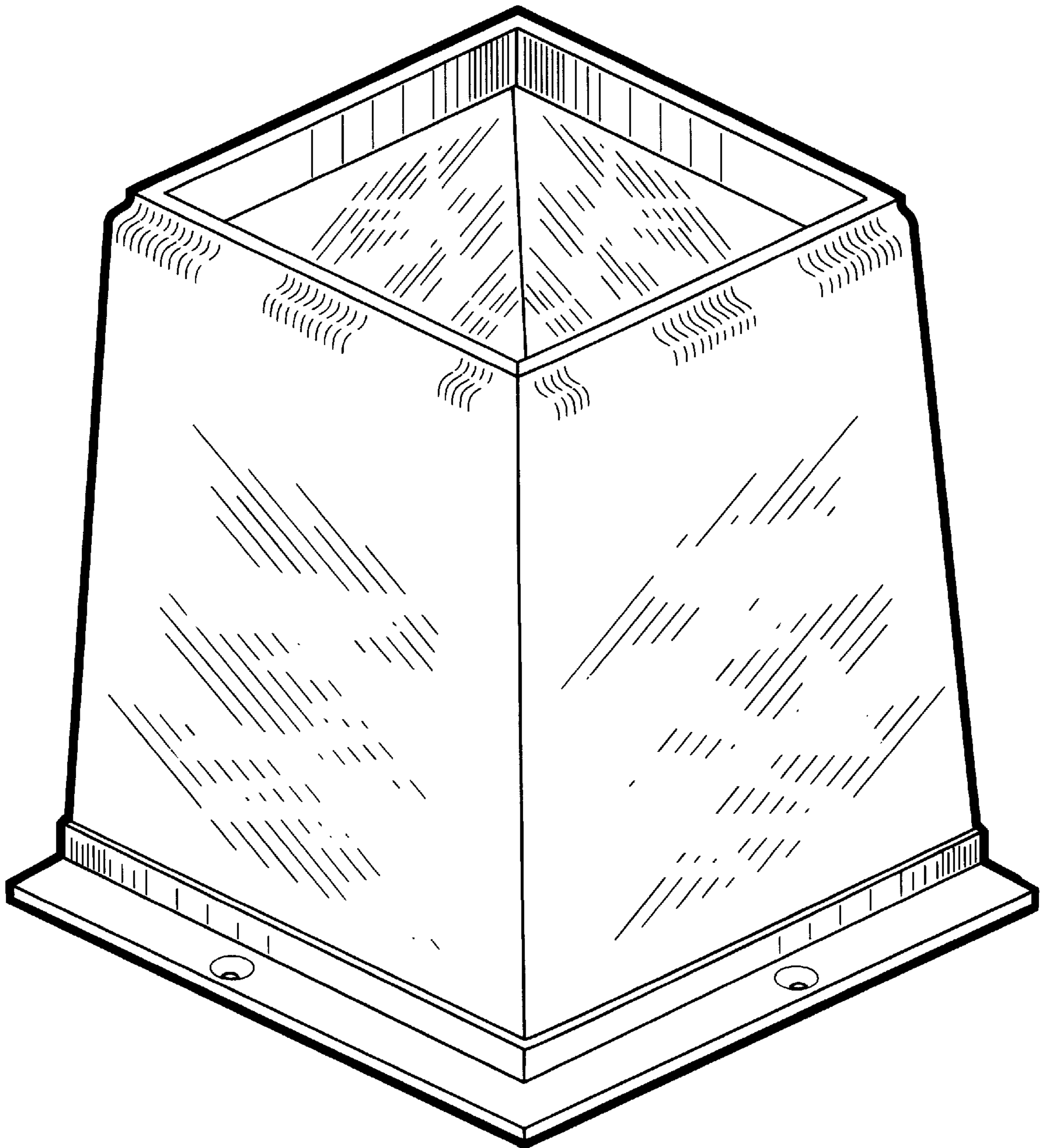

FIGURE - 2

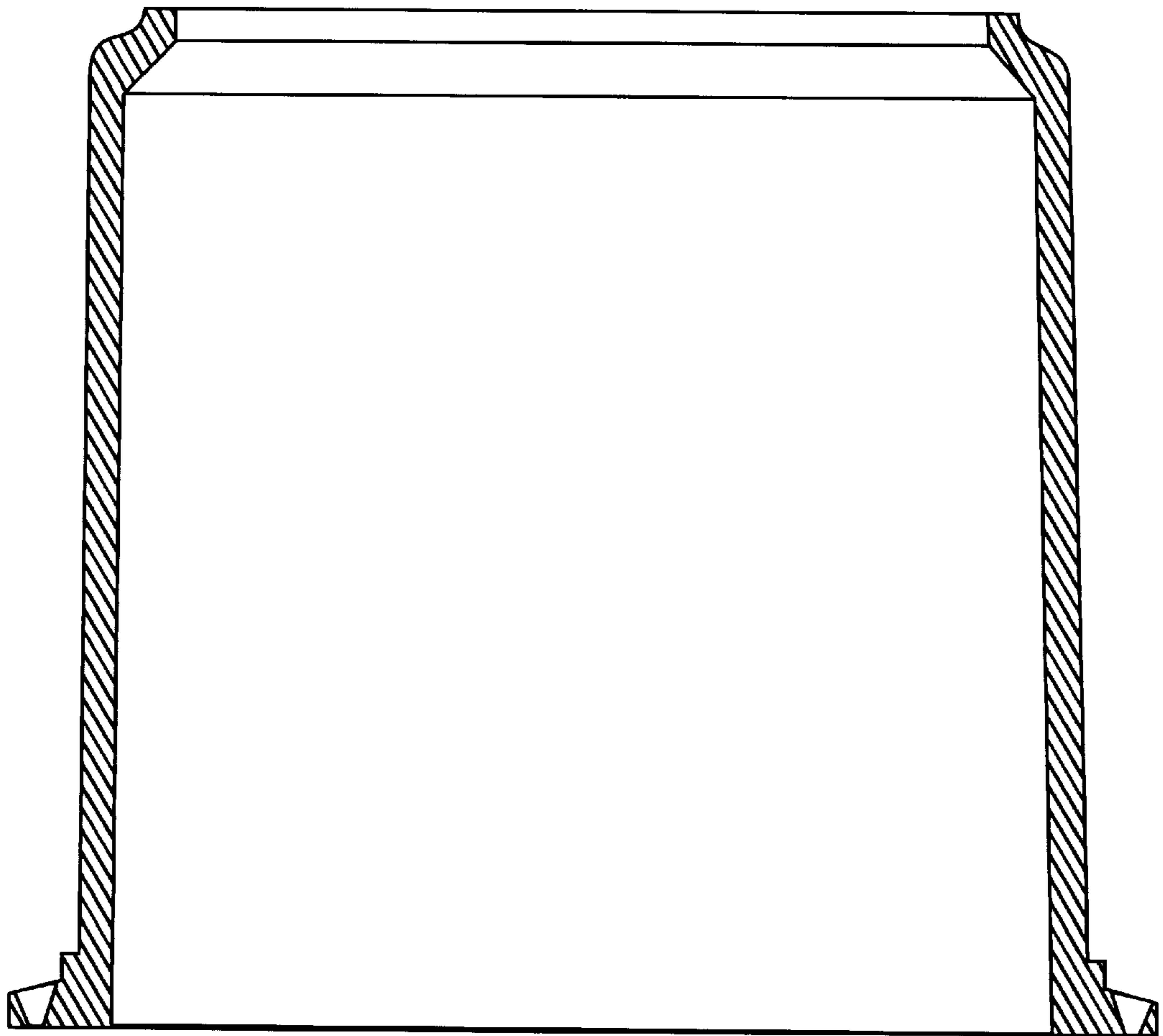
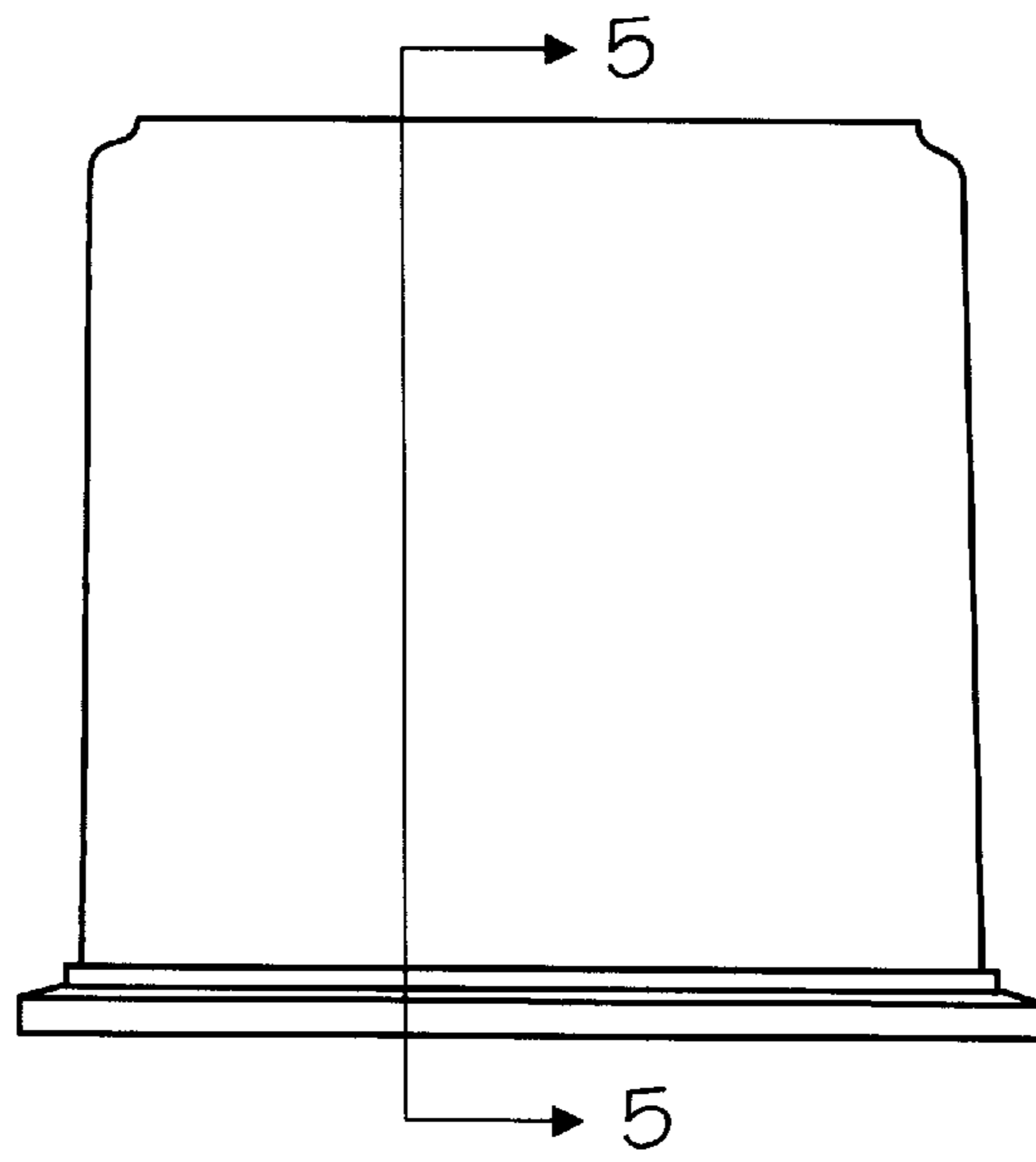

FIGURE - 5

FIGURE - 6

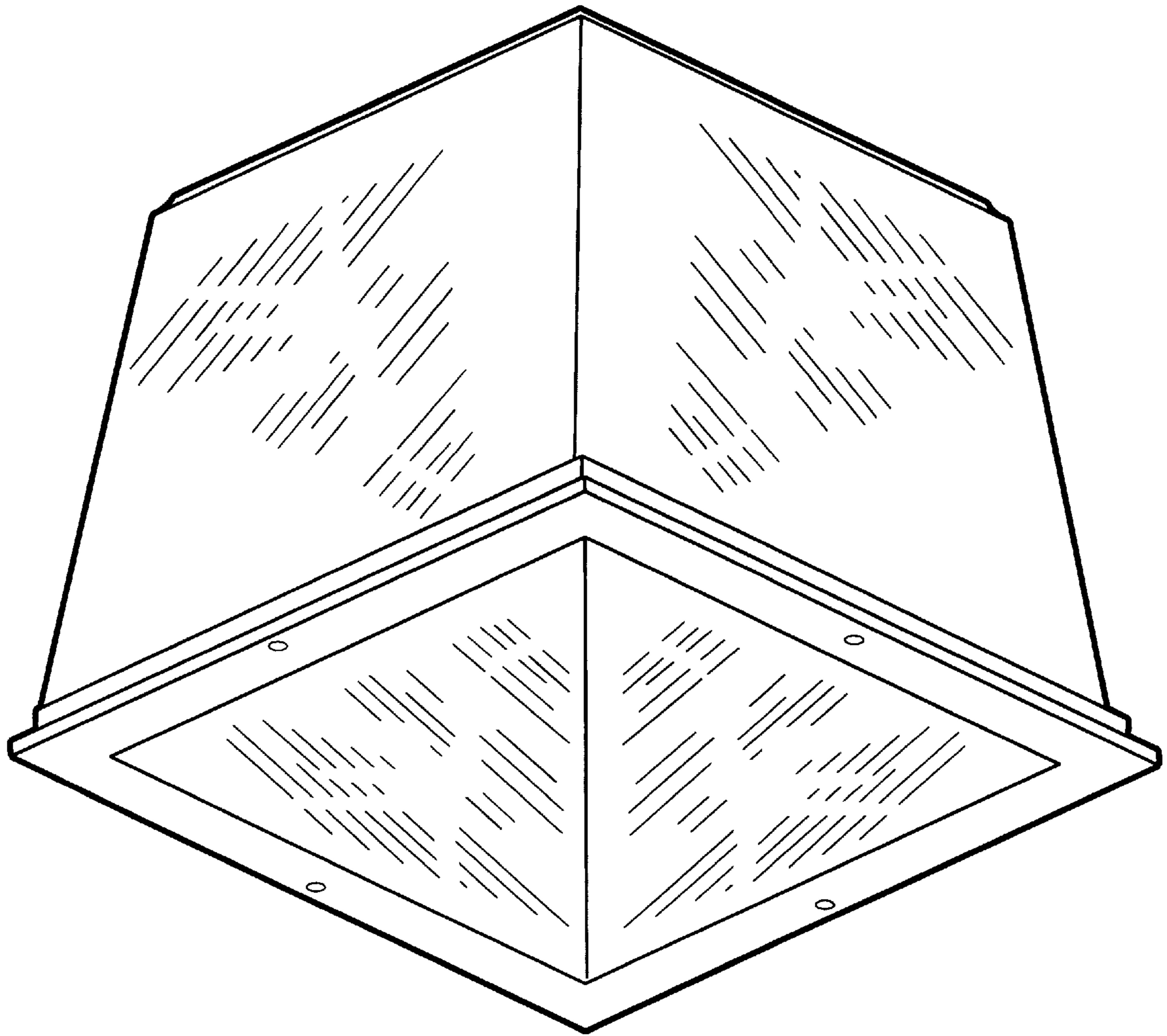

FIGURE - 7

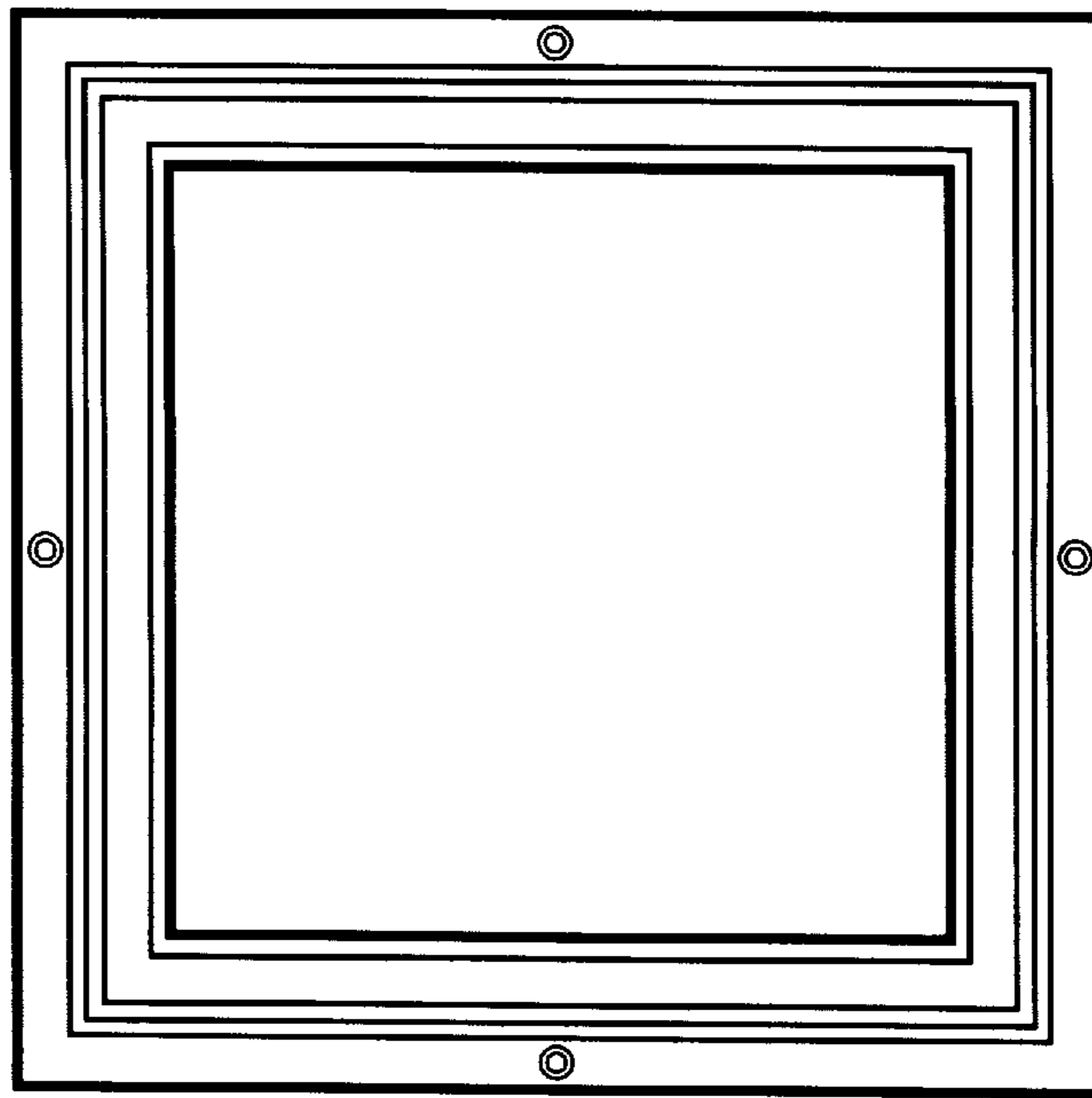

FIGURE - 8

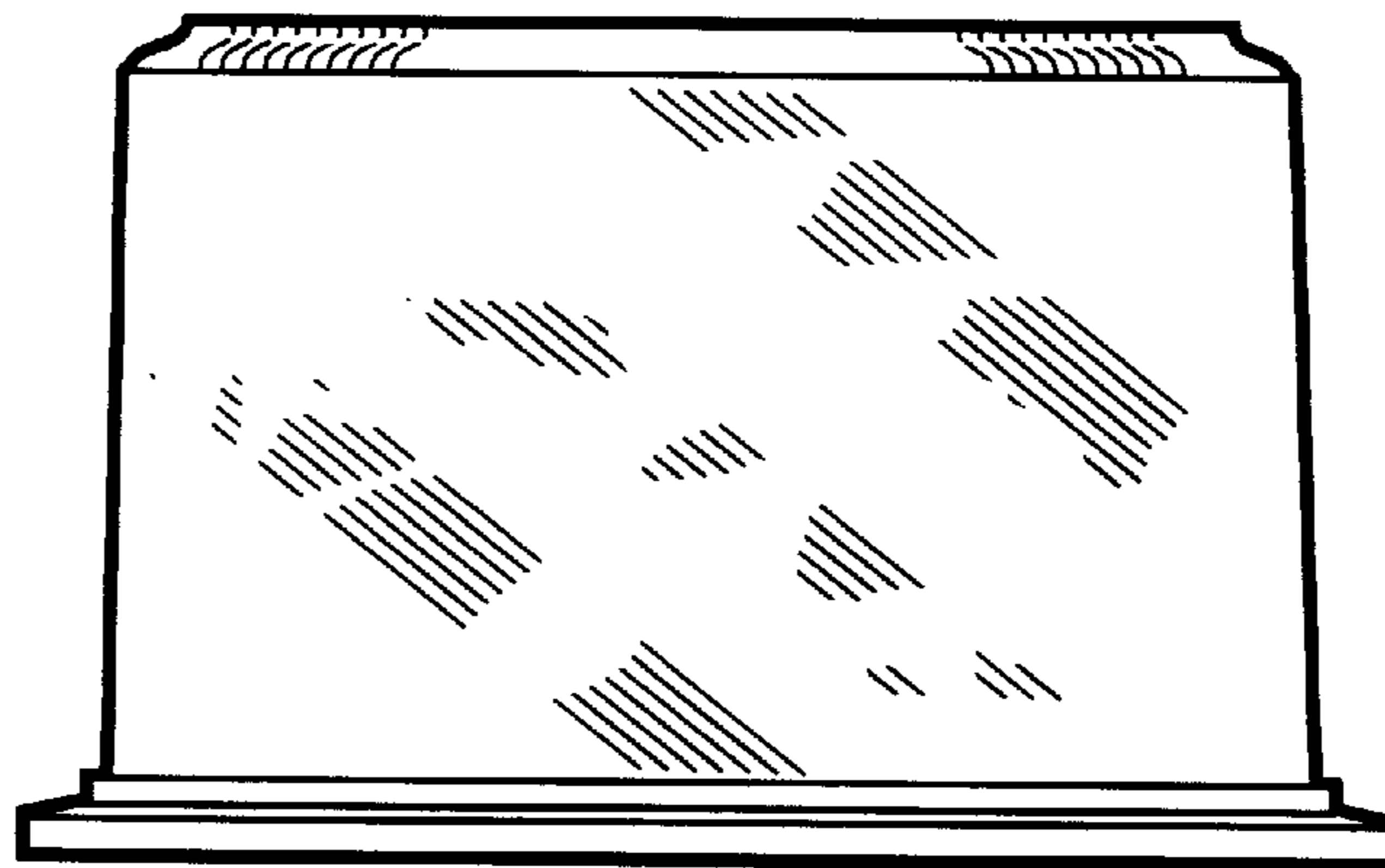

FIGURE - 9

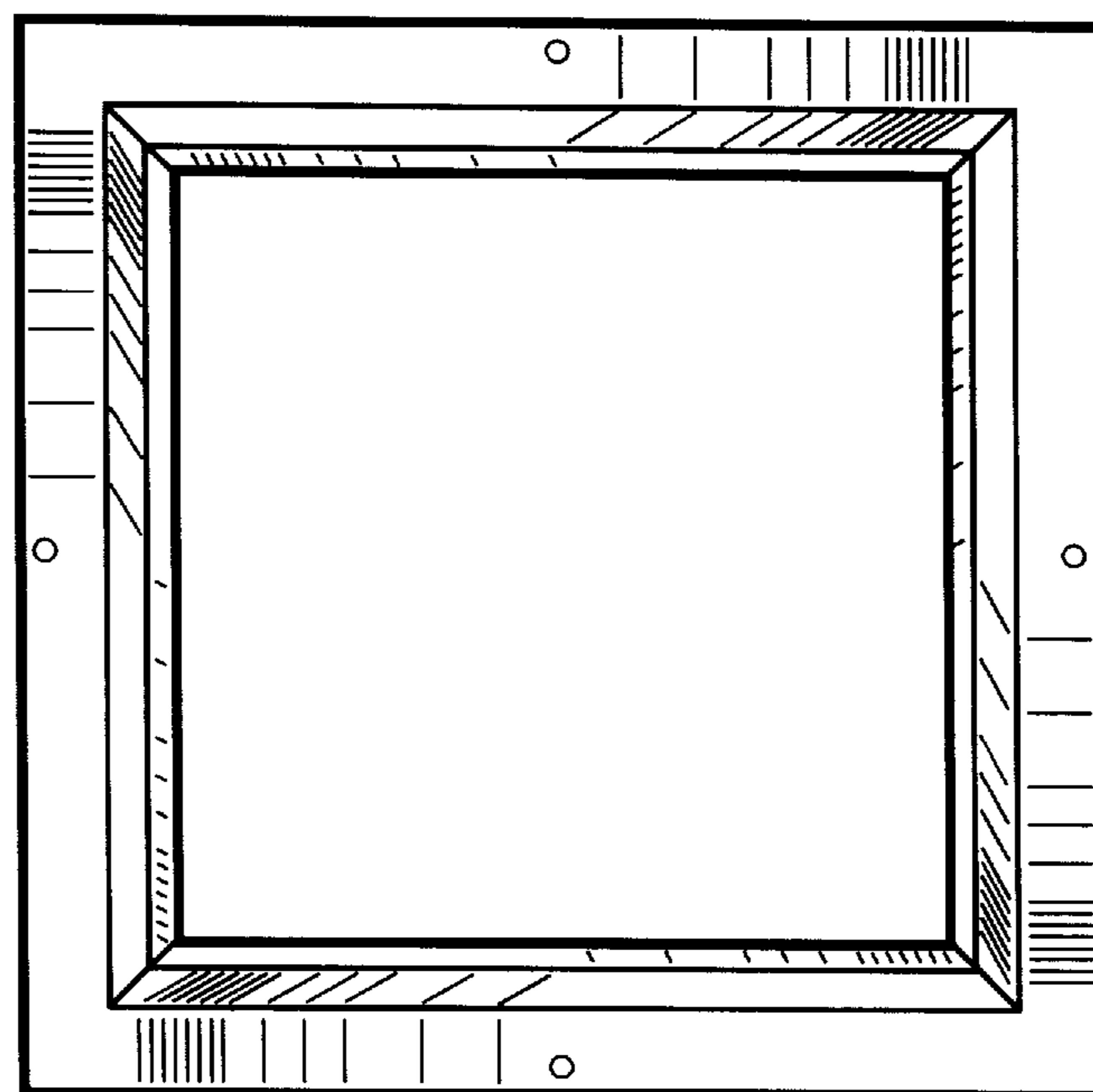

FIGURE - 10

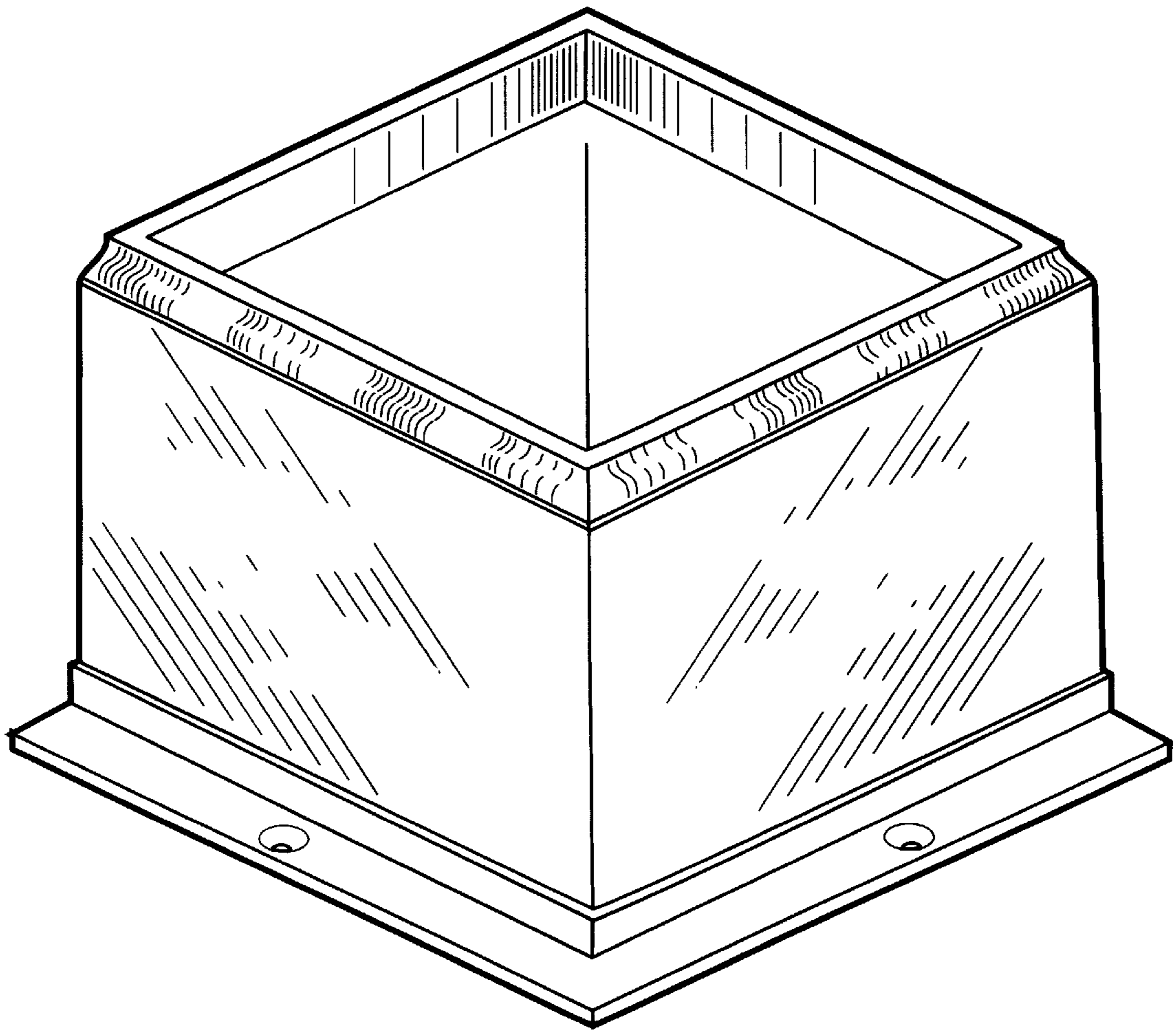

FIGURE - 8

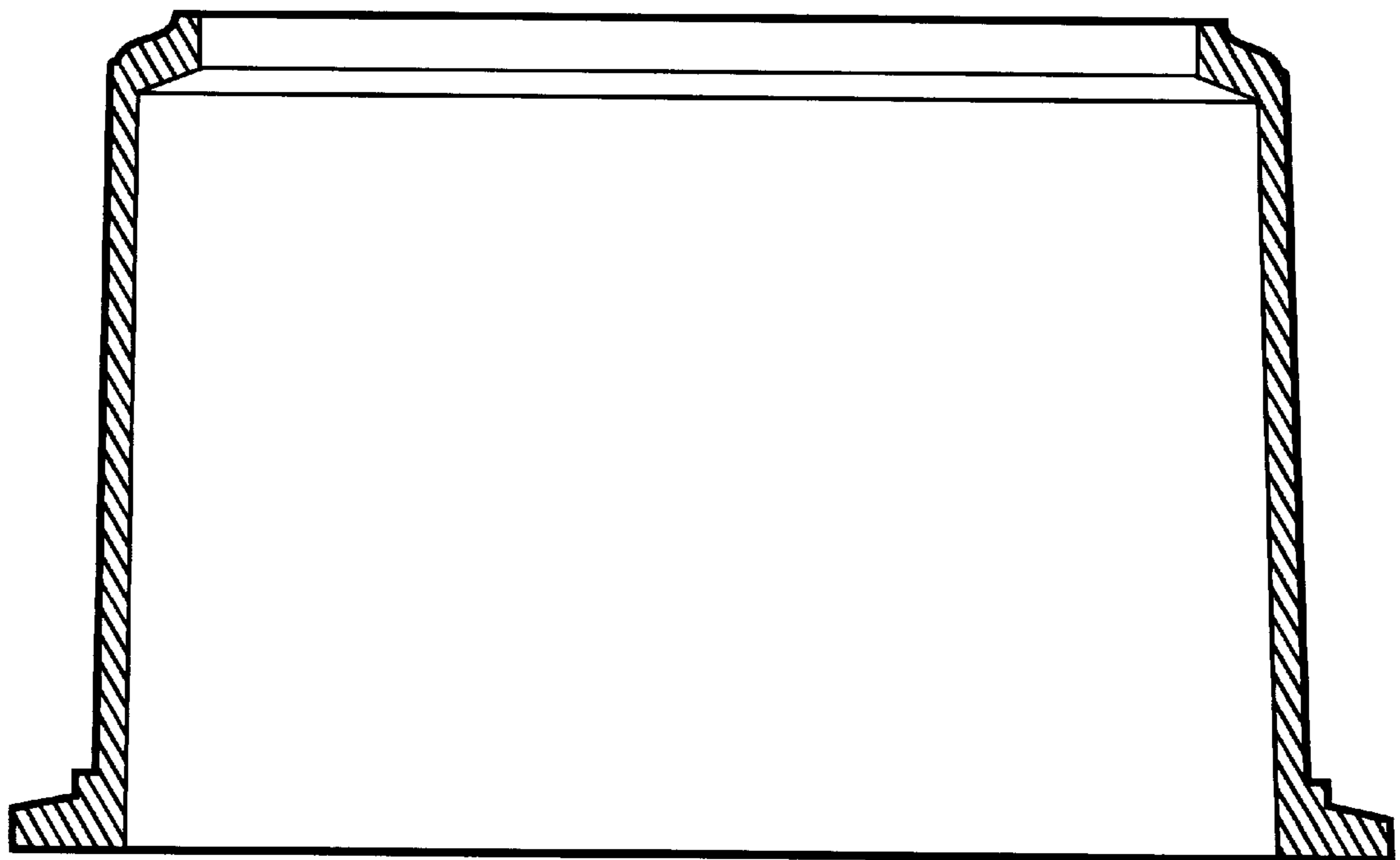
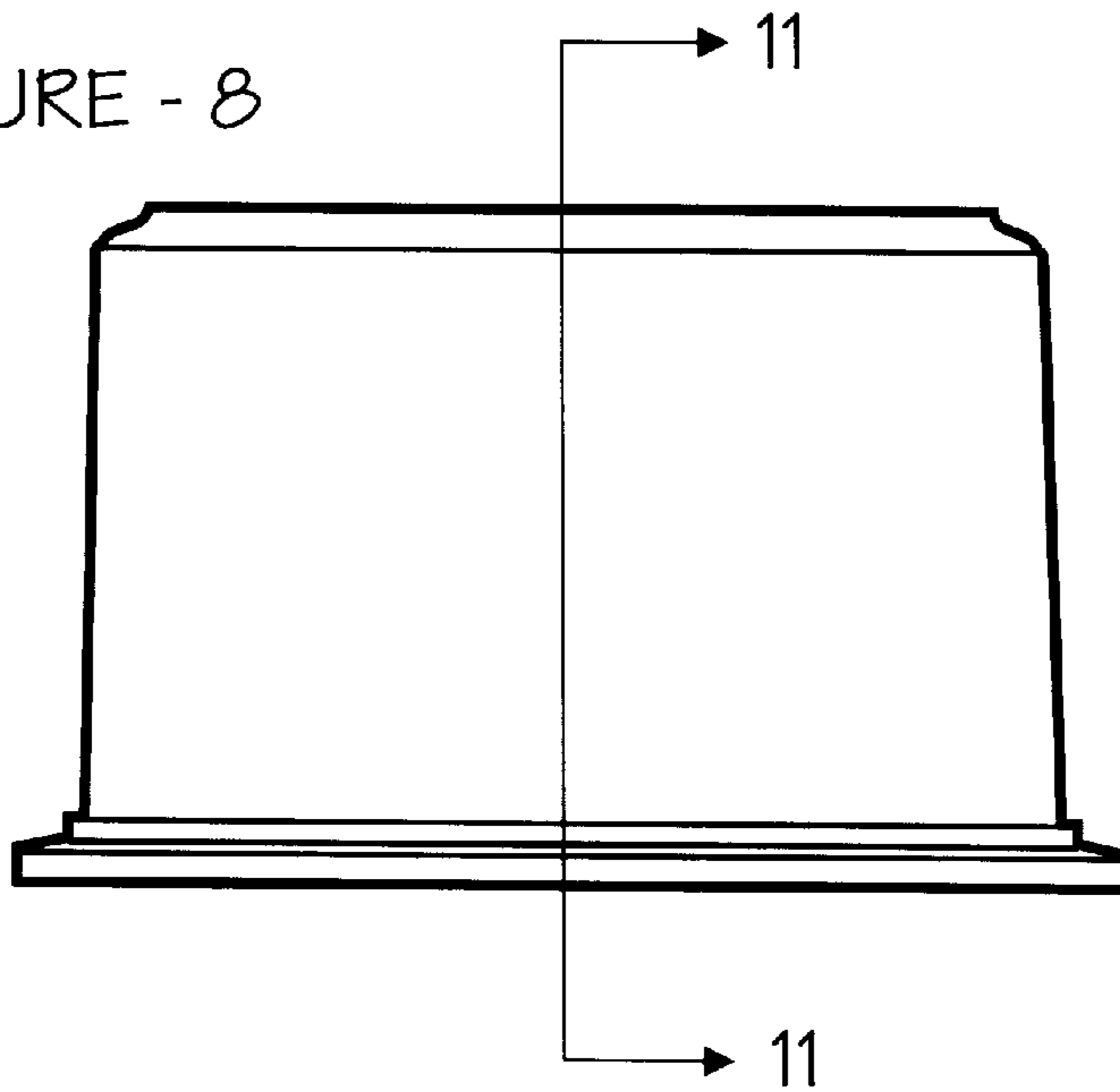

FIGURE - 11

FIGURE - 12

