



US00D440013S

(12) **United States Design Patent**
Newman

(10) **Patent No.:** **US D440,013 S**

(45) **Date of Patent:** **** Apr. 3, 2001**

(54) **RETRACTABLE NAIL FILE**

2,785,691 * 3/1957 Anderson 132/72.6

(76) Inventor: **Karla Newman**, 921 Ashley Glen Dr.,
Winston-Salem, NC (US) 27104

* cited by examiner

(**) Term: **14 Years**

Primary Examiner—Dominic Simone
(74) *Attorney, Agent, or Firm*—Charles Y. Lackey;
Kilpatrick Stockton LLP

(21) Appl. No.: **29/105,202**

(57) **CLAIM**

(22) Filed: **May 20, 1999**

The ornamental design for a retractable nail file, as shown
and described.

(51) **LOC (7) Cl.** **28-02**

(52) **U.S. Cl.** **D28/59; D8/100**

(58) **Field of Search** D28/56, 59; D8/99,
D8/100, 105; 30/156, 162; 132/76.4

DESCRIPTION

(56) **References Cited**

U.S. PATENT DOCUMENTS

D. 307,106	*	4/1990	Krebs	D8/99
D. 331,643	*	12/1992	Lunderman et al.	D28/59
D. 373,946	*	9/1996	Sawano	D8/99
D. 394,129	*	5/1998	Litton	D28/59
D. 399,404	*	10/1998	Gullete	D8/100
2,284,168	*	5/1942	Rickenbacher	132/76.2
2,408,888	*	10/1946	Shoop	132/76.2
2,555,360	*	6/1951	Murpyy	132/76.2

FIG. 1 is a left side elevational view of a retractable nail file
showing my new design;
FIG. 2 is a top plan view thereof;
FIG. 3 is a right side elevational view thereof;
FIG. 4 is a front elevational view thereof, the rear being
identical;
FIG. 5 is a bottom plan view thereof;
FIG. 6 is a top plan view thereof, the blade in an extended
position;
FIG. 7 is front elevational view of FIG. 6; and,
FIG. 8 is a front, left perspective view of FIG. 6.

1 Claim, 2 Drawing Sheets

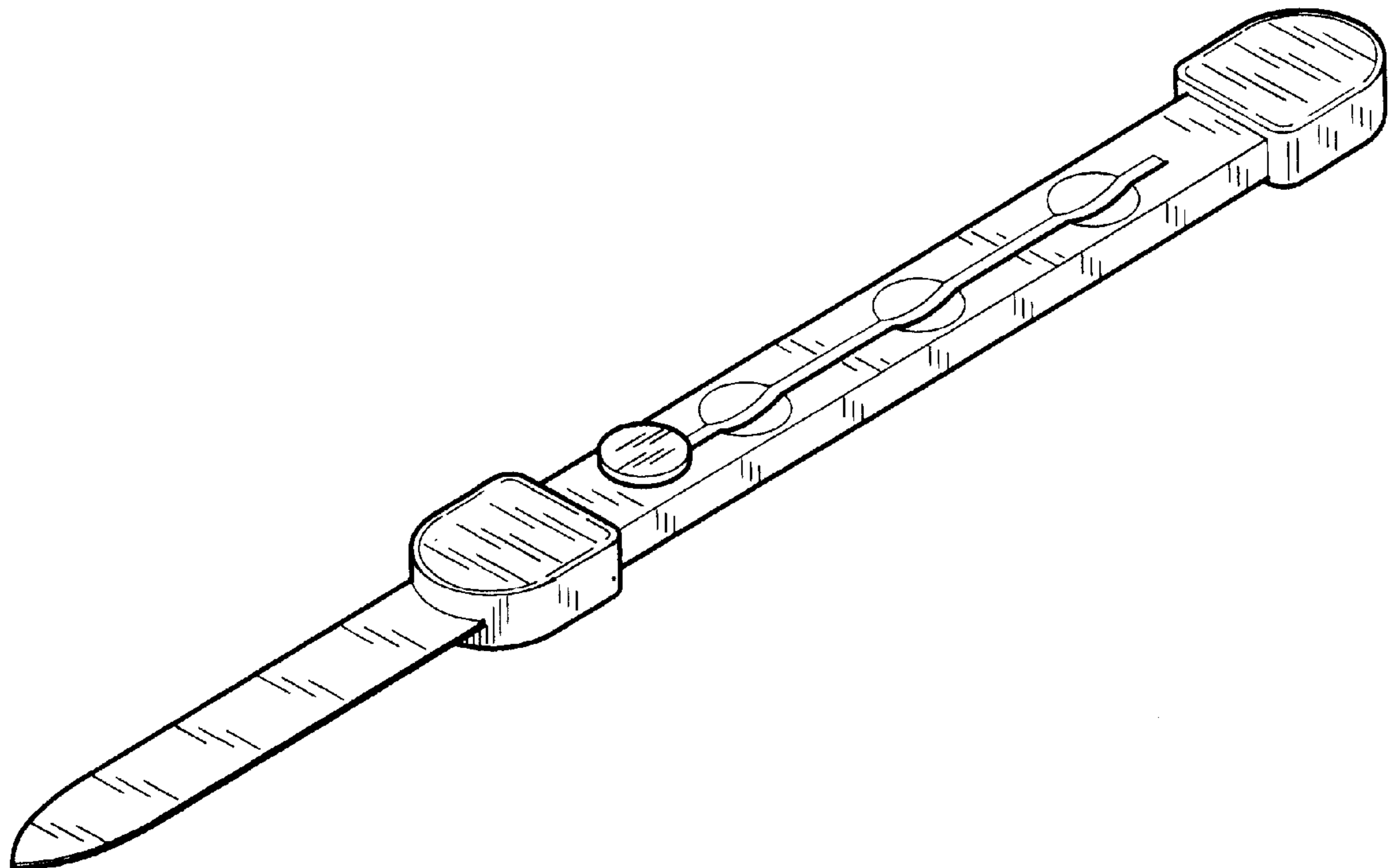

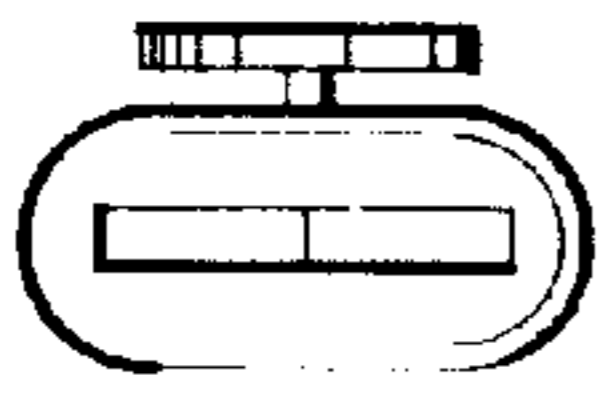

Fig. 1

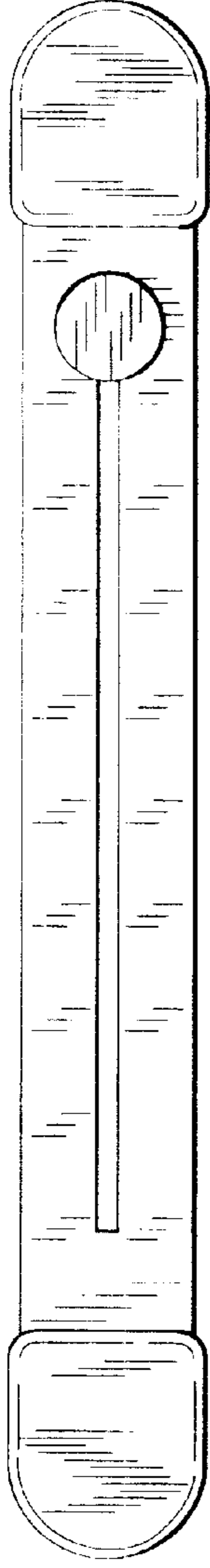

Fig. 2



Fig. 3

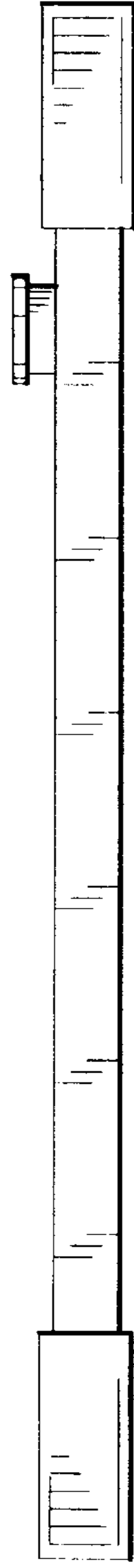

Fig. 4

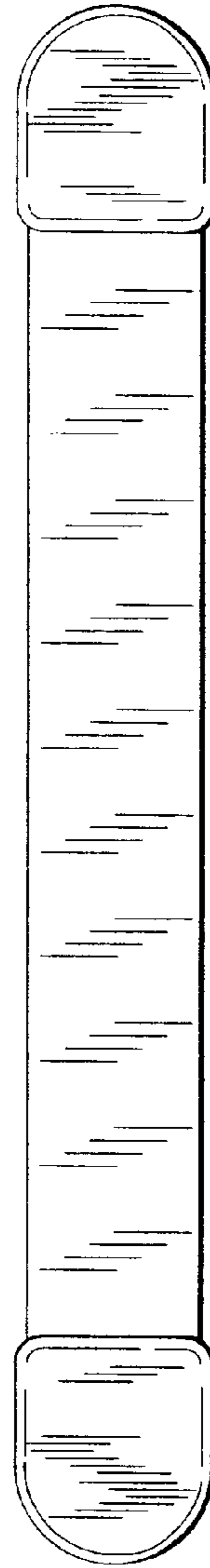

Fig. 5

Fig. 6

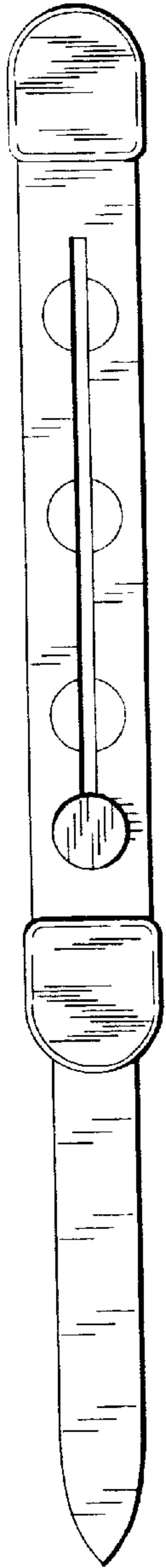

Fig. 7

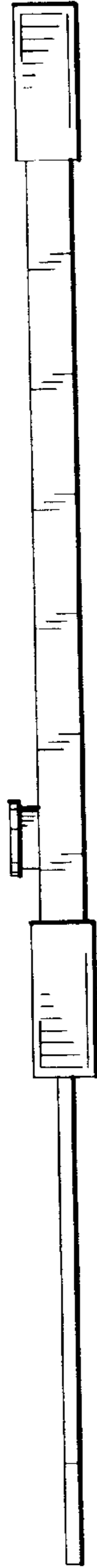

Fig. 8

