



US00D439989S

(12) **United States Design Patent**
Winters

(10) **Patent No.:** **US D439,989 S**

(45) **Date of Patent:** **** Apr. 3, 2001**

(54) **CONCRETE CONSTRUCTION BLOCK**

2,313,363 * 3/1943 Schmitt D25/113 X
3,060,542 * 10/1962 Martin 52/596
3,739,541 * 6/1973 Andrews 52/275 X

(75) Inventor: **Gerald D. Winters**, Jonesboro, AR
(US)

* cited by examiner

(73) Assignee: **Nettleton Concrete Works, Inc.**,
Jonesboro, AR (US)

Primary Examiner—Louis S. Zarfaz
Assistant Examiner—Robert A. Delehanty
(74) *Attorney, Agent, or Firm*—Stephen D. Carver

(**) Term: **14 Years**

(57) **CLAIM**

(21) Appl. No.: **29/117,759**

The ornamental design for concrete construction block, as shown and described.

(22) Filed: **Feb. 1, 2000**

(51) **LOC (7) Cl.** **25-01**

DESCRIPTION

(52) **U.S. Cl.** **D25/113; D25/118**

(58) **Field of Search** D25/113–118,
D25/199, 62–63, 68; D21/484–485, 490–493,
499–505; 52/609–610, 574, 575, 596; 404/37–39,
34, 40–42, 50; 405/289–286

FIG. 1 is a frontal isometric view of a preferred embodiment of my new concrete construction block;
FIG. 2 is a front plan view of the preferred embodiment;
FIG. 3 is a top plan view of the preferred embodiment;
FIG. 4 is a left end elevational view of the preferred embodiment, the opposite end comprising a mirror image;
FIG. 5 is a bottom plan view of the preferred embodiment;
and,
FIG. 6 is a frontal isometric view of a second embodiment of my new concrete construction block, the front plan view and the left end elevational views of said second embodiment corresponding to FIGS. 2 and 4 respectively.

(56) **References Cited**

U.S. PATENT DOCUMENTS

D. 192,734 * 5/1962 Terry D25/118
D. 408,930 * 4/1999 Behunin D25/114
1,287,055 * 12/1918 Lehman 52/609
1,789,400 * 1/1931 Brozek 52/610
2,137,153 * 11/1938 Brozek 52/574
2,184,682 * 12/1939 Sentrop D25/116 X

1 Claim, 6 Drawing Sheets

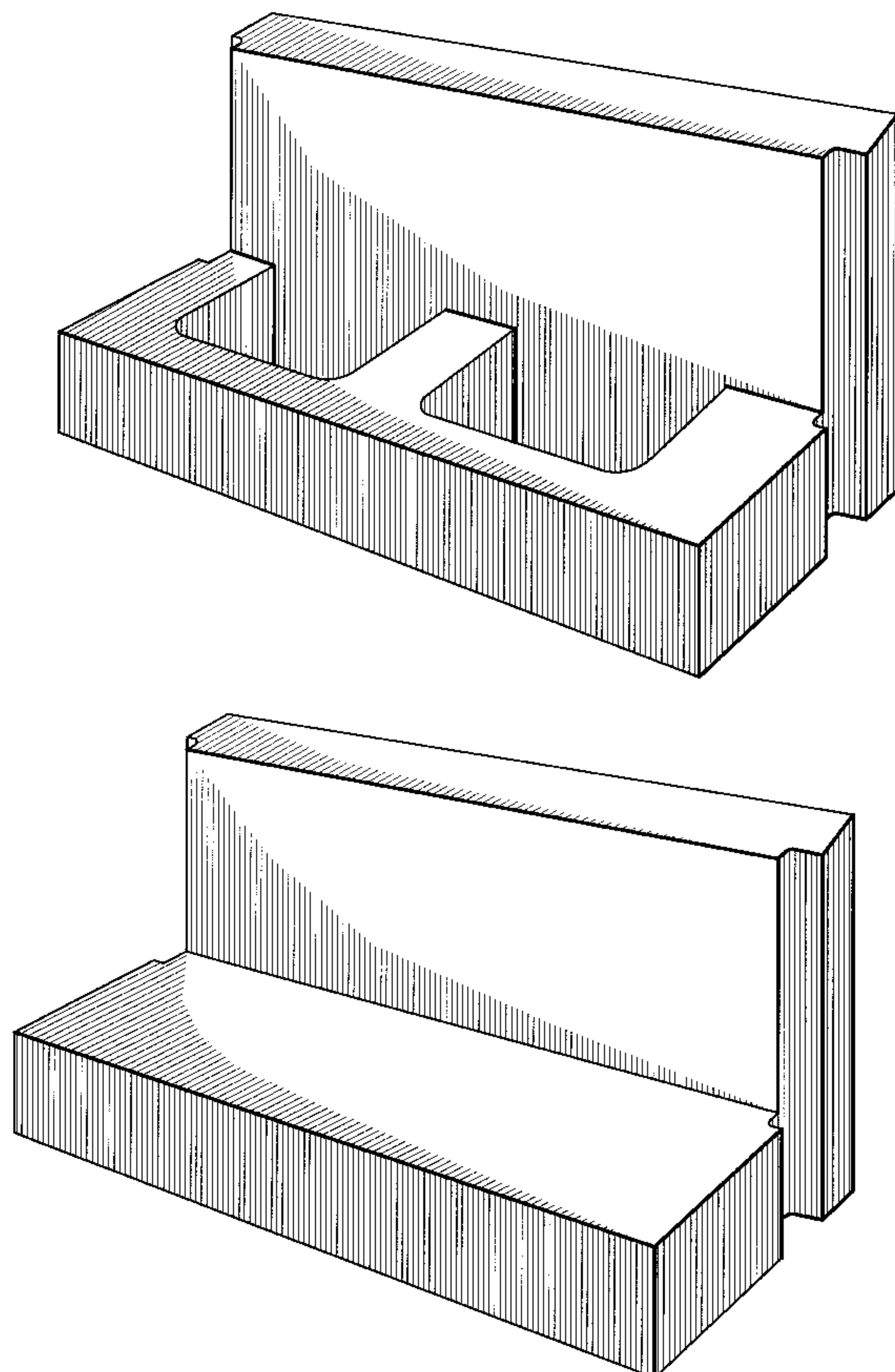

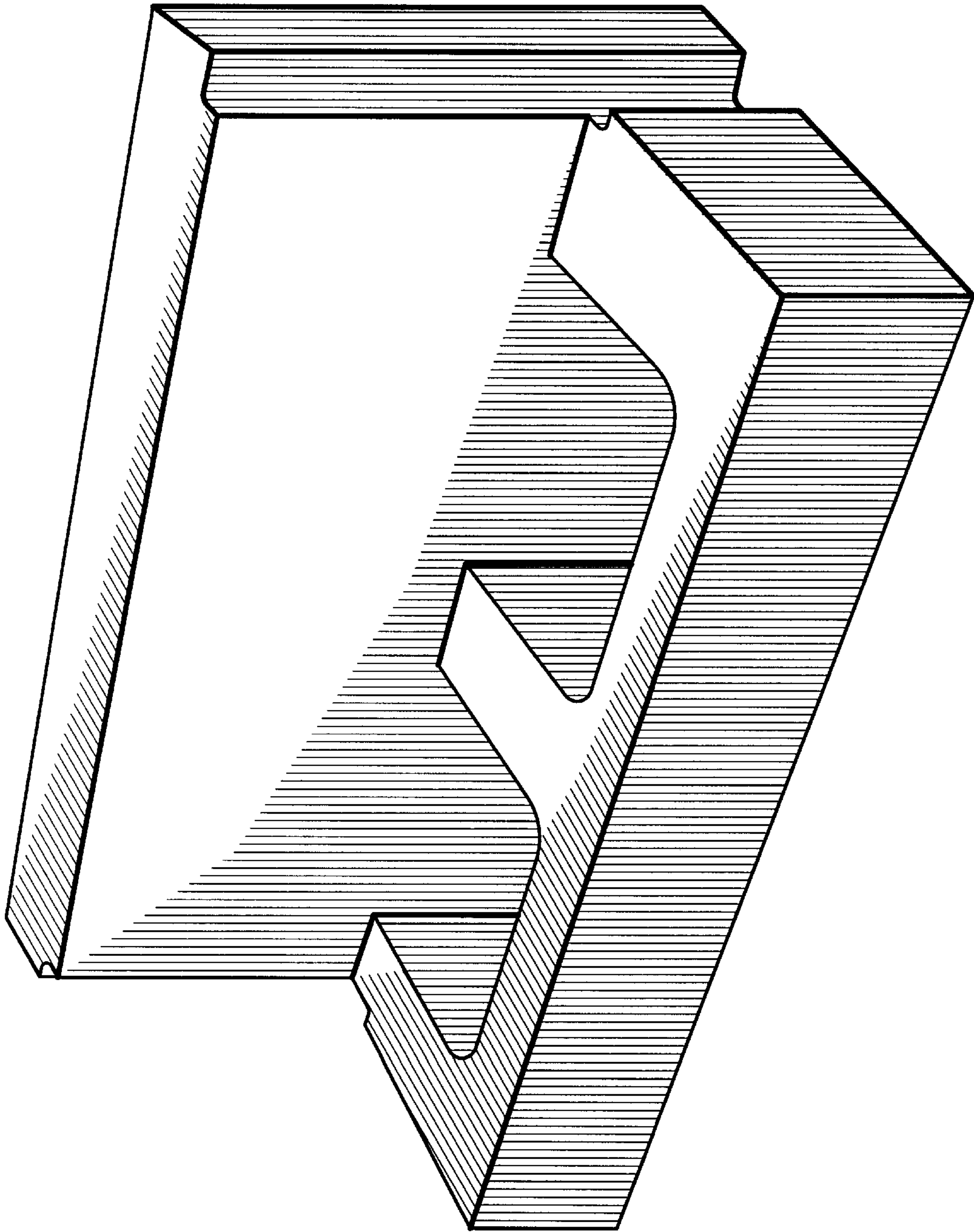

Fig. 1

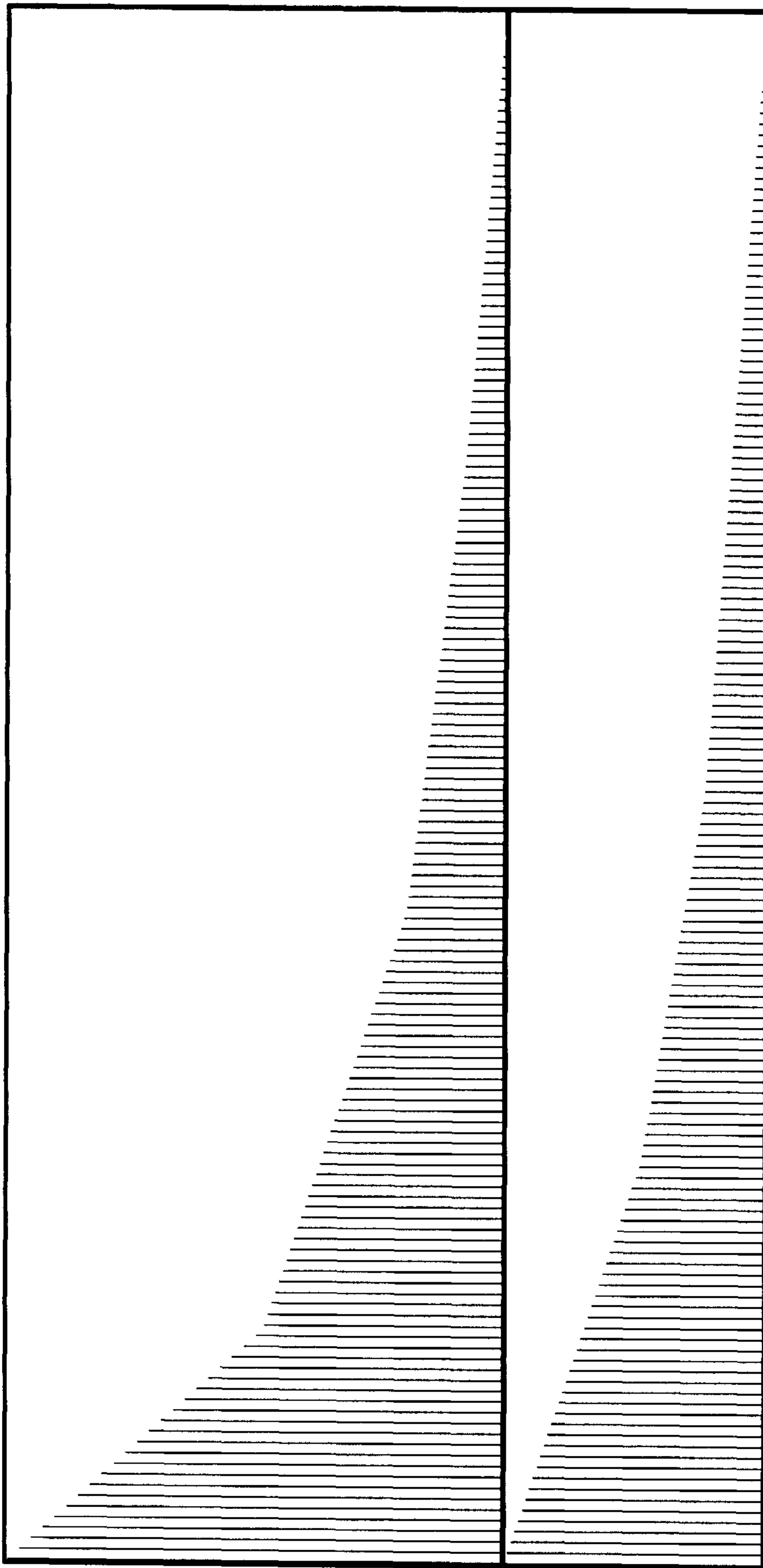

FIG. 2

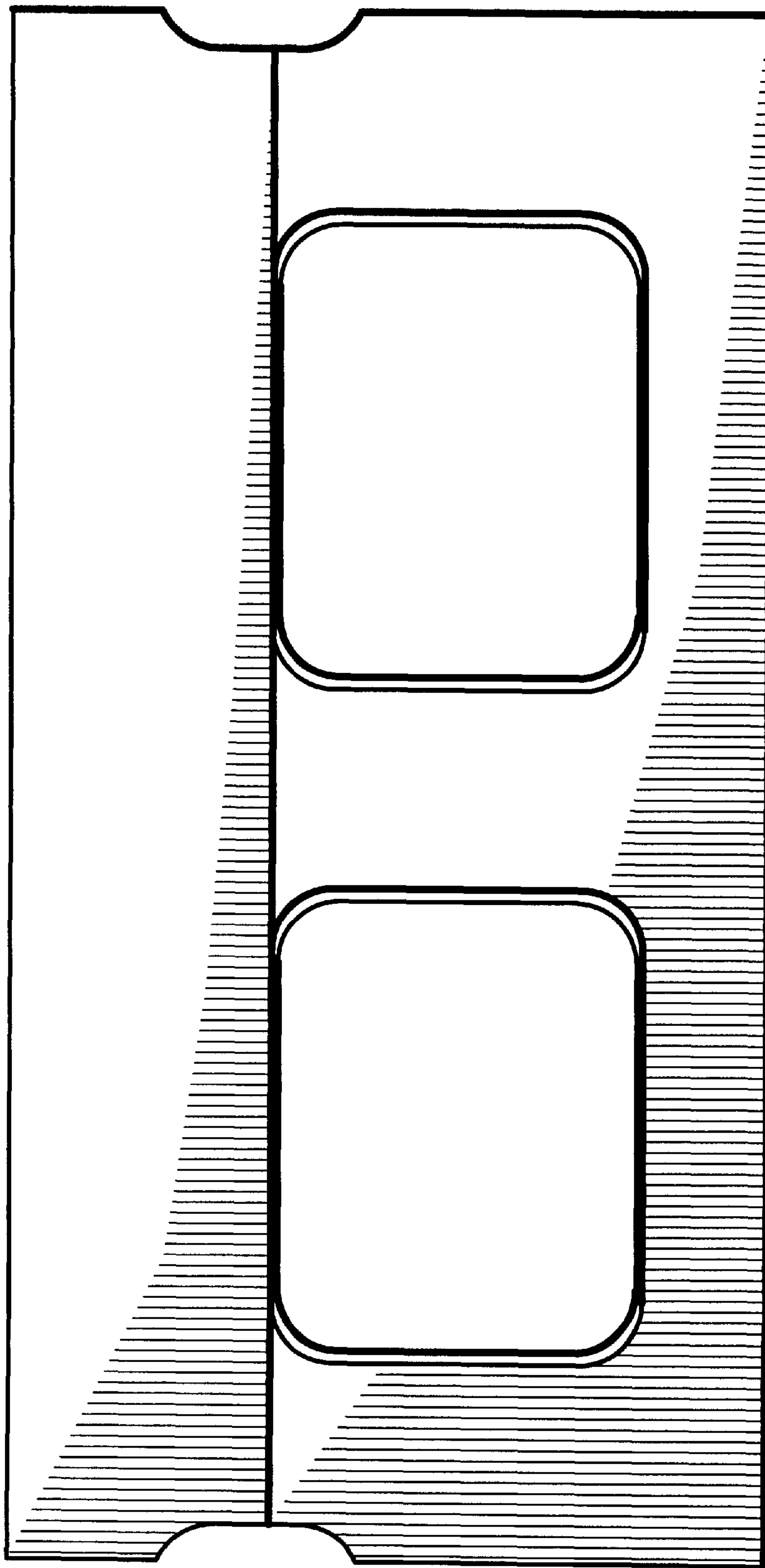

FIG. 3

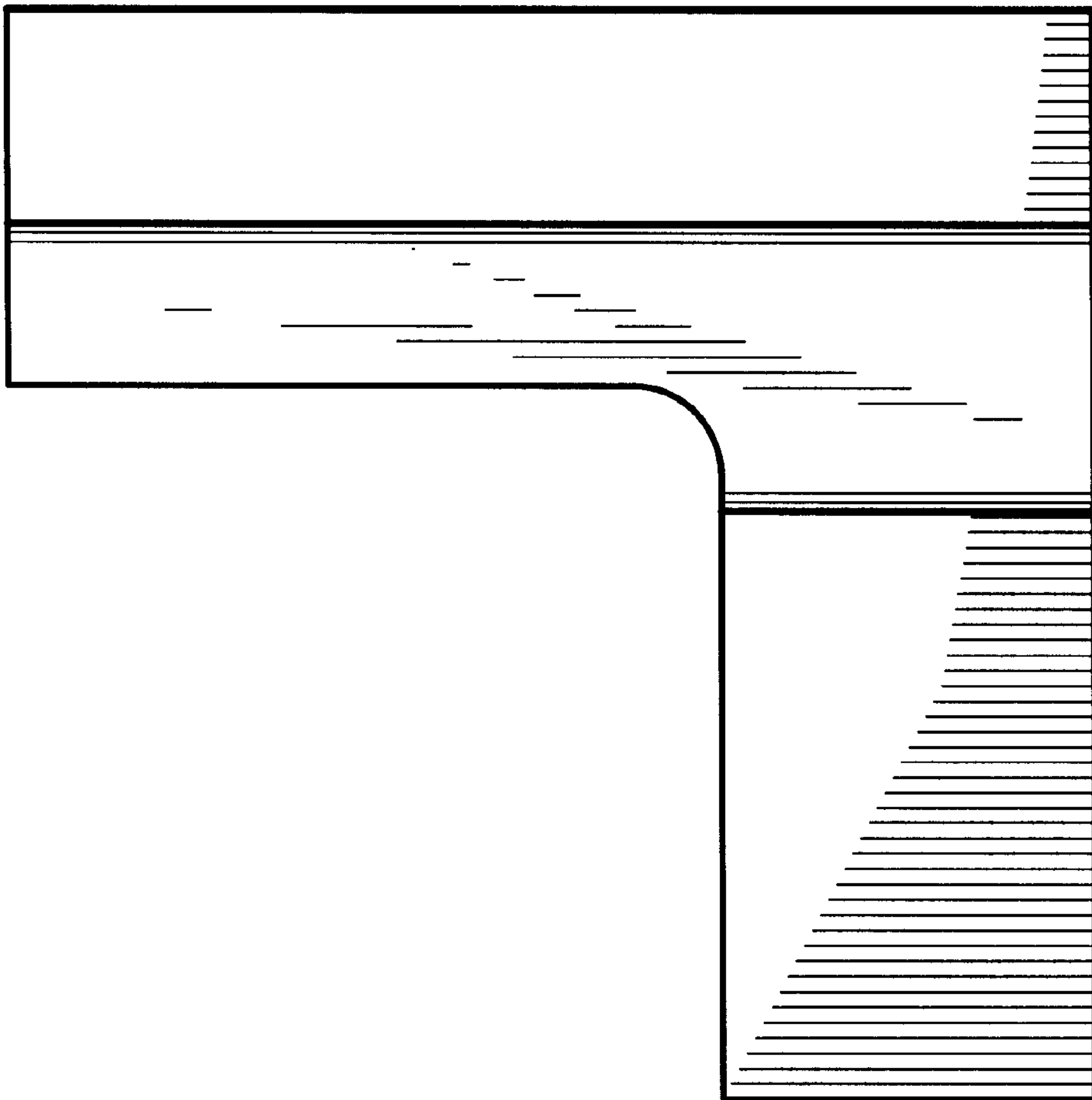

FIG. 4

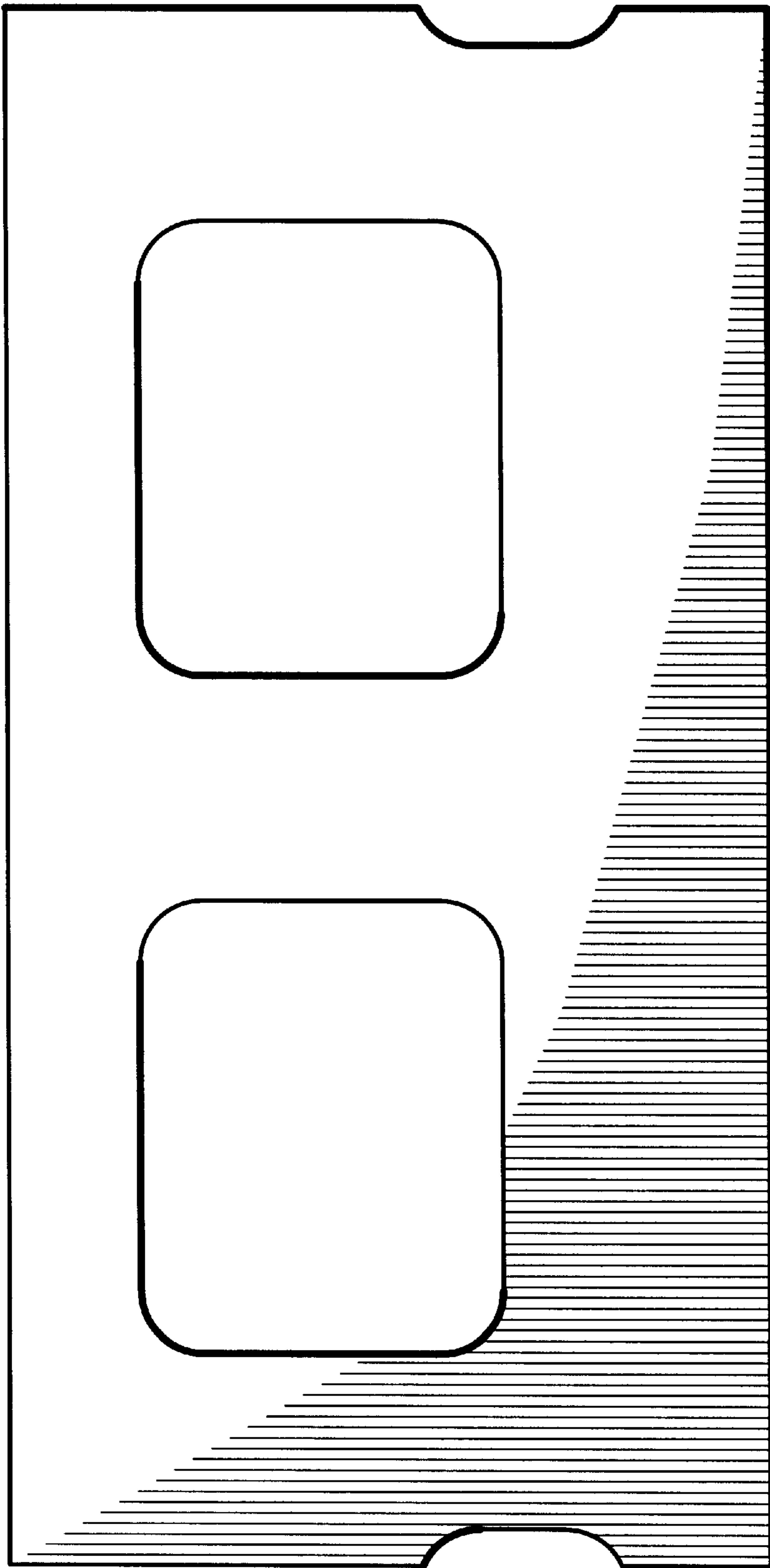

FIG. 5

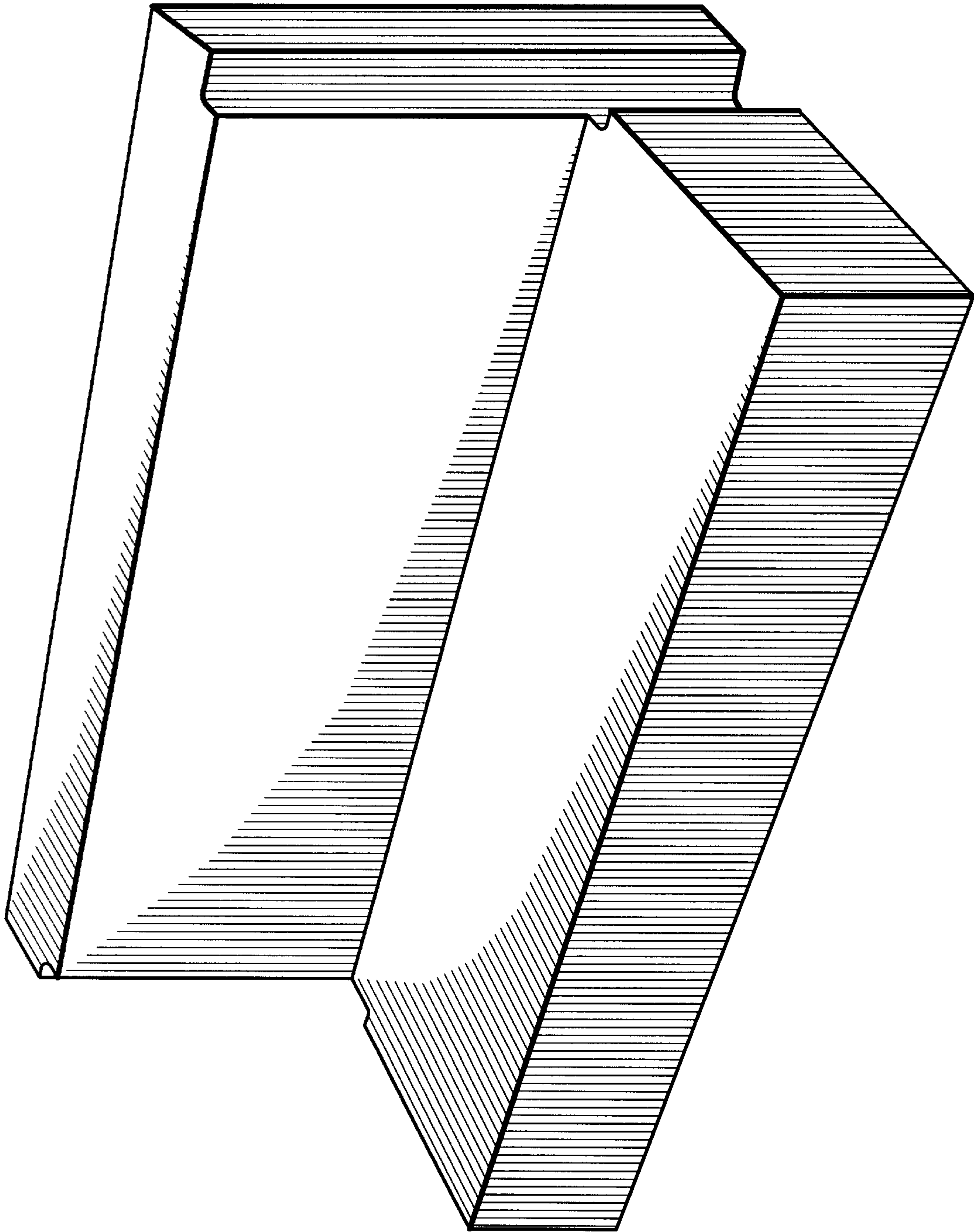

FIG. 6