



US00D439892S

(12) **United States Design Patent**
Tal et al.

(10) **Patent No.:** **US D439,892 S**

(45) **Date of Patent:** **** Apr. 3, 2001**

(54) **CONFERENCE CALL APPARATUS**

(75) Inventors: **Elisha Tal**, Maccabim; **Danny Lavie**,
Ramat Hasharon, both of (IL)

(73) Assignee: **Vcon Telecommunications Ltd.**,
Herzliya (IL)

(**) Term: **14 Years**

(21) Appl. No.: **29/121,555**

(22) Filed: **Apr. 7, 2000**

(30) **Foreign Application Priority Data**

Mar. 22, 2000 (IL) 33272

(51) **LOC (7) Cl.** **14-03**

(52) **U.S. Cl.** **D14/243; D14/149; D14/227**

(58) **Field of Search** D14/137, 138,
D14/148, 147, 149-151, 140-142, 240,
241, 251, 253, 155, 159, 221, 225, 227,
210, 211, 212, 213, 214, 130, 243; 379/433-436,
419, 420, 428, 440, 454, 455, 446, 447;
348/13-17

(56) **References Cited**

U.S. PATENT DOCUMENTS

D. 197,610	*	3/1964	Miller	D14/227
D. 212,421	*	10/1968	Thiess	D14/130
D. 325,733	*	4/1992	Suzuki et al.	D14/155
D. 327,060	*	6/1992	Wachob et al.	D14/138
D. 335,497	*	5/1993	Patterson, Jr. et al.	D14/211
D. 343,231	*	1/1994	Lim	D23/336
D. 344,906	*	3/1994	Abrams et al.	D14/159
D. 350,956	*	9/1994	Sumikawa	D14/155
D. 364,871	*	12/1995	Esslinger	D14/213

D. 379,989	*	6/1997	Skene et al.	D14/214
D. 389,832	*	1/1998	Chong	D14/150
D. 391,574	*	3/1998	Chen	D14/211
D. 401,579	*	11/1998	Benjamin et al.	D14/149
D. 423,491	*	4/2000	Harris et al.	D14/130
4,078,155	*	3/1978	Botros et al.	379/420 X
5,808,663	*	9/1998	Okaya	348/15
5,896,461	*	4/1999	Faraci et al.	379/420 X

* cited by examiner

Primary Examiner—Jeffrey Asch

(74) *Attorney, Agent, or Firm*—Darby & Darby

(57) **CLAIM**

The ornamental design for a conference call apparatus, as shown and described.

DESCRIPTION

FIG. 1 is a perspective view of a conference call apparatus showing our new design;

FIG. 2 is a front view of the conference call apparatus shown in FIG. 1 with a perforated front area;

FIG. 3 is a back view of the conference call apparatus shown in FIG. 1;

FIG. 4 is a left side view of the conference call apparatus shown in FIG. 1;

FIG. 5 is a right side view of the conference call apparatus shown in FIG. 1;

FIG. 6 is a top view of the conference call apparatus shown in FIG. 1; and,

FIG. 7 is a perspective view of the conference call apparatus shown in FIG. 1, the broken line showing of a camera is for illustrative purposes only and forms no part of the claimed design.

1 Claim, 4 Drawing Sheets

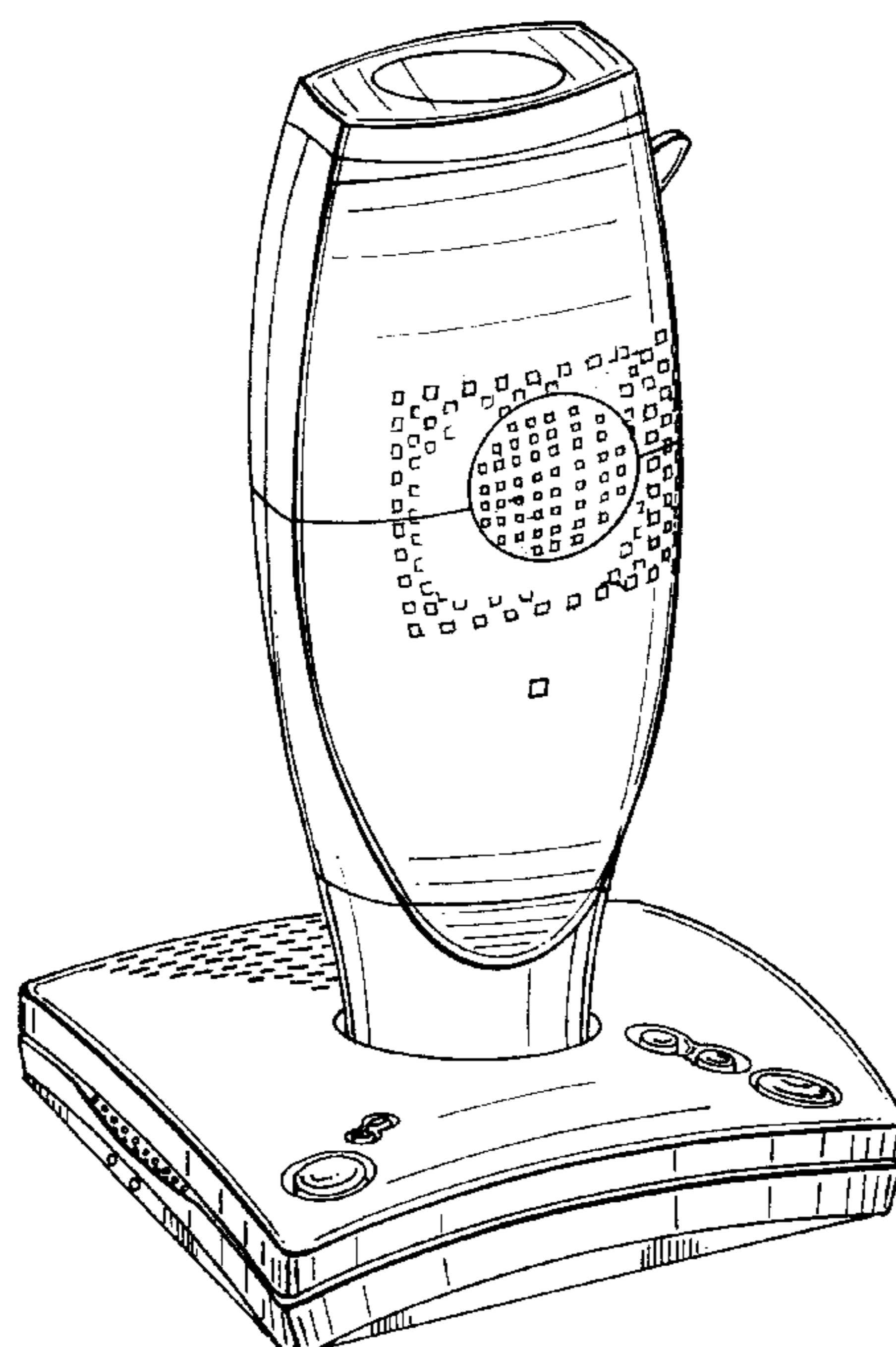

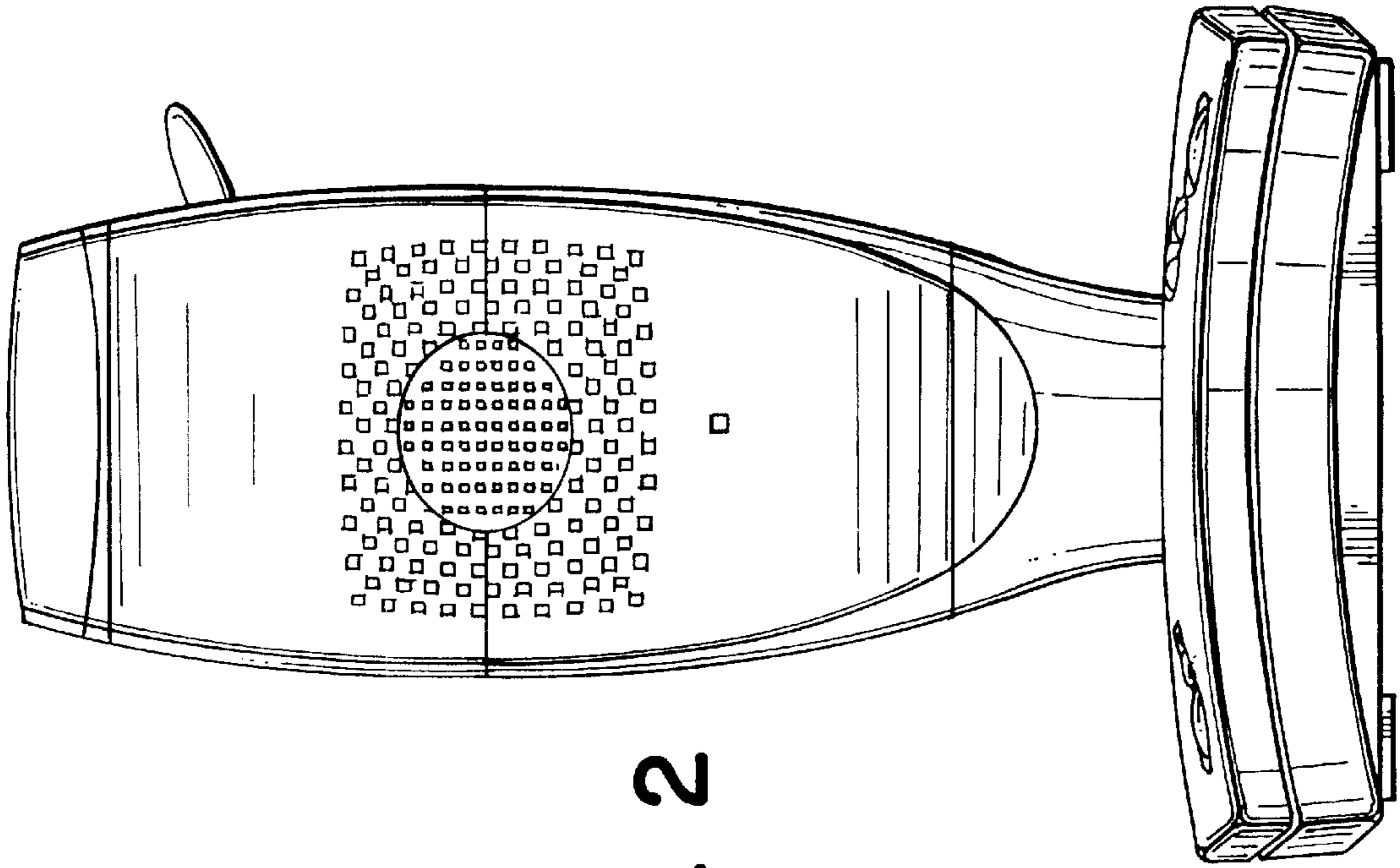

FIG. 2

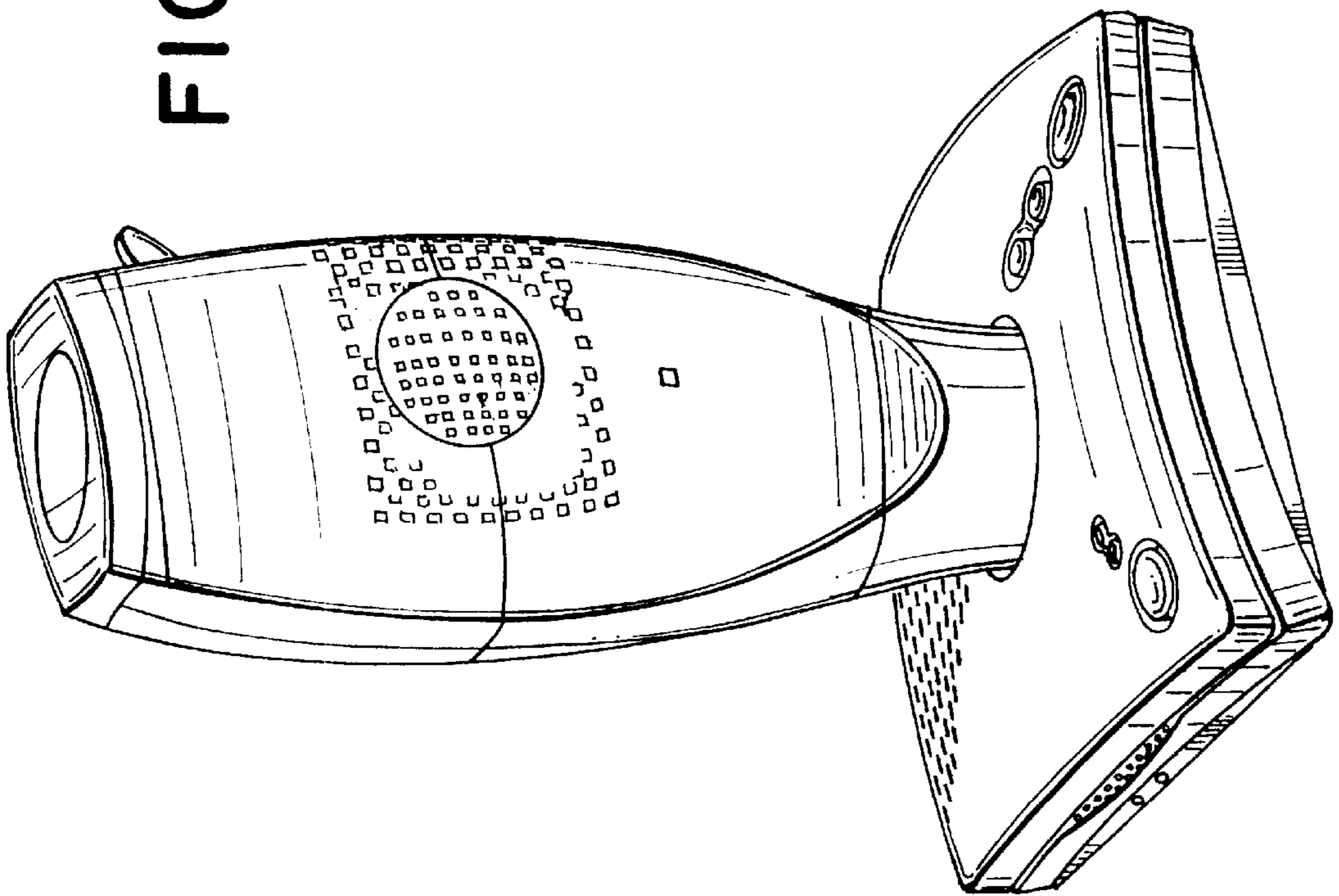

FIG. 1

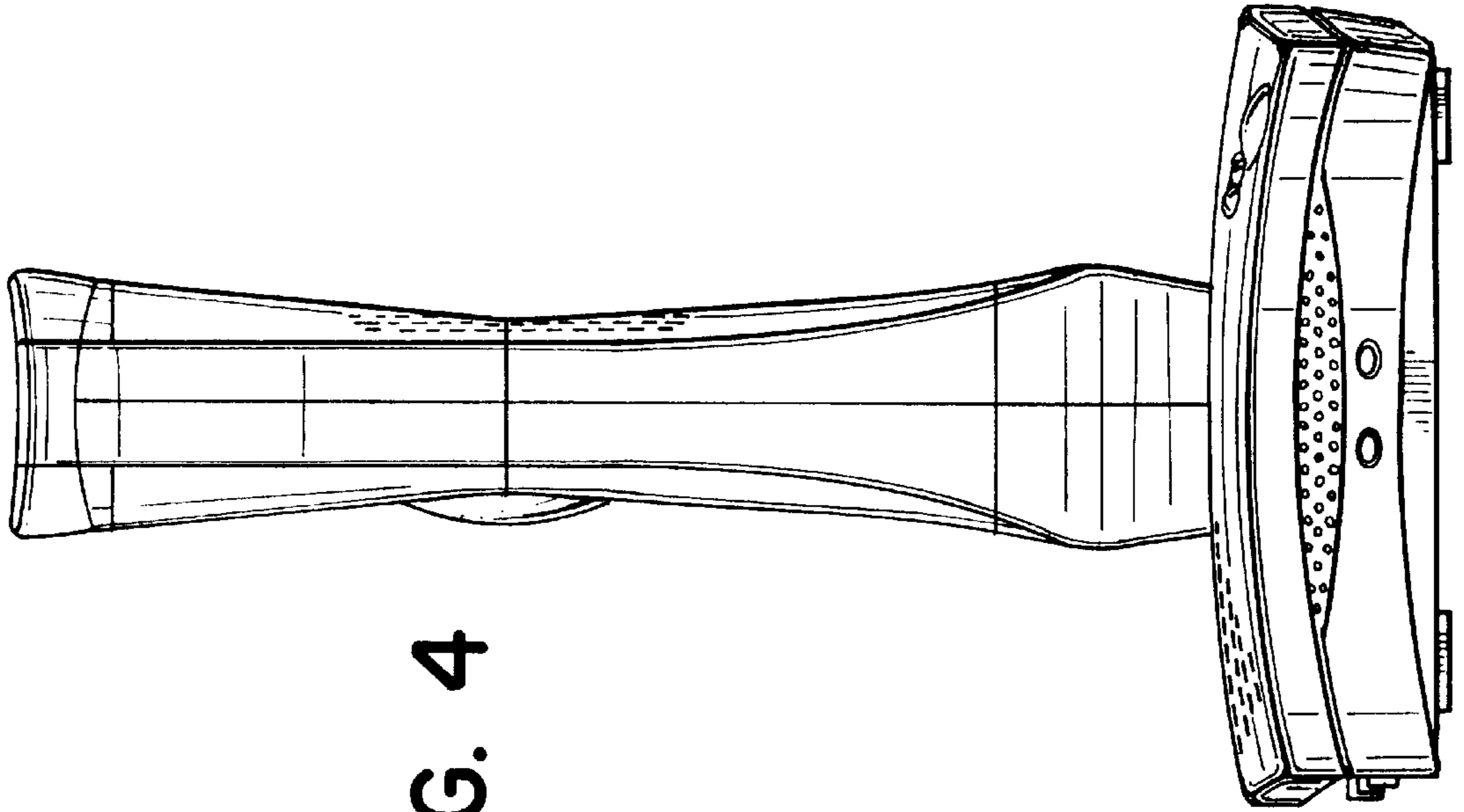

FIG. 4

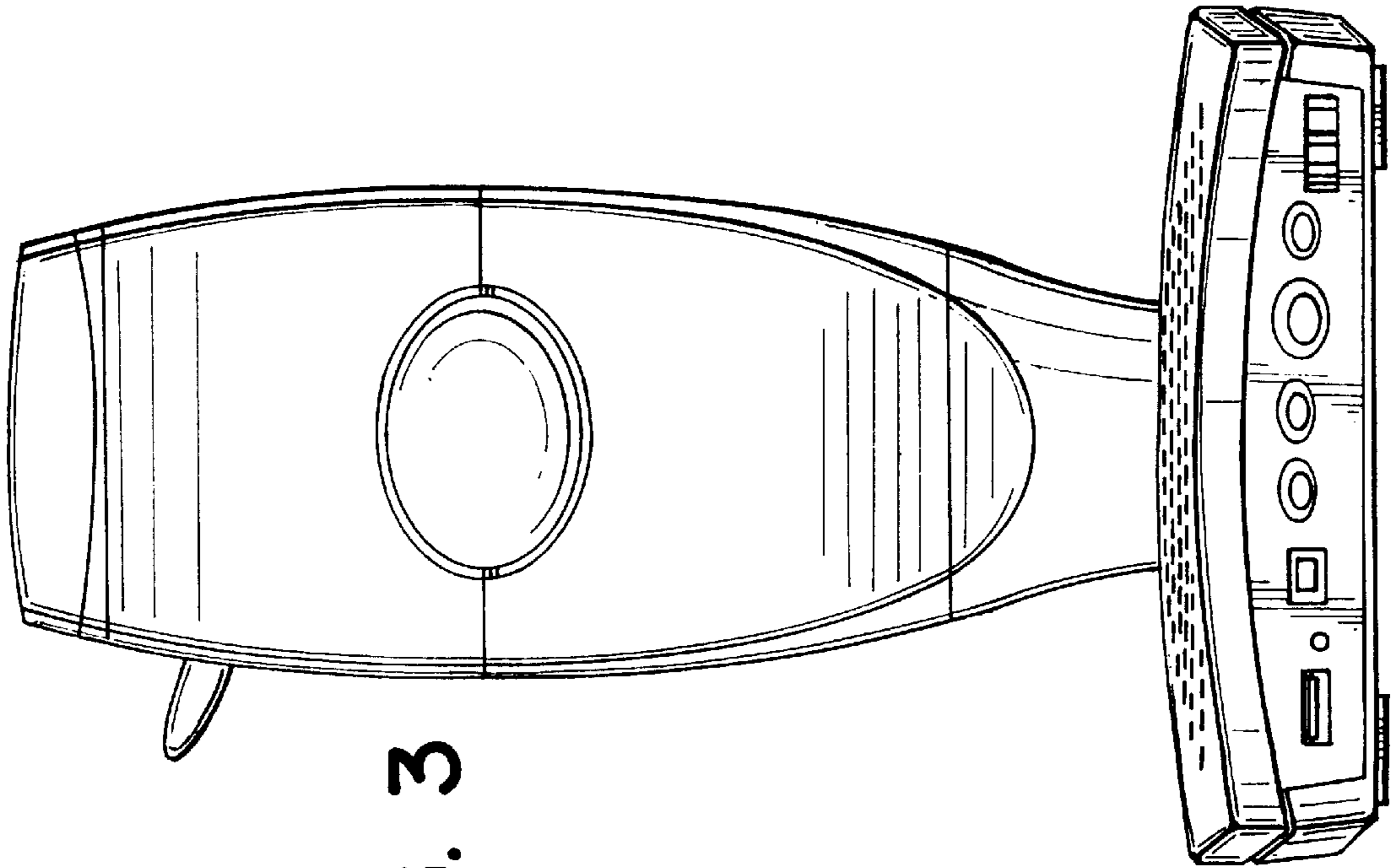

FIG. 3

FIG. 6

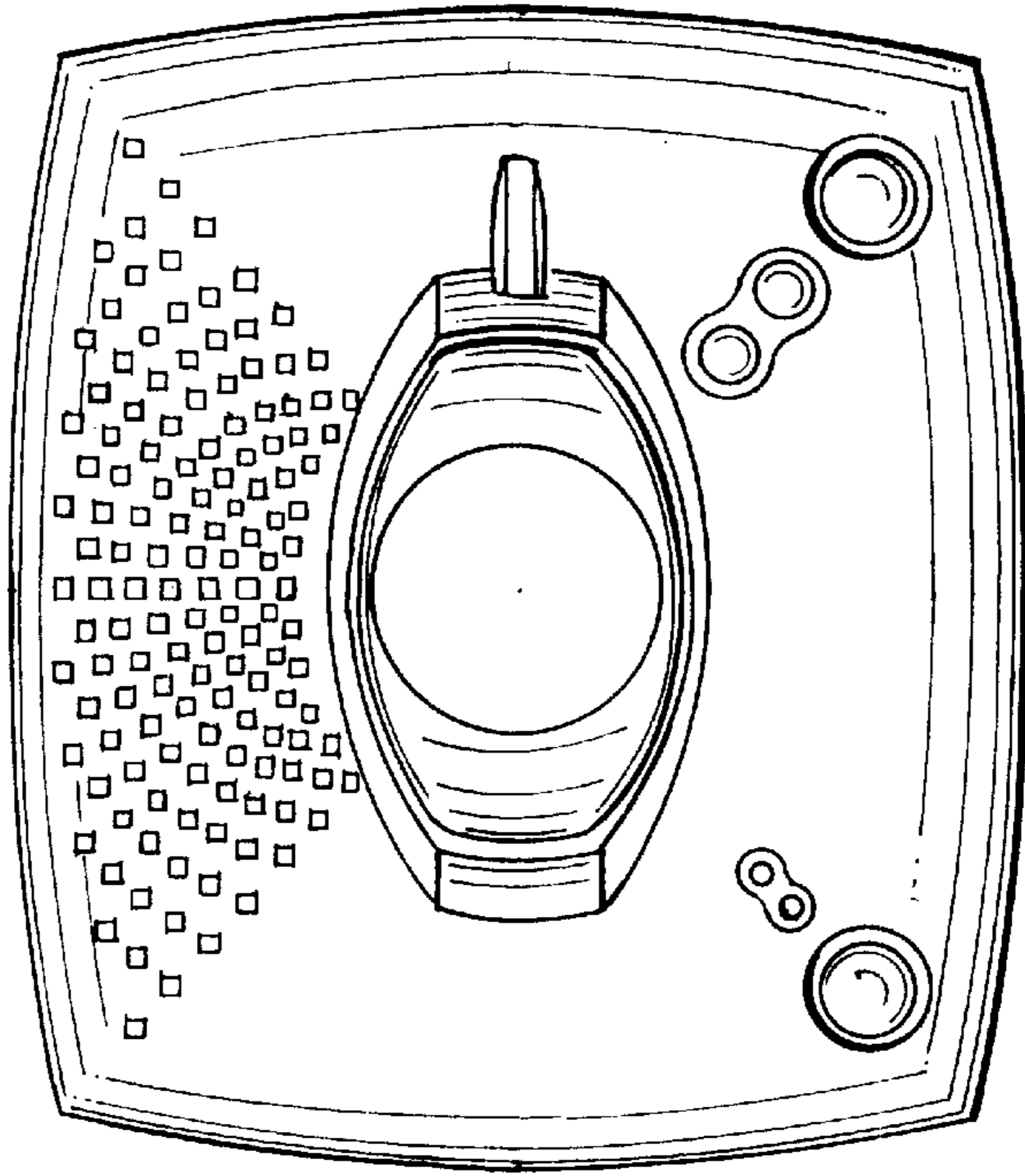

FIG. 5

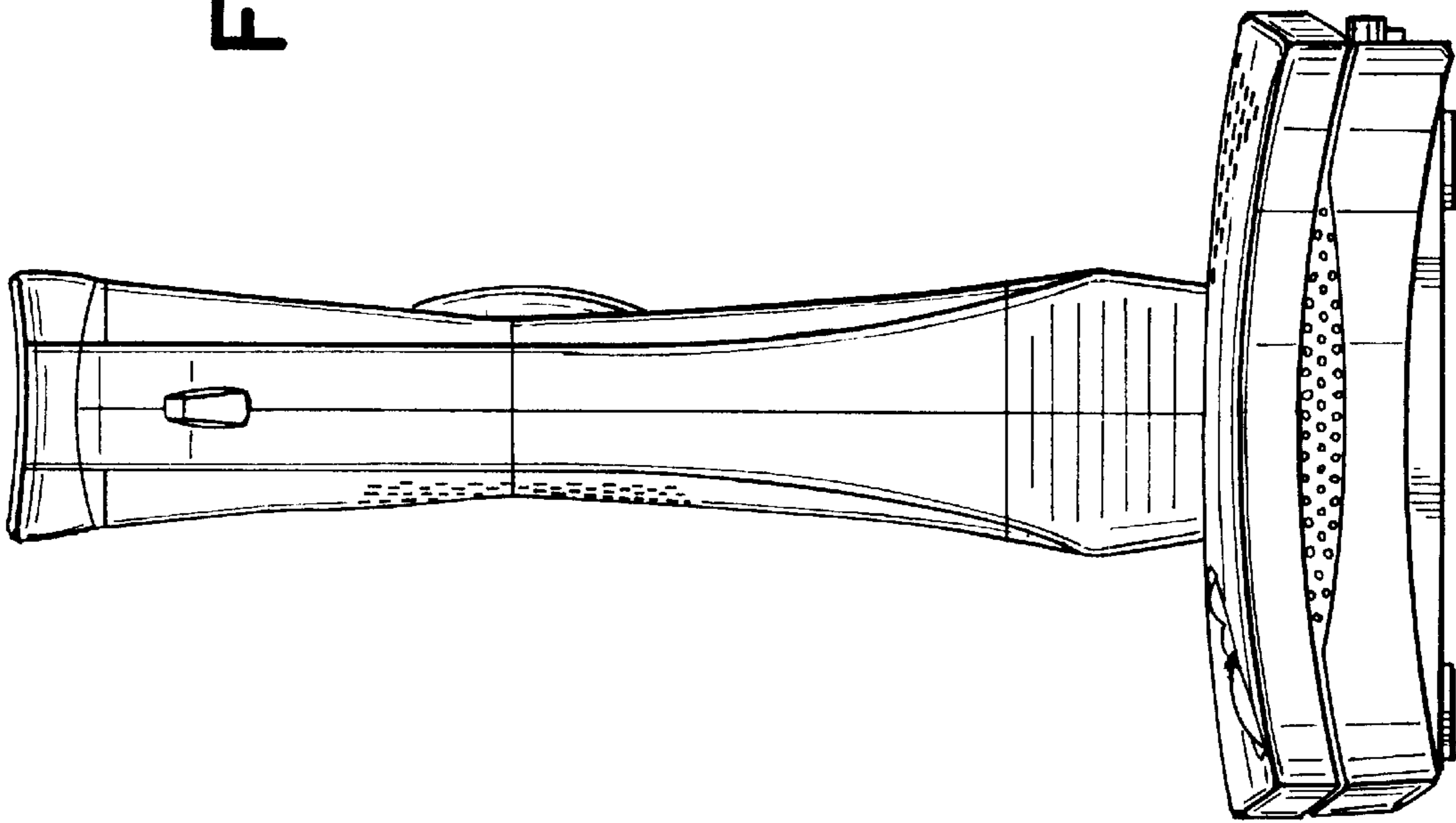

FIG. 7

