



US00D439756S

(12) **United States Design Patent**
Bigolin

(10) **Patent No.:** **US D439,756 S**

(45) **Date of Patent:** **** Apr. 3, 2001**

(54) **BICYCLE SADDLE**

DESCRIPTION

(75) **Inventor:** **Riccardo Bigolin**, San Zenono Degli Ezzelini (IT)

(73) **Assignee:** **Selle Royal S.p.a.**, Pozzoleone (IT)

(**) **Term:** **14 Years**

(21) **Appl. No.:** **29/104,928**

(22) **Filed:** **May 13, 1999**

(51) **LOC (7) Cl.** **06-01**

(52) **U.S. Cl.** **D6/354**

(58) **Field of Search** D6/354; 297/195, 297/195.11, 195.12, 214, 219.11, 201, 202

(56) **References Cited**

U.S. PATENT DOCUMENTS

D. 306,378	*	3/1990	Bernardi	D6/357
D. 333,041	*	2/1993	Choi et al.	D6/354
D. 384,828	*	10/1997	Mel	D6/354
4,218,090	*	8/1980	Hoffocker et al.	297/214
5,165,752	*	11/1992	Terry	297/214
5,911,475	*	6/1999	Nakahara	297/219.11

* cited by examiner

Primary Examiner—Melody N. Brown

(74) *Attorney, Agent, or Firm*—Dykema Gossett PLLC

(57) **CLAIM**

The ornamental design for a bicycle saddle, as shown and described.

FIG. 1 is a top view of a first embodiment of a bicycle saddle according to the invention;

FIG. 2. is a left side elevation view of the bicycle saddle shown in FIG. 1;

FIG. 3 is a front elevation view of the bicycle saddle shown in FIG. 1;

FIG. 4 is a rear elevation view of the bicycle saddle shown in FIG. 1;

FIG. 5 is a bottom view of the bicycle saddle shown in FIG. 1;

FIG. 6 is a right side elevation view of the bicycle saddle shown in FIG. 1;

FIG. 7 is a top plan view of a second embodiment of a bicycle saddle according to the invention;

FIG. 8 is a left side elevation view of the saddle shown in FIG. 7;

FIG. 9 is a front elevation view of the bicycle saddle shown in FIG. 7;

FIG. 10. is a rear elevation view of the bicycle saddle shown in FIG. 7;

FIG. 11 is a bottom view of the bicycle saddle shown in FIG. 7;

FIG. 12 is a right side elevation view of the bicycle saddle shown in FIG. 7;

FIG. 13 is a rear elevation view of a third embodiment of a bicycle saddle according to the invention; and,

FIG. 14 is a bottom view of the bicycle saddle shown in FIG. 13.

The broken lines shown in FIGS. 2–6 are for illustrative purposes only and form no part of the claimed design.

The top, front and right side views of the third embodiment are the same as in the first and second embodiments.

1 Claim, 7 Drawing Sheets

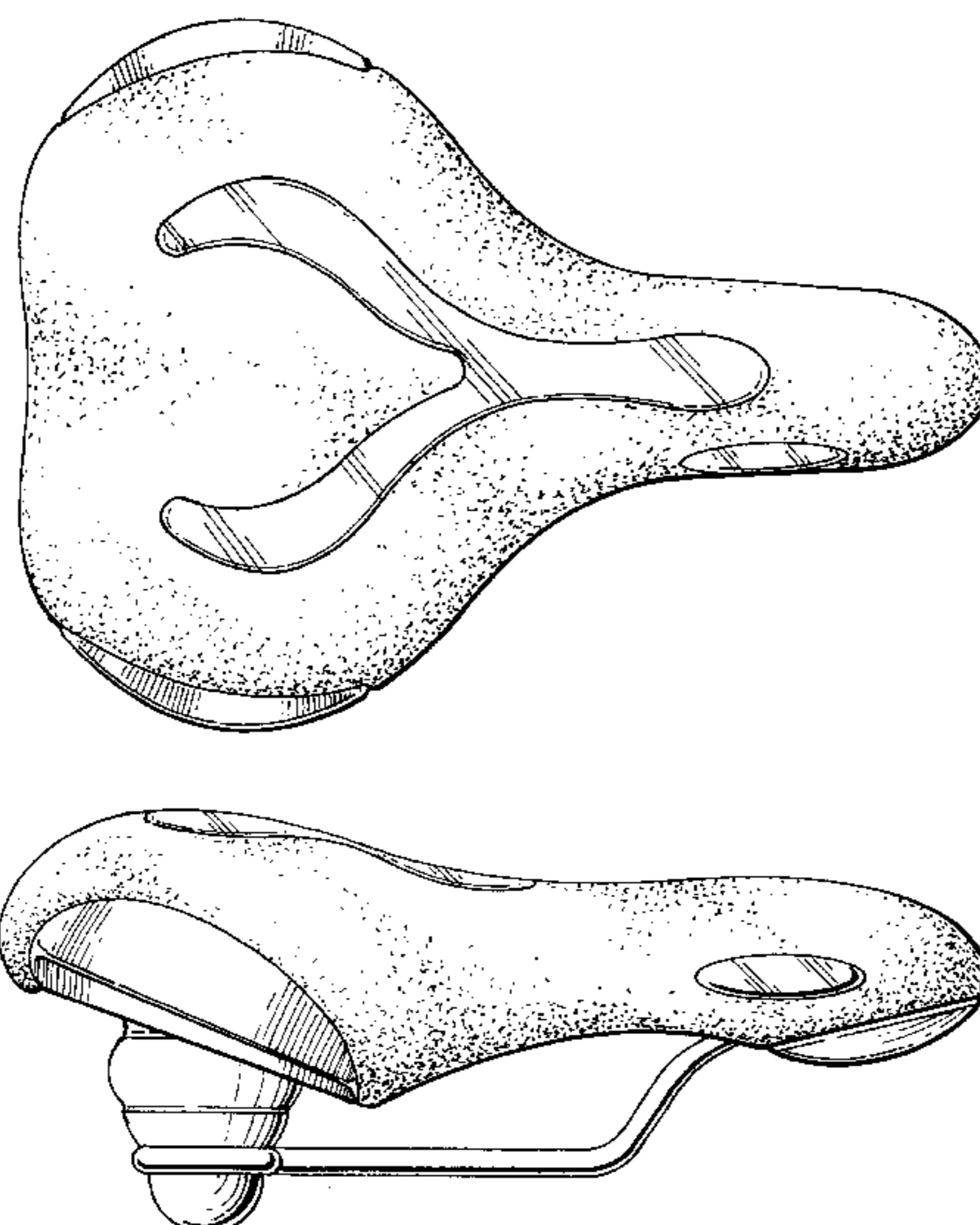

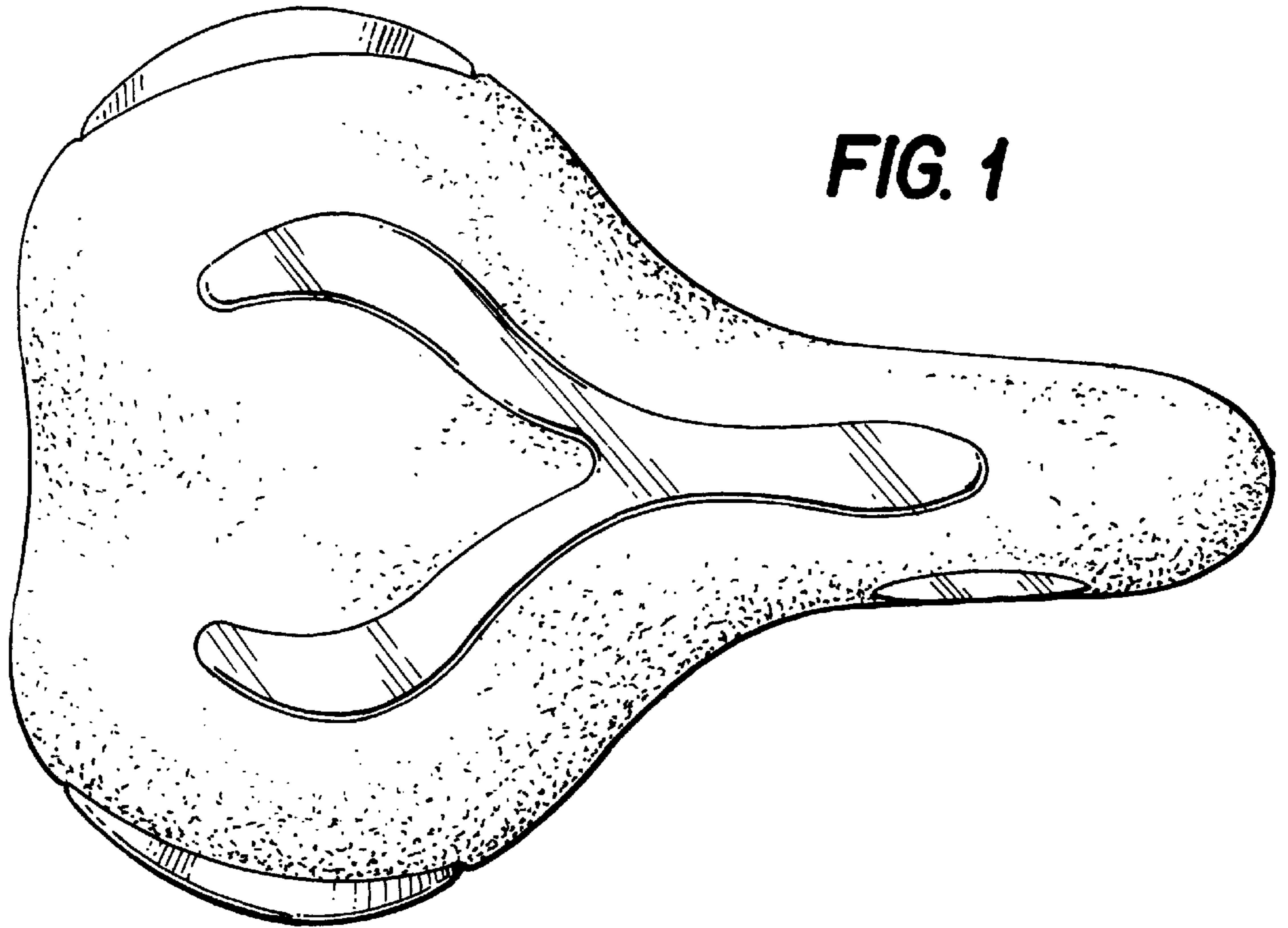
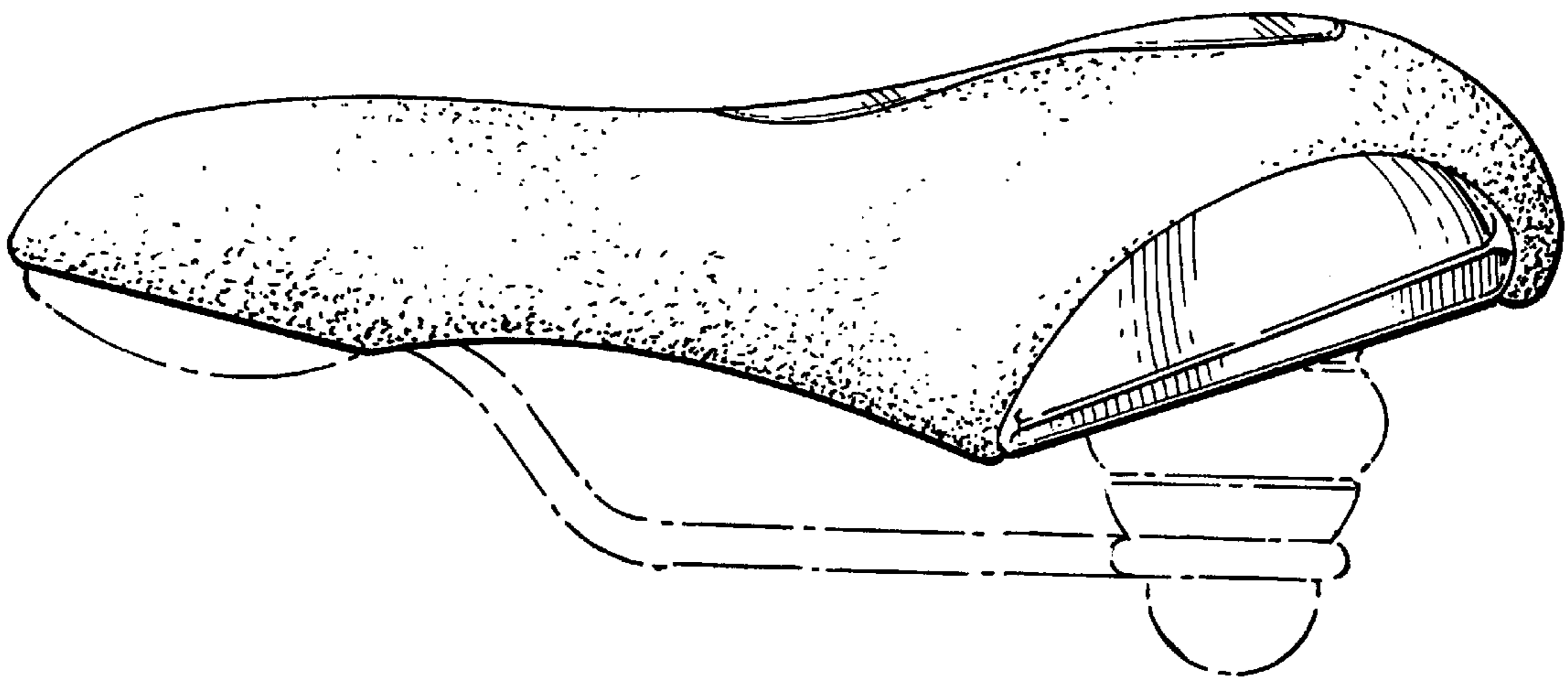

FIG. 1

FIG. 2



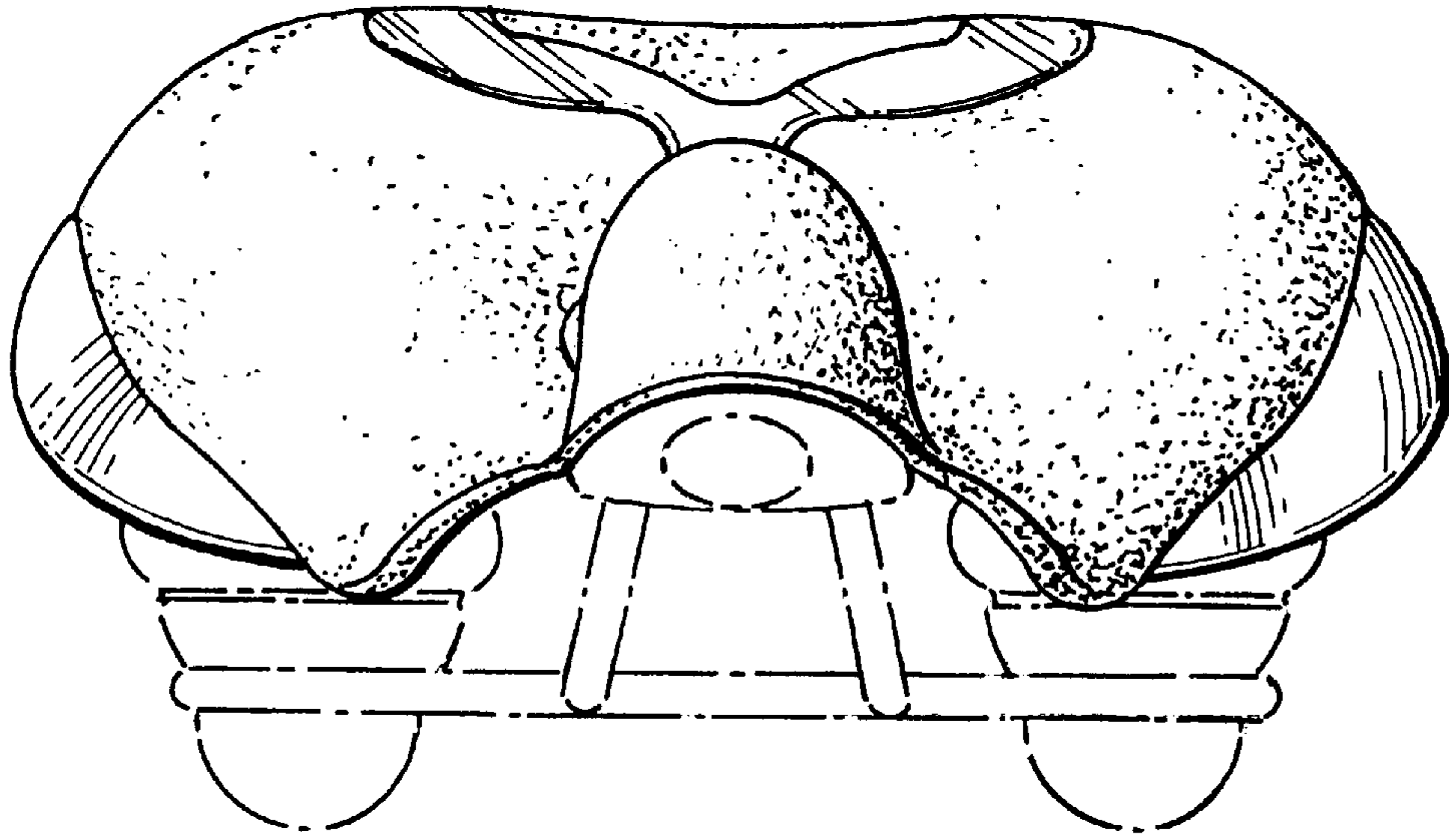

FIG. 3

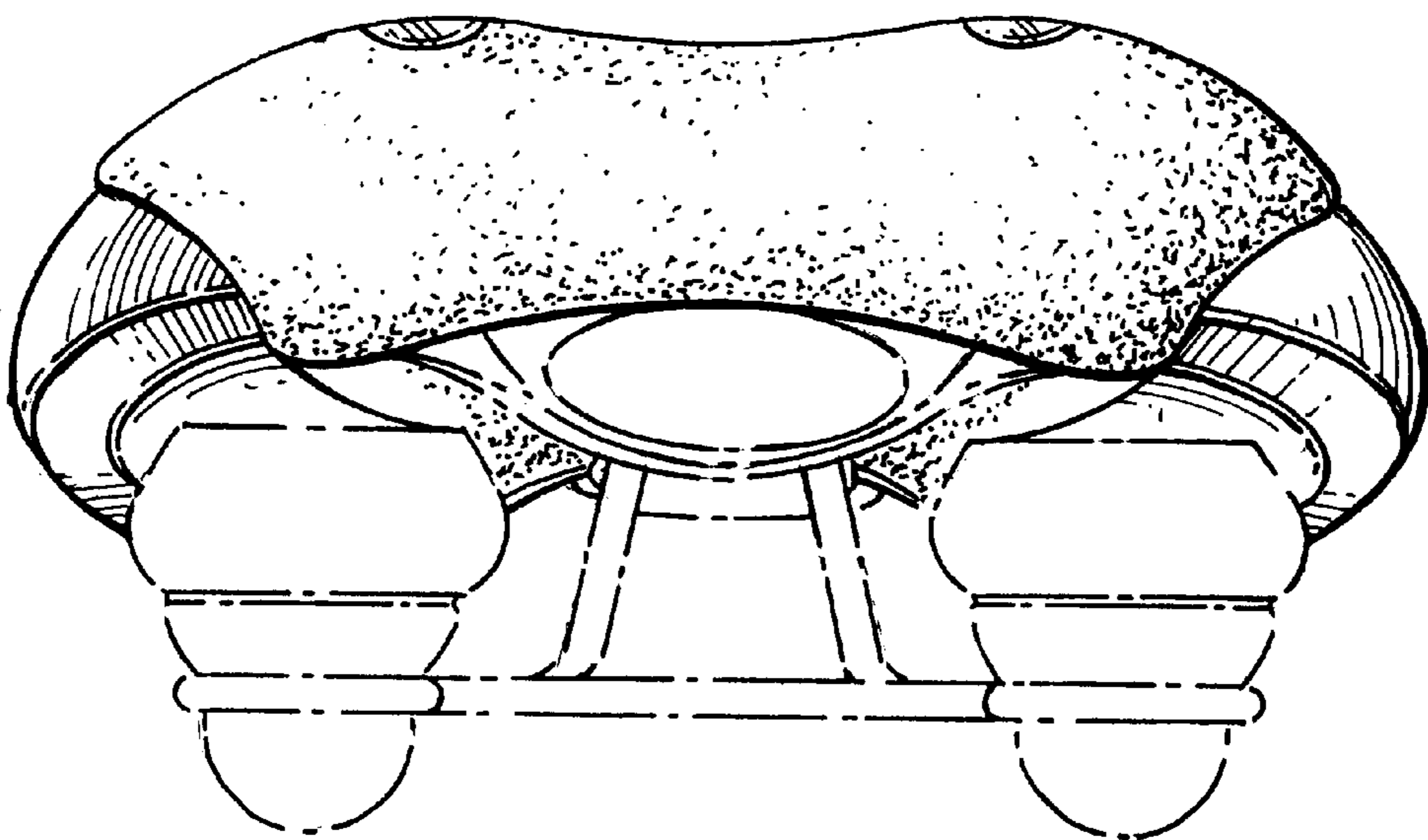

FIG. 4

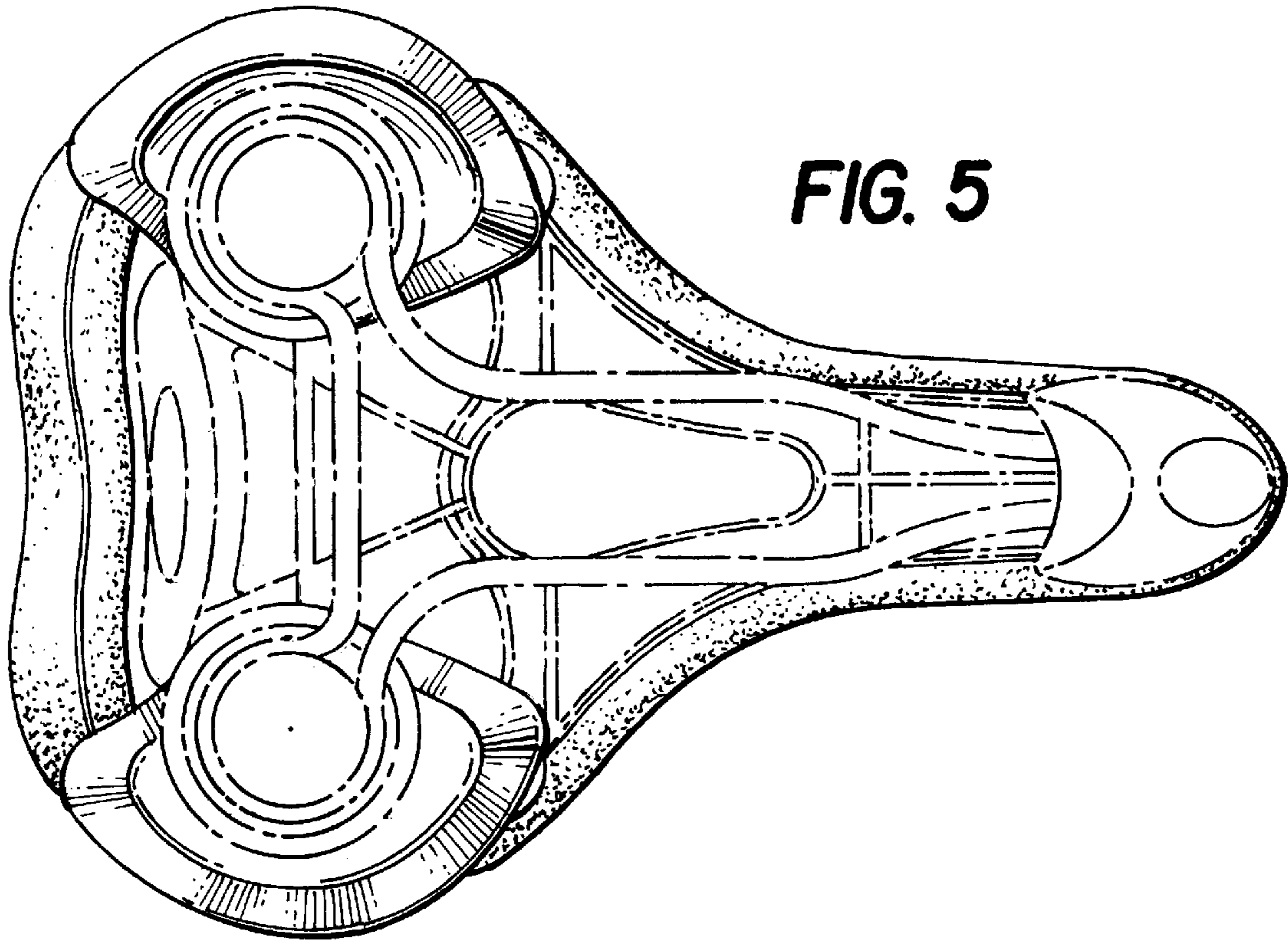
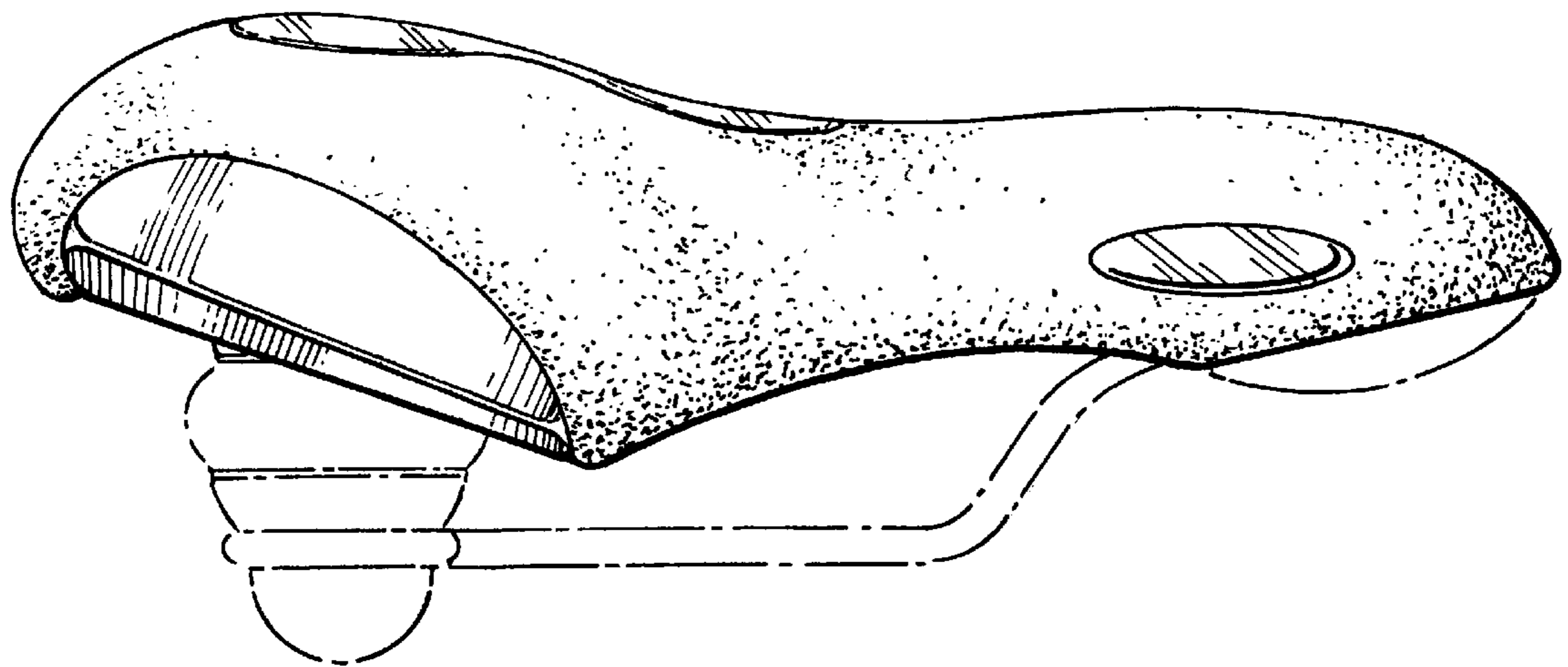

FIG. 6



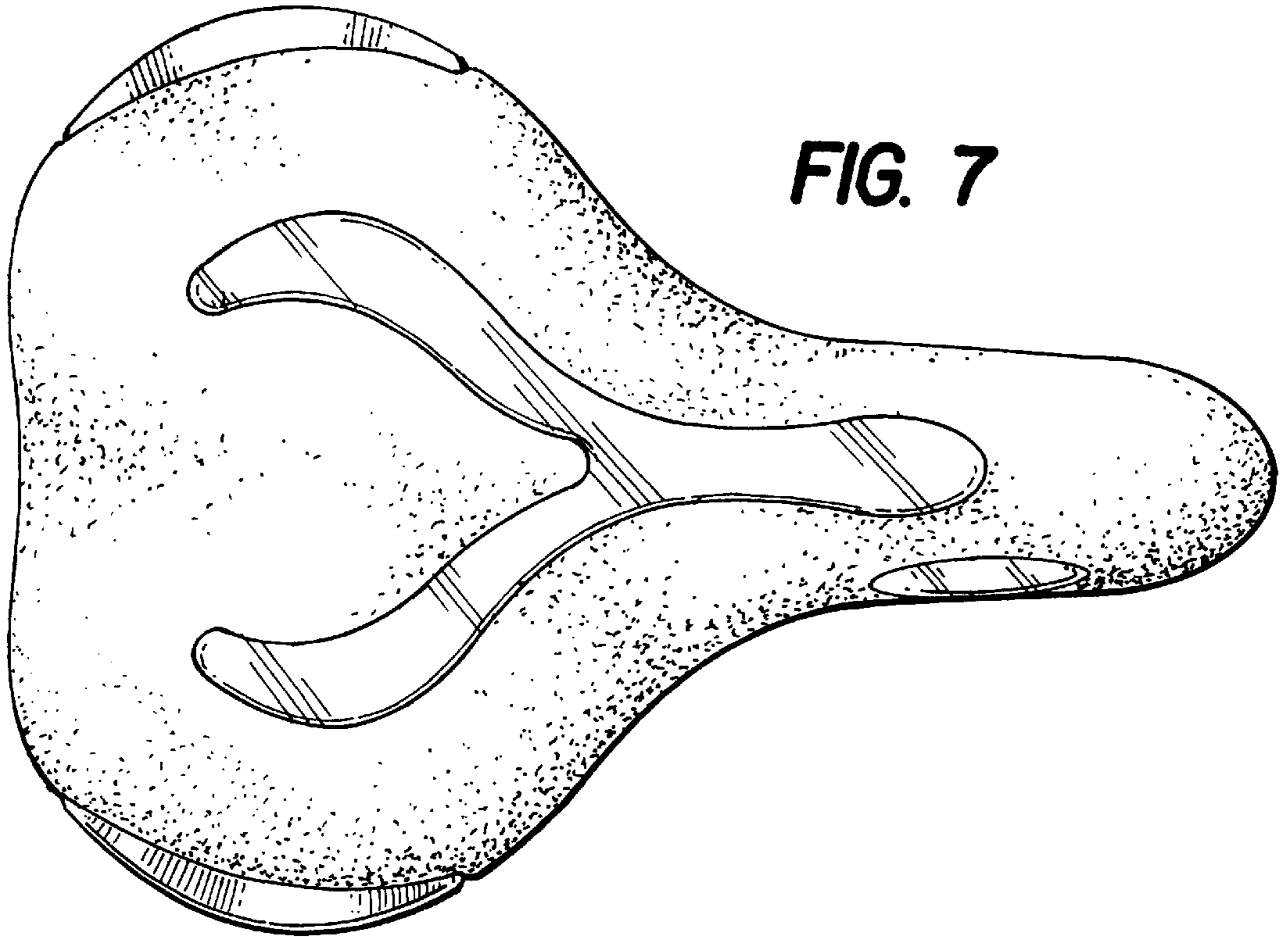

FIG. 7

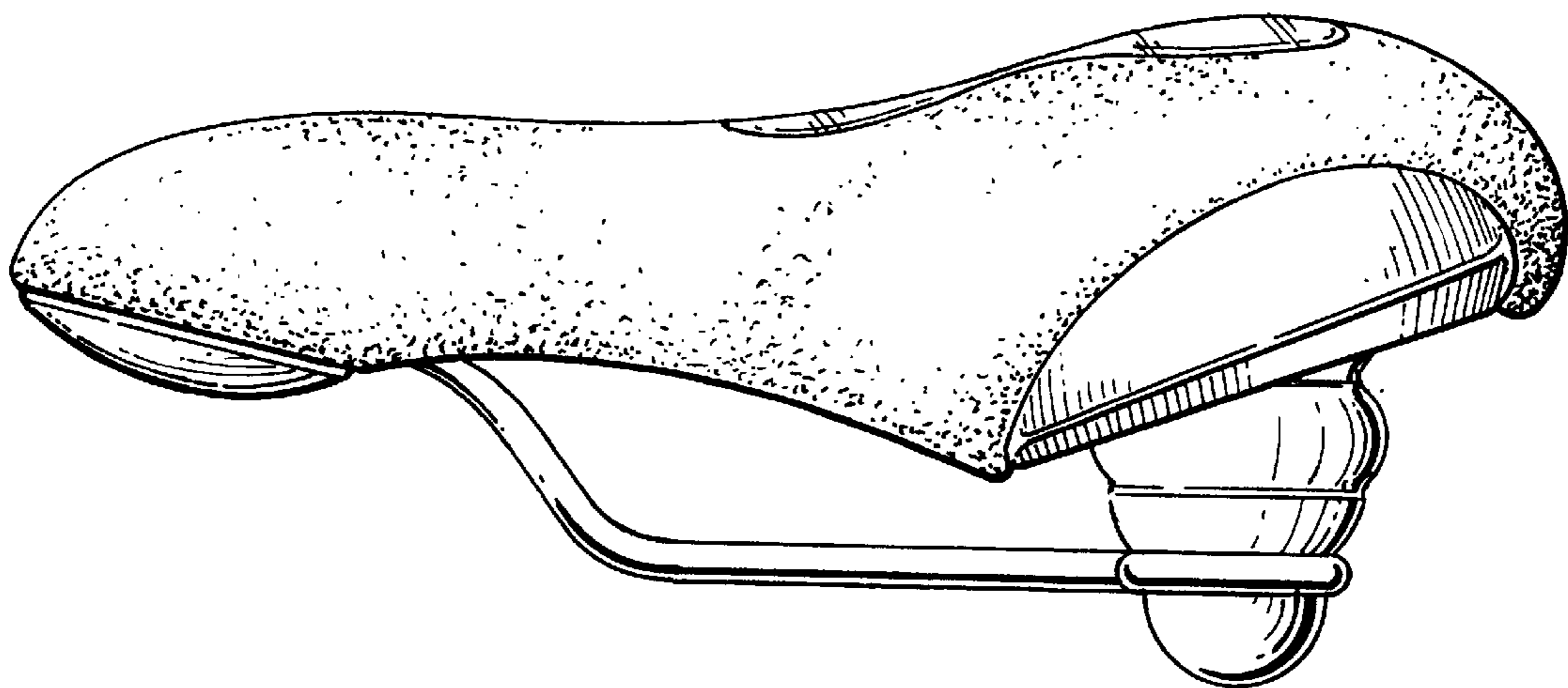

FIG. 8

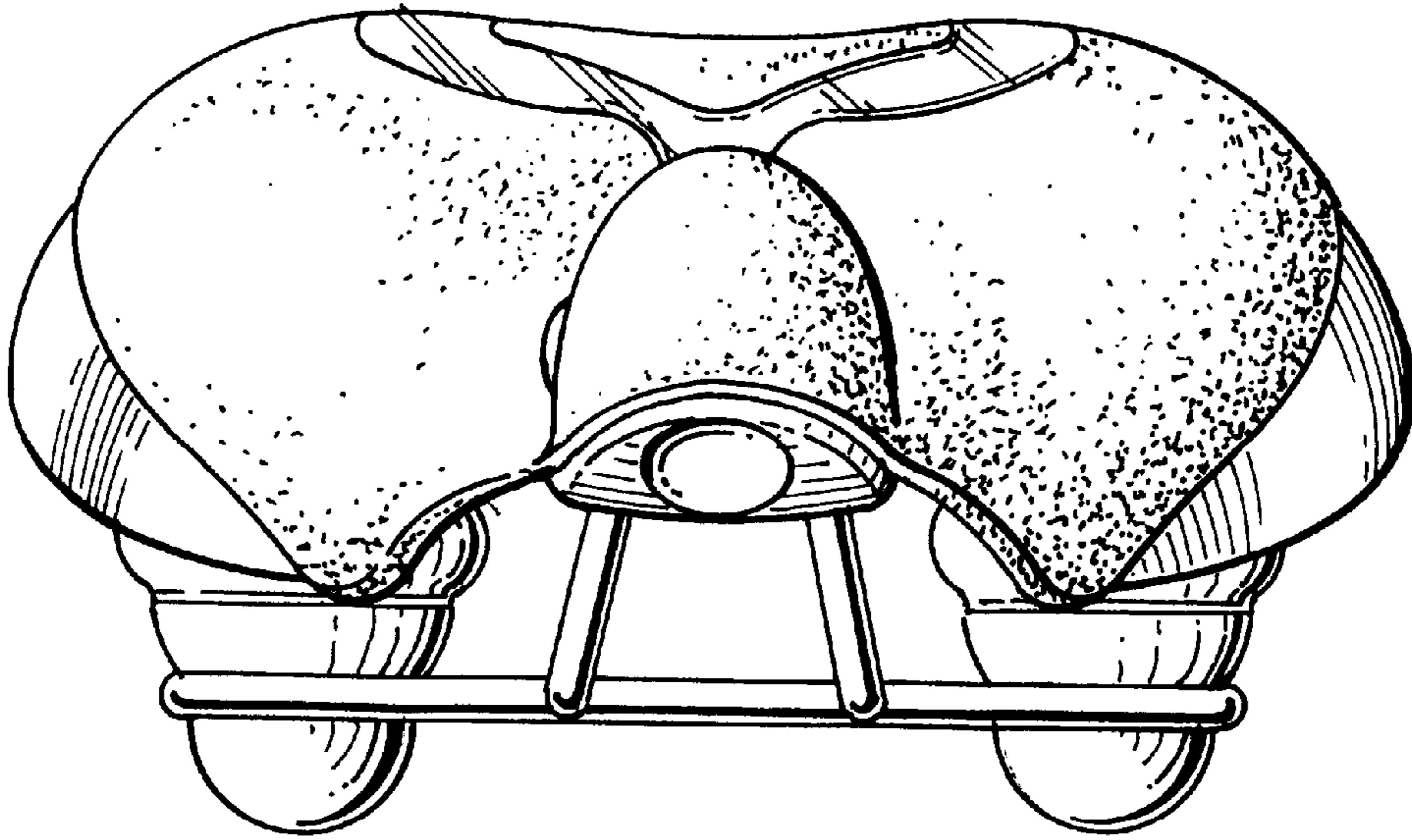

FIG. 9

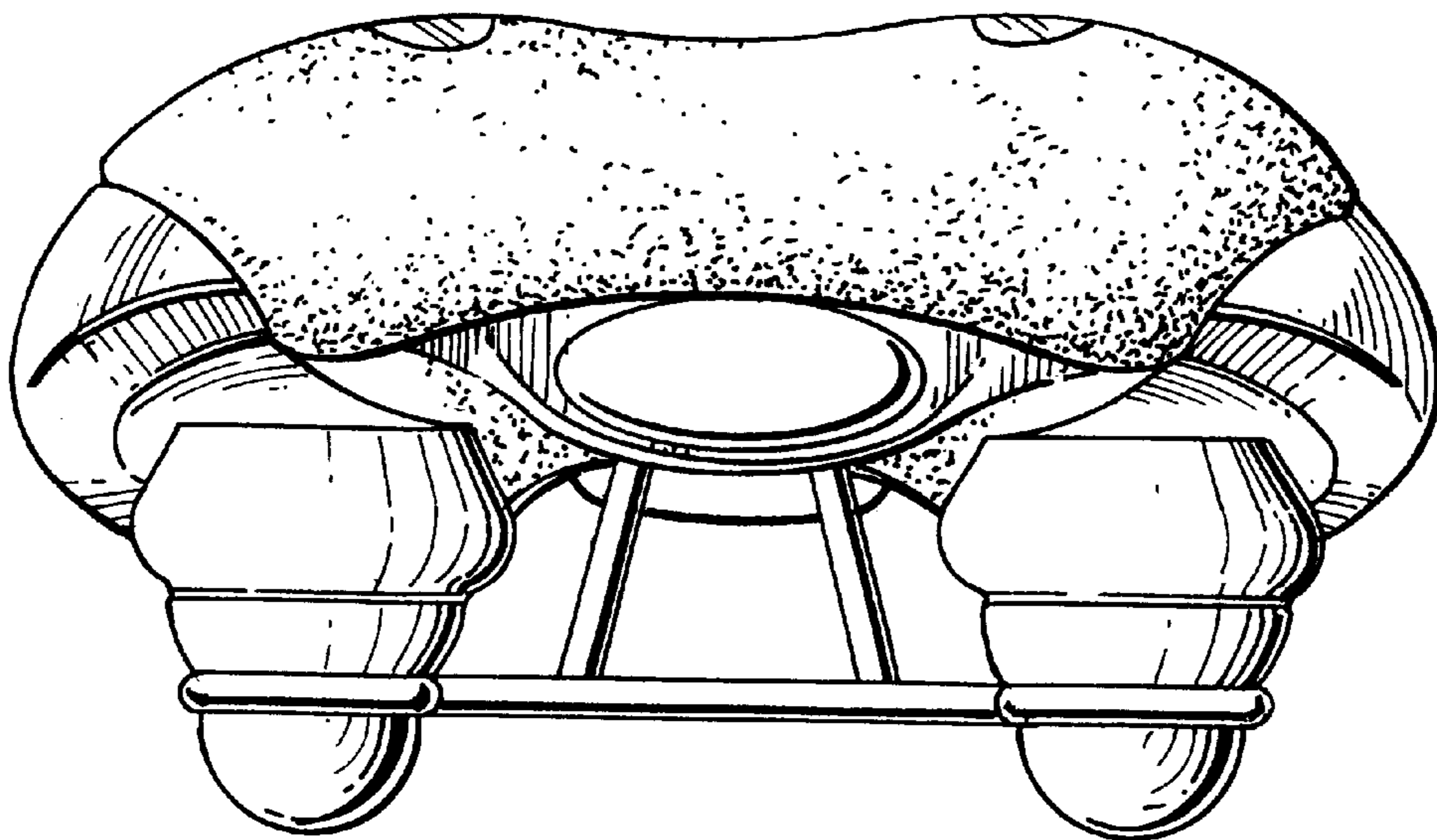

FIG. 10

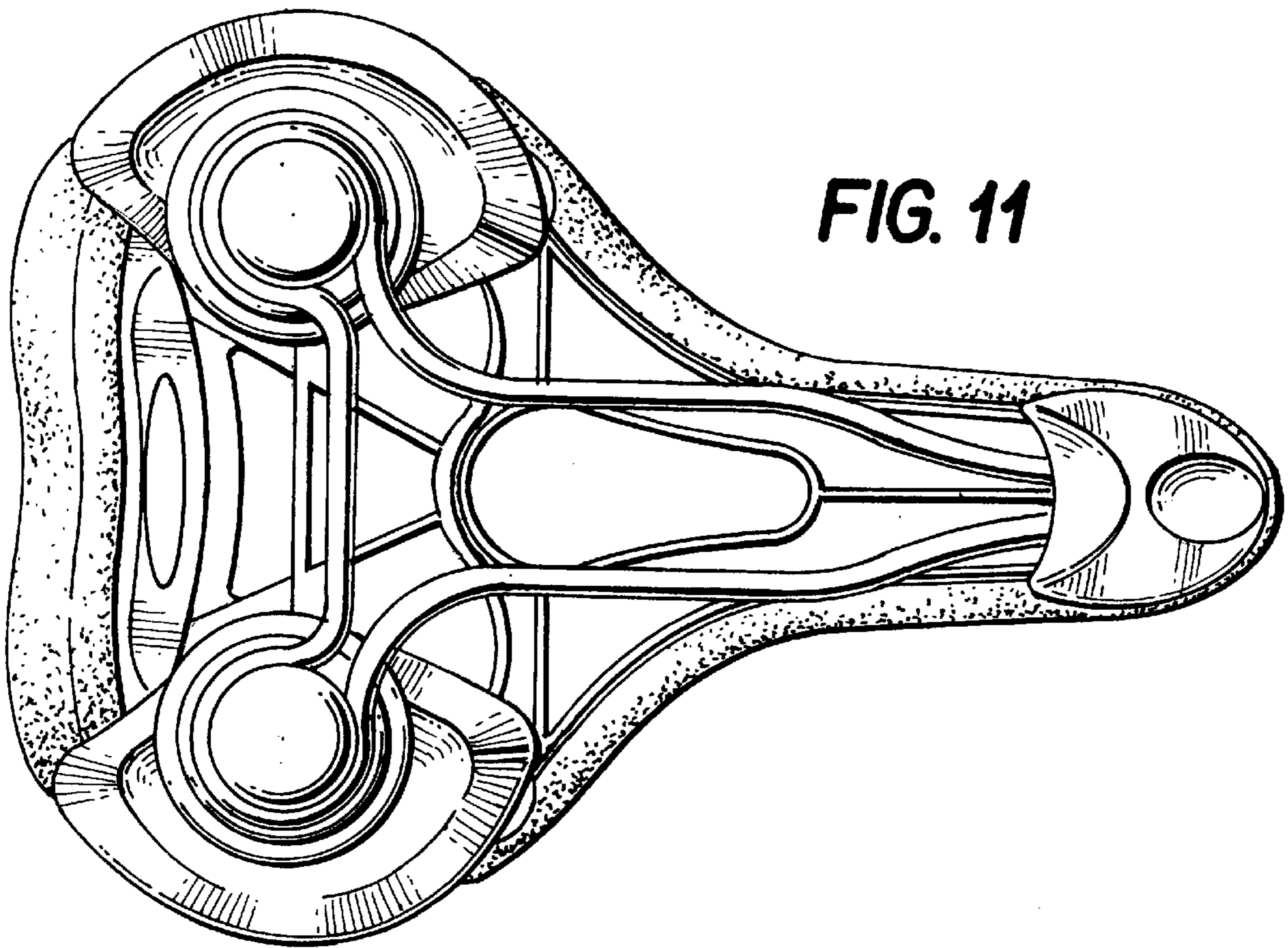
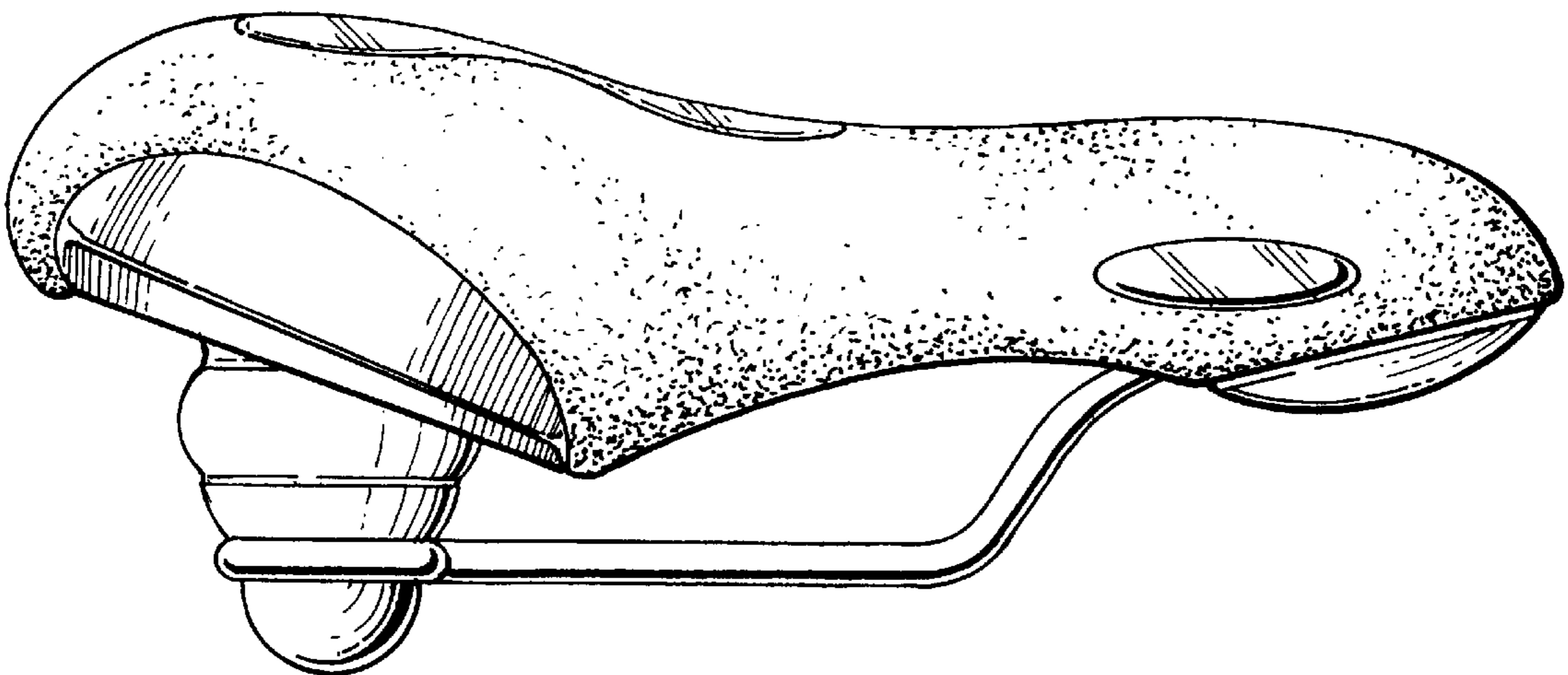

FIG. 12



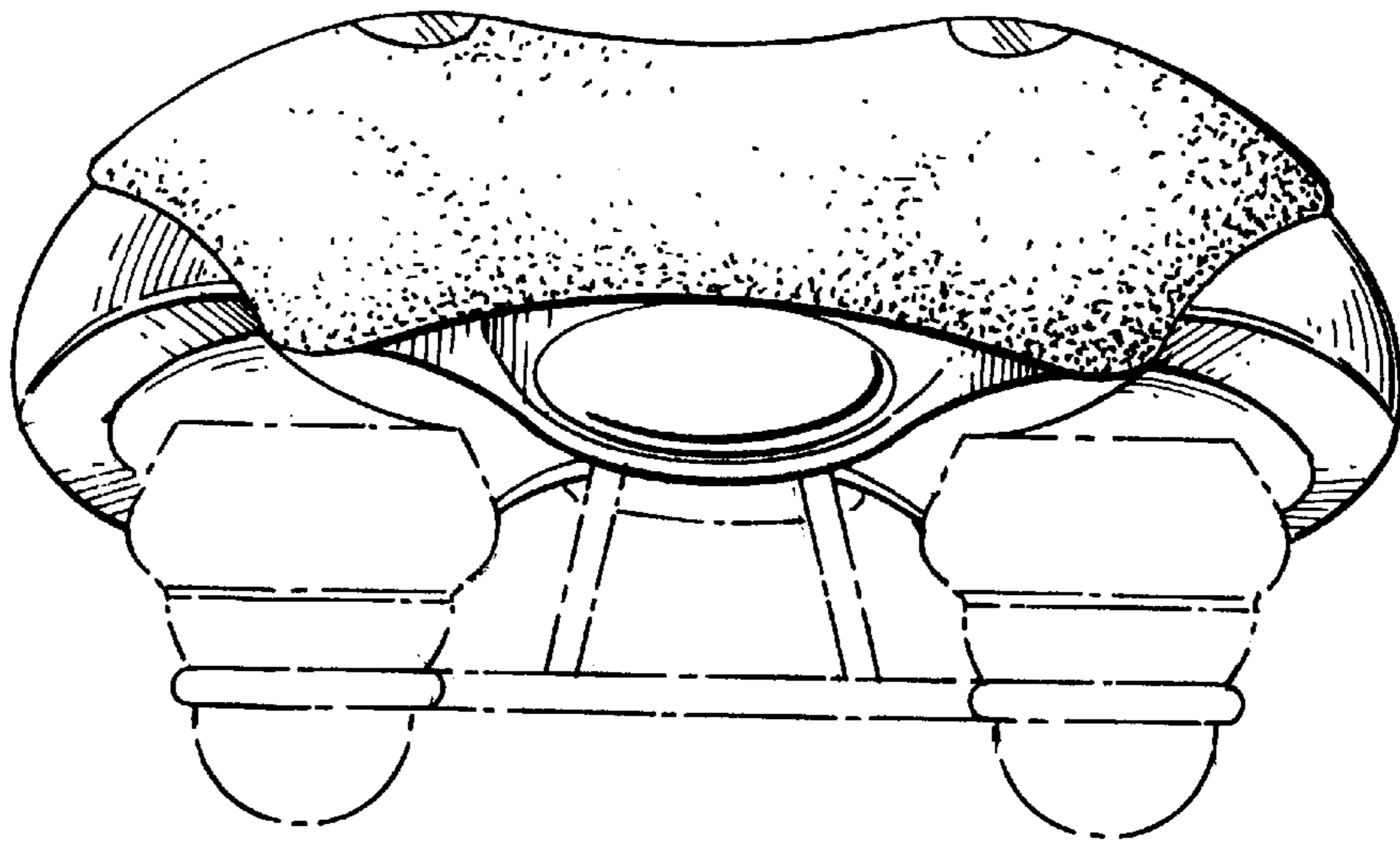

FIG. 13

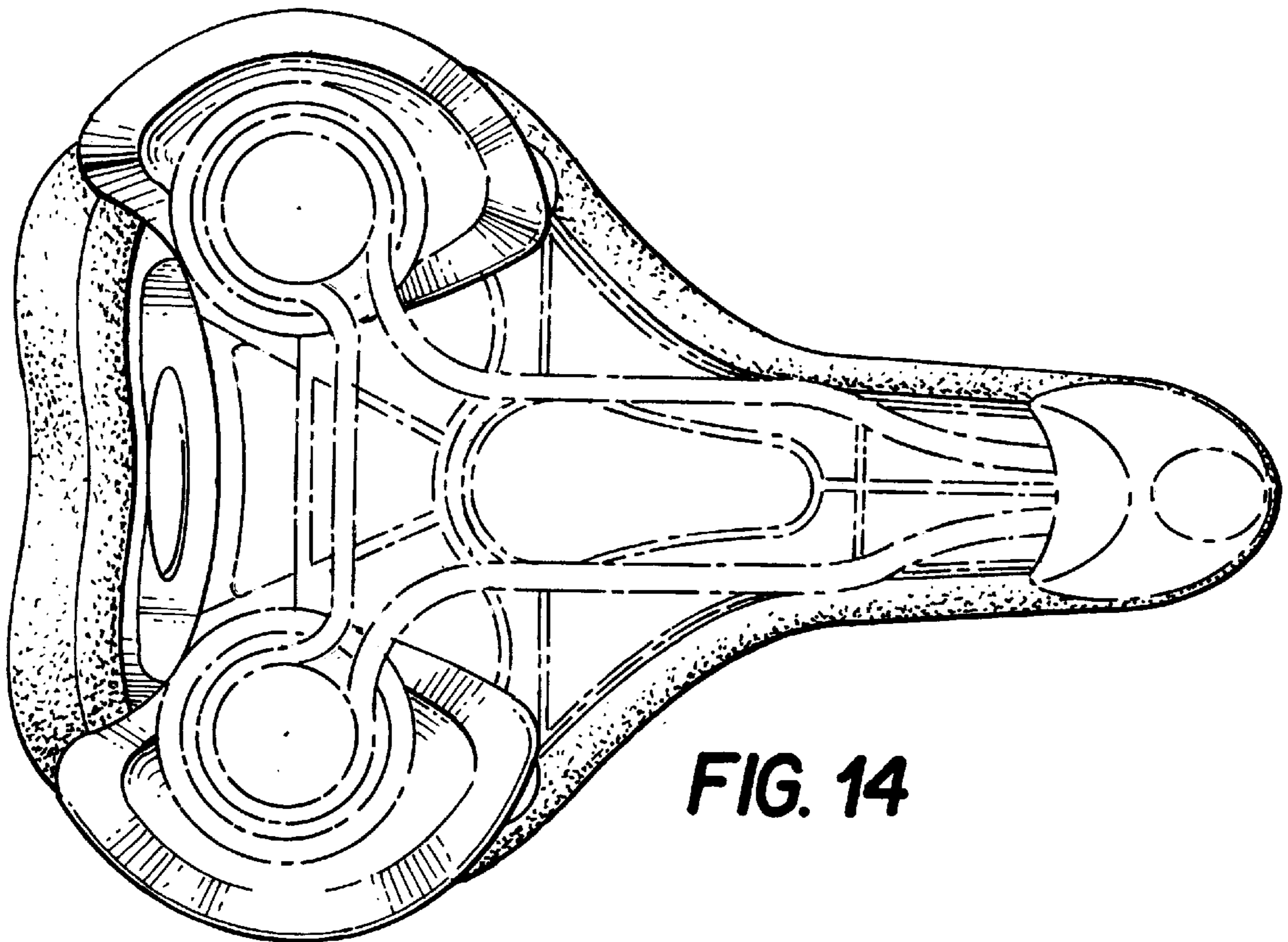

FIG. 14