



US00D439491S

(12) **United States Design Patent**
Falt

(10) **Patent No.:** **US D439,491 S**

(45) **Date of Patent:** **** Mar. 27, 2001**

(54) **UTILITY KNIFE**

(75) Inventor: **Peter F. Falt**, Overland Park, KS (US)

(73) Assignee: **Hunt Holdings, Inc.**, Wilmington, DE (US)

(**) Term: **14 Years**

(21) Appl. No.: **29/106,640**

(22) Filed: **Jun. 18, 1999**

Related U.S. Application Data

(63) Continuation-in-part of application No. 29/096,045, filed on Nov. 4, 1998, now abandoned.

(51) **LOC (7) Cl.** **08-03**

(52) **U.S. Cl.** **D8/98; D8/99**

(58) **Field of Search** D8/98, 99, 100, D8/107; 30/162, 320, 329, 335, 125

(56) **References Cited**

U.S. PATENT DOCUMENTS

D. 234,570 * 3/1975 Craddock D8/98

(List continued on next page.)

Primary Examiner—Philip S. Hyder

(74) *Attorney, Agent, or Firm*—Synnestvedt & Lechner LLP

(57) **CLAIM**

I claim the ornamental design for a utility knife, as shown and described.

DESCRIPTION

FIG. 1 is a right side elevational view of a utility knife, showing my new design.

FIG. 2 is a left side view of the knife of FIG. 1;

FIG. 3 is a top view of the knife of FIG. 1;

FIG. 4 is a bottom view of the knife of FIG. 1;

FIG. 5 is a front end view of the knife of FIG. 1;

FIG. 6 is a rear end view of the knife of FIG. 1;

FIG. 7 is a front perspective view of FIG. 1 showing the left side of the knife;

FIG. 8 is a perspective view of FIG. 1 showing the left side view of the knife, the blade being shown in broken line for illustrative purposes only, the blade forming no part of the claimed design;

FIG. 9 is a right side view of a modified embodiment of the design, the broken lines showing a clasp and a recess for the clasp for illustrative purposes only and form no part of the claimed design;

FIG. 10 is a left side view of the knife of FIG. 9, the broken lines showing a clasp lever and a recess for the clasp lever for illustrative purposes only and form no part of the claimed design;

FIG. 11 is a top view of the knife of FIG. 9, the broken lines showing the joint line dividing the two halves of the knife, a button, a track in which the button moves, and a recess for the button for illustrative purposes only and form no part of the claimed design;

FIG. 12 is a bottom view of the knife of FIG. 9, the broken lines showing the clasp, the clasp lever, the recesses therefor and the joint line dividing the two halves of the knife for illustrative purposes only and form no part of the claimed design;

FIG. 13 is a front end view of the knife of FIG. 9, the broken lines showing the button, the joint line dividing the two halves of the knife, the track and the recess for the button for illustrative purposes only and form no part of the claimed invention;

FIG. 14 is a rear end view of the knife of FIG. 9, the broken lines showing the joint line dividing the two halves of the knife for illustrative purposes only, these items shown in broken lines forming no part of the claimed design;

FIG. 15 is a front perspective view of FIG. 9 showing the right side of the knife;

FIG. 16 is a front perspective view of FIG. 9 showing the left side of the knife; FIG. 17 is a right side view of the knife of FIG. 9, further showing the knife blade extended and in broken lines; and,

FIG. 18 is a top view of the knife of FIG. 9.

The broken lines are in no way intended to form part of the claimed design and are for illustrative purposes only.

1 Claim, 7 Drawing Sheets

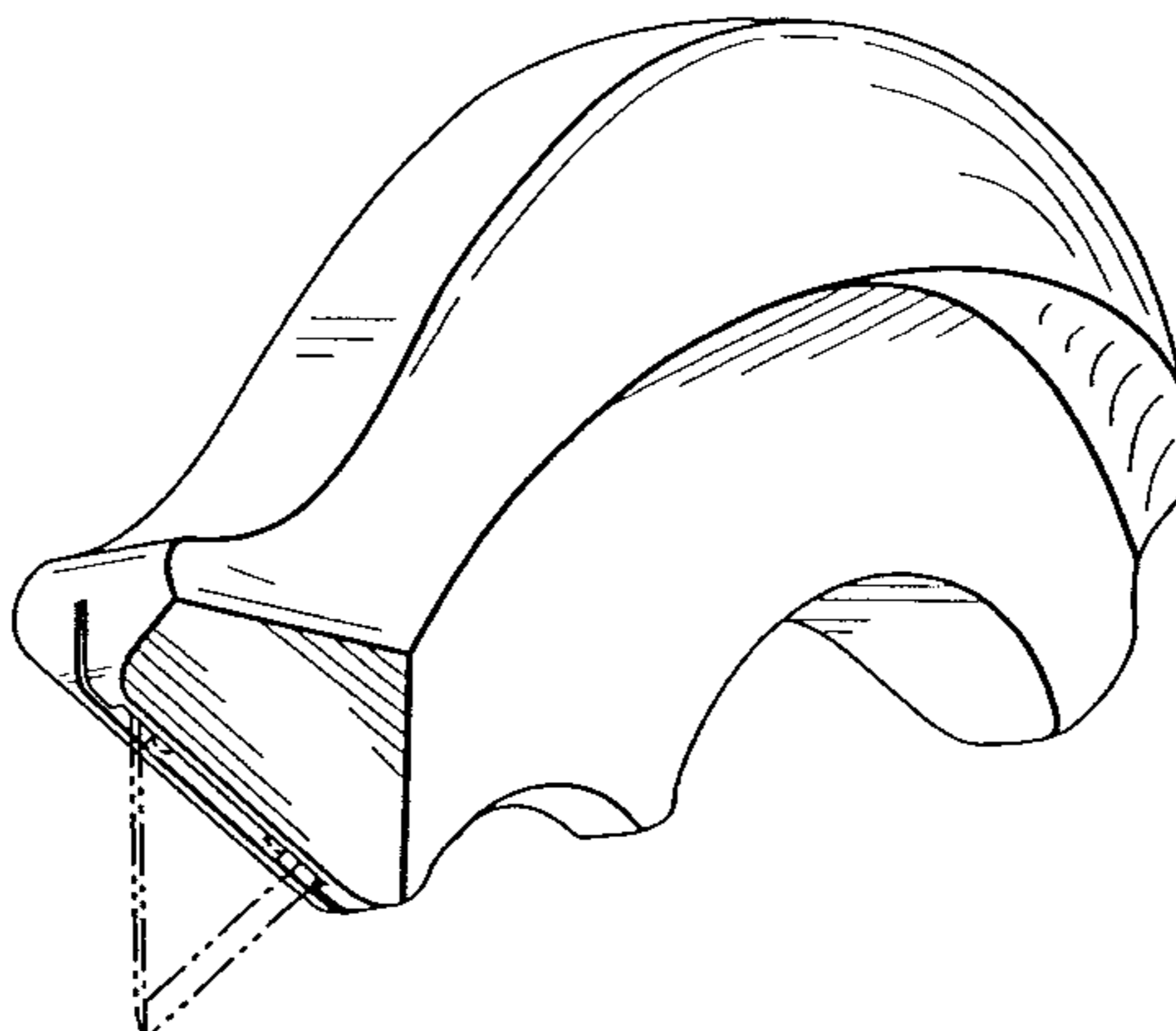

US D439,491 S

Page 2

U.S. PATENT DOCUMENTS

D. 310,475	*	9/1990	Weimann	D8/99	D. 383,963	*	9/1997	Gold	D8/99
D. 311,854	*	11/1990	Wilson et al.	D8/98	D. 399,720	*	10/1998	Owens et al.	D8/98
D. 346,730	*	5/1994	Quiros	D8/99	D. 408,704	*	4/1999	Gilbert	D8/98
D. 349,227	*	8/1994	Ragland et al.	D8/99						

* cited by examiner

FIG. 1

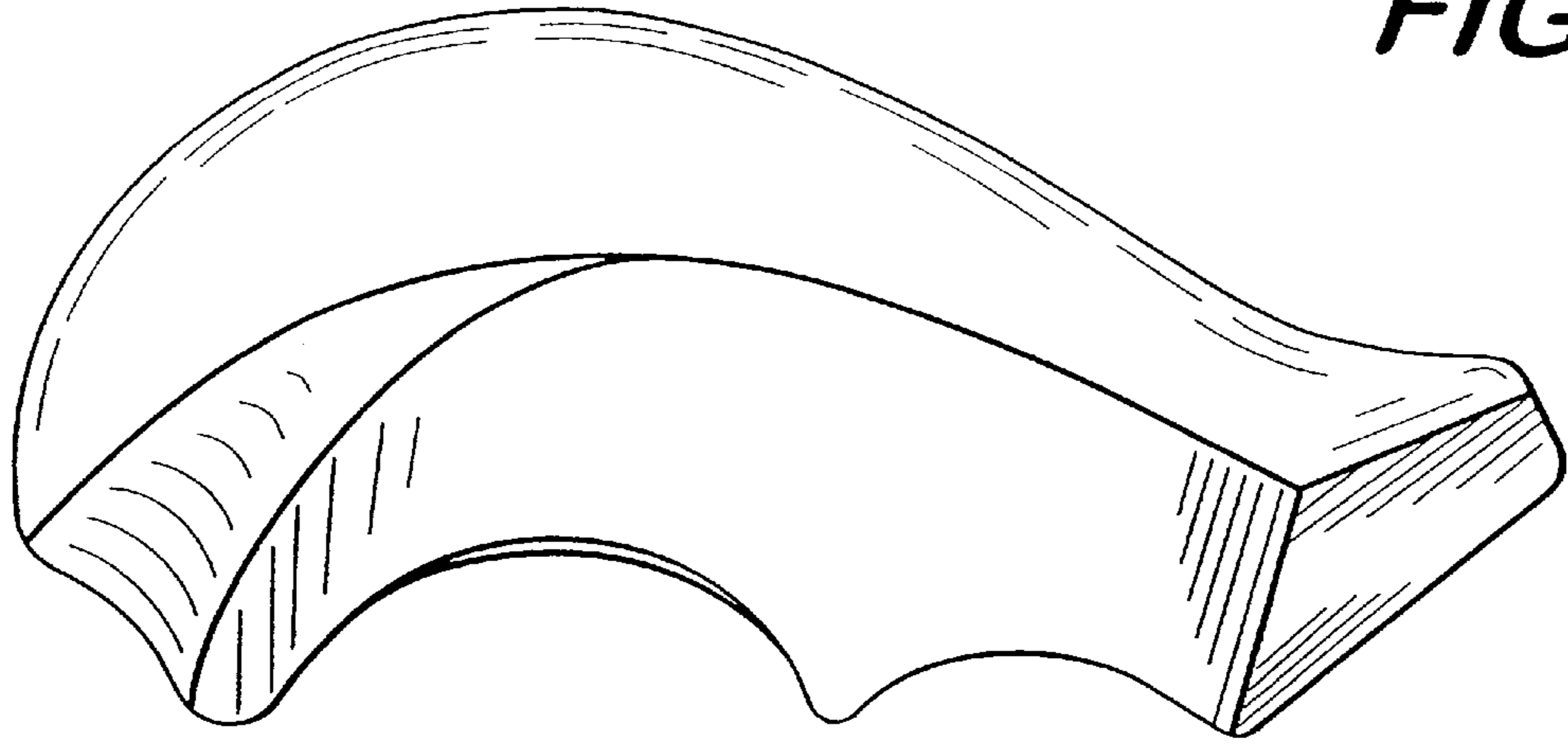

FIG. 2

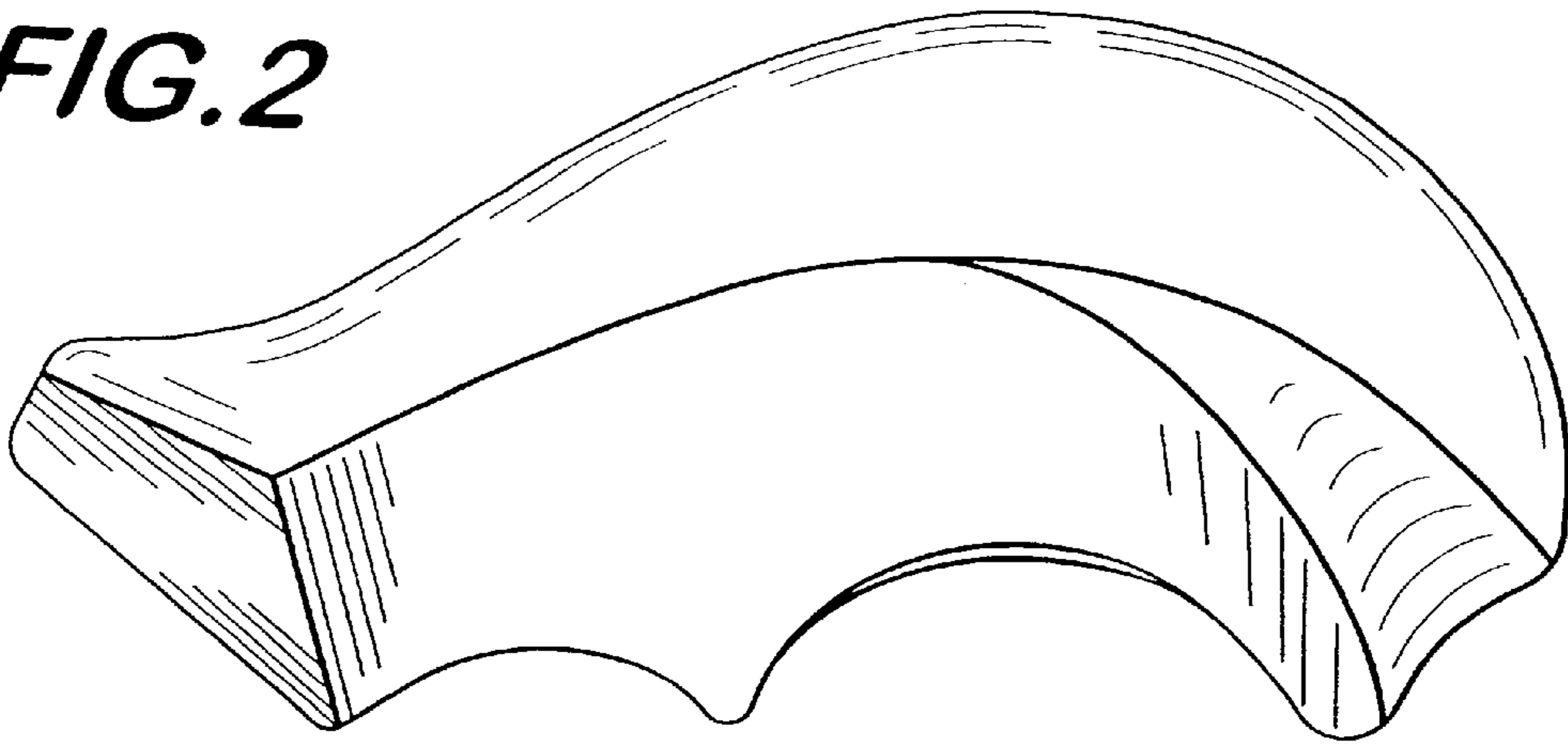

FIG. 3

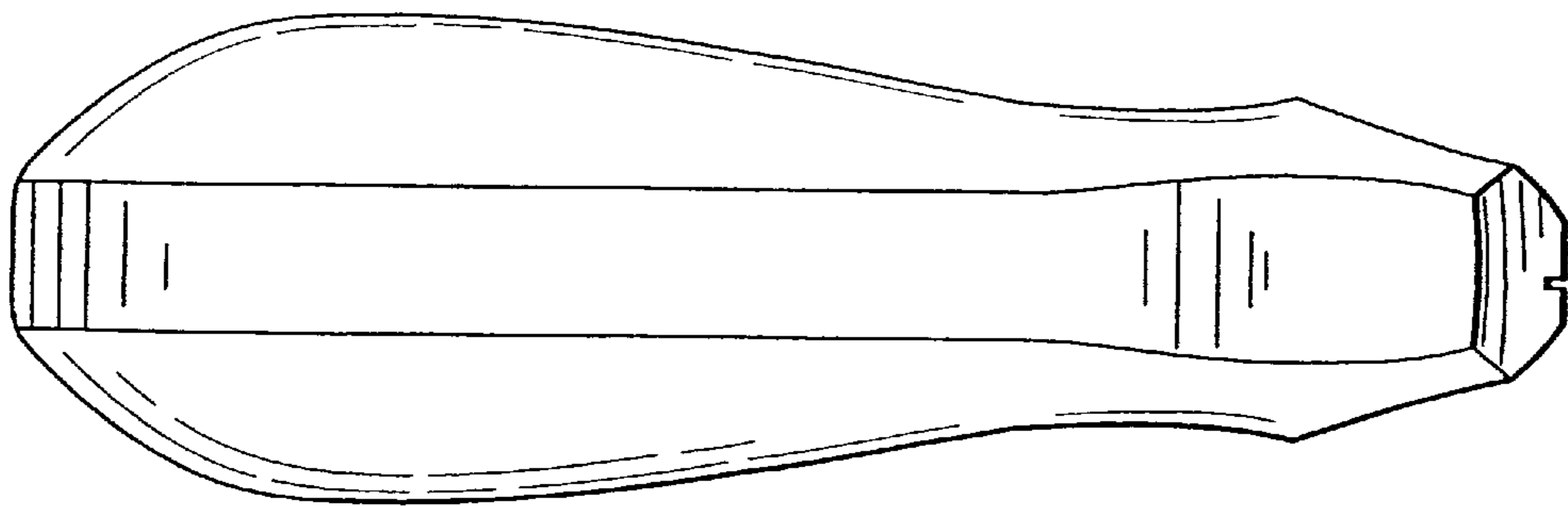

FIG. 4

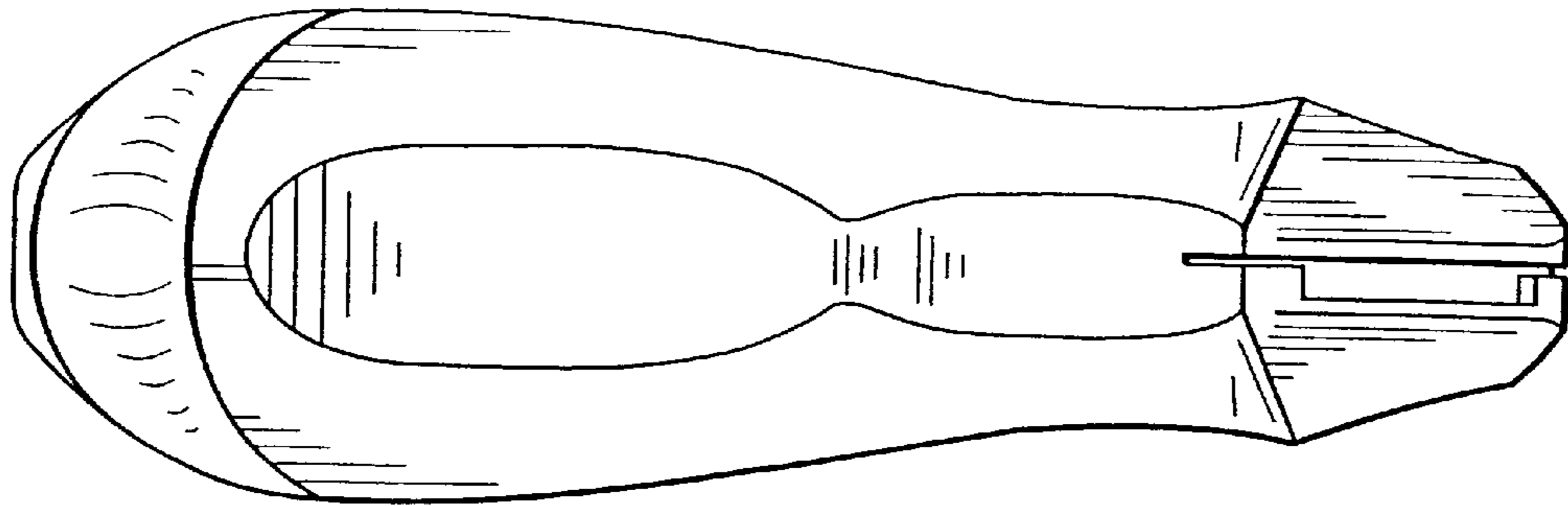

FIG. 5

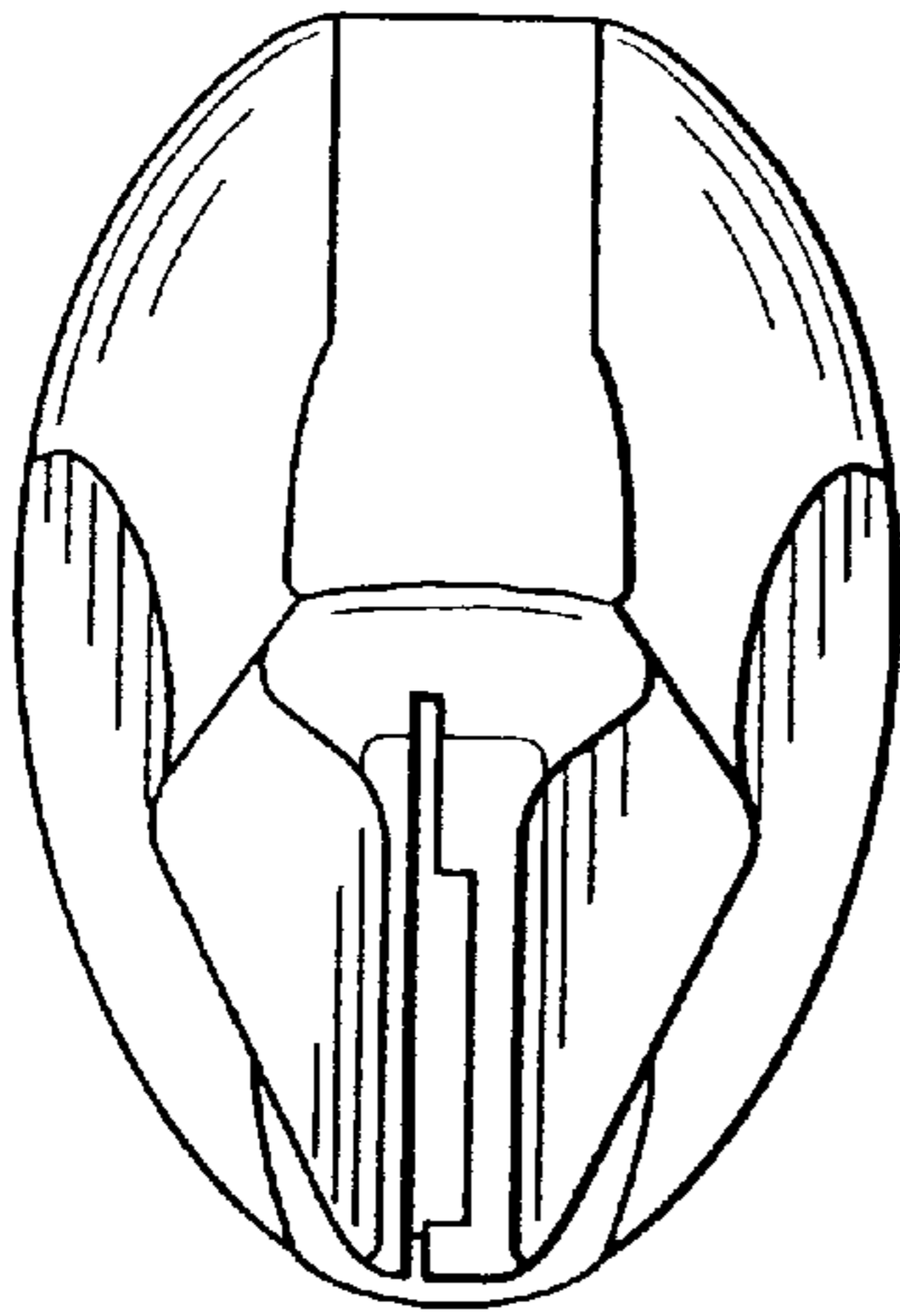

FIG. 6

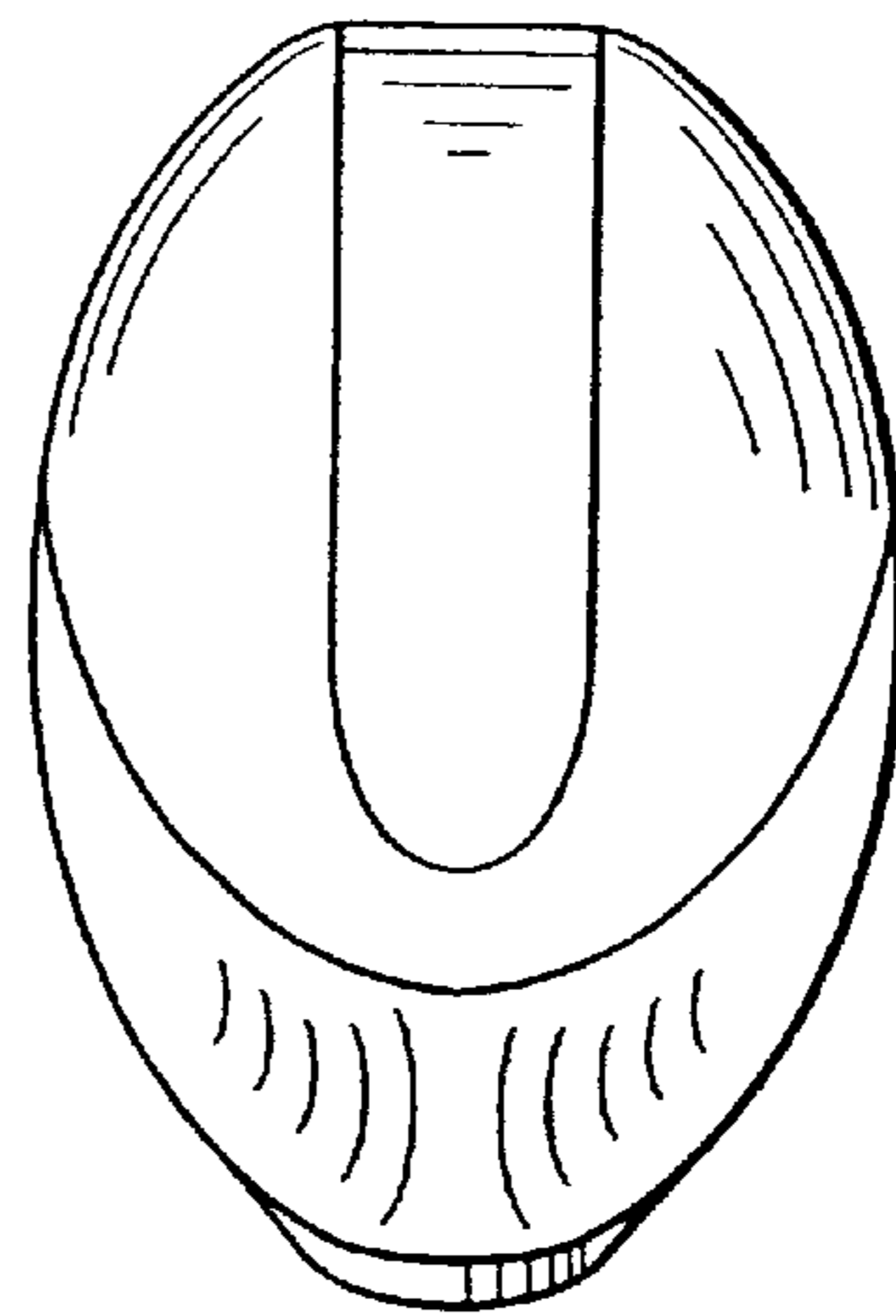

FIG. 7

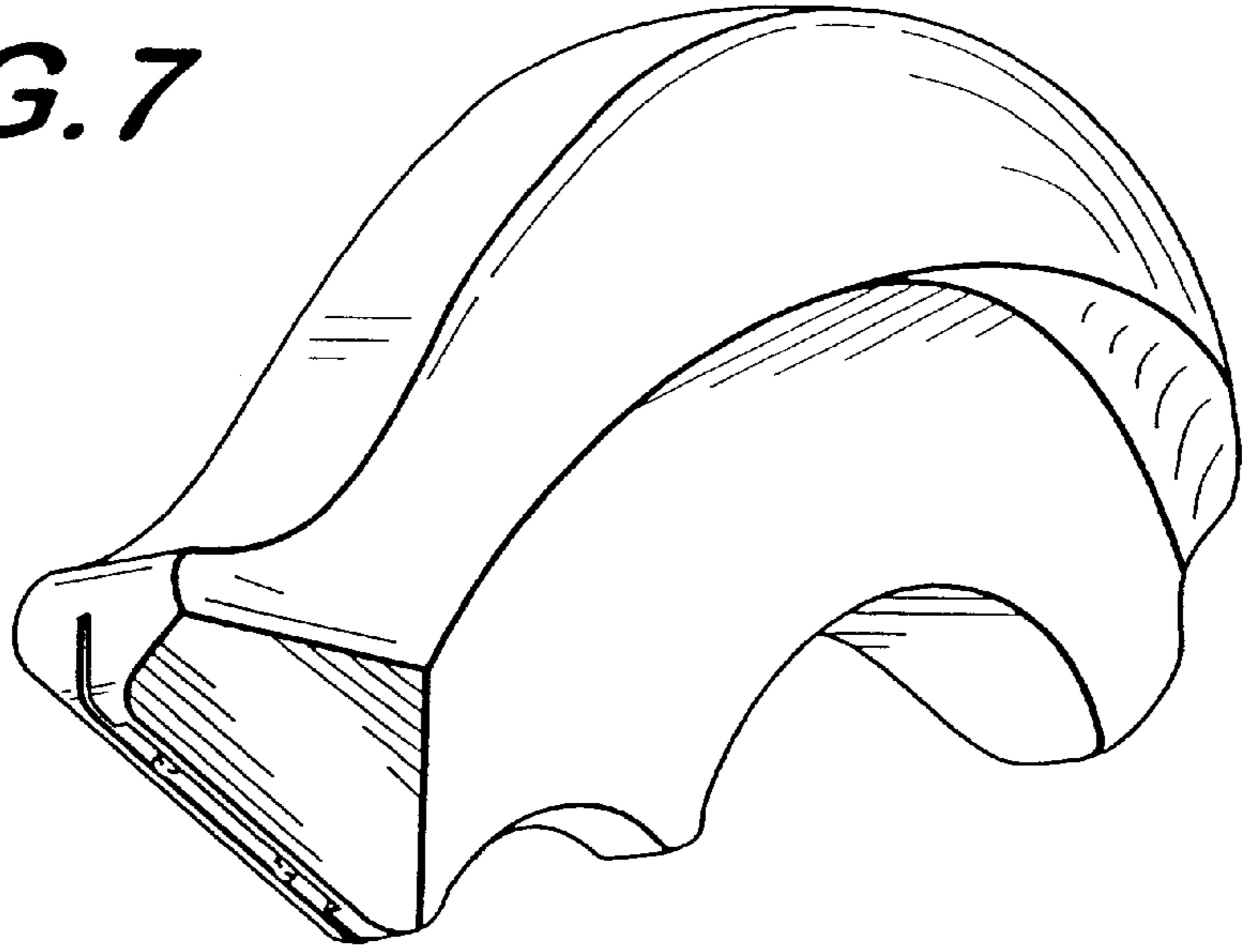

FIG. 8

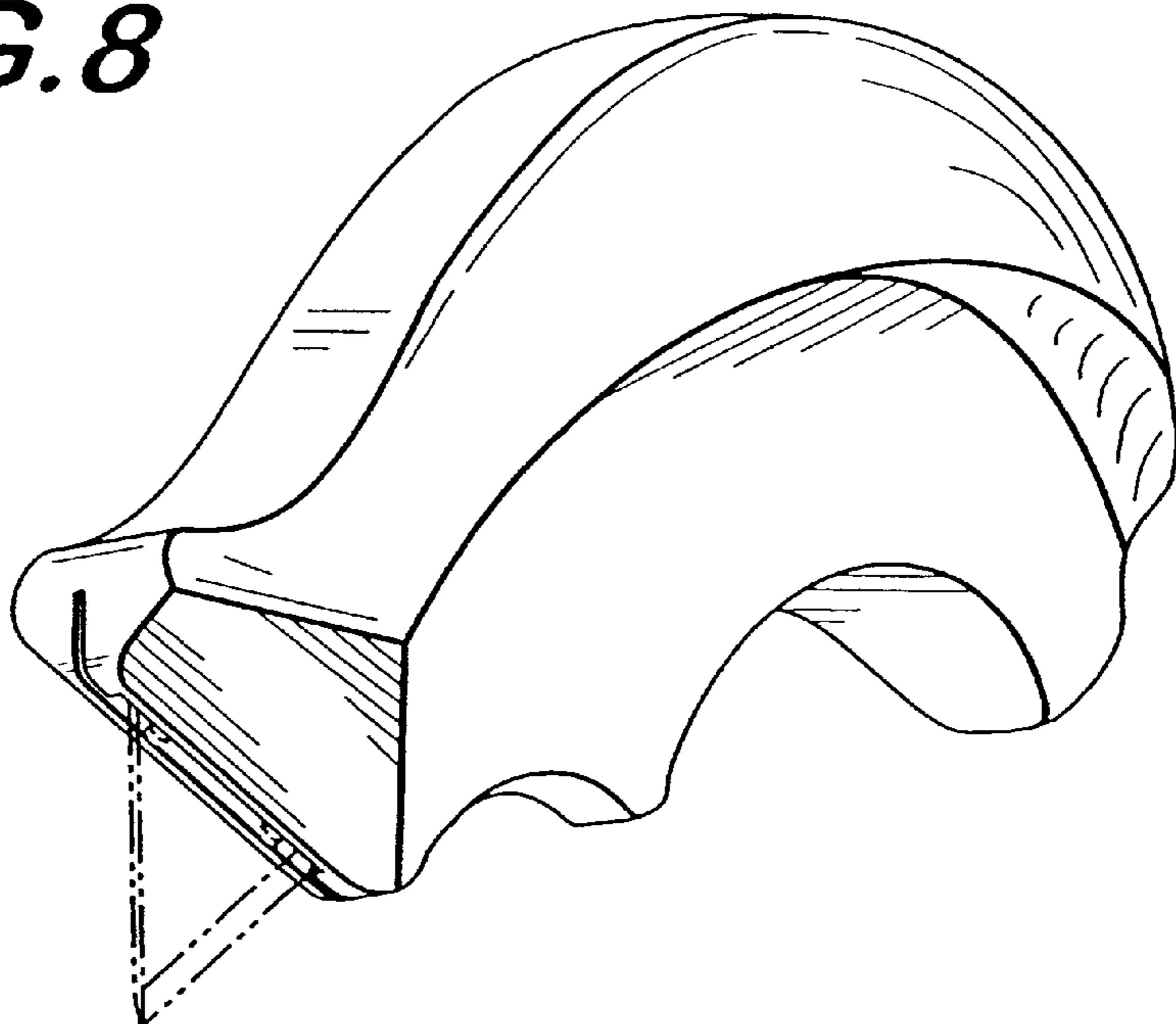

FIG. 9

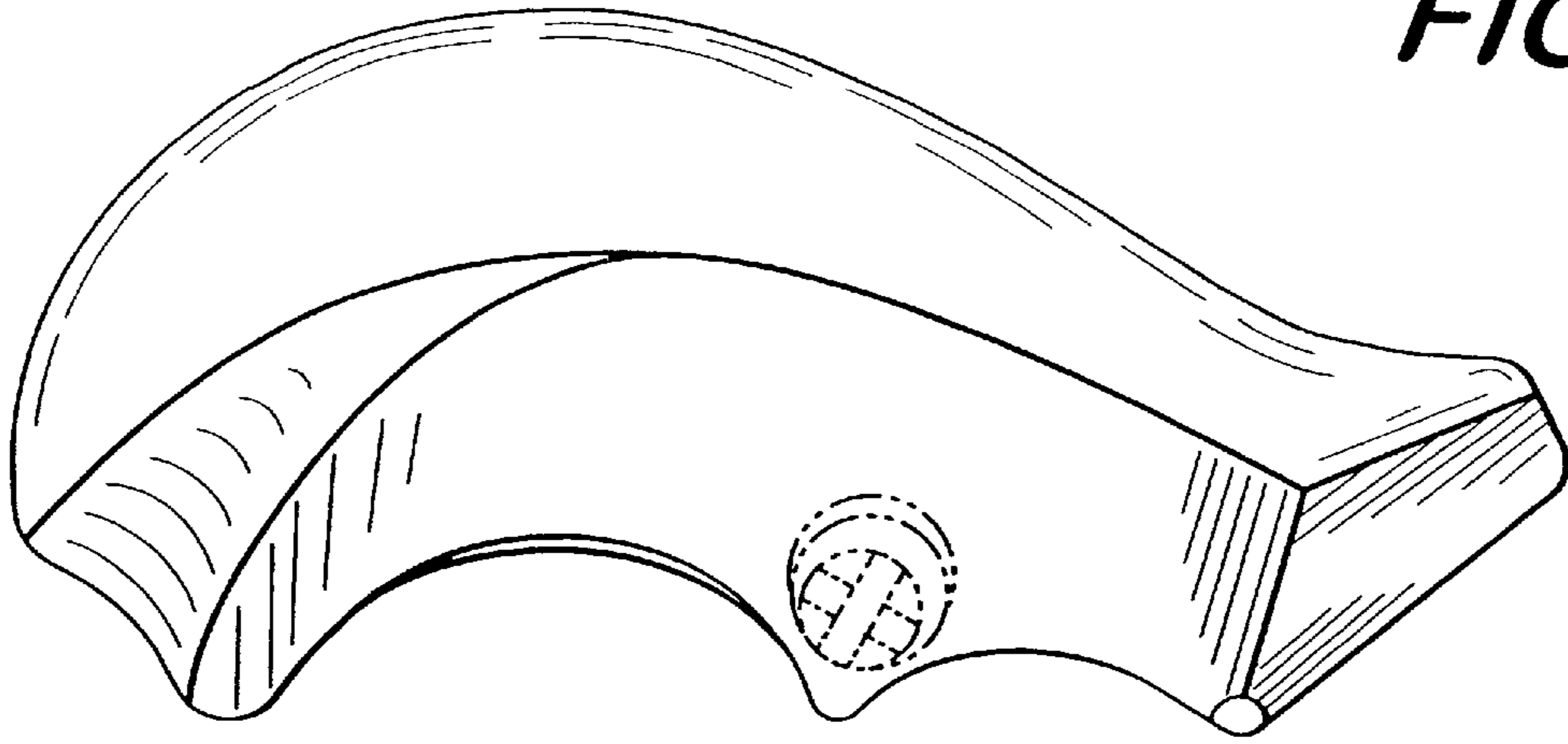

FIG. 10

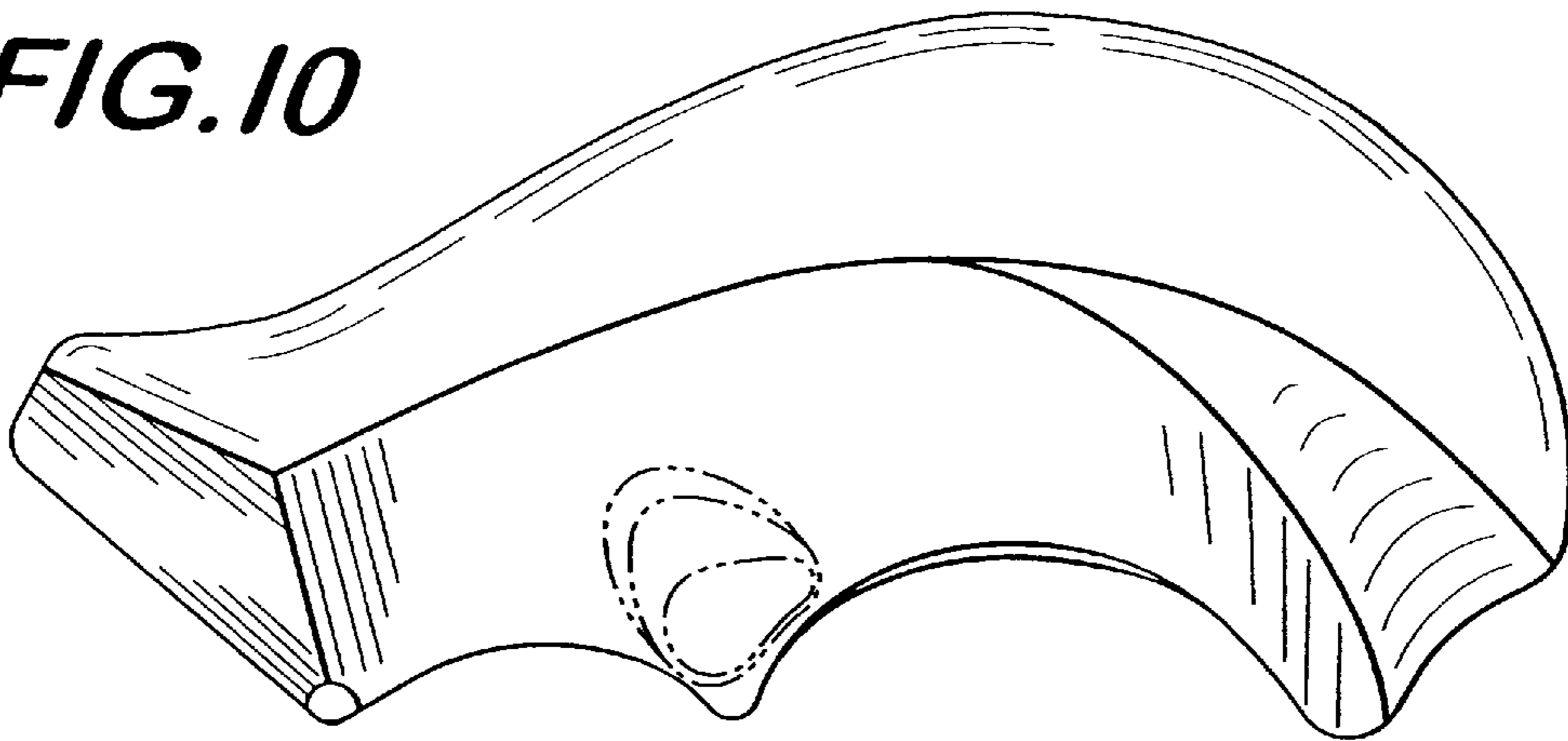

FIG. 11

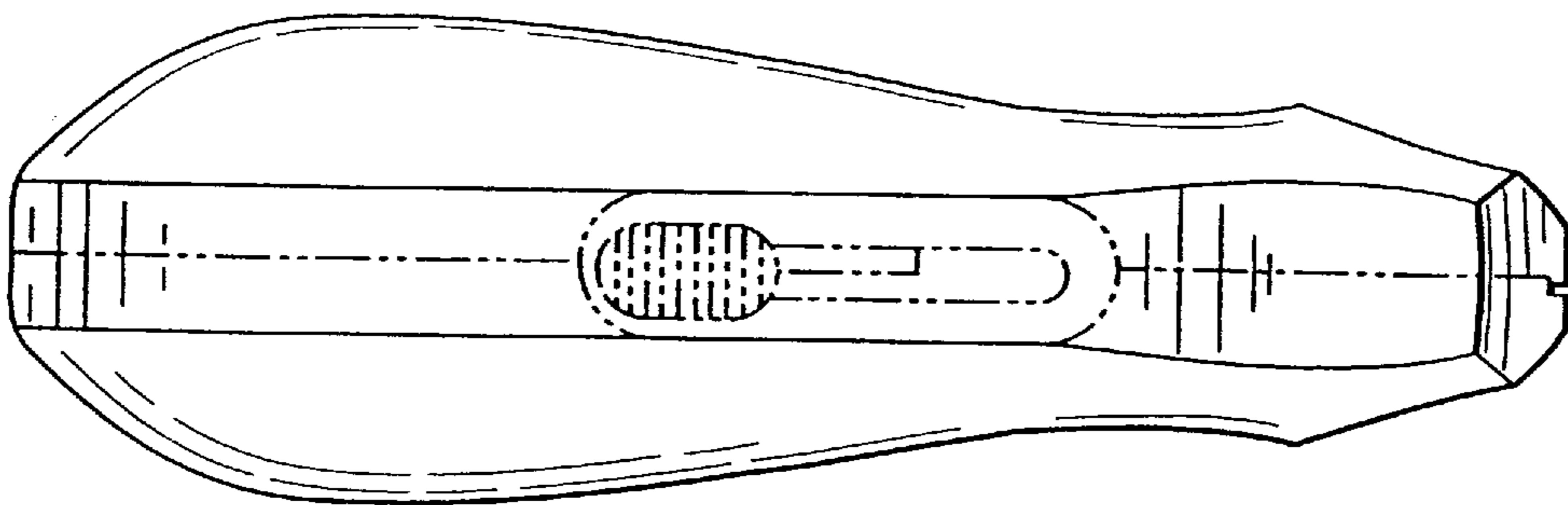

FIG.12

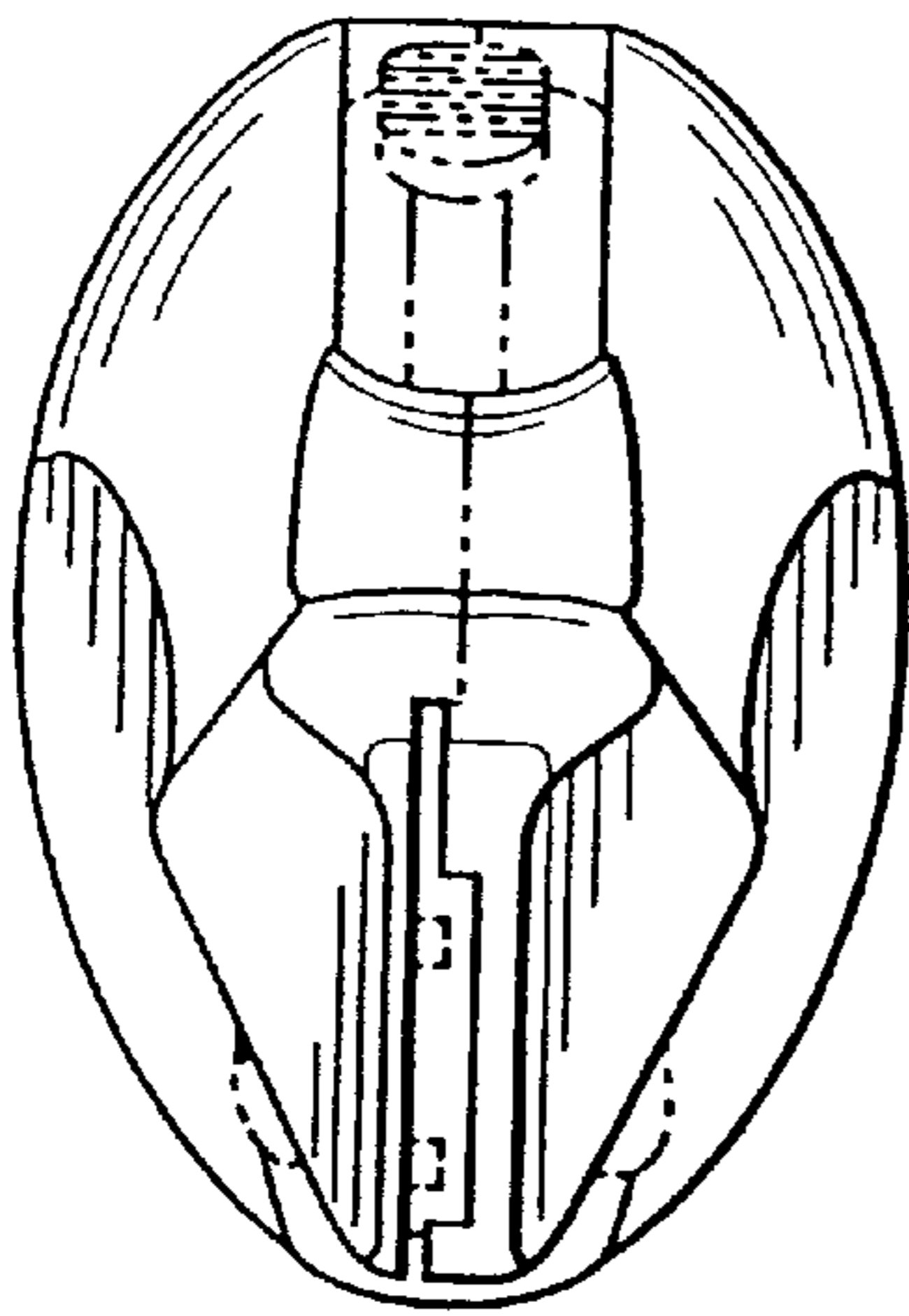
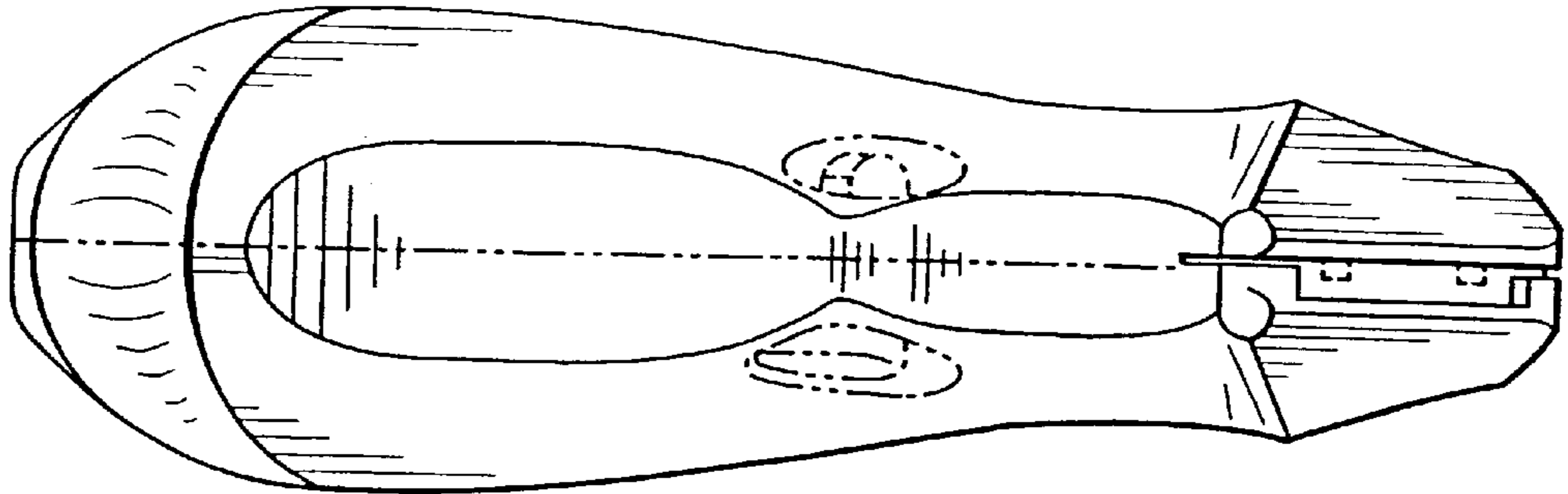

FIG.13

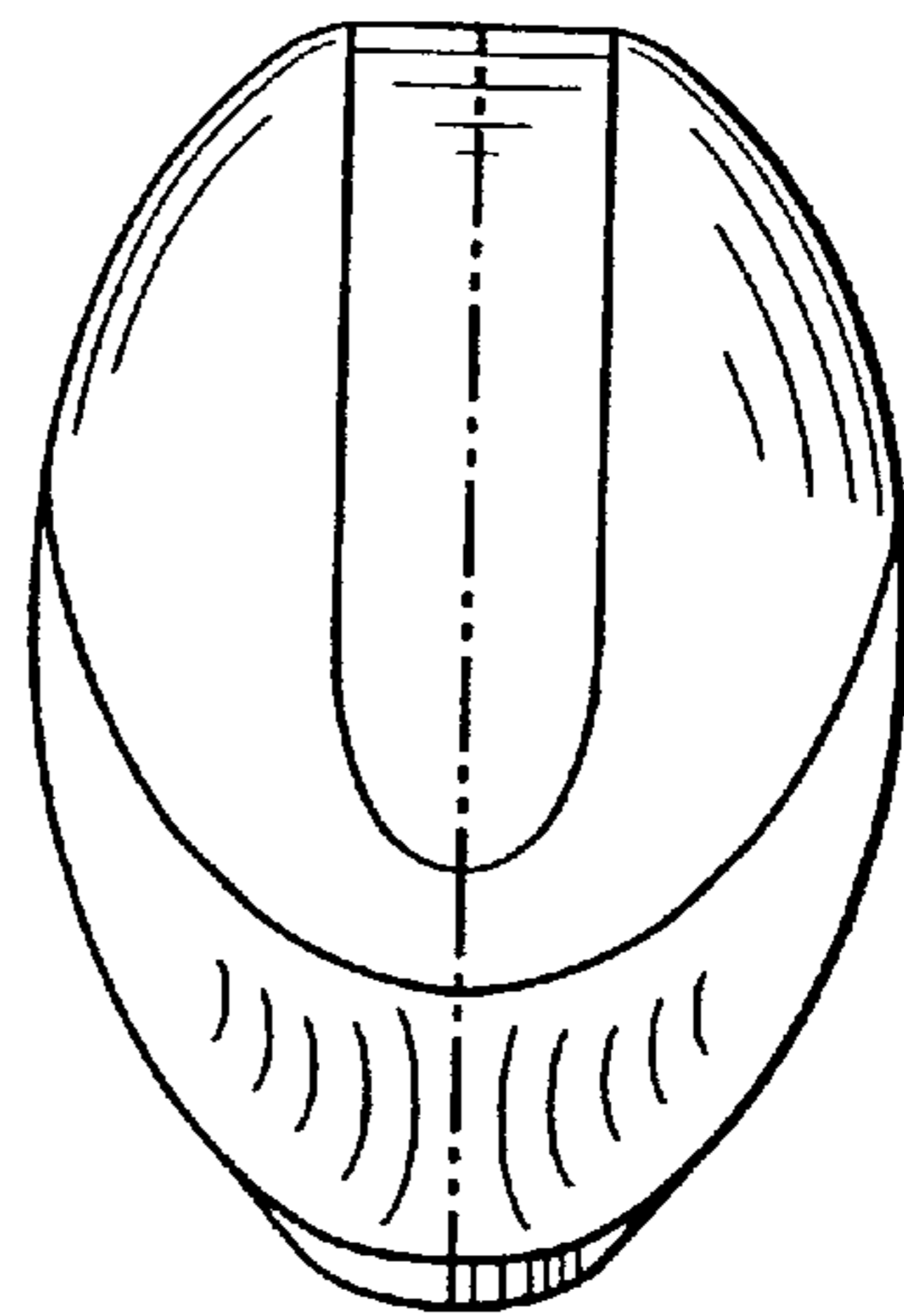

FIG.14

FIG. 15

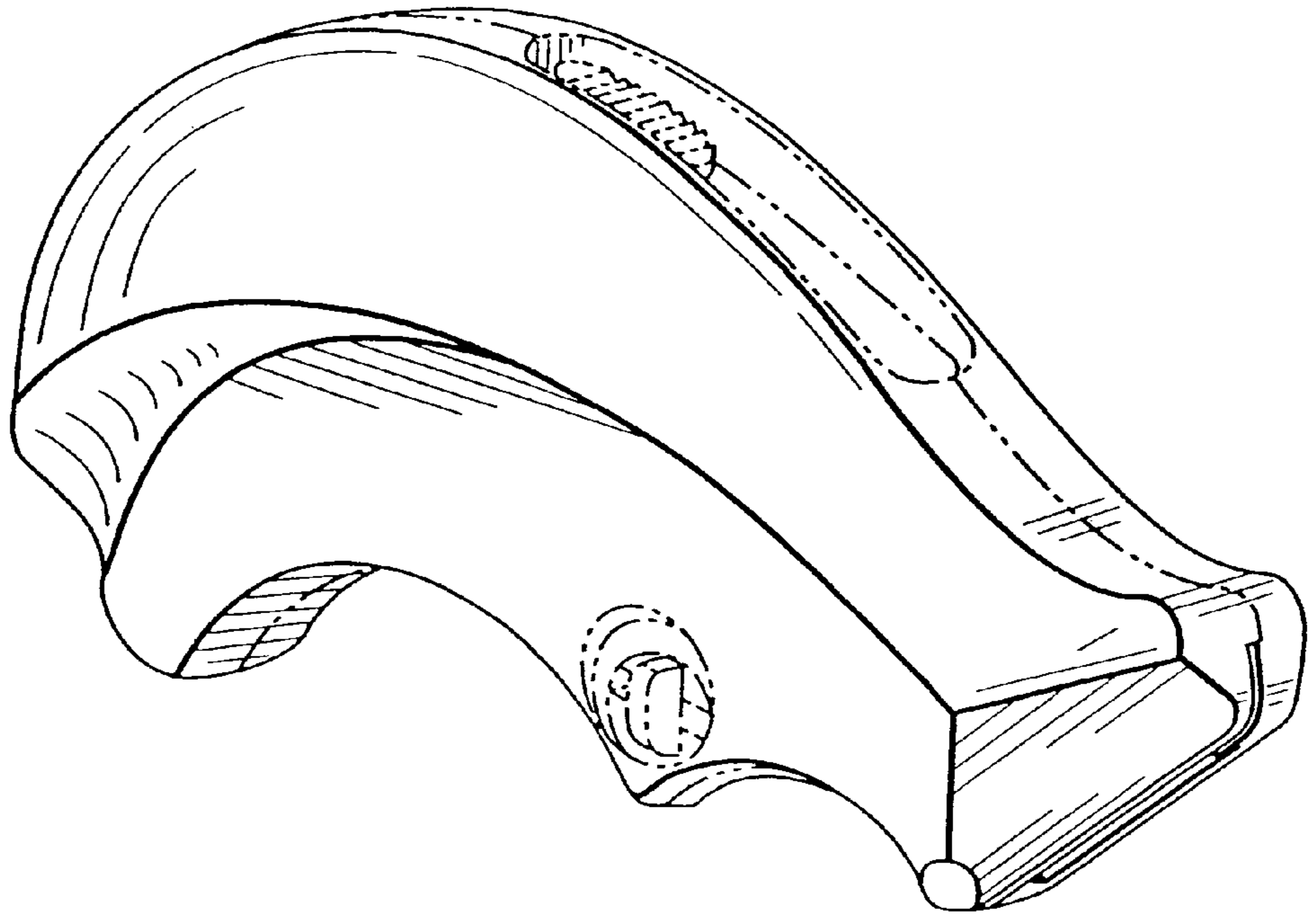

FIG. 16

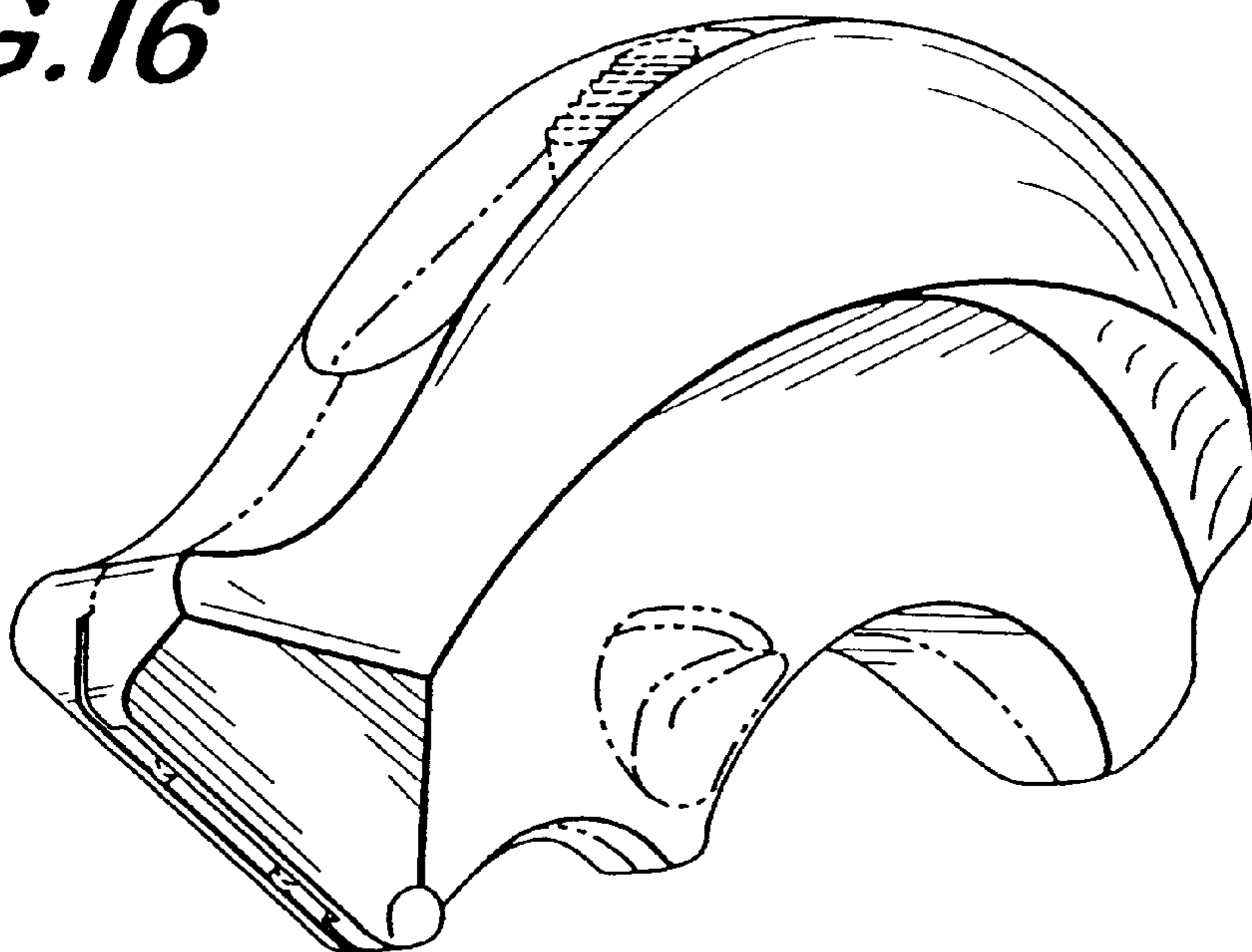

FIG.17

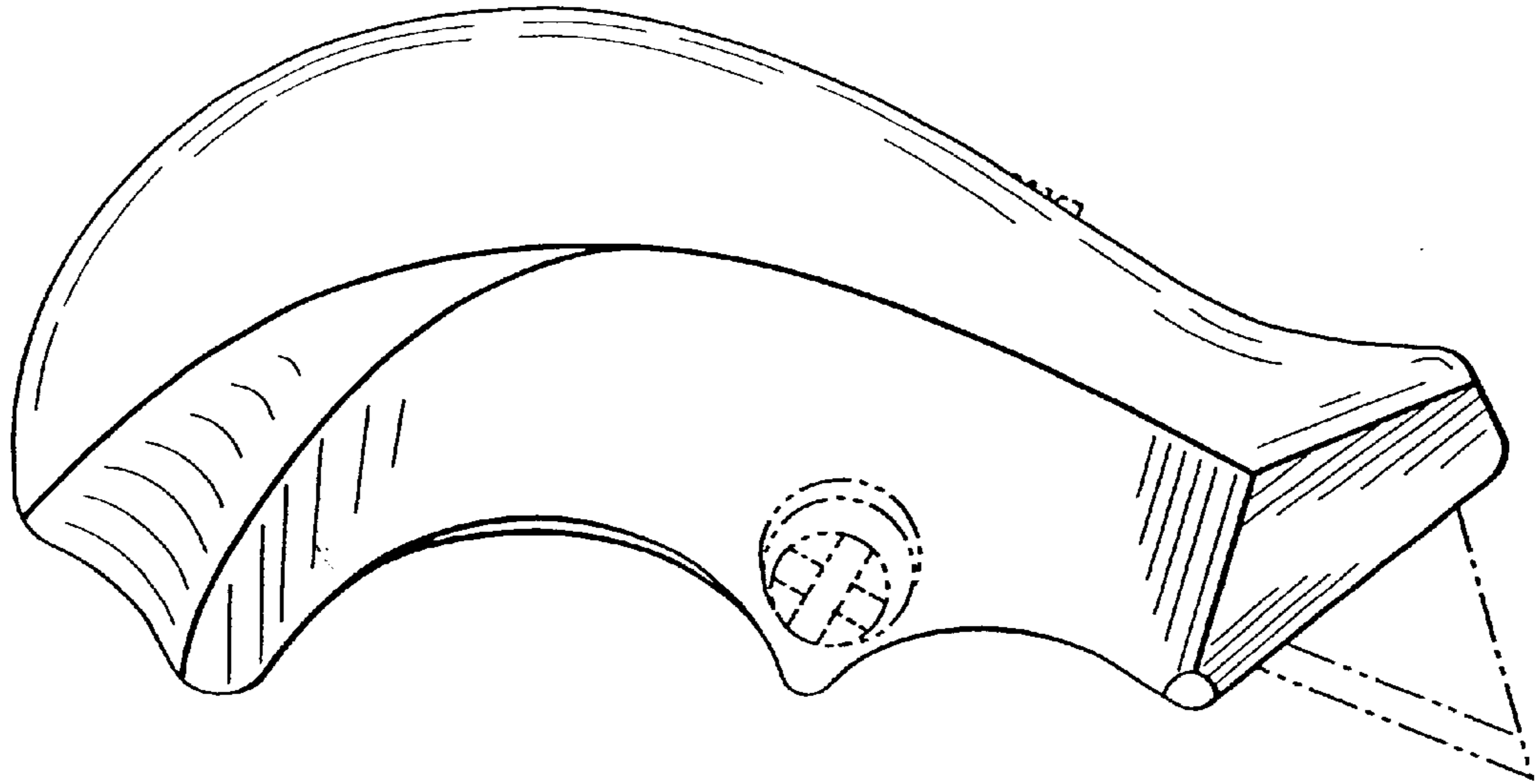

FIG.18

