



US00D439471S

(12) **United States Design Patent**
Gee

(10) **Patent No.:** **US D439,471 S**

(45) **Date of Patent:** **** Mar. 27, 2001**

(54) **CEREAL BOWL, SHELF AND COVER ASSEMBLY**

(76) **Inventor:** **Terry W. Gee**, 547 Harton Cir.,
Virginia Beach, VA (US) 23452

(**) **Term:** **14 Years**

(21) **Appl. No.:** **29/091,328**

(22) **Filed:** **Jul. 28, 1998**

(51) **LOC (7) Cl.** **07-01**

(52) **U.S. Cl.** **D7/505; D7/555**

(58) **Field of Search** D7/505, 538, 541,
D7/555, 356, 601, 602, 614; D9/429, 423,
629, 428; 220/421, 669; 206/562, 507;
215/255, 320

(56) **References Cited**

U.S. PATENT DOCUMENTS

- D. 231,302 * 4/1974 Joseph et al. D7/507
- D. 286,360 * 10/1986 Trivison D7/507

(List continued on next page.)

Primary Examiner—M. N. Pandozzi

(74) *Attorney, Agent, or Firm*—John F. Carroll, Jr.;
Kimberly A. Chasteen

(57) **CLAIM**

The ornamental design for a cereal bowl, shelf and cover assembly, as shown.

DESCRIPTION

FIG. 1 is a perspective view of my new design in one mode of normal use;

FIG. 2 is a partially exploded perspective view of my design in another mode of use with the cover removed for ease of illustration;

FIG. 3 is an exploded perspective view of my design in another mode of use;

FIG. 4 is a top plan view of the bowl of my design with the cover and shelf removed for ease of illustration;

FIG. 5 is a bottom plan view of the bowl of my design;

FIG. 6 is a top plan view of the bowl of my design with the cover removed for ease of illustration;

FIG. 7 is a left side elevational view of the bowl of my design with the cover and shelf removed for ease of illustration;

FIG. 8 is a right side elevational view of the bowl of my design with the cover and shelf removed for ease of illustration;

FIG. 9 is a front elevational view of the bowl of my design with the cover and shelf removed for ease of illustration;

FIG. 10 is a back elevational view of the bowl of my design with the cover and shelf removed for ease of illustration;

FIG. 11 is a top plan view of the shelf of my design with the cover and bowl removed for ease of illustration;

FIG. 12 is a bottom plan view of the shelf of my design with the cover and bowl removed for ease of illustration;

FIG. 13 is a left side elevational view of the shelf of my design with the cover and bowl removed for ease of illustration;

FIG. 14 is a right side elevational view of the shelf of my design with the cover and bowl removed for ease of illustration;

FIG. 15 is a front elevational view of the shelf of my design with the cover and bowl removed for ease of illustration;

FIG. 16 is a back elevational view of the shelf of my design with the cover and bowl removed for ease of illustration;

FIG. 17 is a top plan view of the cover of my design with the shelf and bowl removed for ease of illustration;

FIG. 18 is a bottom plan view of the cover of my design with the shelf and bowl removed for ease of illustration;

FIG. 19 is a left side elevational view of the cover of my design with the shelf and bowl removed for ease of illustration;

FIG. 20 is a right side elevational view of the cover of my design with the shelf and bowl removed for ease of illustration;

FIG. 21 is a front elevational view of the cover of my design with the shelf and bowl removed for ease of illustration;

FIG. 22 is a back elevational view of the cover of my design with the shelf and bowl removed for ease of illustration;

FIG. 23 is a cross-sectional view of the cereal bowl, shelf and cover assembly taken along line 23—23 of FIG. 1; and,

FIG. 24 is a side elevational view of my design.

1 Claim, 14 Drawing Sheets

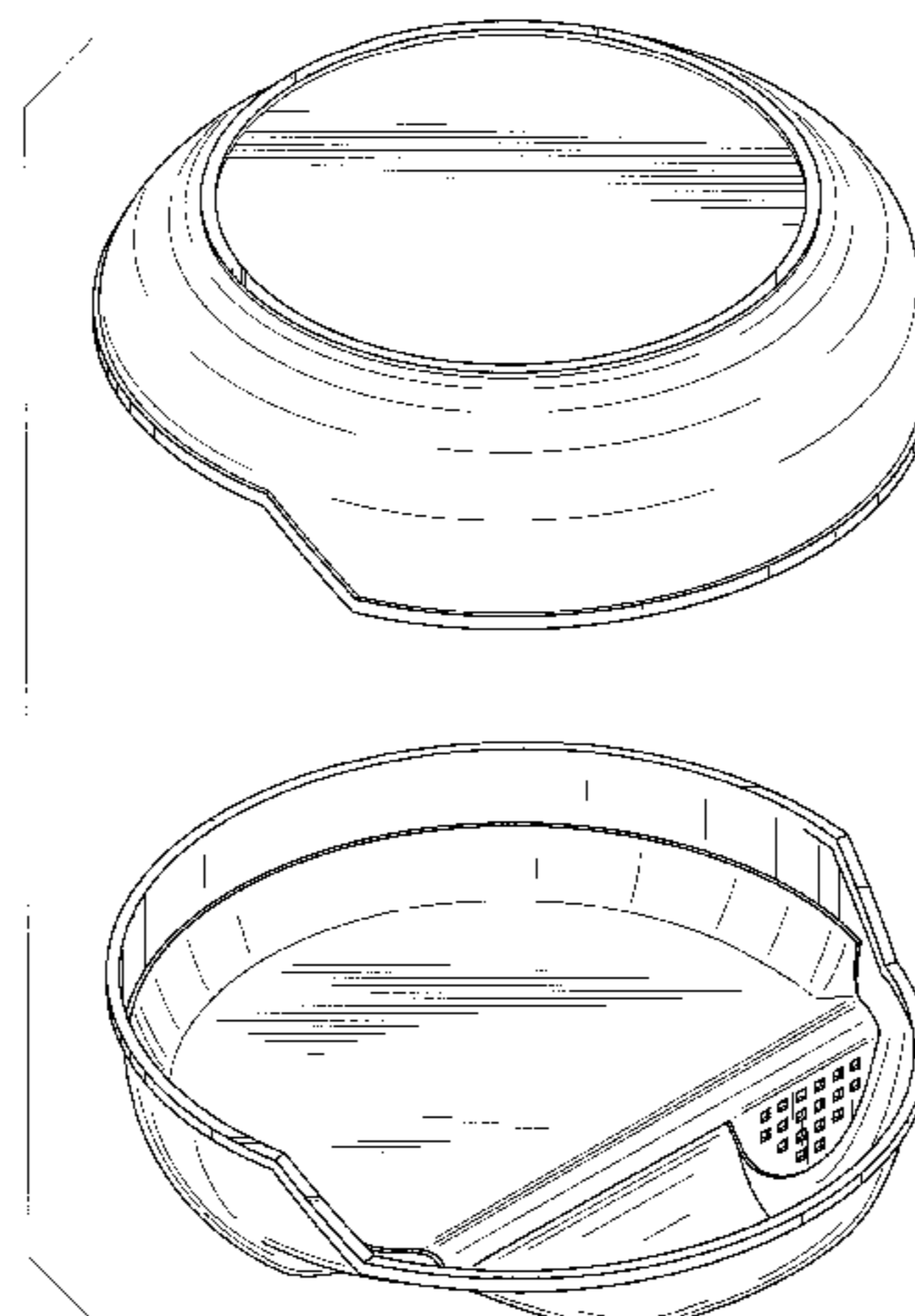

US D439,471 S

Page 2

U.S. PATENT DOCUMENTS

D. 314,307	*	2/1991	Bush	D7/505	D. 381,560	*	7/1997	Indekeu	D7/538
D. 372,862	*	8/1996	Fiori	D9/428	D. 382,175	*	8/1997	Green	D7/538
D. 373,704	*	9/1996	Doxey	D7/391	4,174,039	*	11/1979	Frankhuizen	206/507 X
D. 379,901	*	6/1997	Lillelund et al.	D7/505						

* cited by examiner

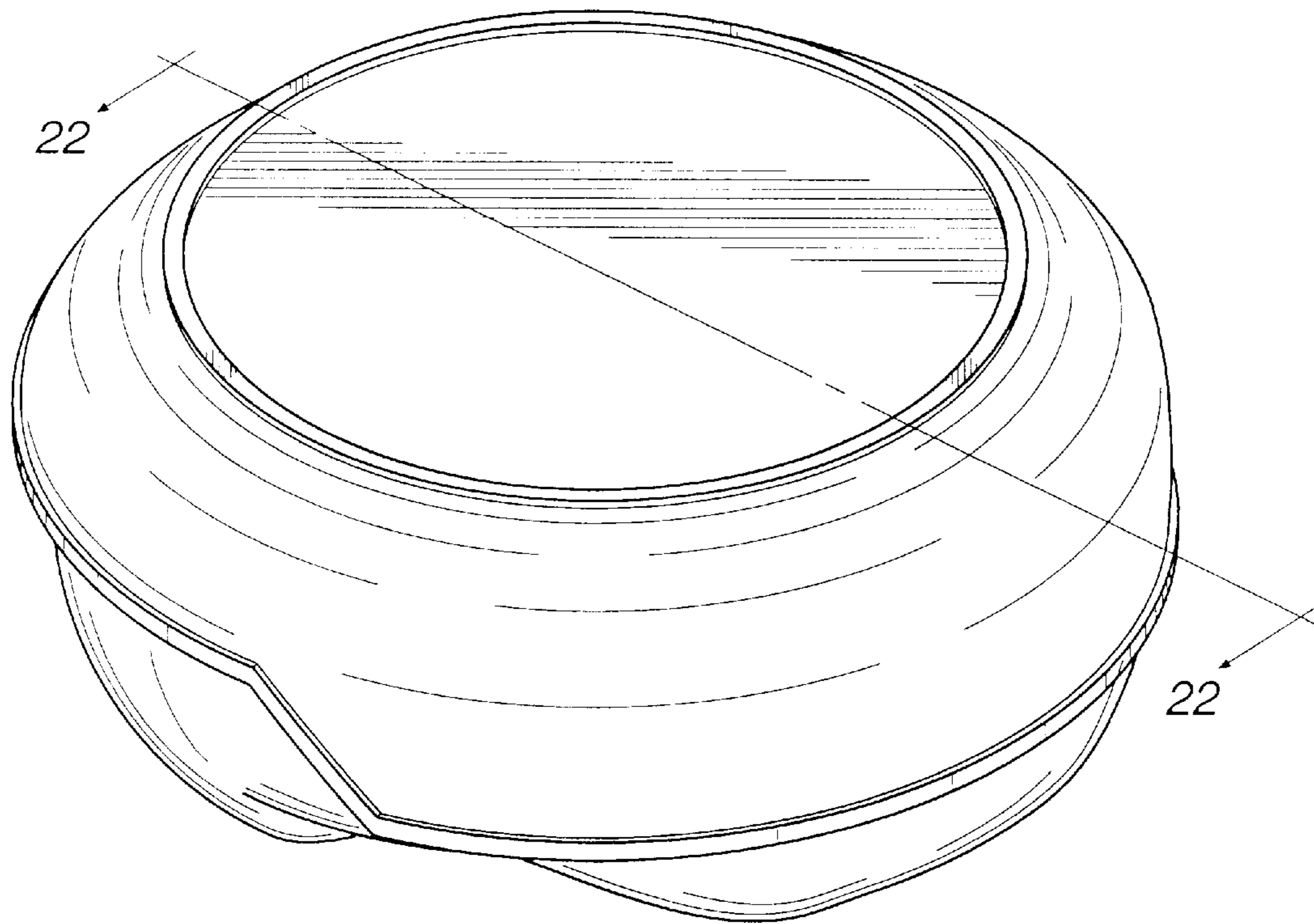

FIG. 1

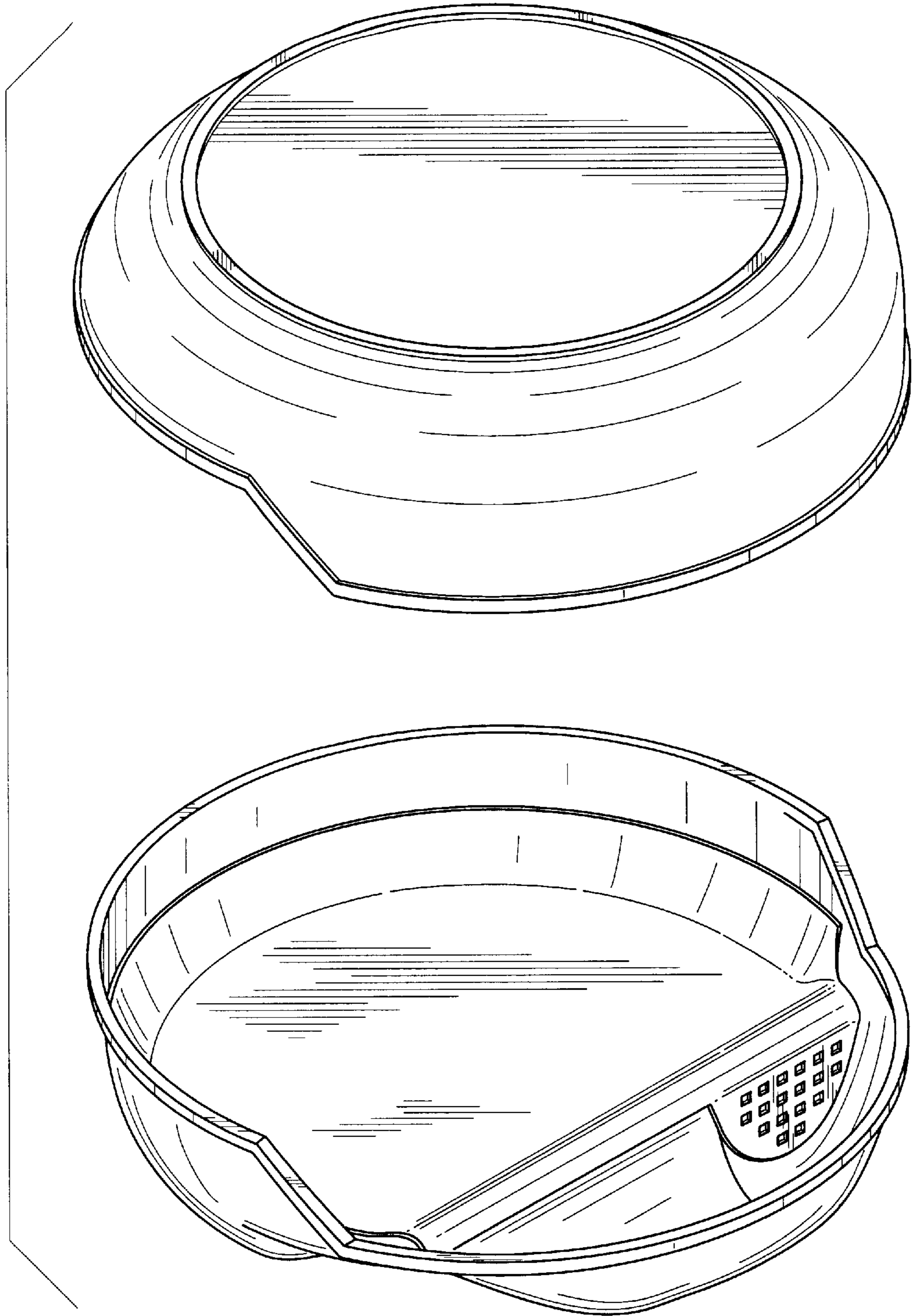

FIG. 2

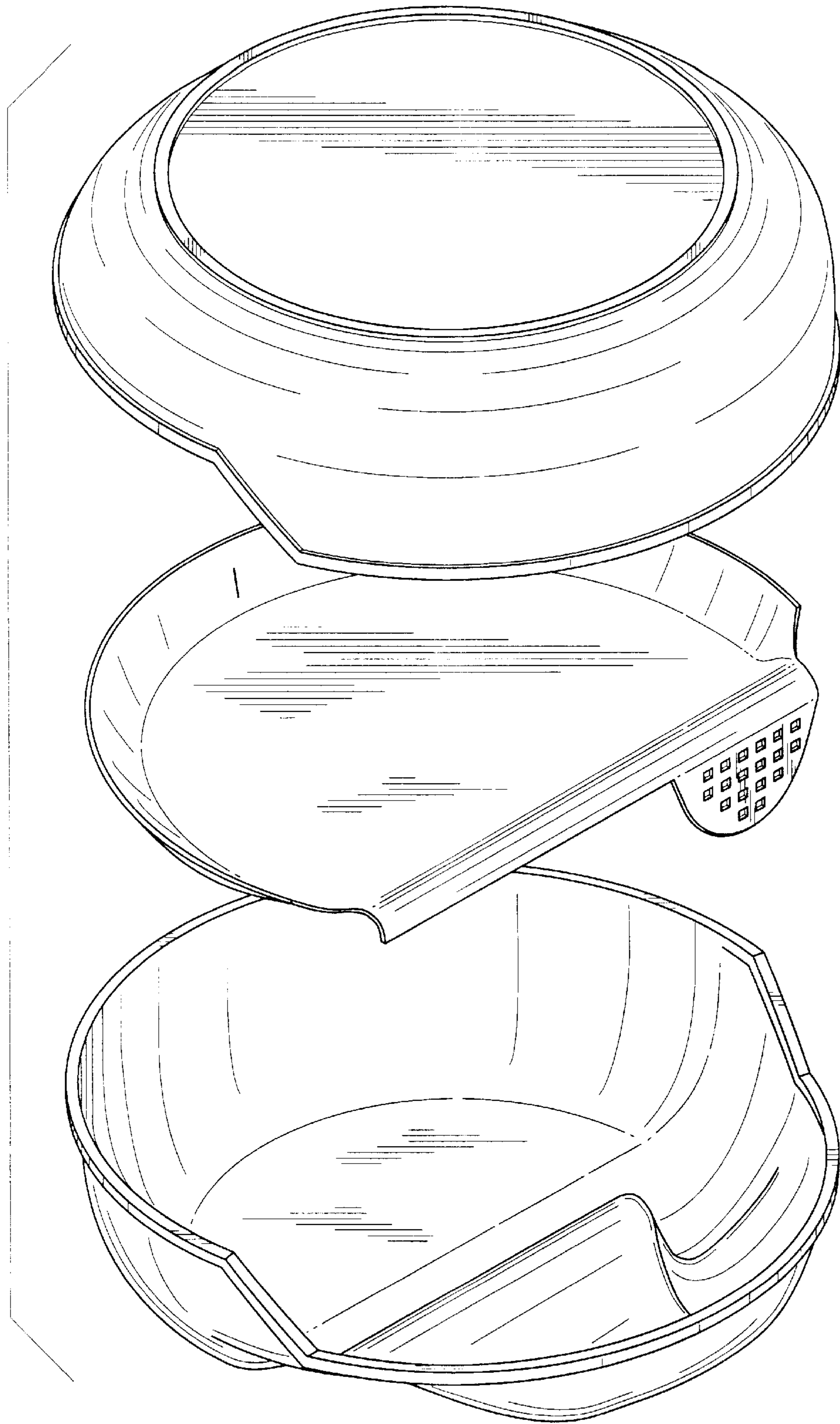

FIG. 3

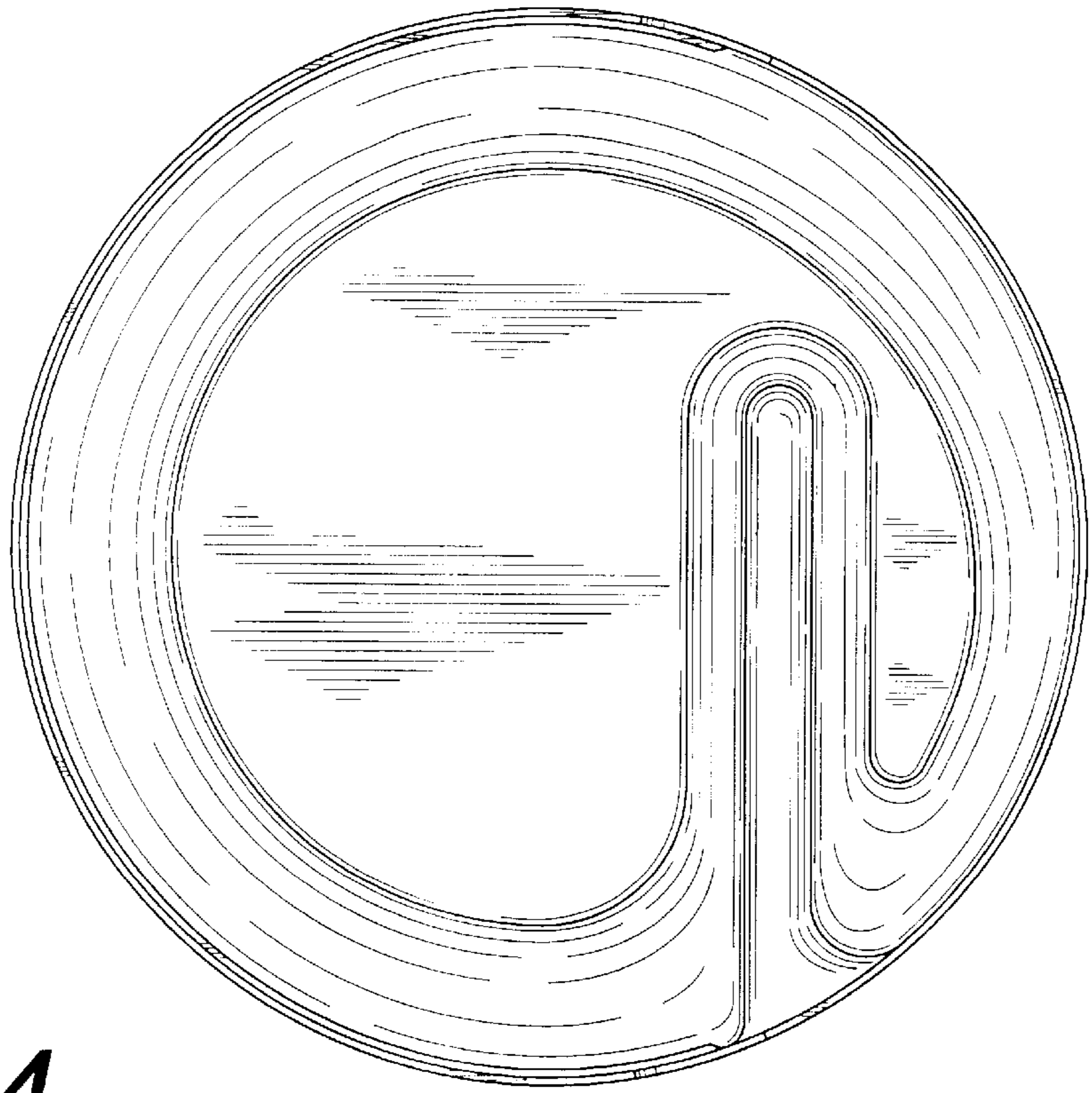

FIG. 4

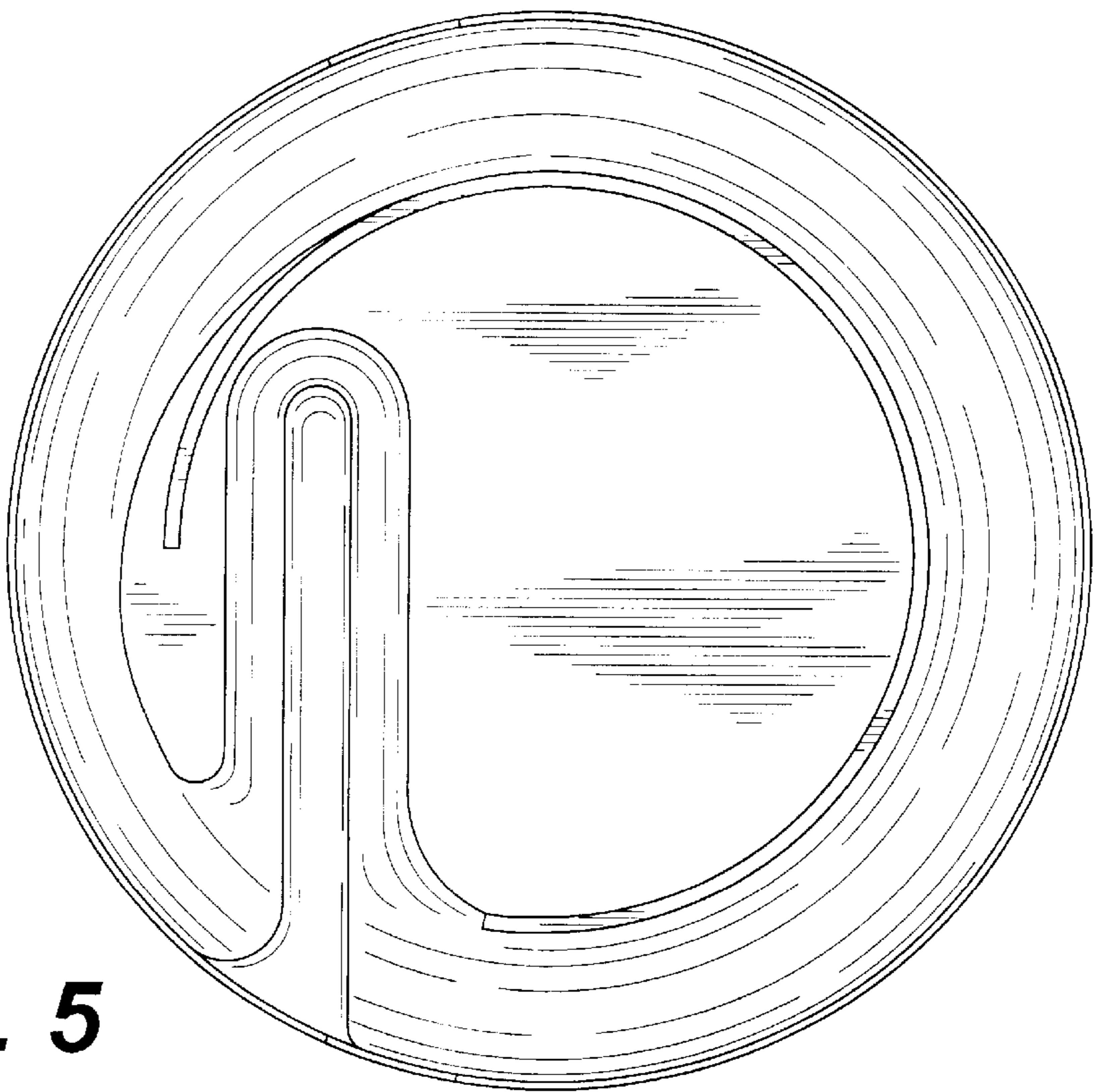

FIG. 5

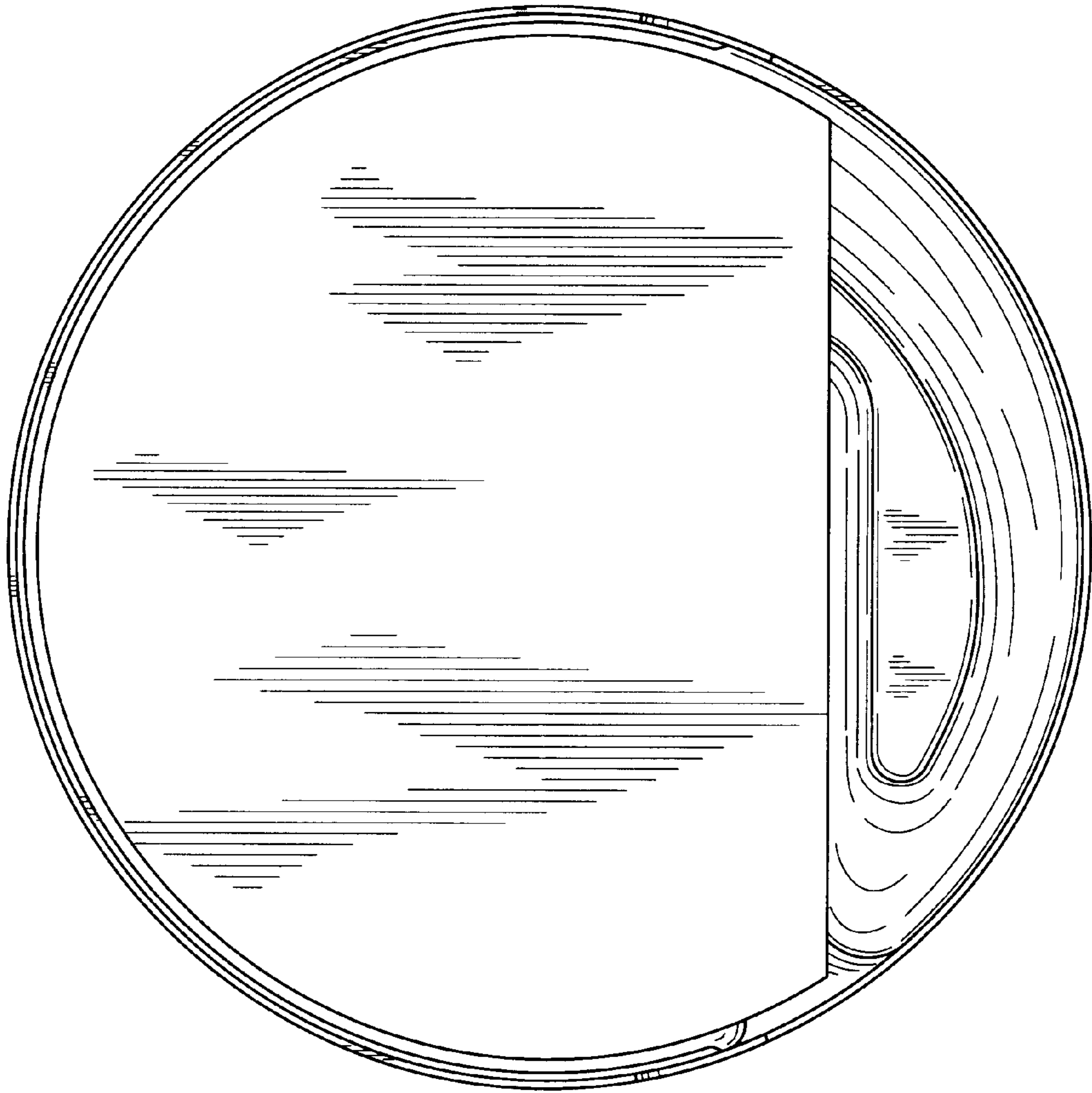

FIG. 6

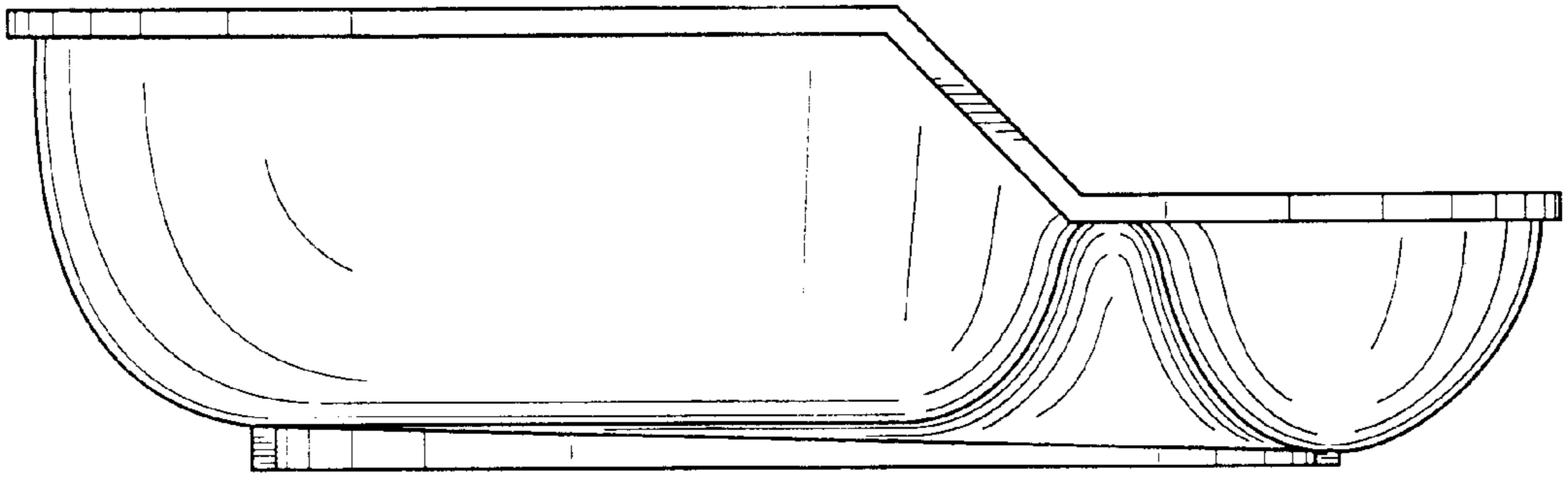

FIG. 7

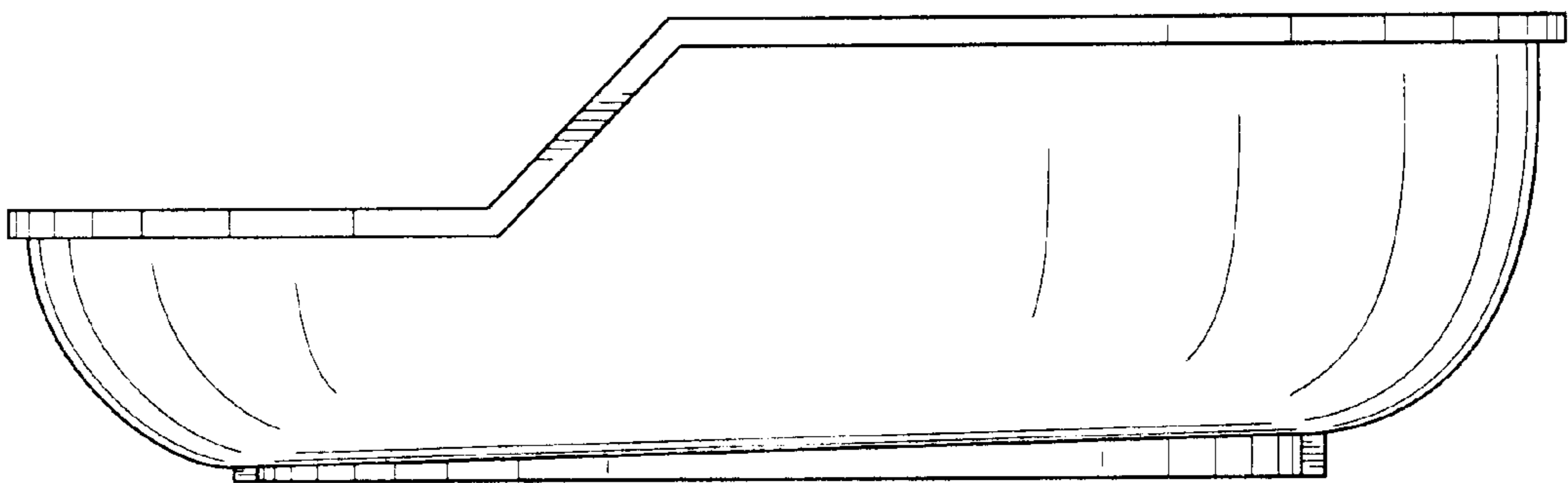

FIG. 8

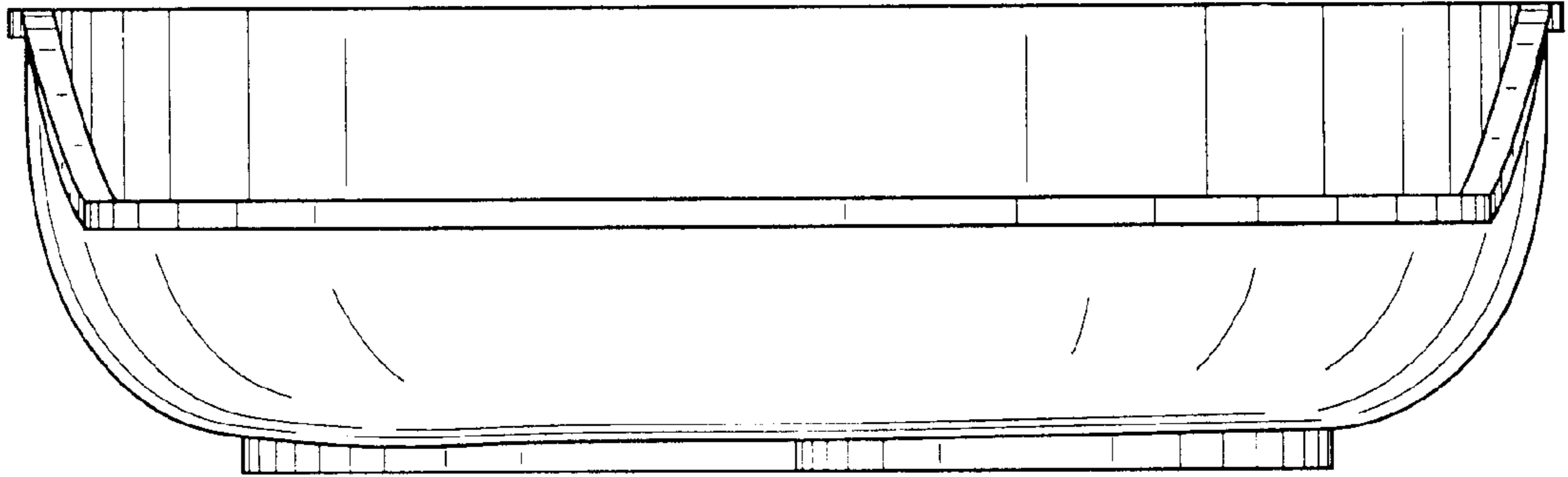

FIG. 9

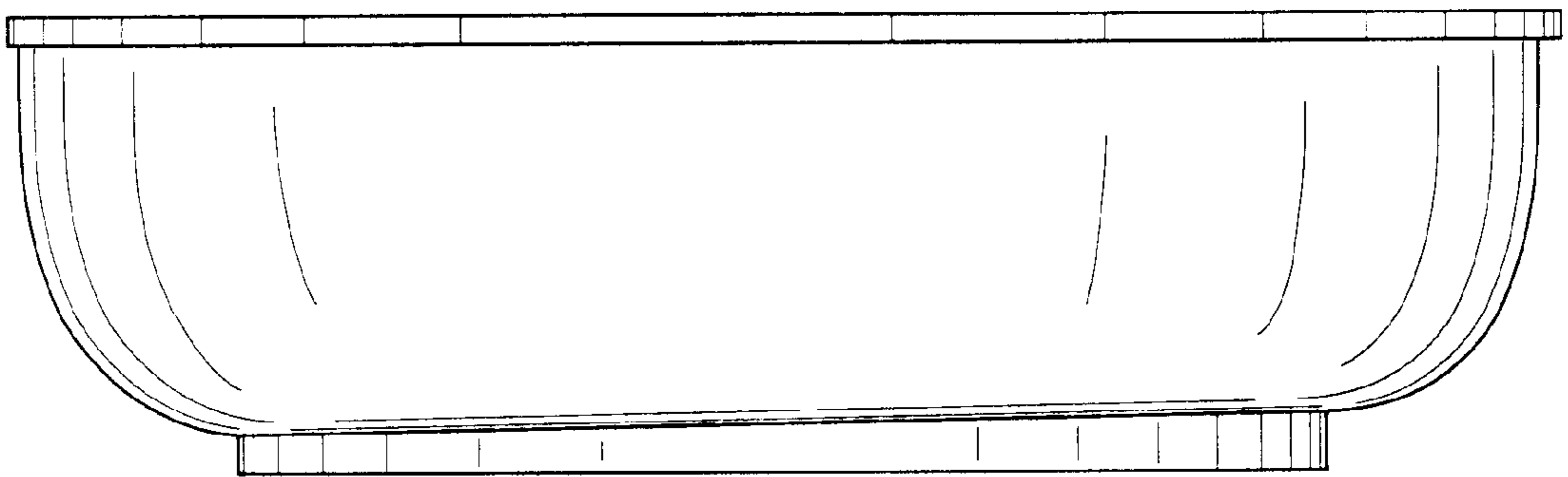

FIG. 10

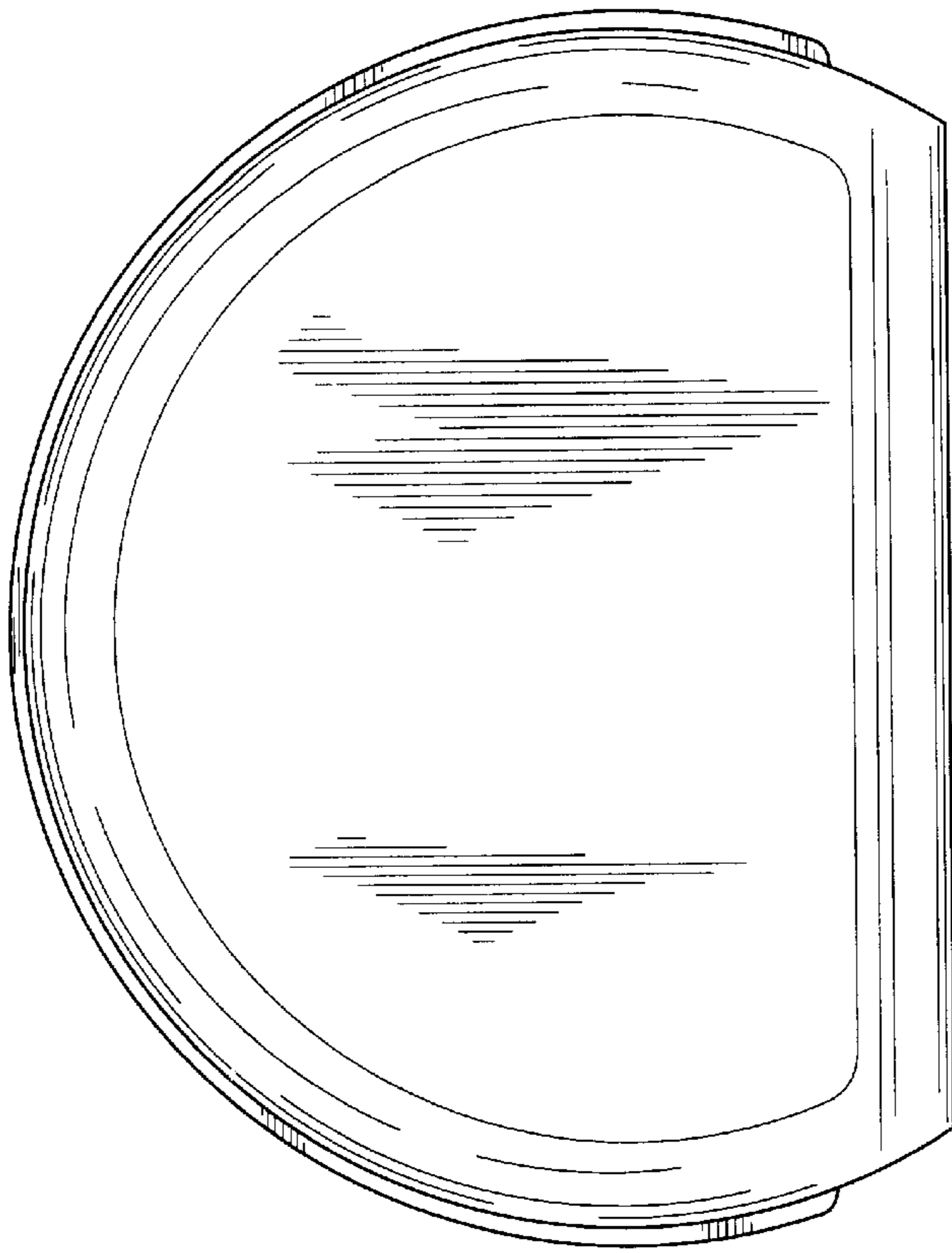

FIG. 11

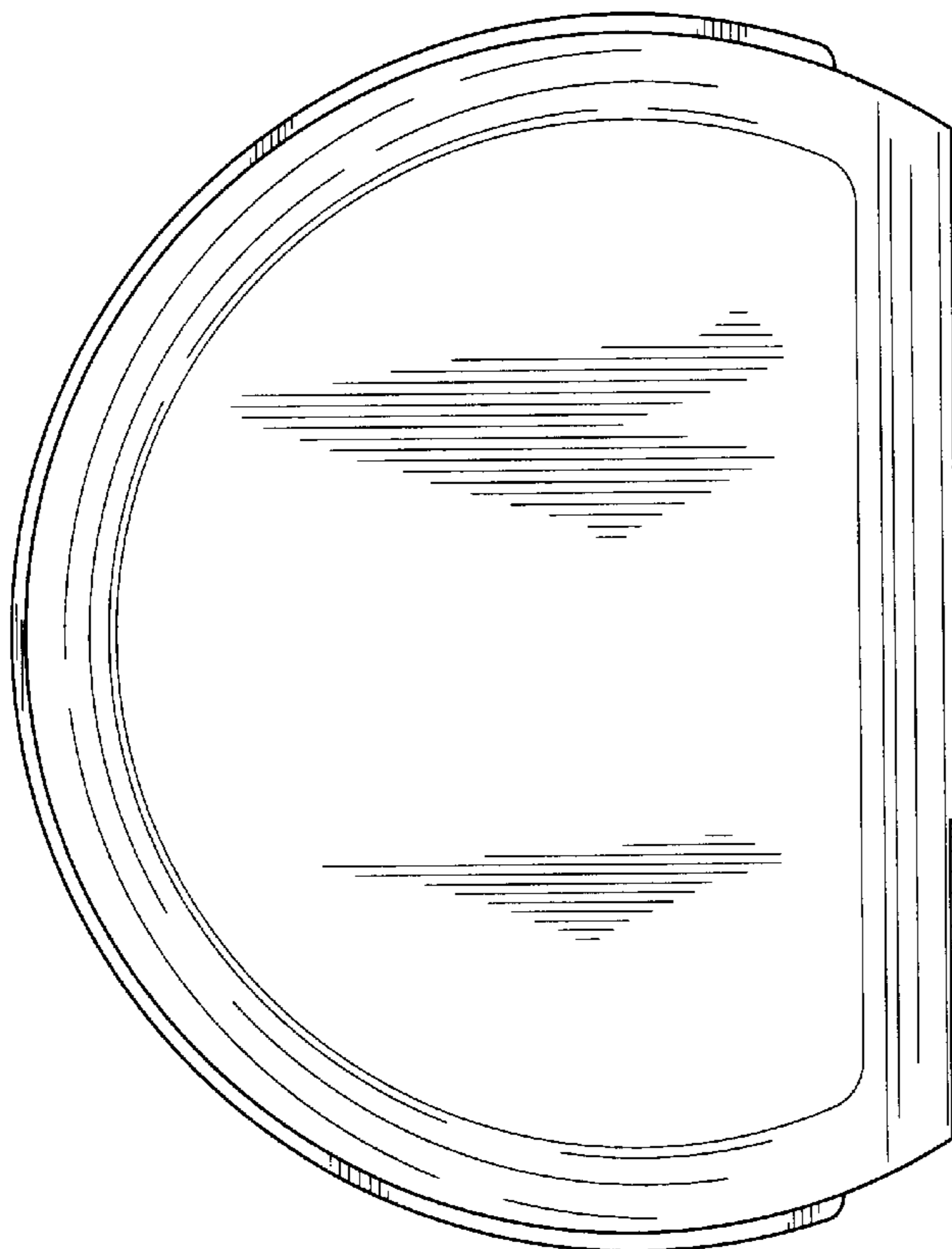

FIG. 12

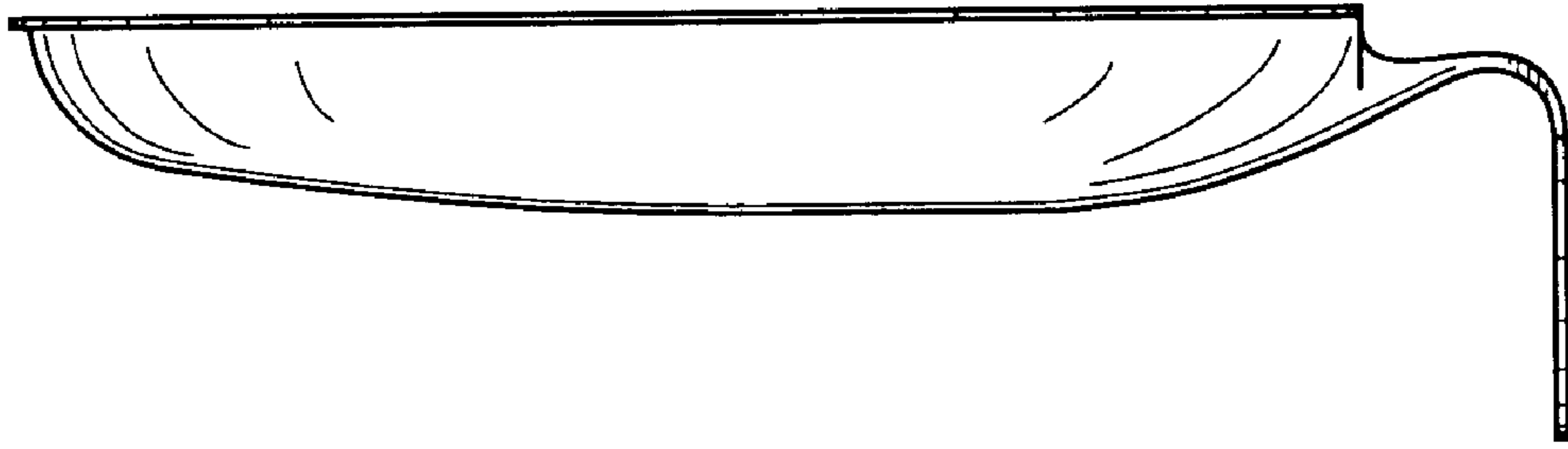

FIG. 13

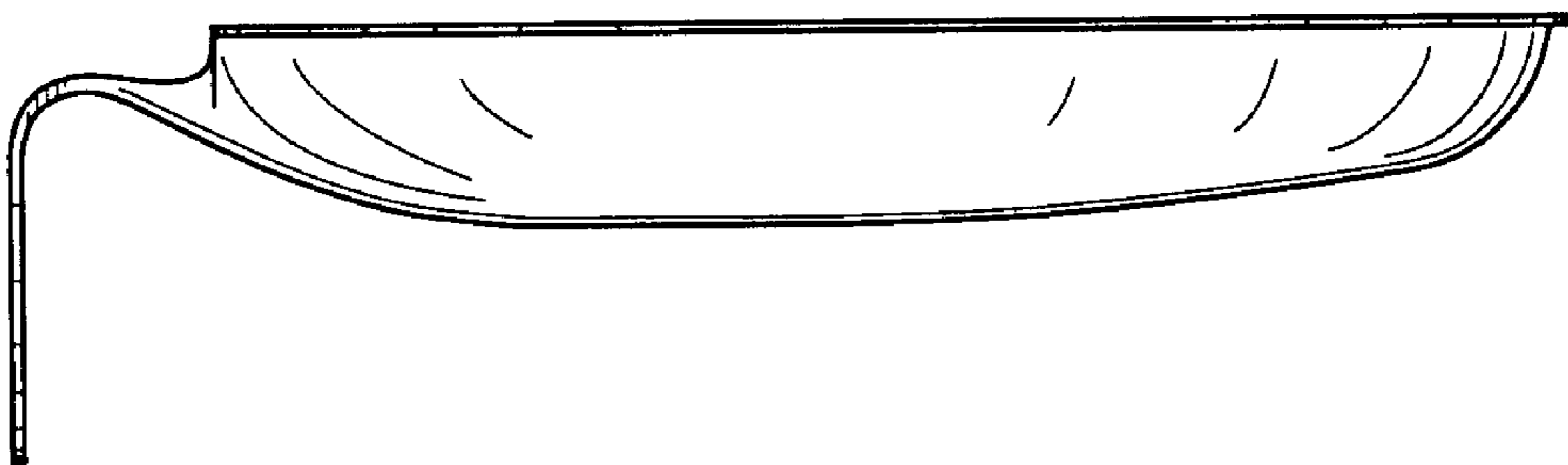

FIG. 14

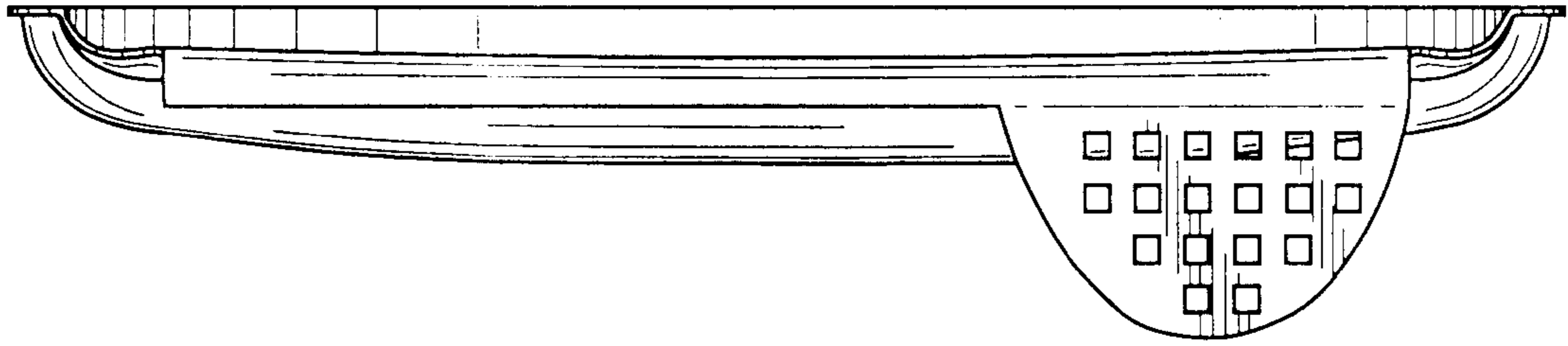

FIG. 15

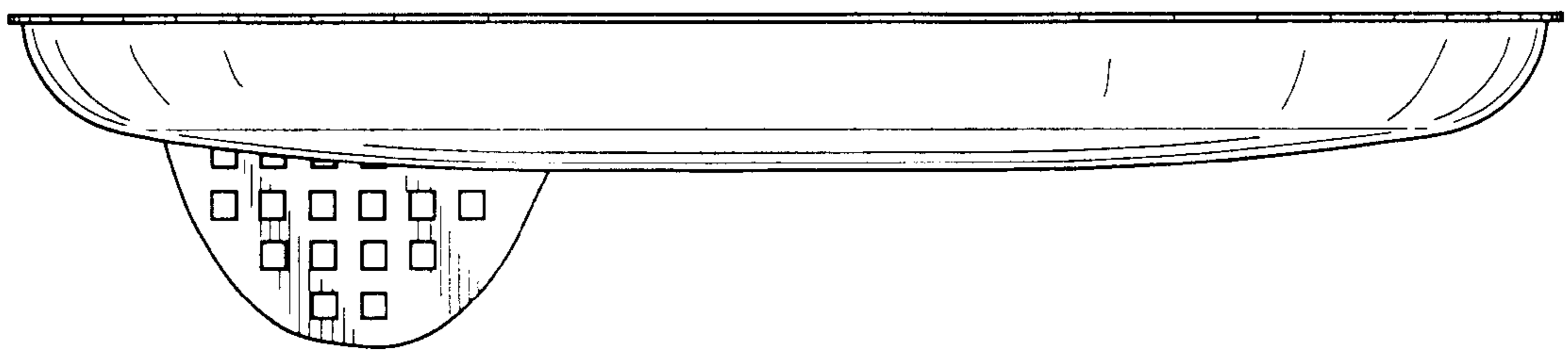

FIG. 16

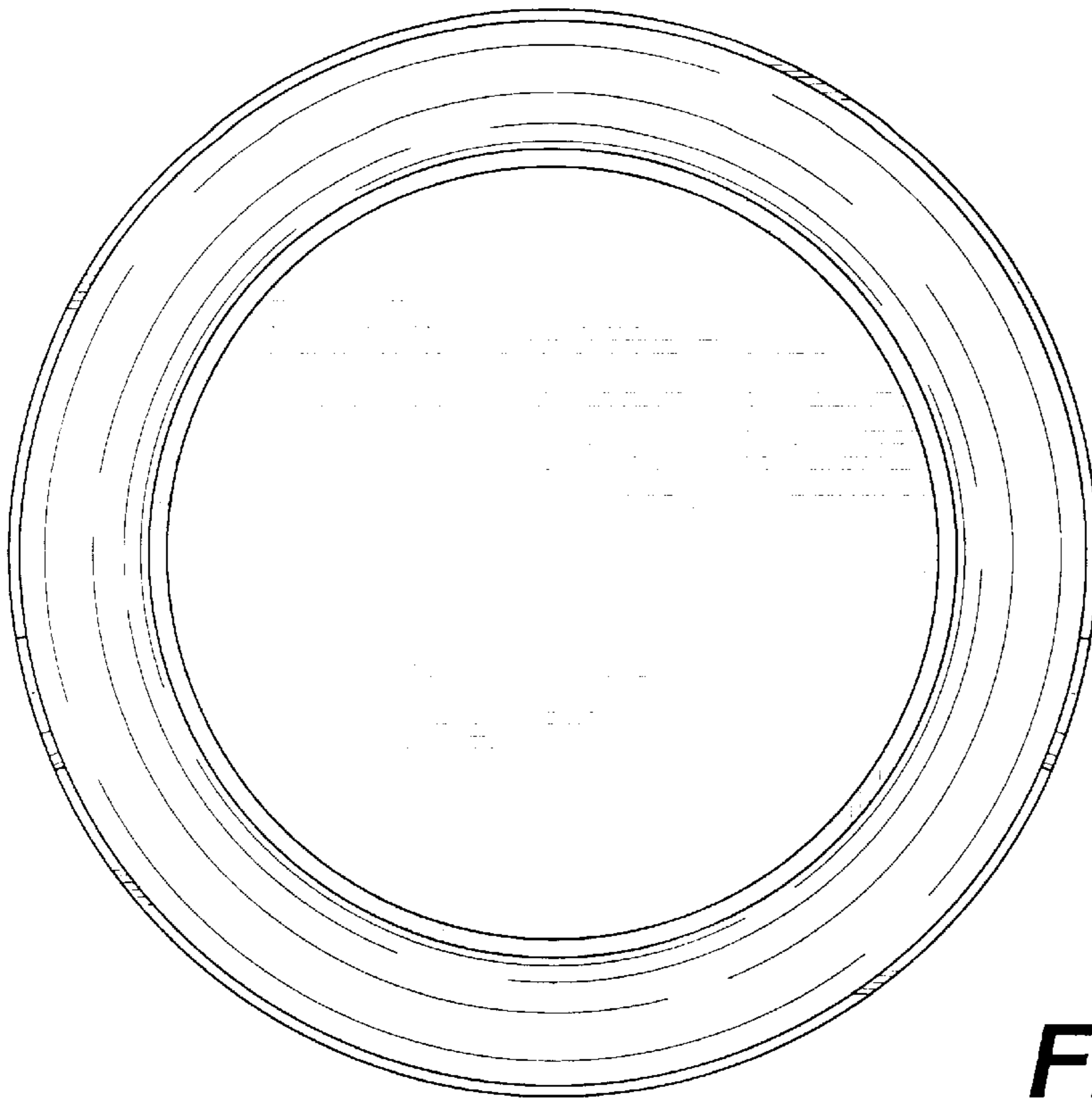

FIG. 17

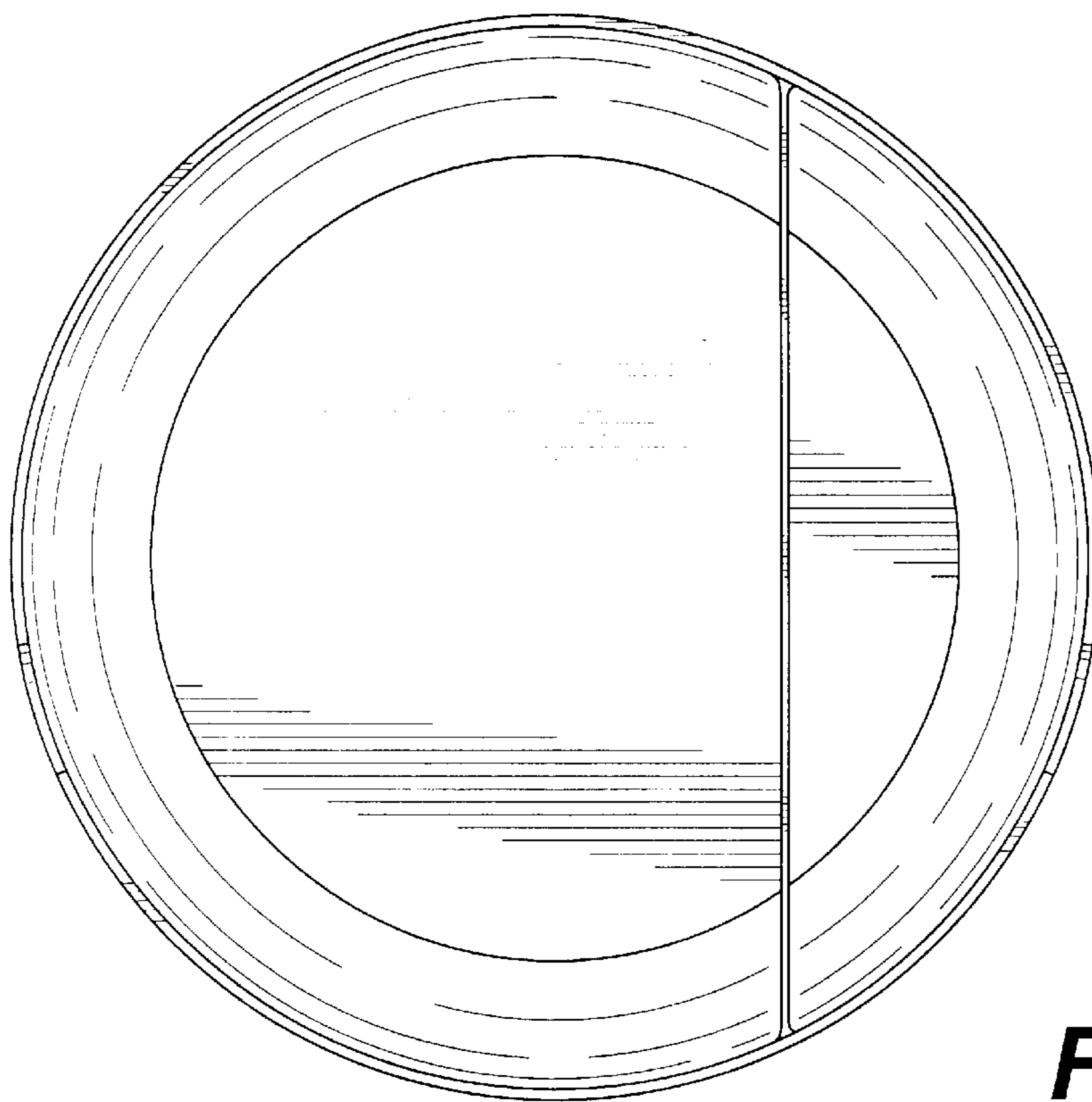

FIG. 18

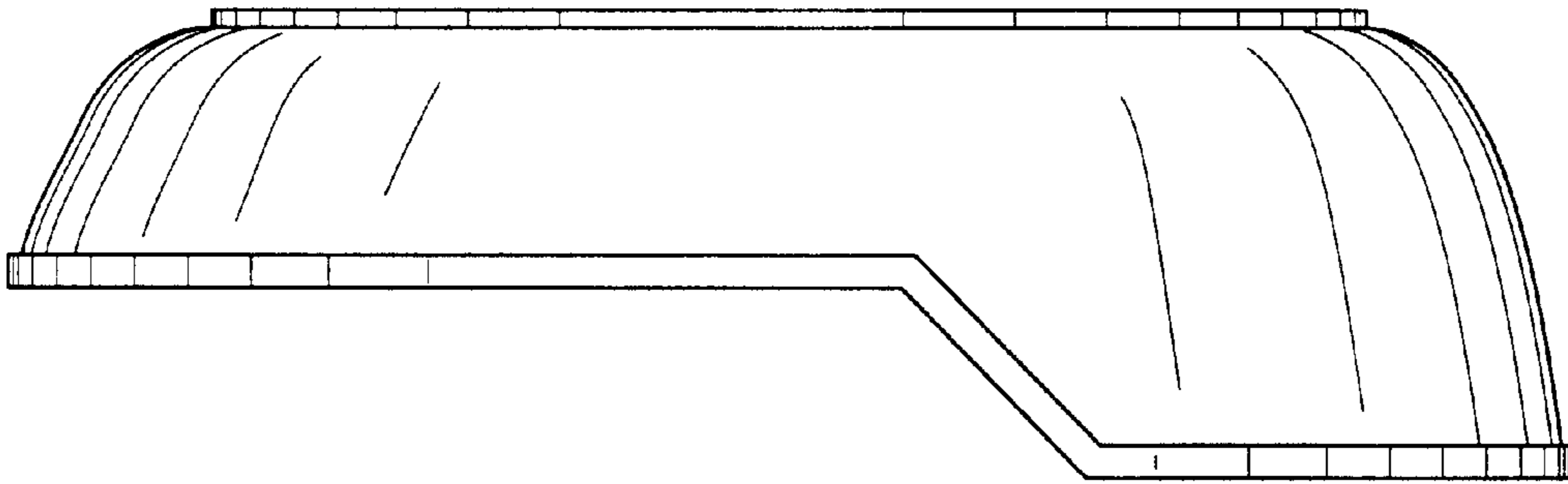

FIG. 19

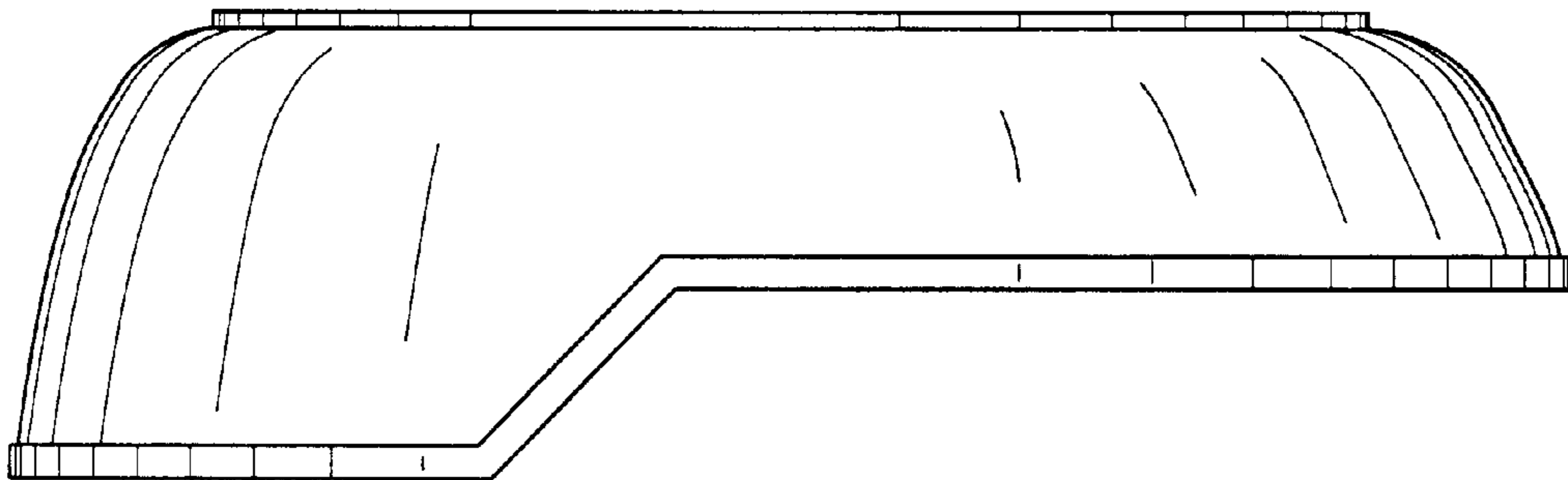

FIG. 20

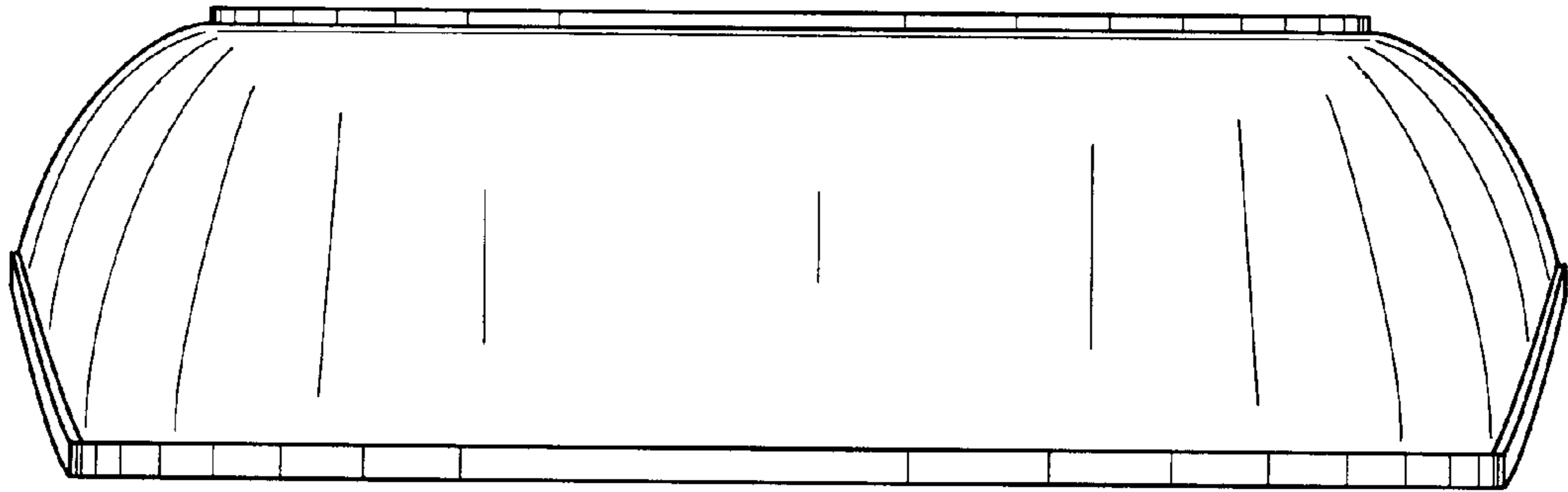

FIG. 21

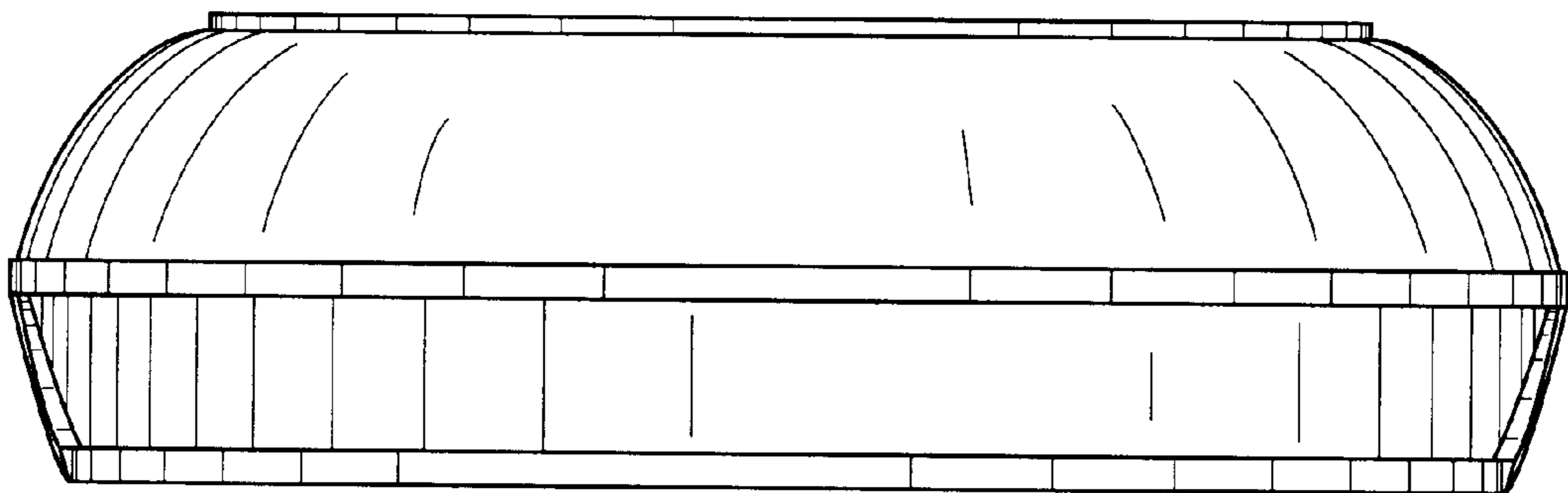

FIG. 22

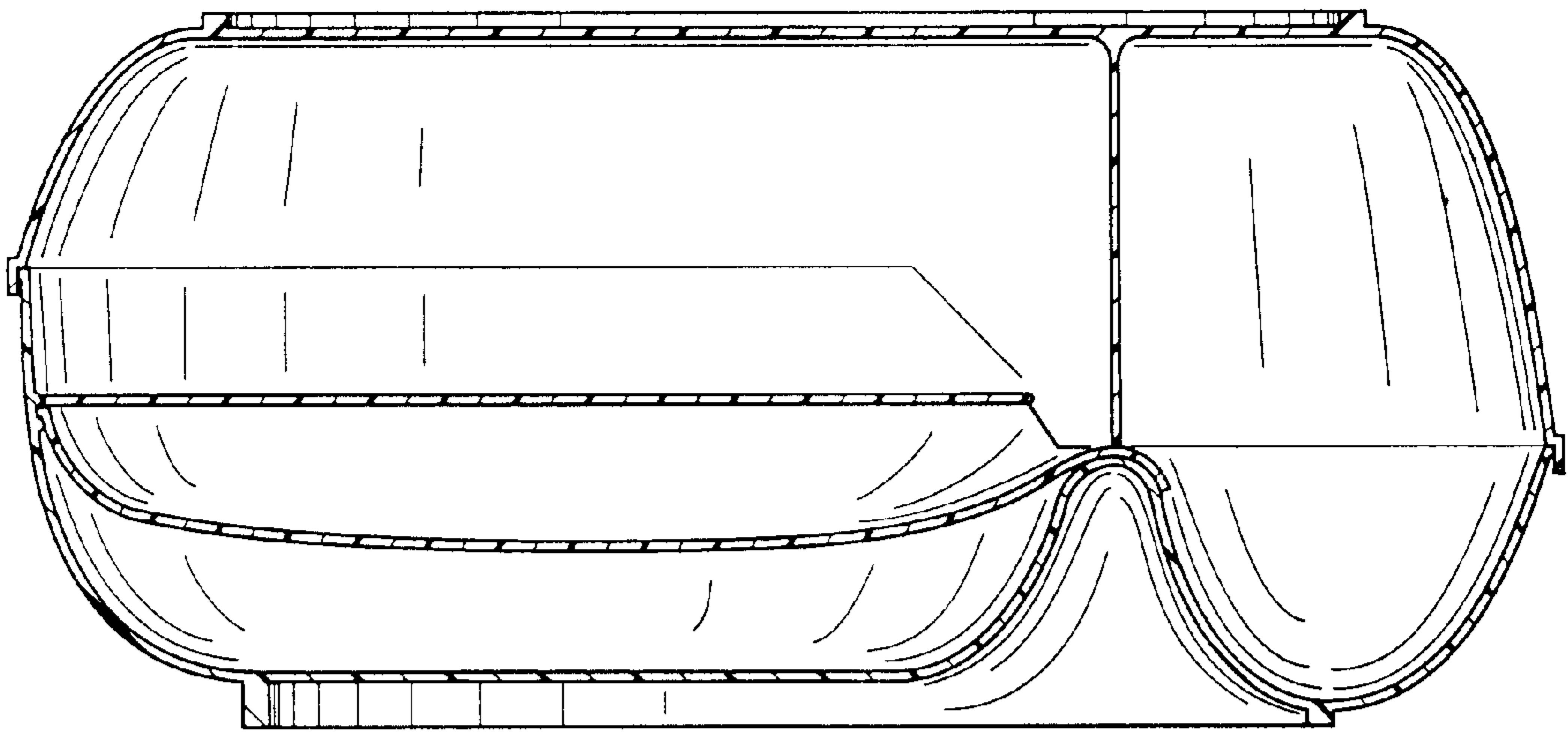

FIG. 23

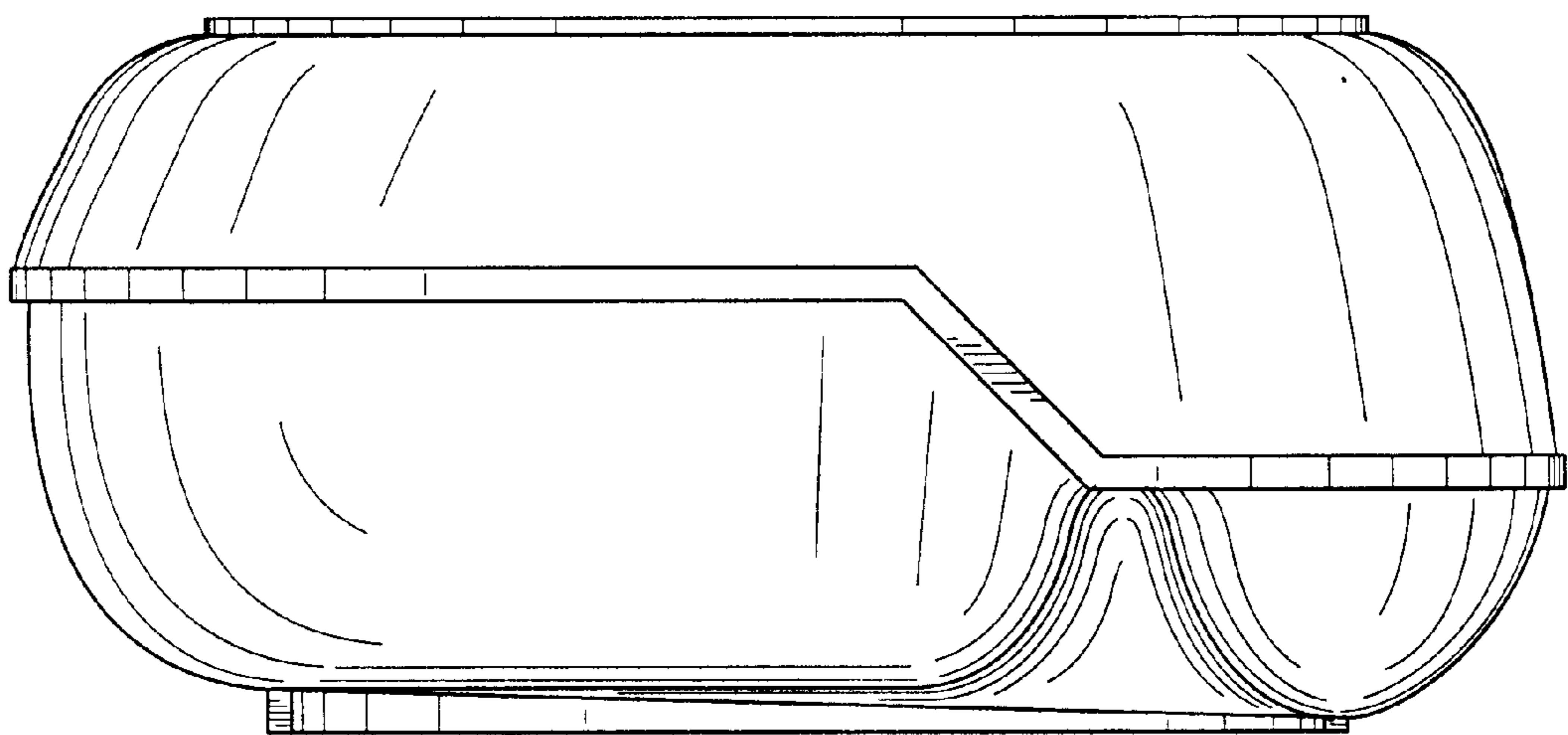

FIG. 24