



US00D439425S

(12) **United States Design Patent**
Park et al.

(10) **Patent No.:** **US D439,425 S**

(45) **Date of Patent:** **** Mar. 27, 2001**

(54) **AIRLINE SEAT**

5-13838 2/1993 (JP) .
96/18537 6/1996 (WO) .

(75) Inventors: **James William Park; Philip Haith,**
both of London (GB)

OTHER PUBLICATIONS

(73) Assignee: **Singapore Airlines Limited,** Singapore
(SG)

“Inflight,” In This Issue, vol. 1, No. 1, Oct. 1994, pp. 18–20.
“Business and Commercial Aviation,” Dec. 1986, pp. 5–6.

(**) Term: **14 Years**

* cited by examiner

(21) Appl. No.: **29/094,376**

Primary Examiner—Doris V. Coles

Assistant Examiner—Mimosa De

(22) Filed: **Sep. 30, 1998**

(74) *Attorney, Agent, or Firm*—Howrey Simon Arnold &
White, LLP

(51) **LOC (7) Cl.** **06-01**

(57) **CLAIM**

(52) **U.S. Cl.** **D6/356**

The ornamental design for an airline seat, as shown and
described.

(58) **Field of Search** D6/334, 335, 336,
D6/356, 360, 361, 367, 368, 377, 381,
500–502; 297/170, 172, 174, 232, 452.14,
452.34; D12/345

DESCRIPTION

(56) **References Cited**

U.S. PATENT DOCUMENTS

D. 251,761 * 5/1979 Long D6/334
D. 269,652 * 7/1983 McKean et al. D6/356
D. 364,508 * 11/1995 Pryor et al. D6/356
D. 402,125 * 12/1998 Dryburgh et al. D6/335
D. 405,275 * 2/1999 Dryburgh et al. D6/335
D. 409,010 * 5/1999 Papaioannou et al. D6/356

FIG. 1 is a top perspective view of the airline seat, showing
our new design;

FIG. 2 is a top perspective view of the airline seat with the
table extended and television monitor in the up position;

FIG. 3 is a top perspective view of the airline seat in a bed
position;

FIG. 4 is a top plan view of the airline seat with the table
extended;

FIG. 5 is a rear elevation view;

FIG. 6 is a side elevation view of the airline seat with the
table extended and with the television monitor in the up
position;

FIG. 7 is a front elevation view; and,

FIG. 8 is a side elevation view of the side opposite of that
shown in FIG. 6, with the table extended.

The broken line showing the symbol on the back rest in FIG.
5 is for illustrative purposes only and forms no part of the
claimed design.

FOREIGN PATENT DOCUMENTS

714911 12/1941 (DE) .
248373 12/1987 (EP) .
647809 12/1928 (FR) .
633308 12/1949 (GB) .
2094621 3/1982 (GB) .
2050443 6/1996 (GB) .
2050444 6/1996 (GB) .
2050442 12/1996 (GB) .
2070694 4/1998 (GB) .

1 Claim, 8 Drawing Sheets

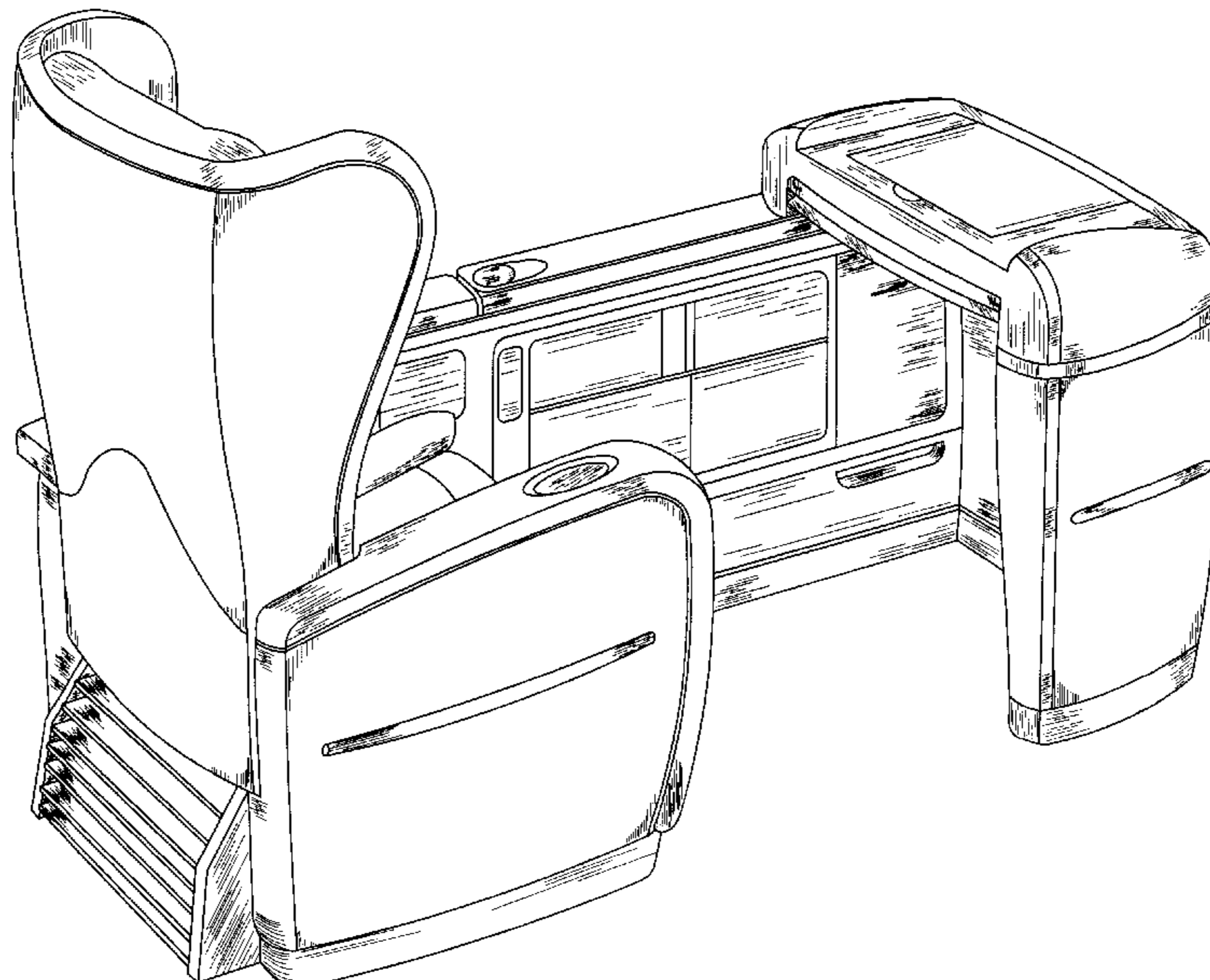

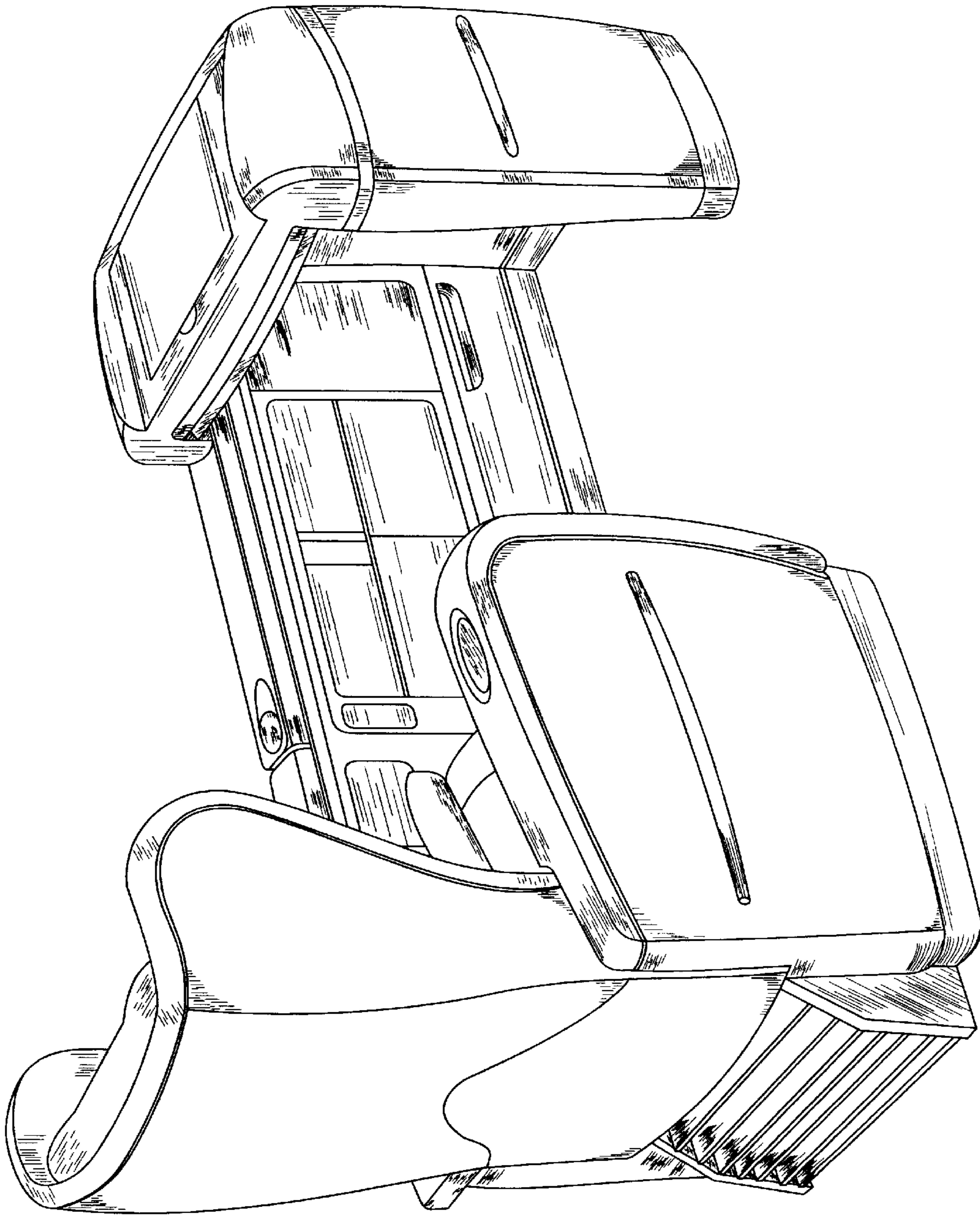

FIG. 1

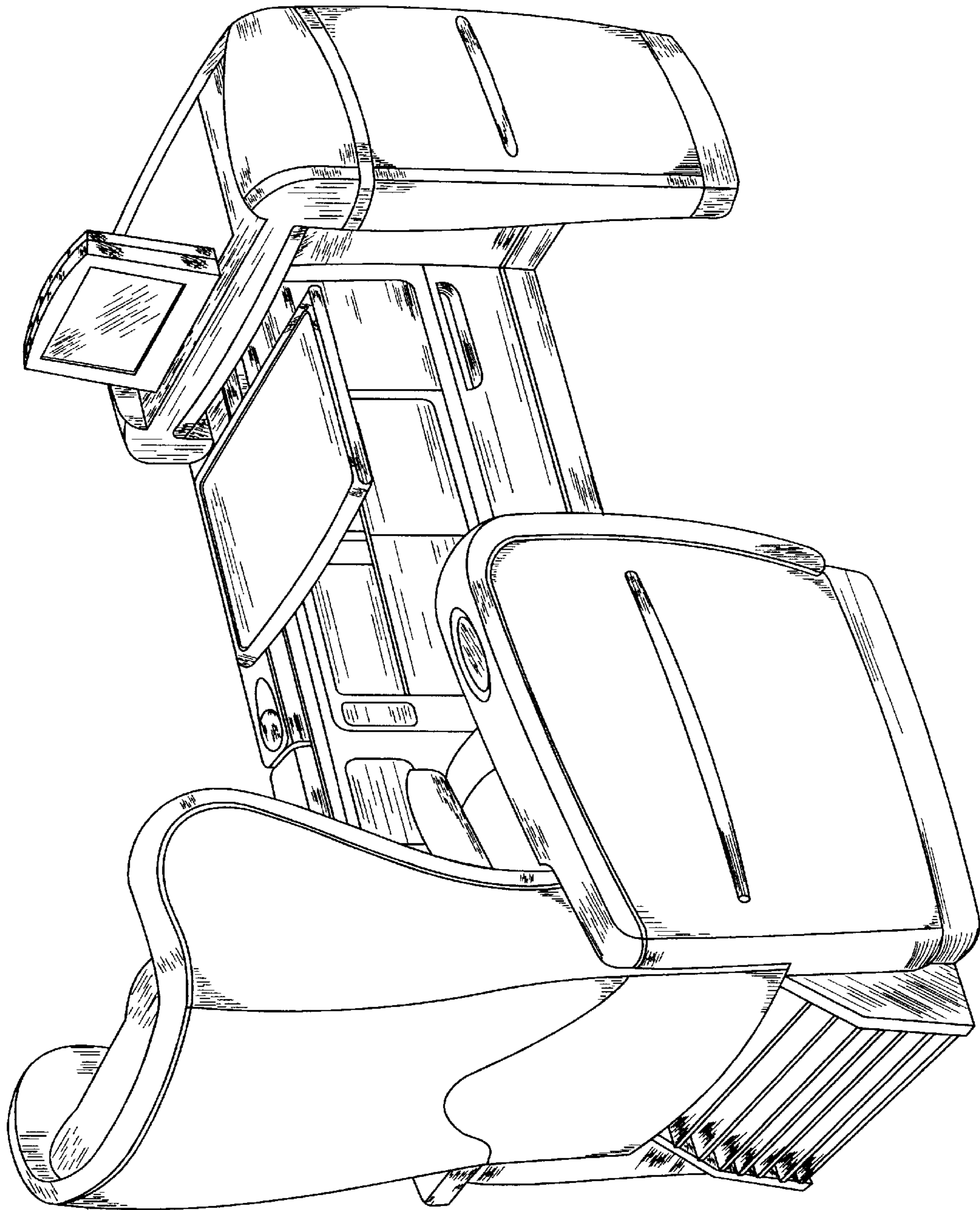

FIG. 2

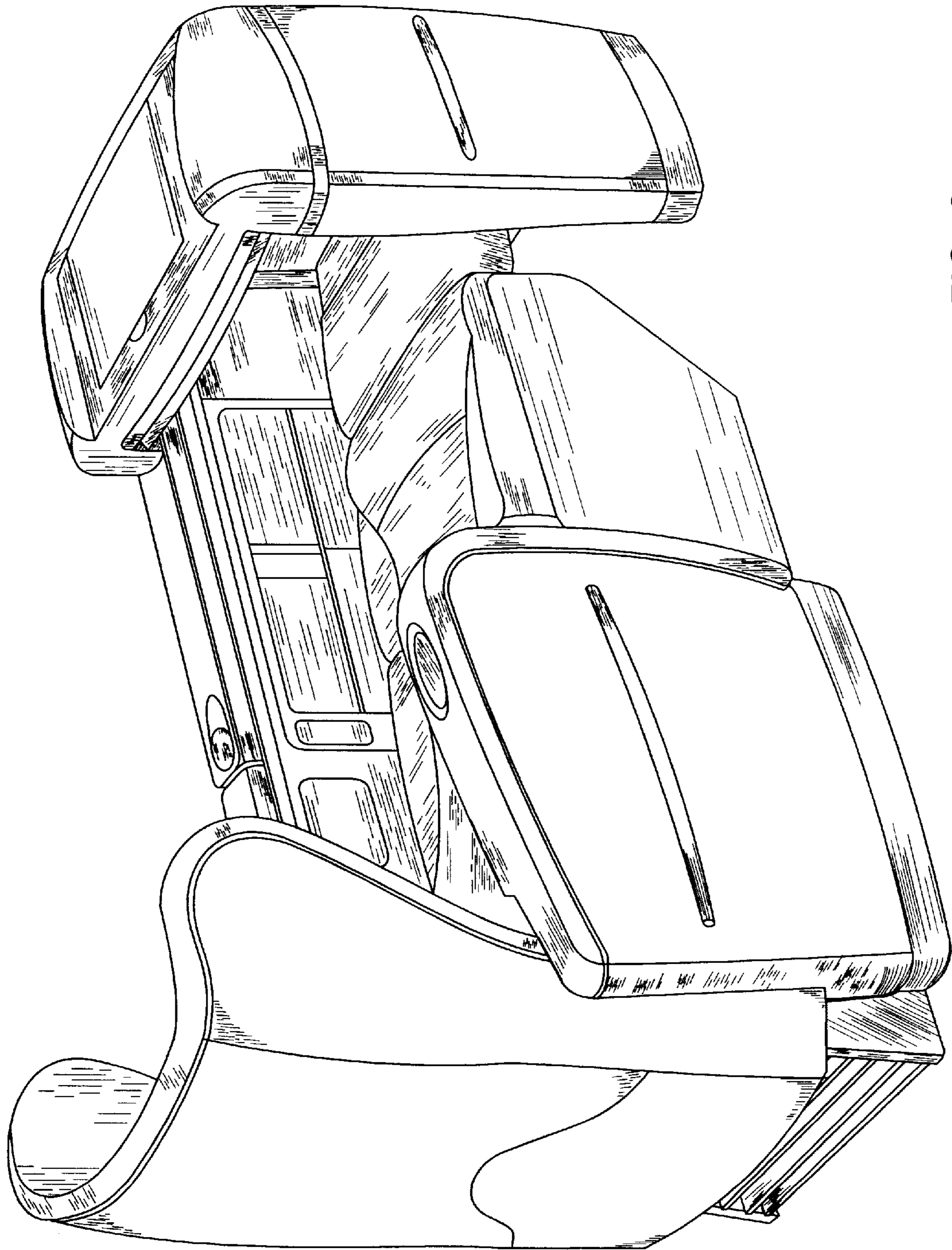

FIG. 3

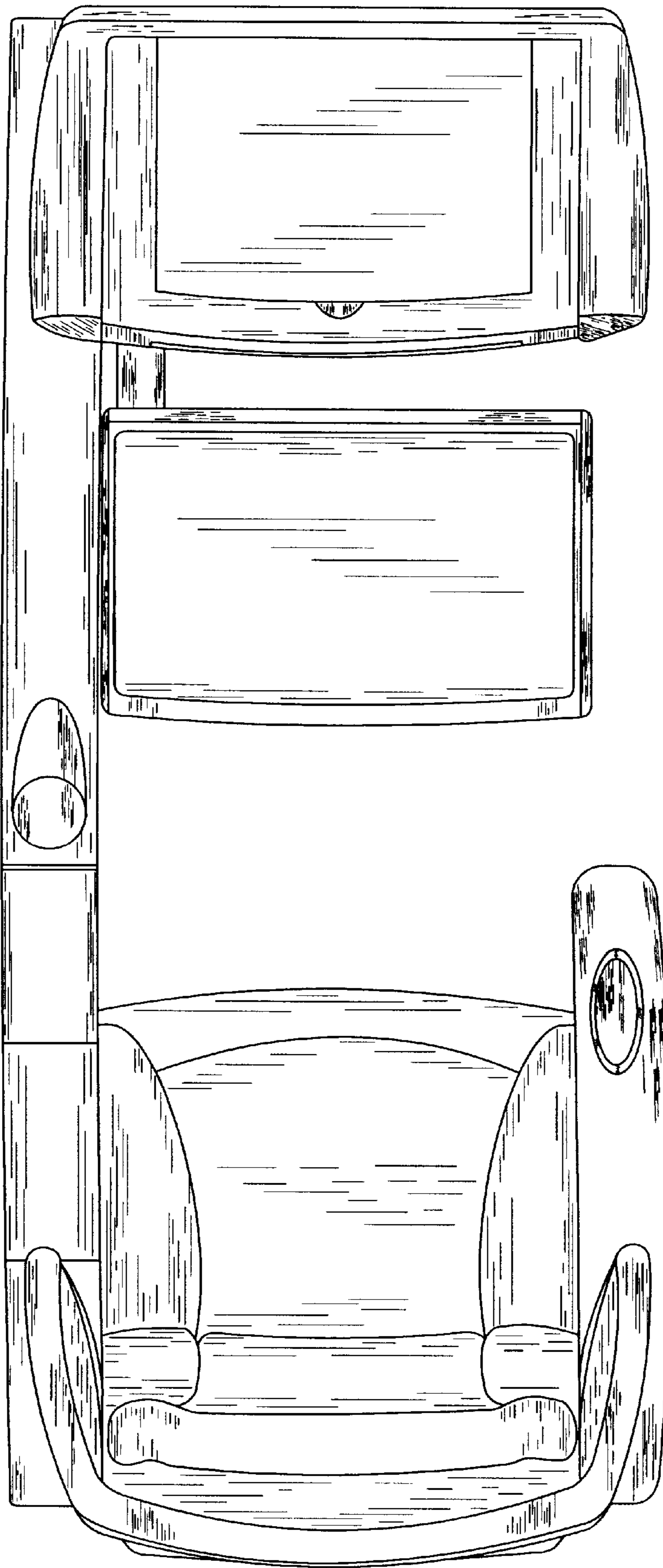

FIG. 4

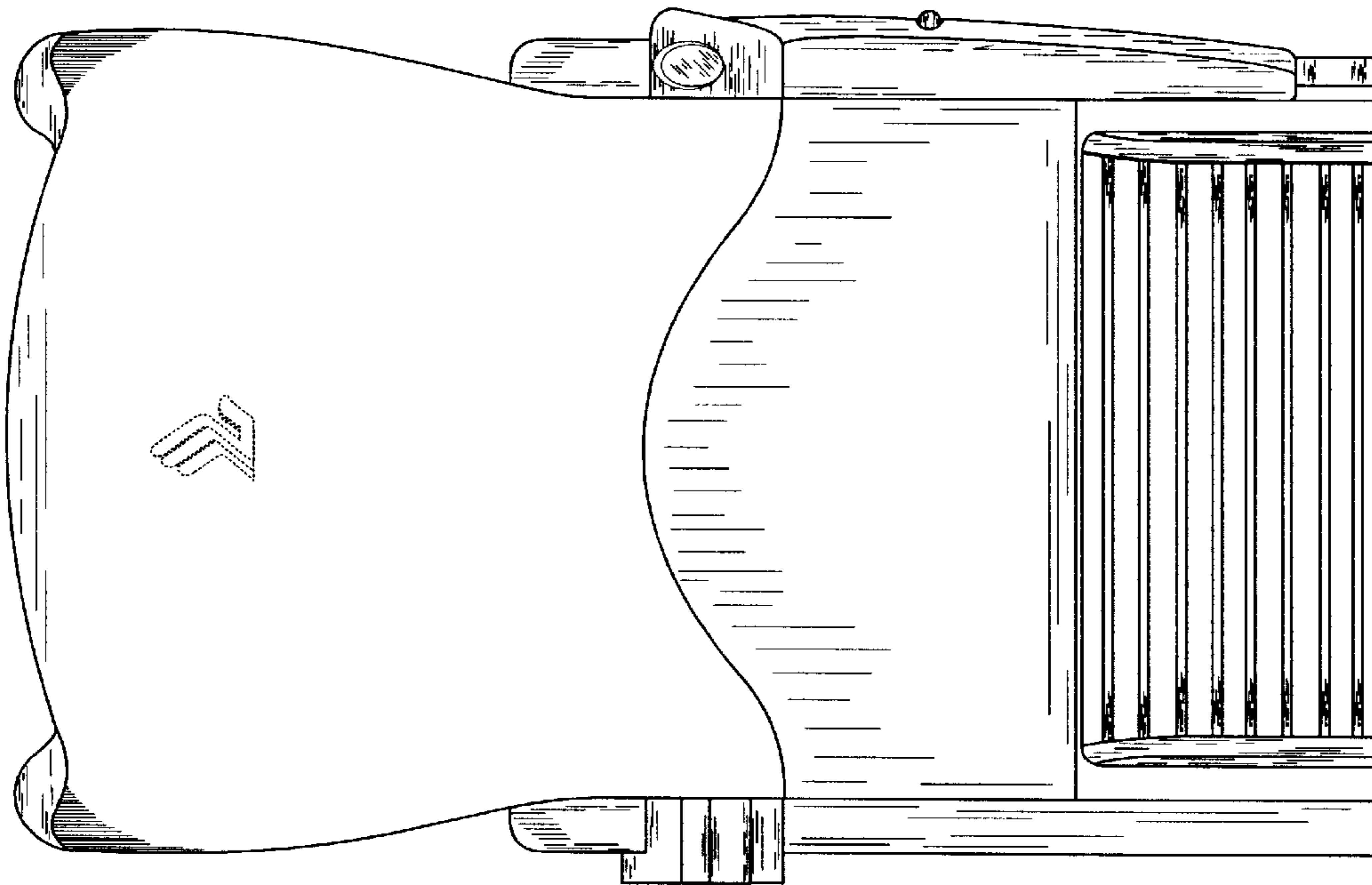

FIG. 5

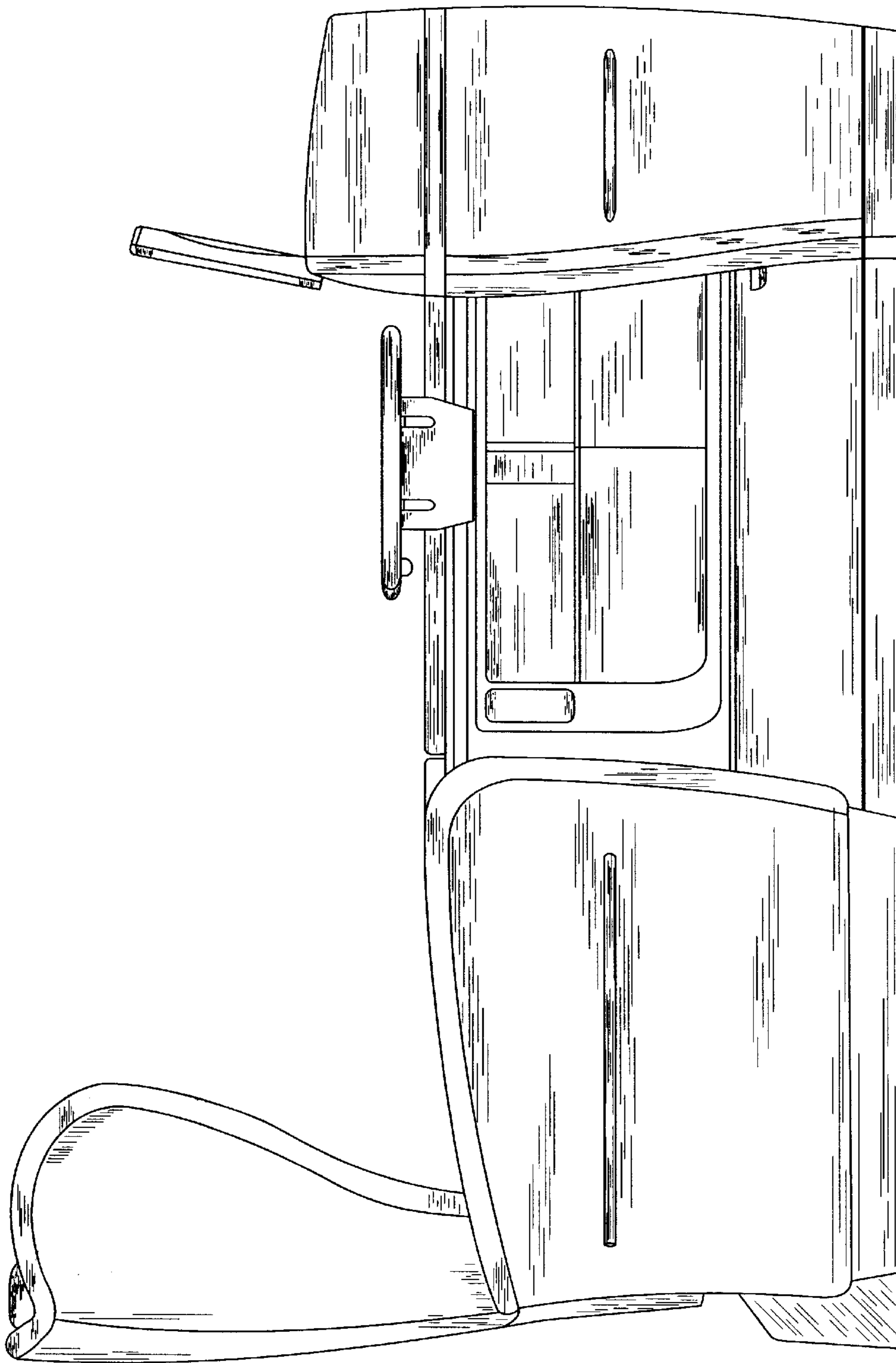

FIG. 6

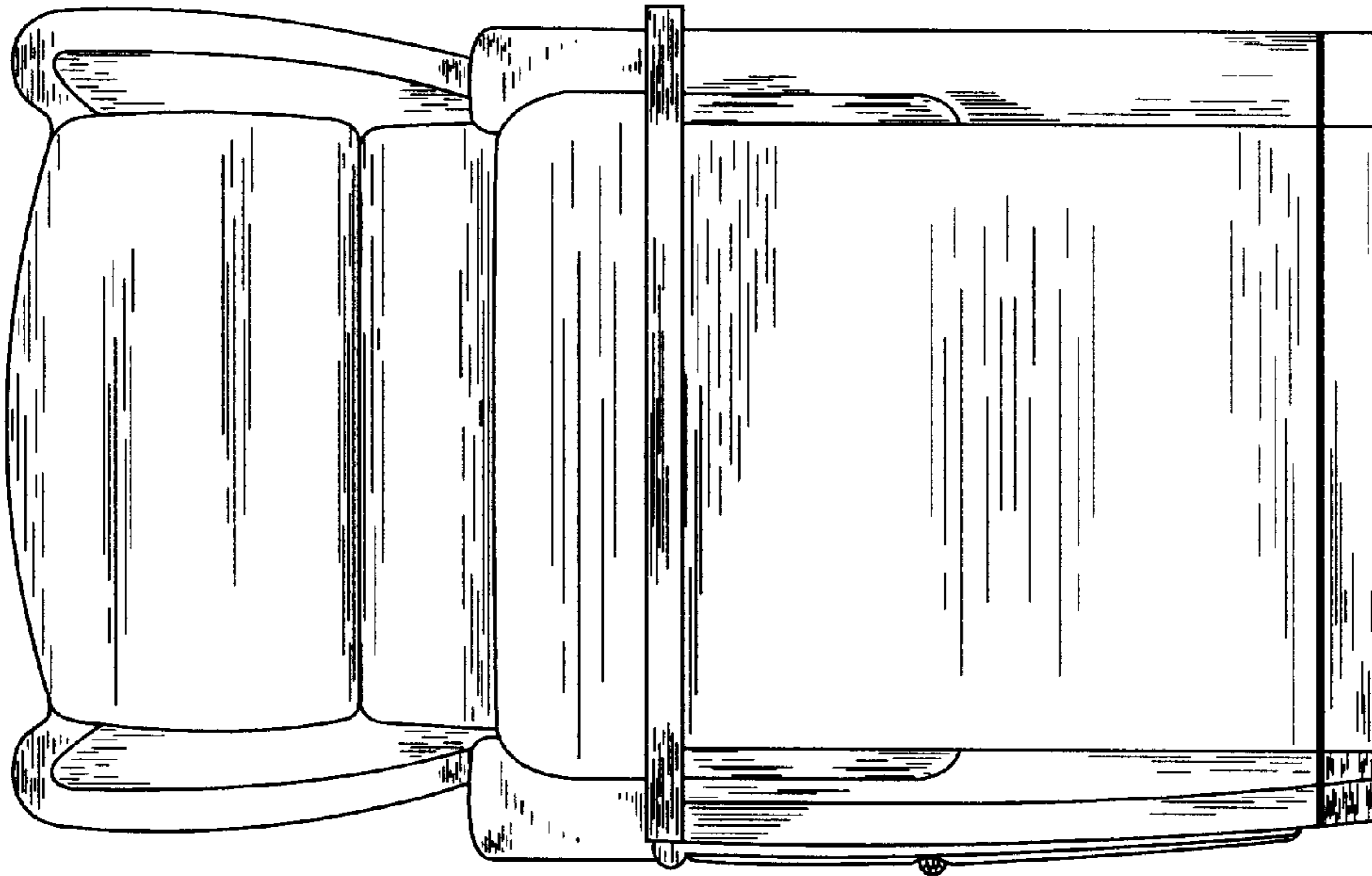

FIG. 7

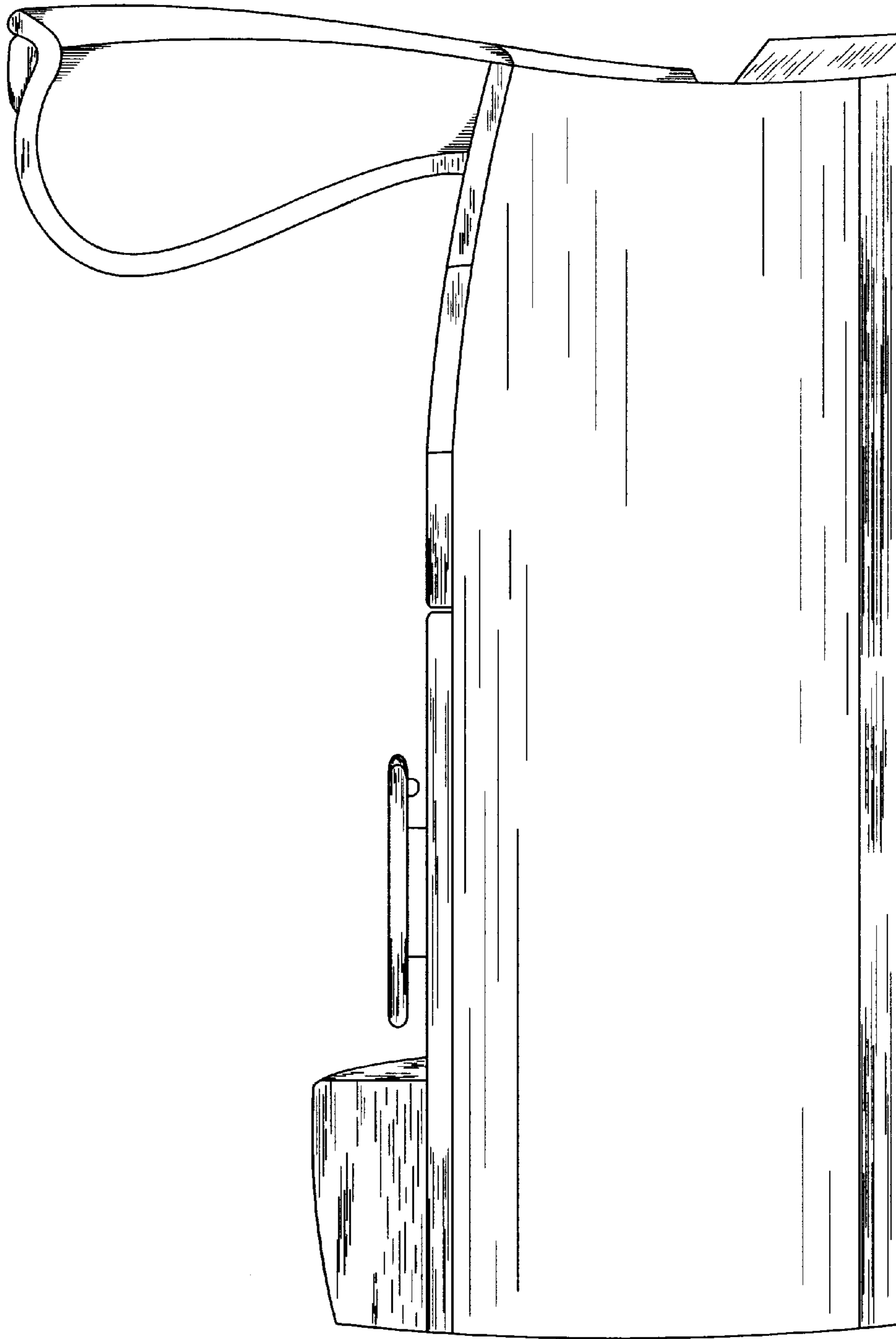

FIG. 8