



US00D439296S

(12) **United States Design Patent**  
**Besnard et al.**

(10) **Patent No.:** **US D439,296 S**

(45) **Date of Patent:** **\*\* Mar. 20, 2001**

(54) **GOLF CLUB HEAD COVER**

(75) Inventors: **Philippe Besnard**, Oceanside; **Marc P. Higgins**, Glendale, both of CA (US)

(73) Assignee: **Taylor Made Golf Company, Inc.**, Carlsbad, CA (US)

(\*\*) Term: **14 Years**

(21) Appl. No.: **29/121,515**

(22) Filed: **Apr. 6, 2000**

**Related U.S. Application Data**

(62) Division of application No. 29/108,038, filed on Jul. 19, 1999.

(51) **LOC (7) Cl.** ..... **21-02**

(52) **U.S. Cl.** ..... **D21/754**

(58) **Field of Search** ..... D21/754; 150/160

(56) **References Cited**

**U.S. PATENT DOCUMENTS**

D. 198,093	*	4/1964	Bates	.....	D21/754
D. 202,199	*	9/1965	Bates	.....	D21/754
D. 202,200	*	9/1965	Bates	.....	D21/754
D. 332,292	*	1/1993	Bloxsom	.....	D21/754
2,014,589		9/1935	Saad	.....	150/1.5
3,023,795	*	3/1962	Denkert	.....	150/160
3,406,419		10/1968	Young	.....	15/104.94
3,638,284	*	2/1972	Baker	.....	150/160
3,965,955		6/1976	Price	.....	150/52 G
4,667,716		5/1987	Solheim et al.	.....	150/52 G
5,117,884		6/1992	Diener et al.	.....	150/160
5,501,328		3/1996	Keller et al.	.....	206/315.6
5,547,193		8/1996	Sander	.....	473/252
5,868,248		2/1999	Joh	.....	206/315.6

\* cited by examiner

*Primary Examiner*—Mitchell Siegel

(74) *Attorney, Agent, or Firm*—John L. Rogitz

(57) **CLAIM**

The ornamental design for a golf club head cover, as shown and described.

**DESCRIPTION**

FIG. 1 is a perspective view of an alternate golf club head cover, with sections shaded to indicate black and other sections shaded to indicate orange, it being understood that sections shaded orange preferably are copper in color;

FIG. 2 is a top plan view of the golf club head cover shown in FIG. 1;

FIG. 3 is a first side elevational view of the golf club head cover shown in FIG. 1;

FIG. 4 is a front elevational view of the golf club head cover shown in FIG. 1;

FIG. 5 is a second side elevational view of the golf club head cover shown in FIG. 1;

FIG. 6 is a heel view of the golf club head cover shown in FIG. 1;

FIG. 7 is a bottom view of the golf club head cover shown in FIG. 1;

FIG. 8 is a perspective view of an alternate golf club head cover, with sections shaded to indicate black and other sections shaded to indicate orange, it being understood that sections shaded orange preferably are copper in color, also showing lettering;

FIG. 9 is a top plan view of the golf club head cover shown in FIG. 8;

FIG. 10 is a first side elevational view of the golf club head cover shown in FIG. 8;

FIG. 11 is a front elevational view of the golf club head cover shown in FIG. 8;

FIG. 12 is a second side elevational view of the golf club head cover shown in FIG. 8;

FIG. 13 is a heel view of the golf club head cover shown in FIG. 8;

FIG. 14 is a bottom view of the golf club head cover shown in FIG. 8;

FIG. 15 is a perspective view of an alternate golf club head cover, with sections shaded to indicate black and other sections shaded to indicate orange, it being understood that sections shaded orange preferably are copper in color;

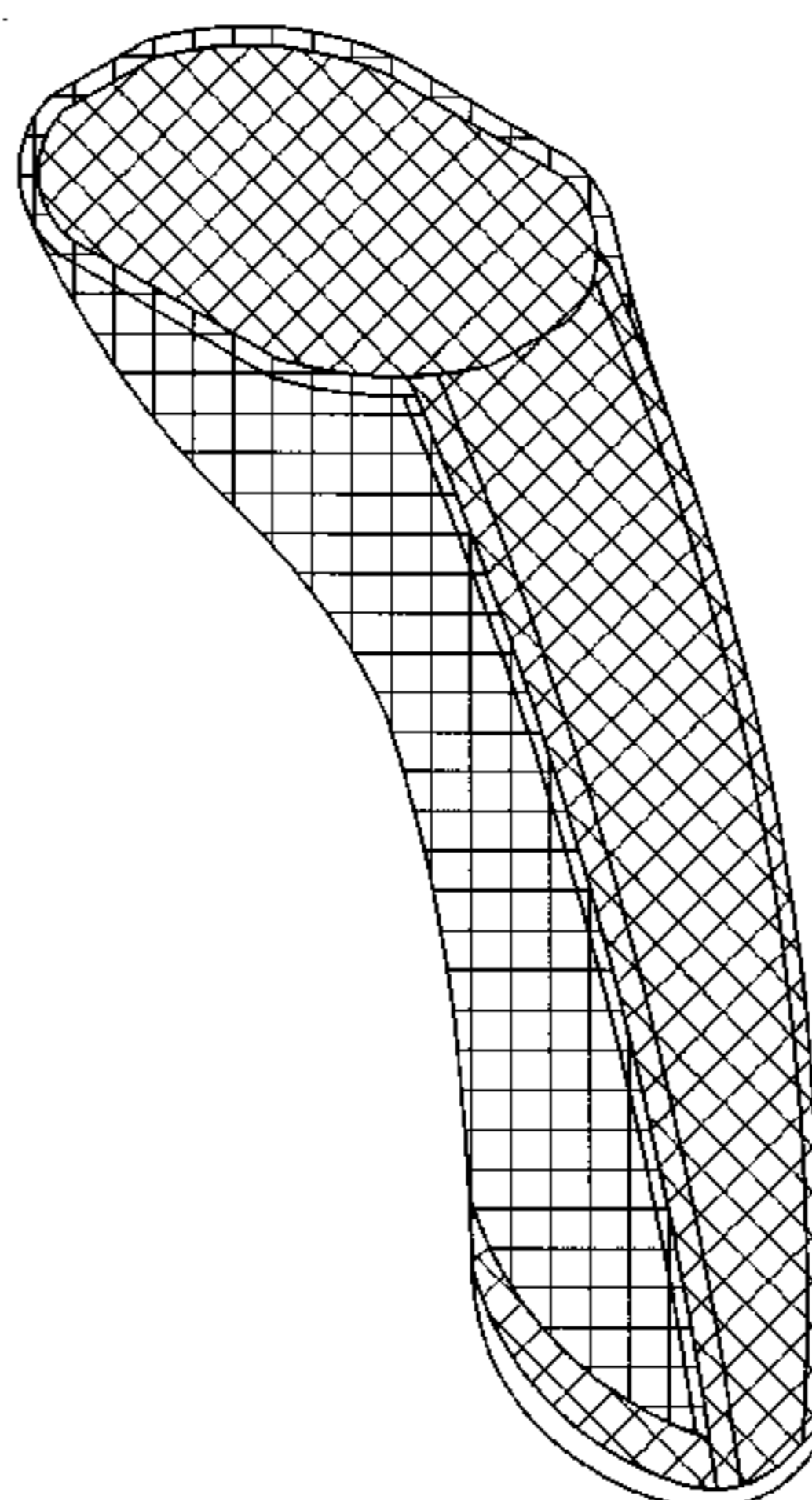

FIG. 16 is a top plan view of the golf club head cover shown in FIG. 15;

FIG. 17 is a first side elevational view of the golf club head cover shown in FIG. 15;

FIG. 18 is a front elevational view of the golf club head cover shown in FIG. 15;

FIG. 19 is a second side elevational view of the golf club head cover shown in FIG. 15;

FIG. 20 is a heel view of the golf club head cover shown in FIG. 15;

FIG. 21 is a bottom view of the golf club head cover shown in FIG. 15;

FIG. 22 is a perspective view of an alternate golf club head cover, with sections shaded to indicate black and other sections shaded to indicate orange, it being understood that sections shaded orange preferably are copper in color, also showing lettering;

FIG. 23 is a top plan view of the golf club head cover shown in FIG. 22;

FIG. 24 is a first side elevational view of the golf club head cover shown in FIG. 22;

FIG. 25 is a front elevational view of the golf club head cover shown in FIG. 22;

FIG. 26 is a second side elevational view of the golf club head cover shown in FIG. 22;

FIG. 27 is a heel view of the golf club head cover shown in FIG. 22;

FIG. 28 is a bottom view of the golf club head cover shown in FIG. 22;

FIG. 29 is a perspective view of an alternate golf club head cover, with sections shaded to indicate black and other sections shaded to indicate orange, it being understood that sections shaded orange preferably are copper in color;

FIG. 30 is a top plan view of the golf club head cover shown in FIG. 29;

FIG. 31 is a first side elevational view of the golf club head cover shown in FIG. 29;

FIG. 32 is a front elevational view of the golf club head cover shown in FIG. 29;

FIG. 33 is a second side elevational view of the golf club head cover shown in FIG. 29;

FIG. 34 is a heel view of the golf club head cover shown in FIG. 29;

FIG. 35 is a bottom view of the golf club head cover shown in FIG. 29;

FIG. 36 is a perspective view of an alternate golf club head cover, with sections shaded to indicate black and other sections shaded to indicate orange, it being understood that sections shaded orange preferably are copper in color, also showing lettering;

FIG. 37 is a top plan view of the golf club head cover shown in FIG. 36;

FIG. 38 is a first side elevational view of the golf club head cover shown in FIG. 36;

FIG. 39 is a front elevational view of the golf club head cover shown in FIG. 36;

FIG. 40 is a second side elevational view of the golf club head cover shown in FIG. 36;

FIG. 41 is a heel view of the golf club head cover shown in FIG. 36; and,

FIG. 42 is a bottom view of the golf club head cover shown in FIG. 36.

**1 Claim, 18 Drawing Sheets**

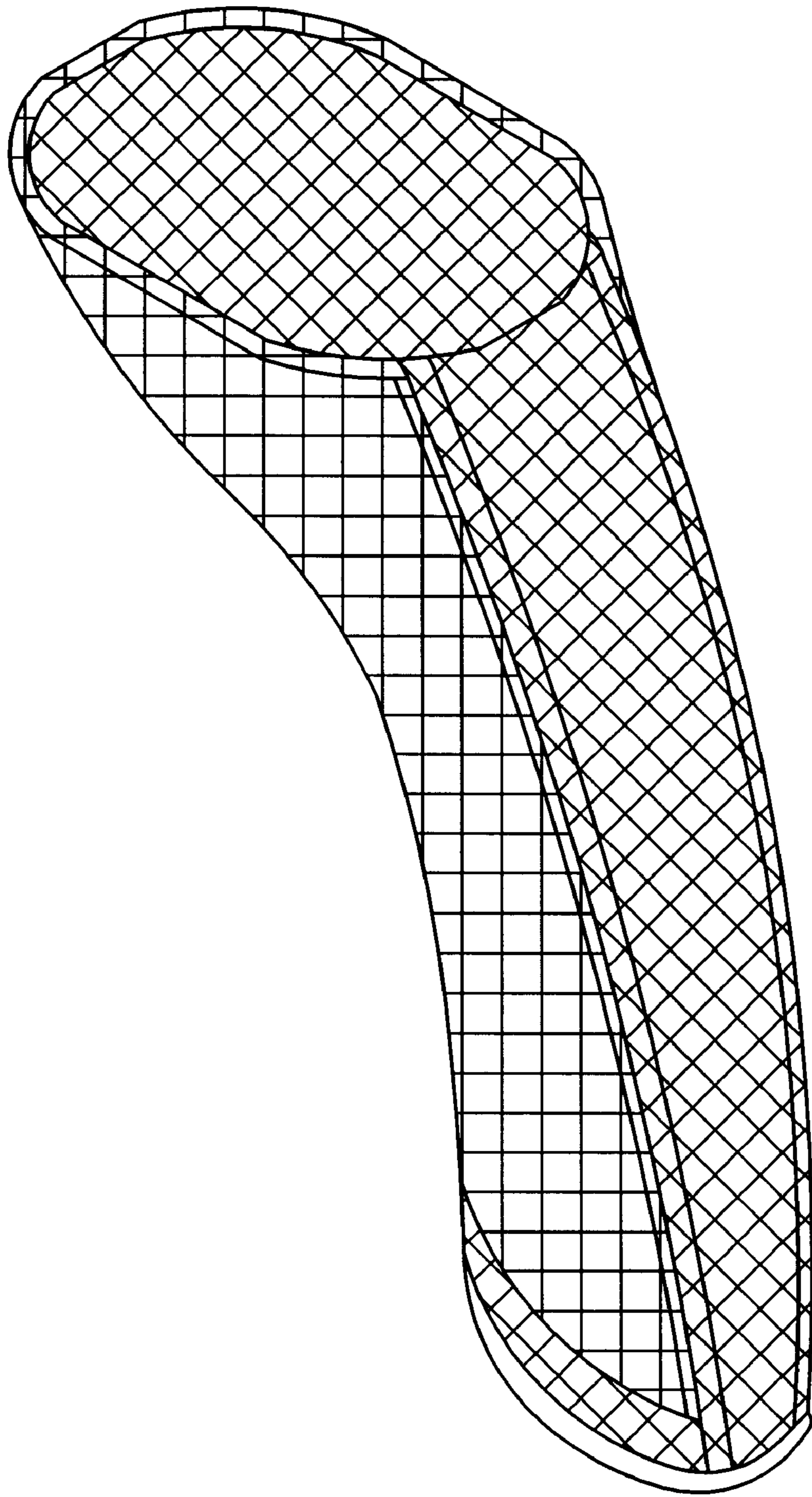

FIG. 1

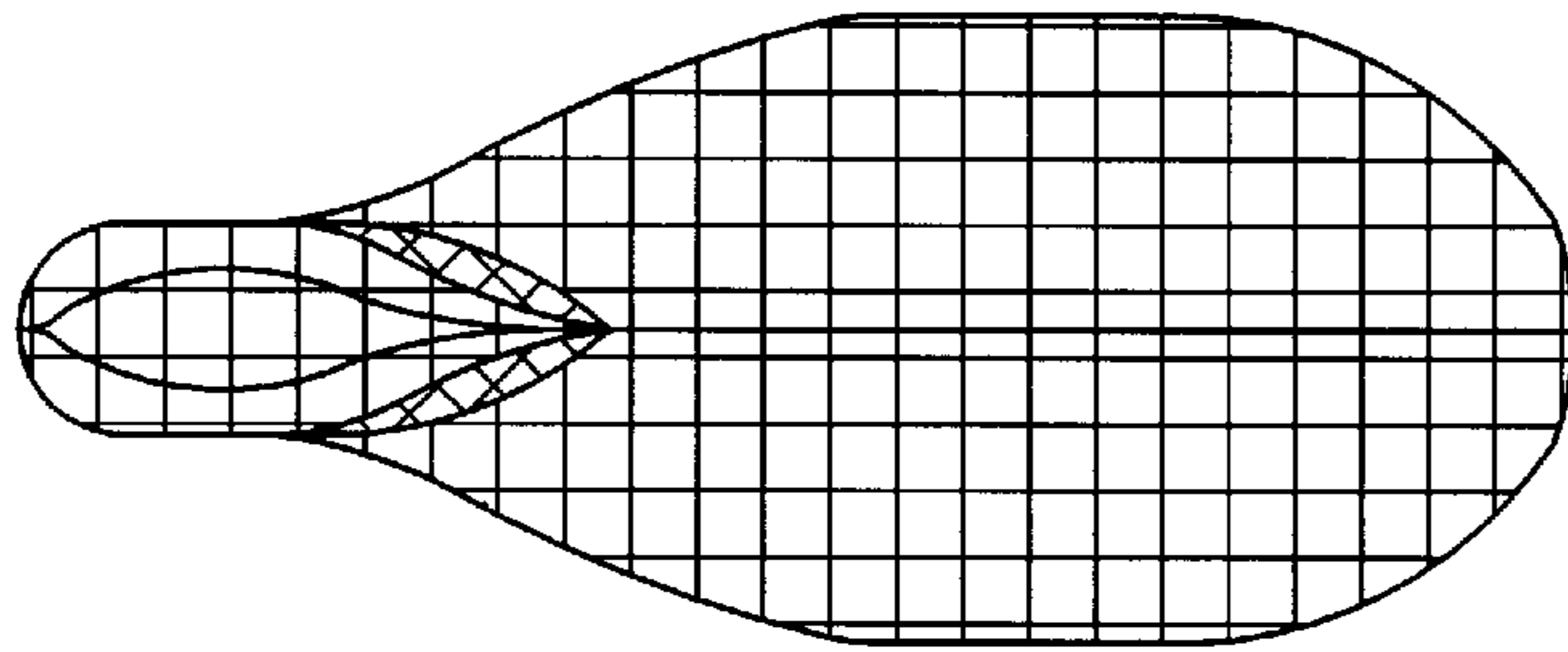

FIG. 2

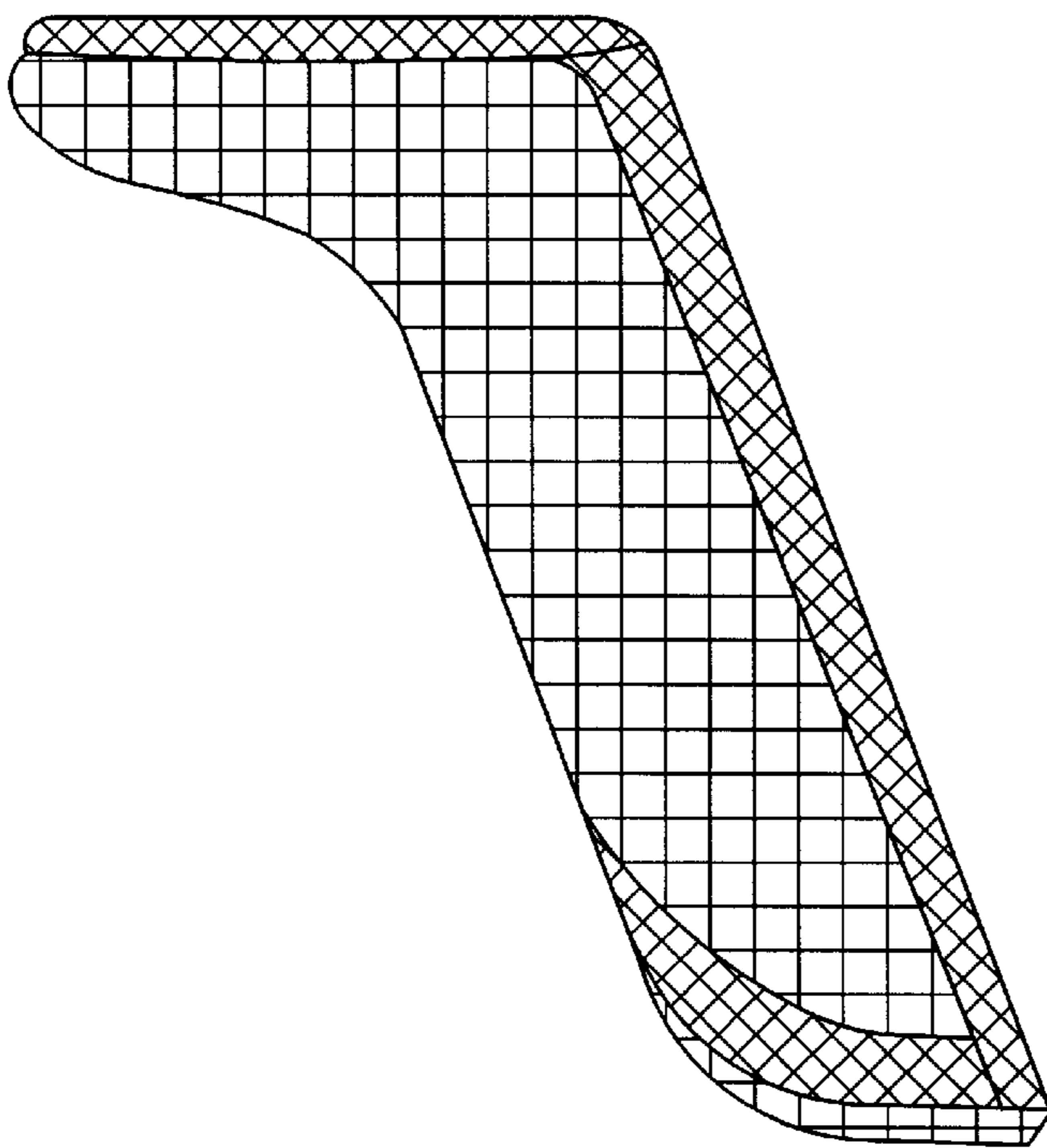

FIG. 3

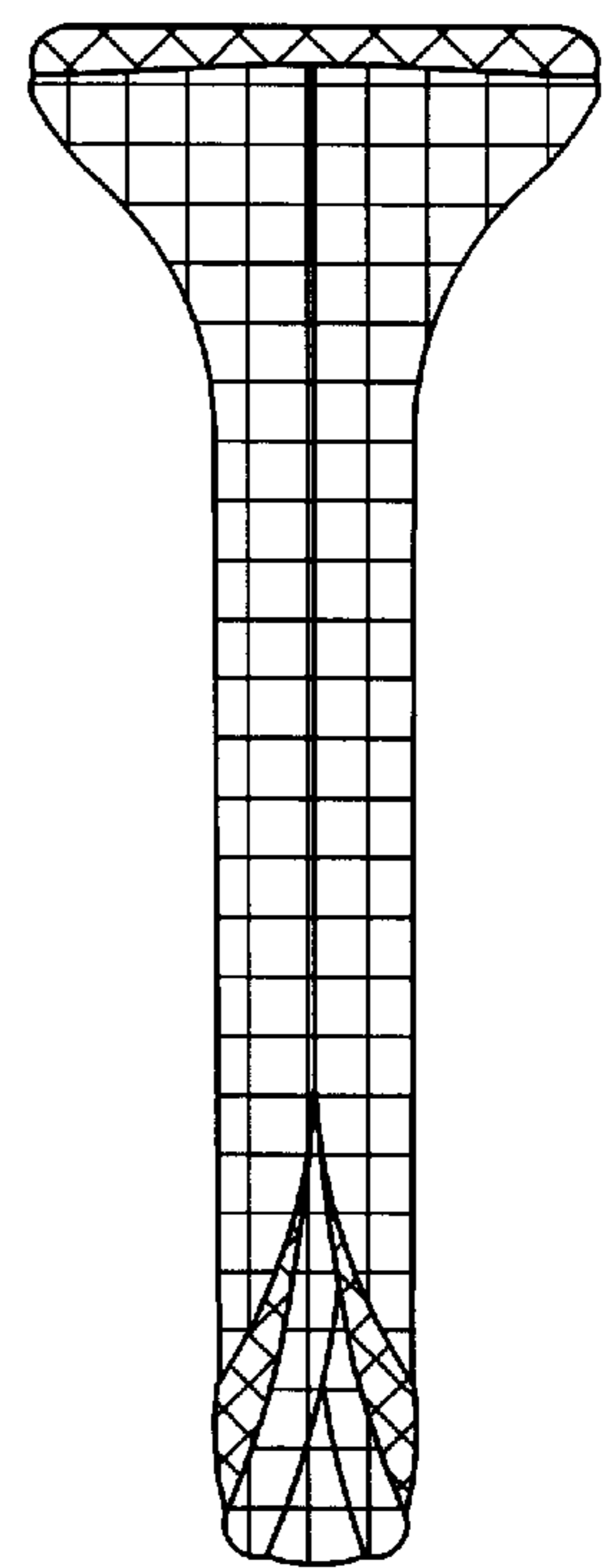

FIG. 4

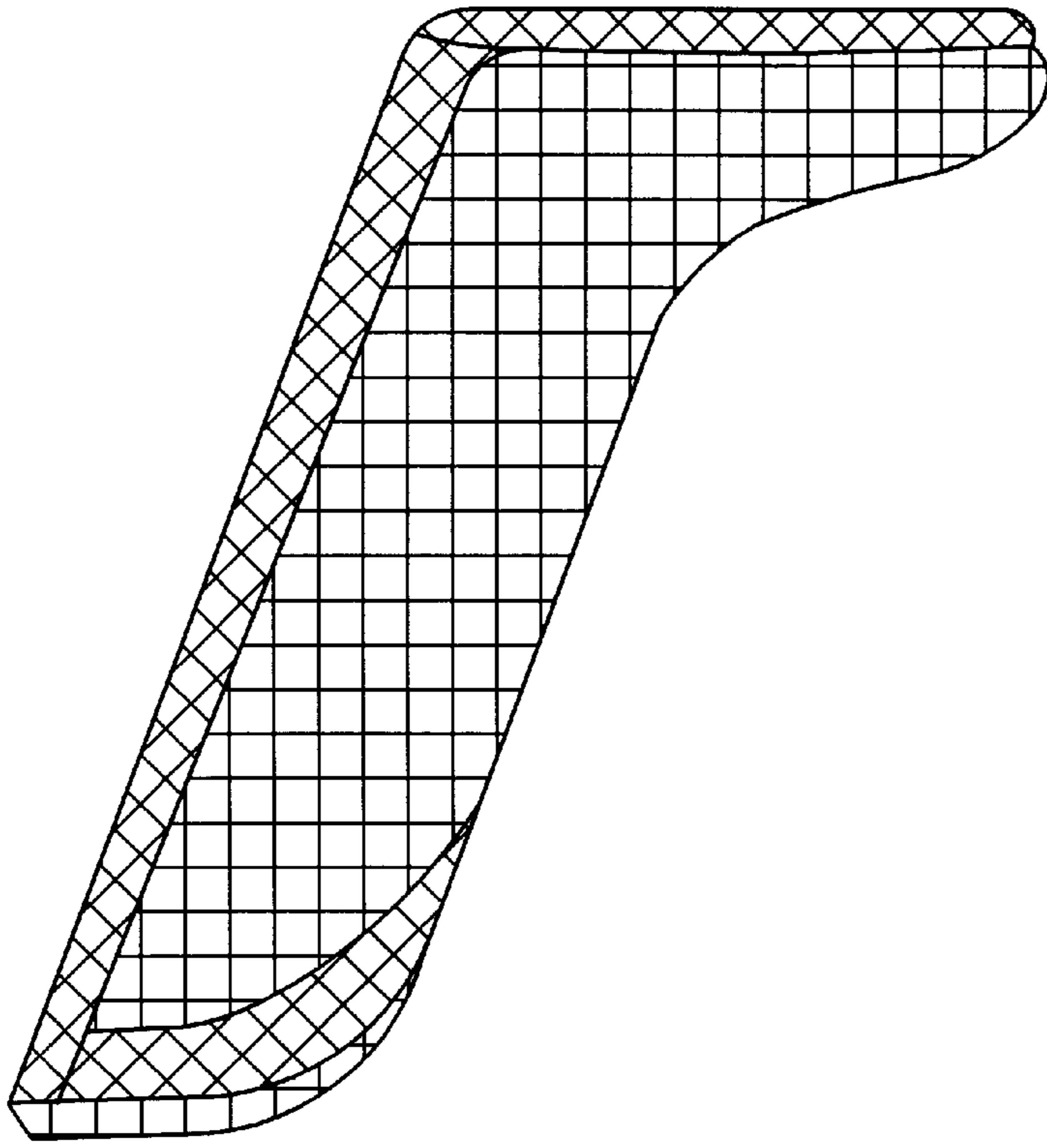

FIG. 5

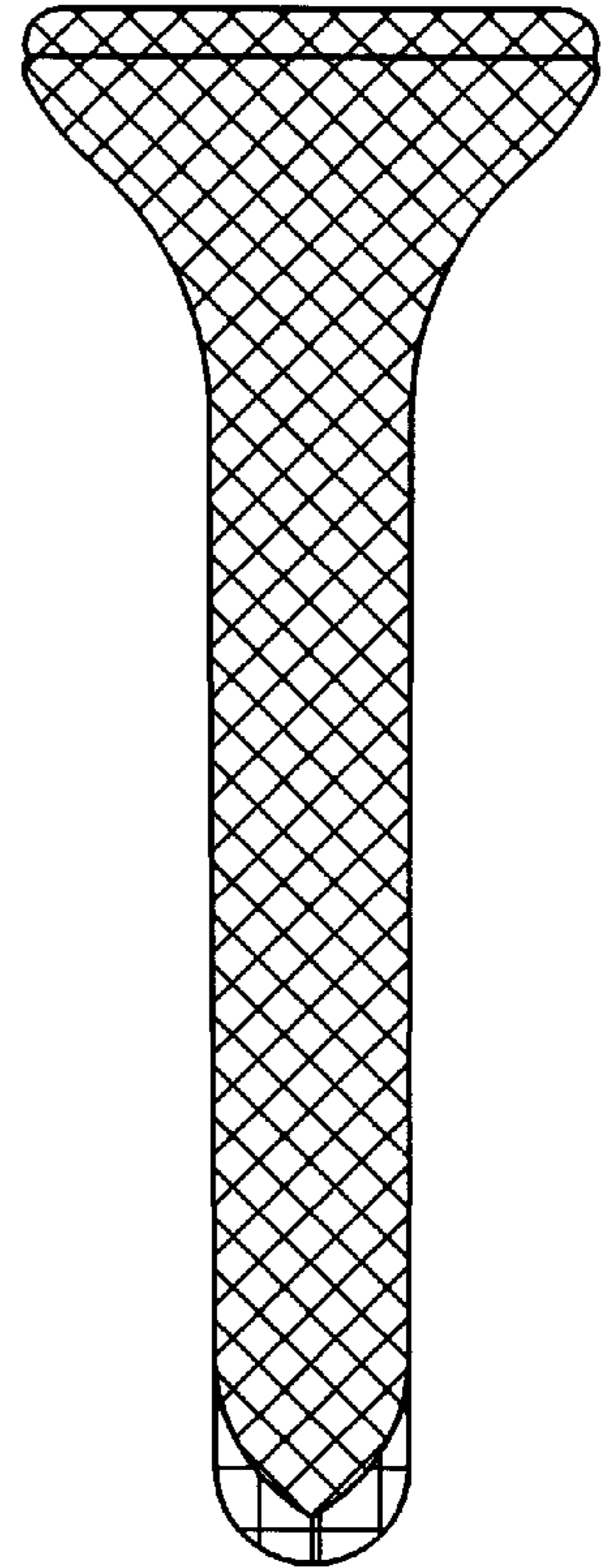

FIG. 6

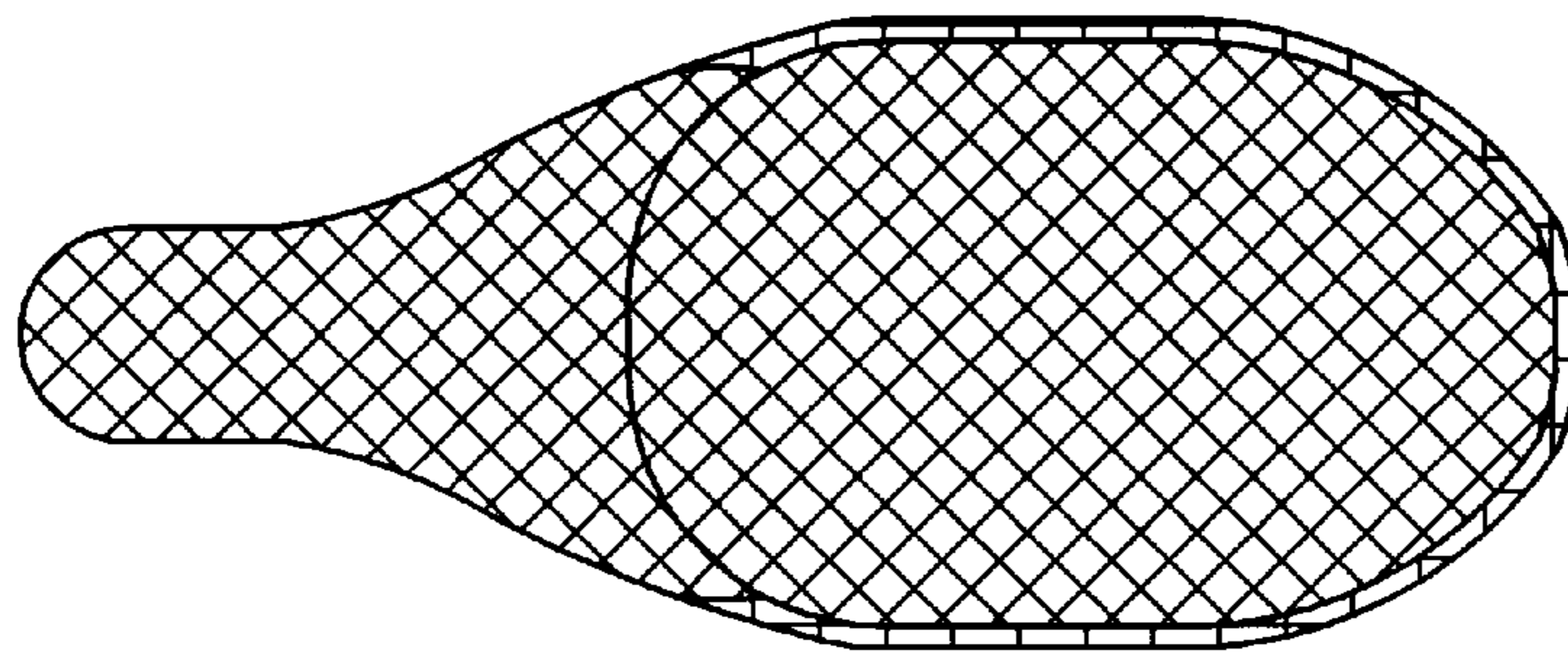

FIG. 7

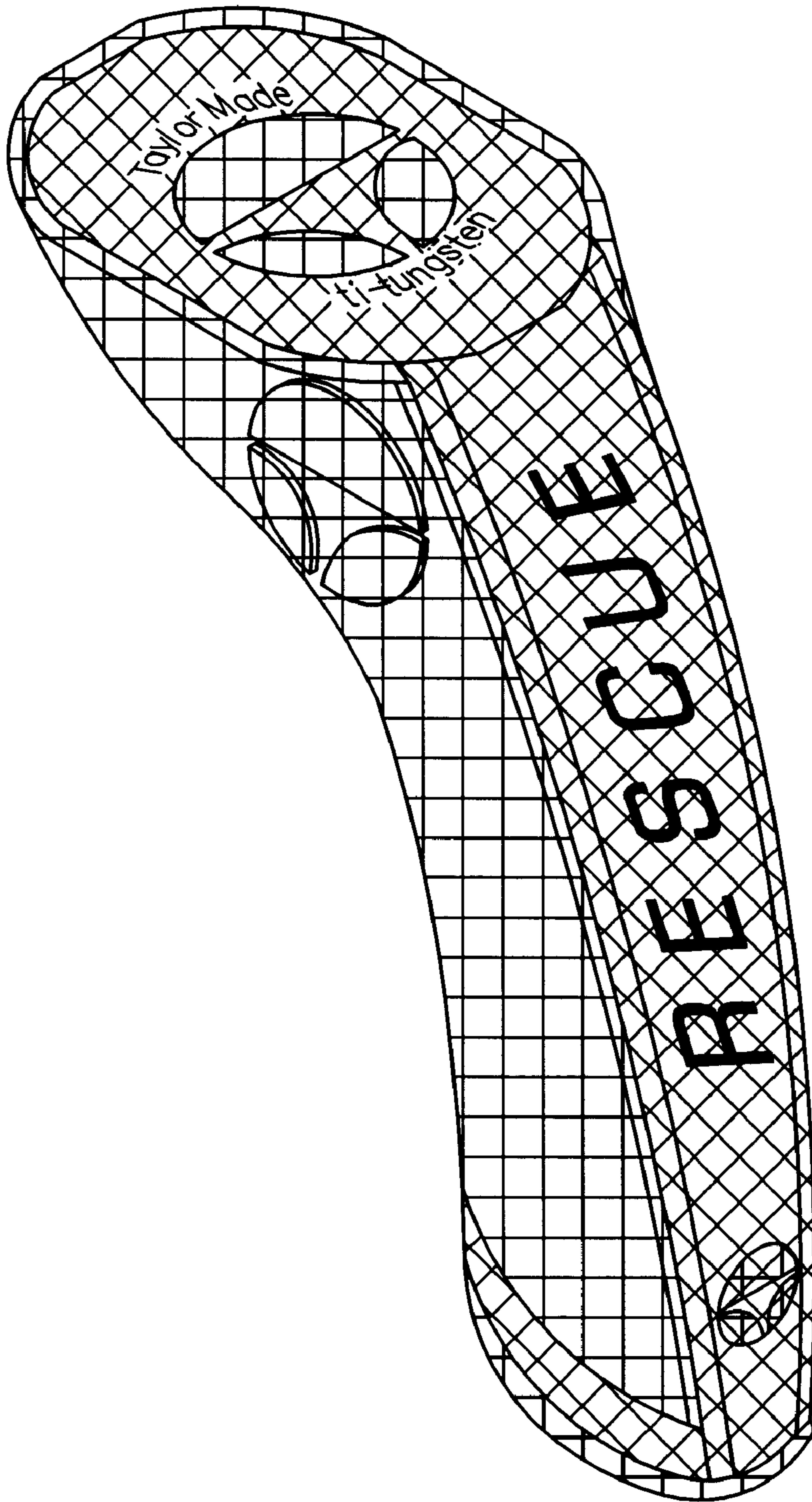

FIG. 8

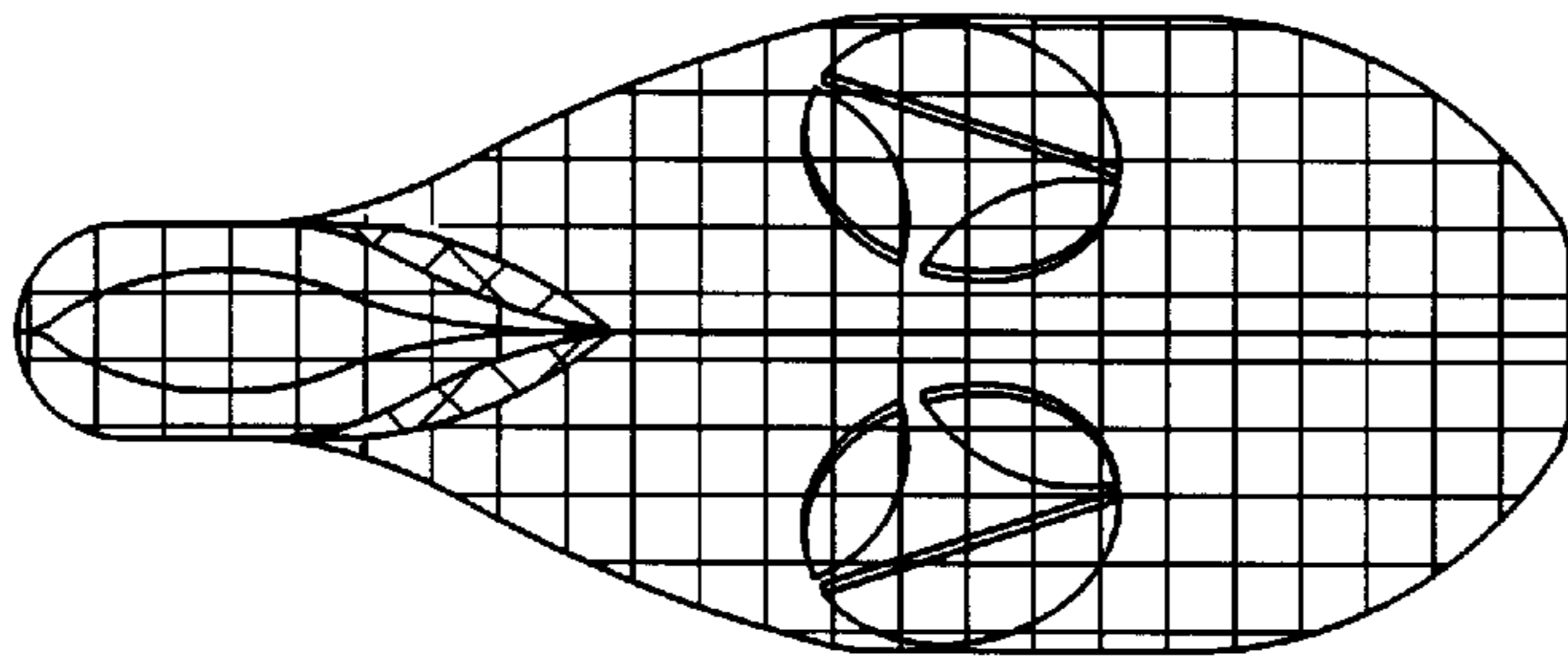

FIG. 9

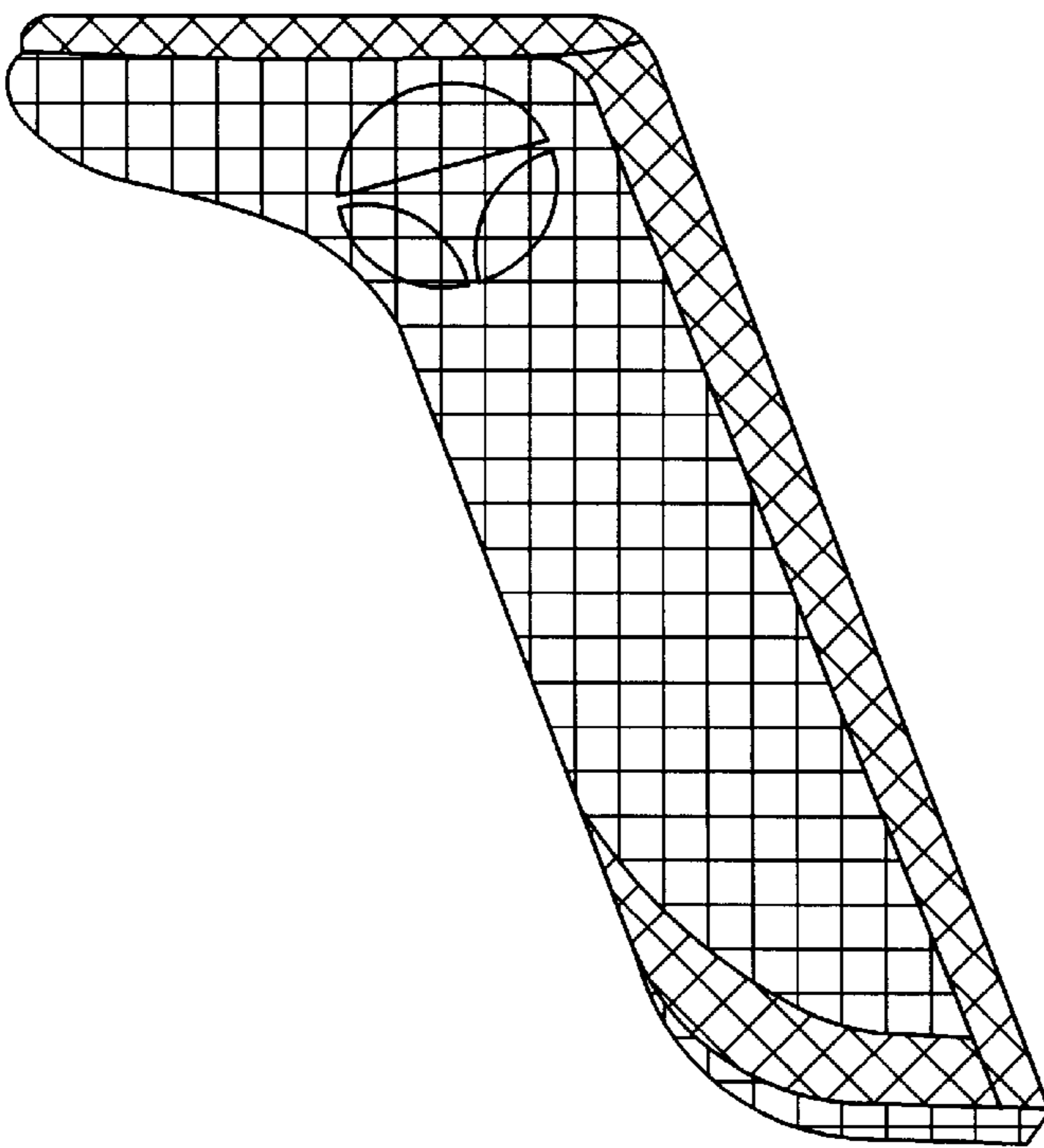

FIG. 10

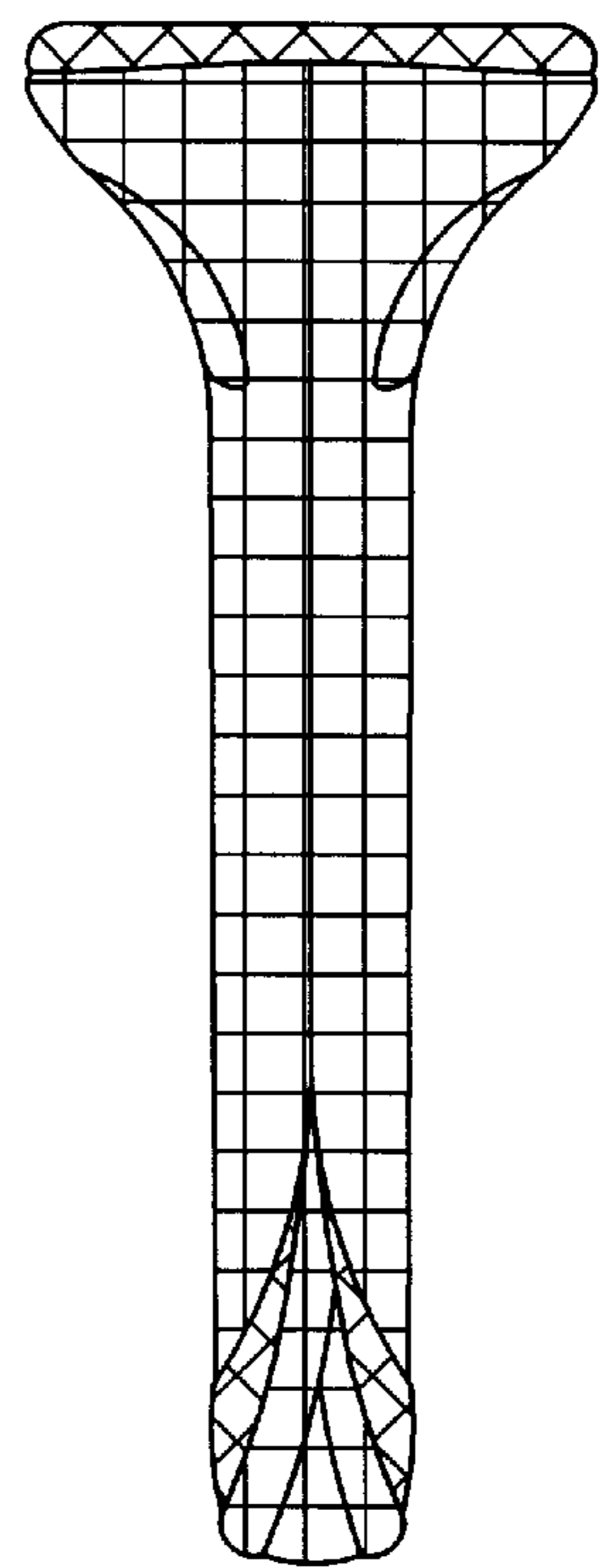

FIG. 11

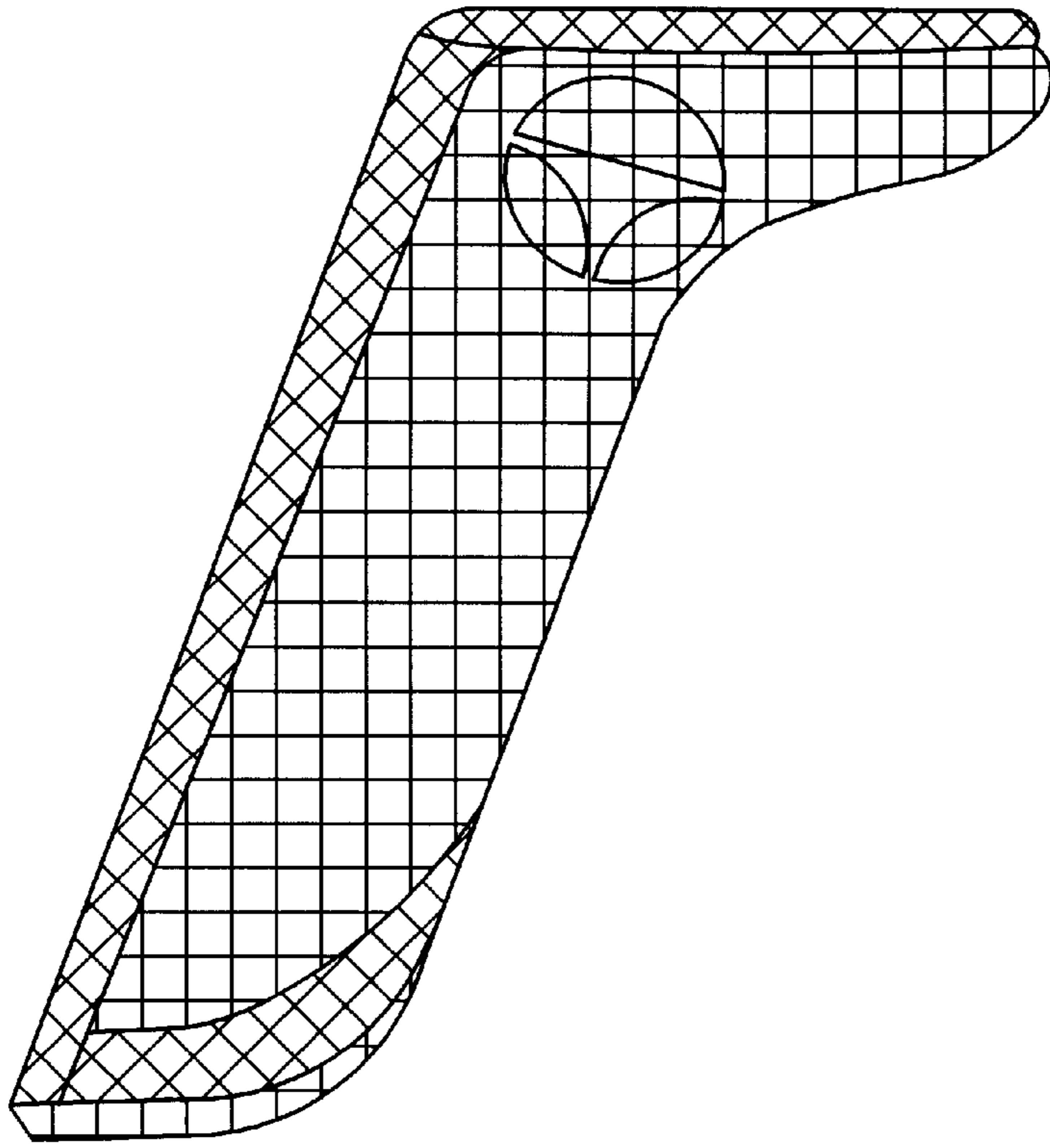

FIG. 12

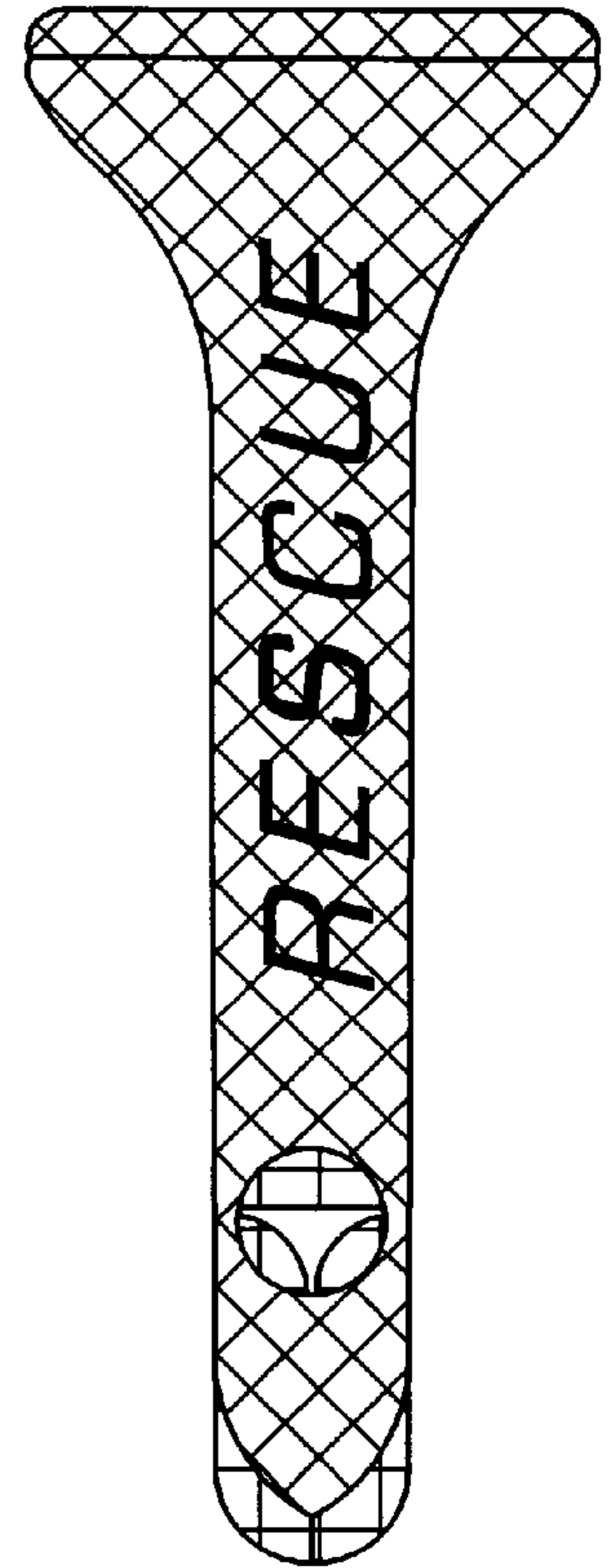

FIG. 13

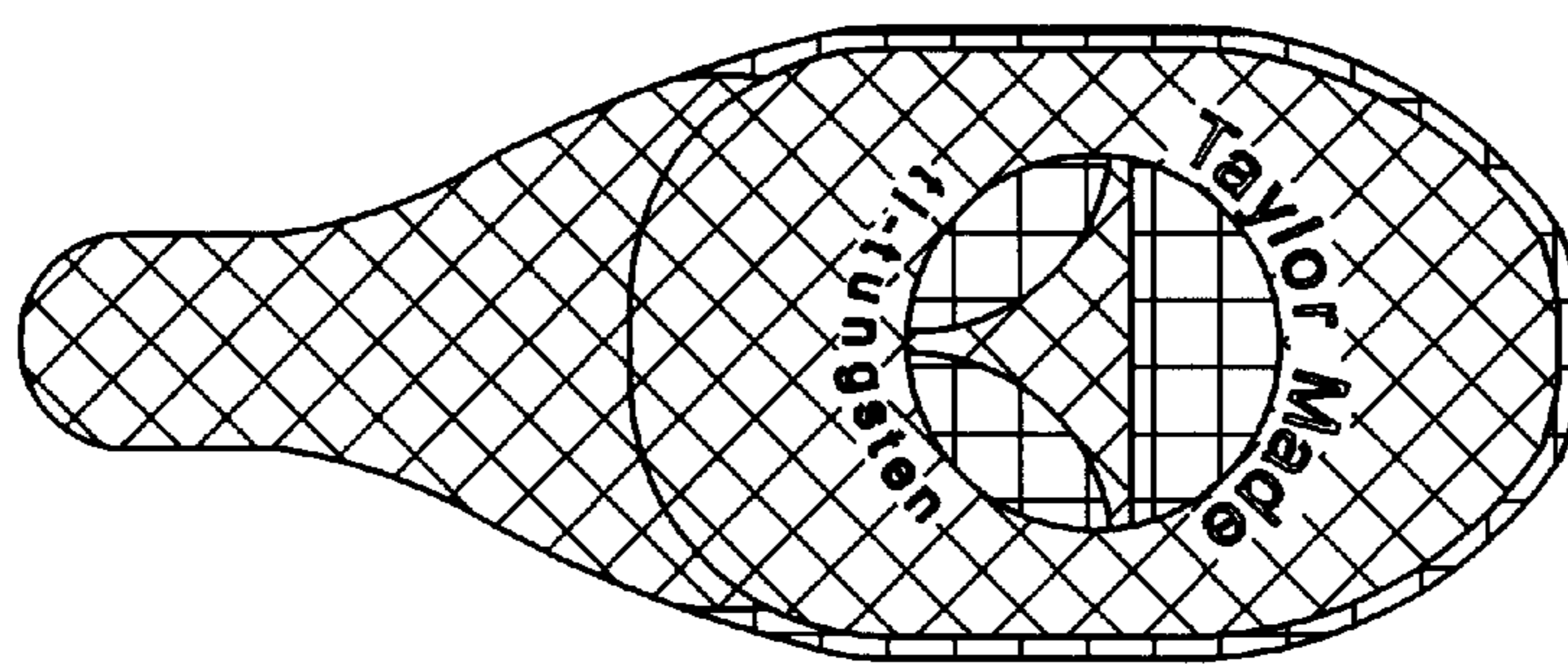

FIG. 14



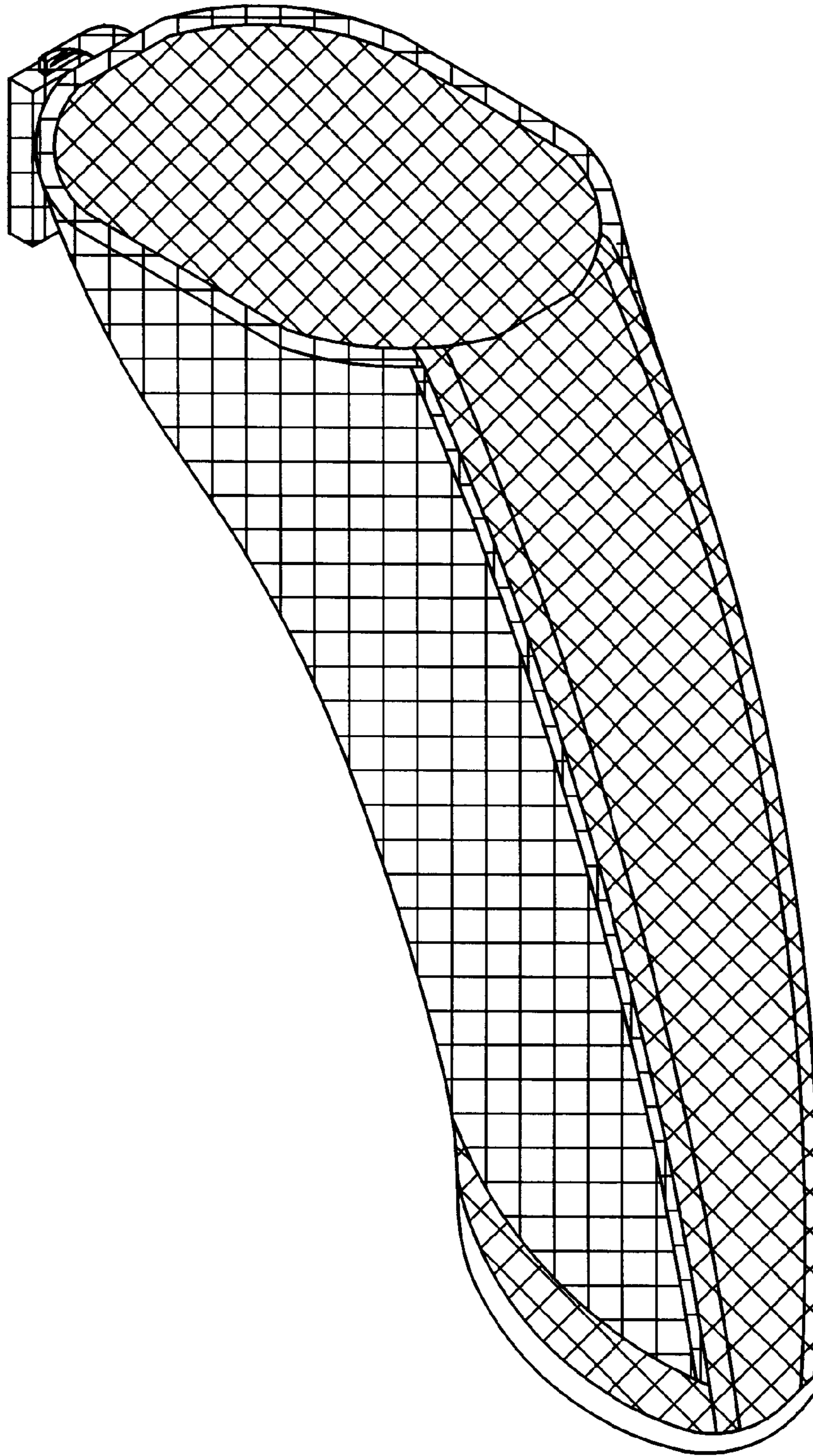

FIG. 15

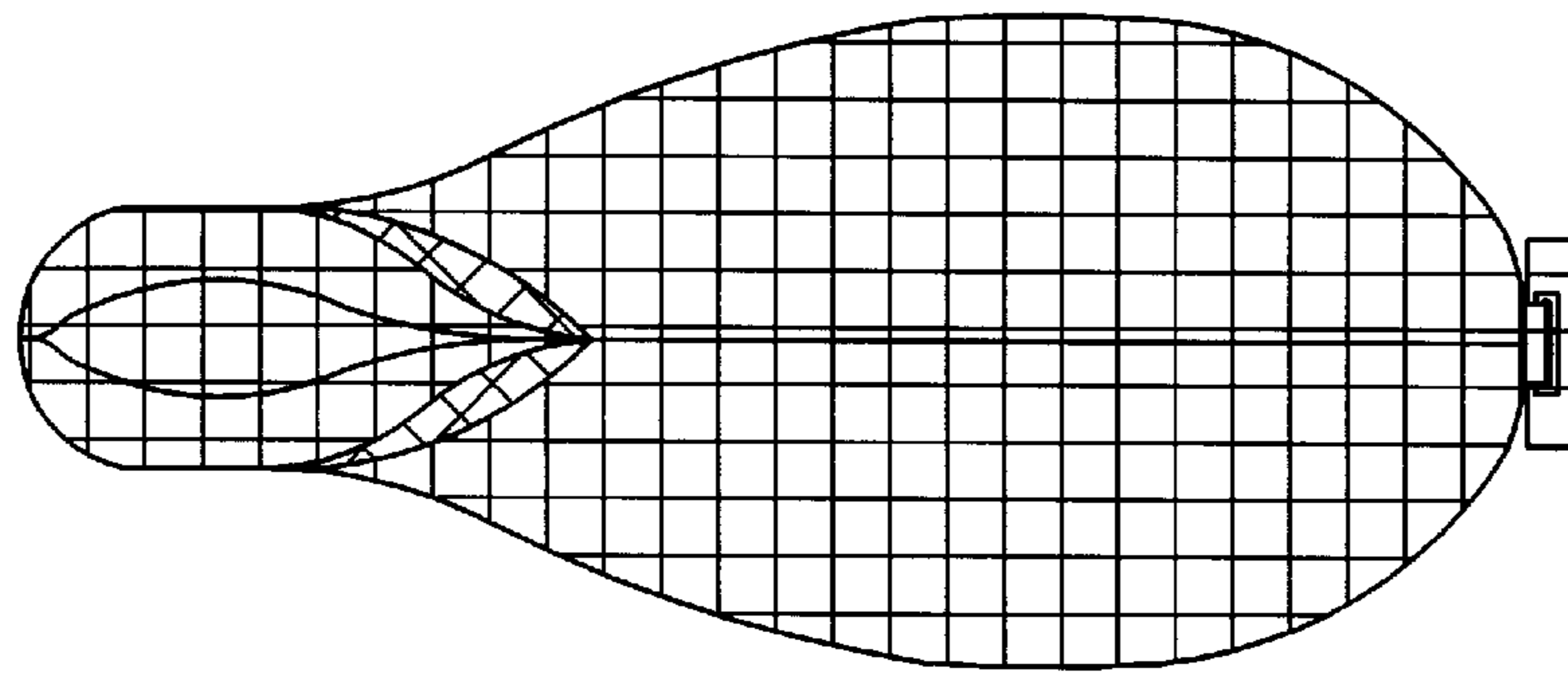

FIG. 16

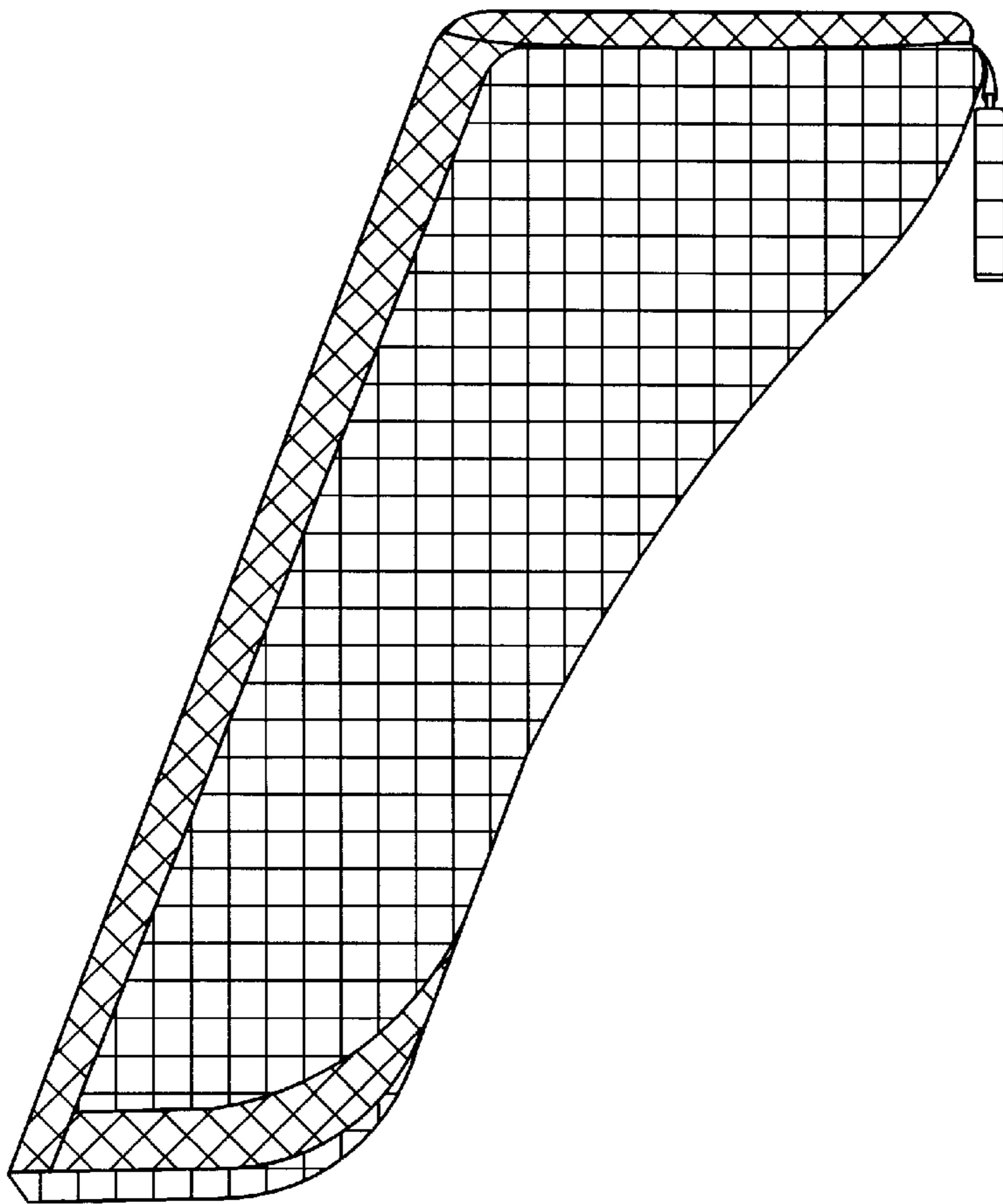

FIG. 17

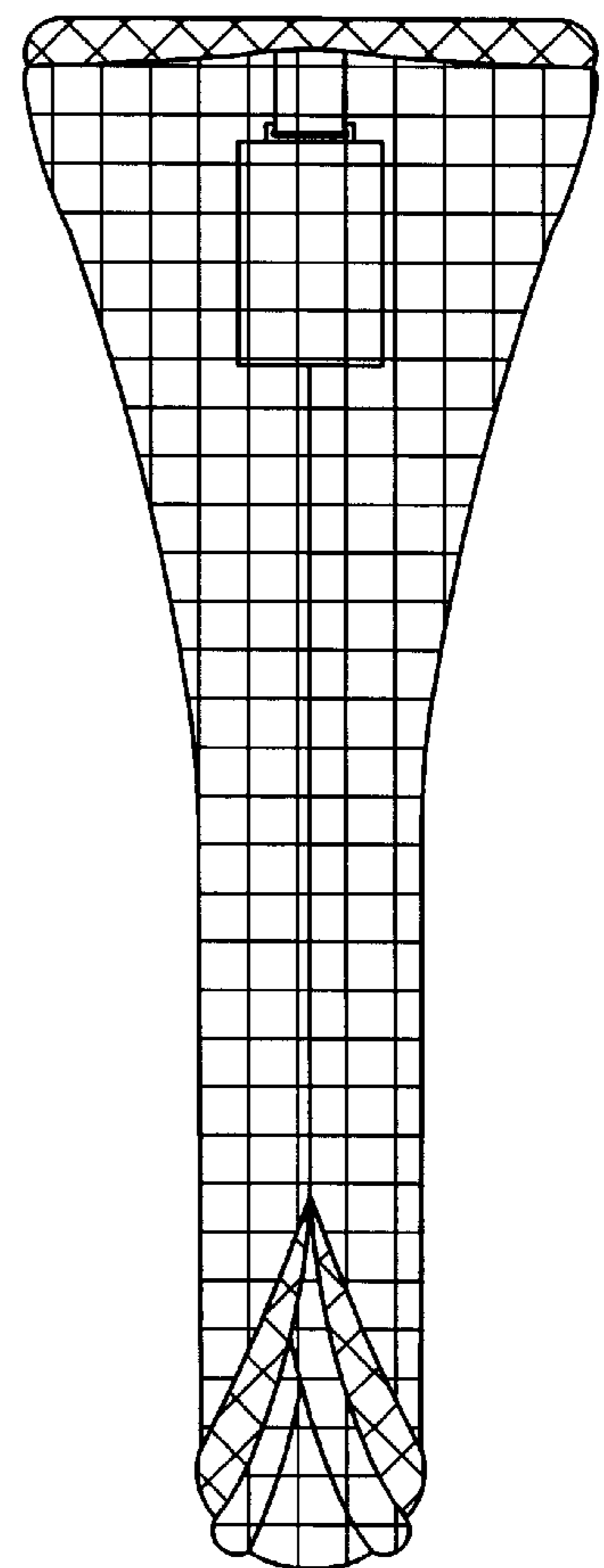

FIG. 18

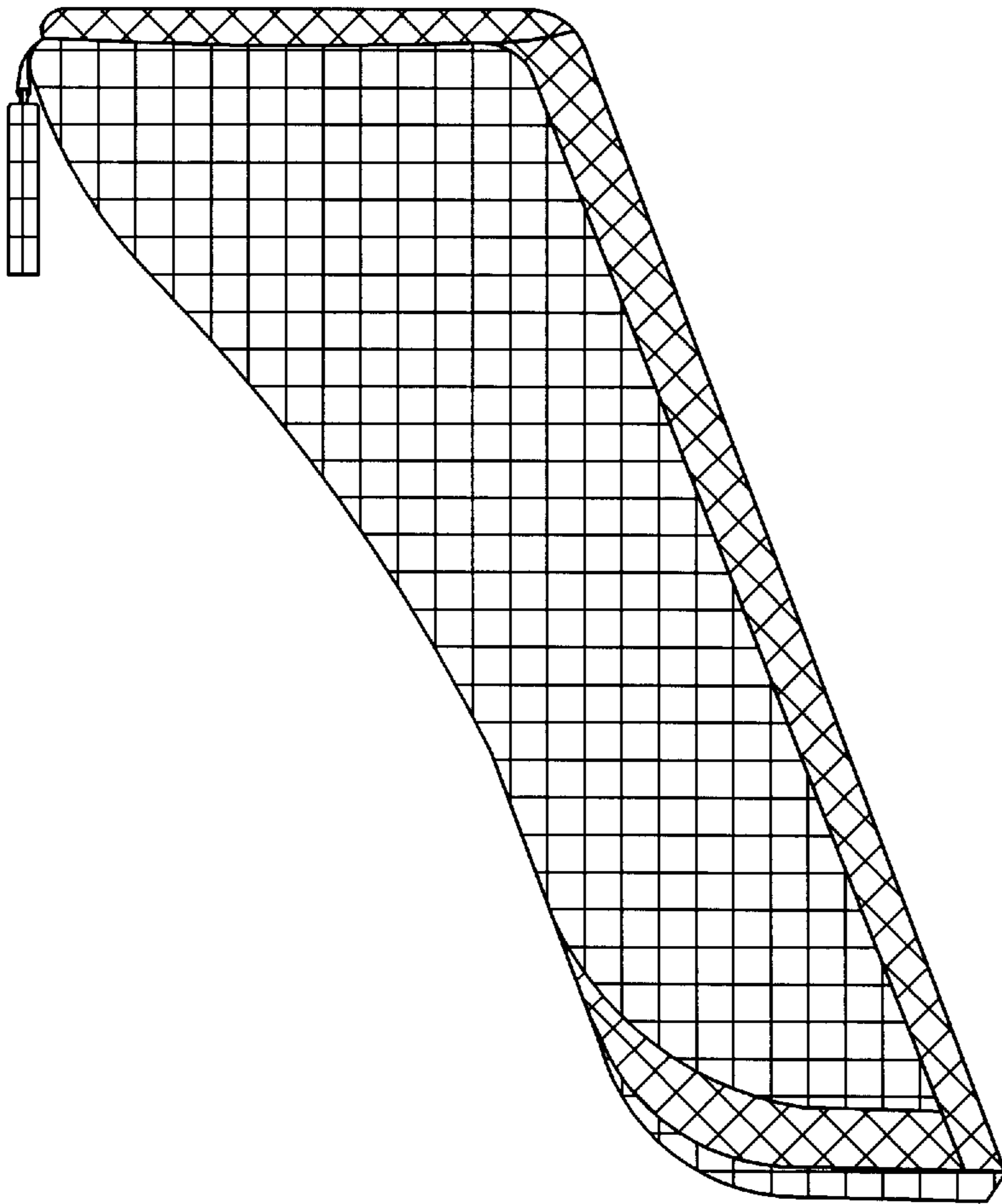

FIG. 19

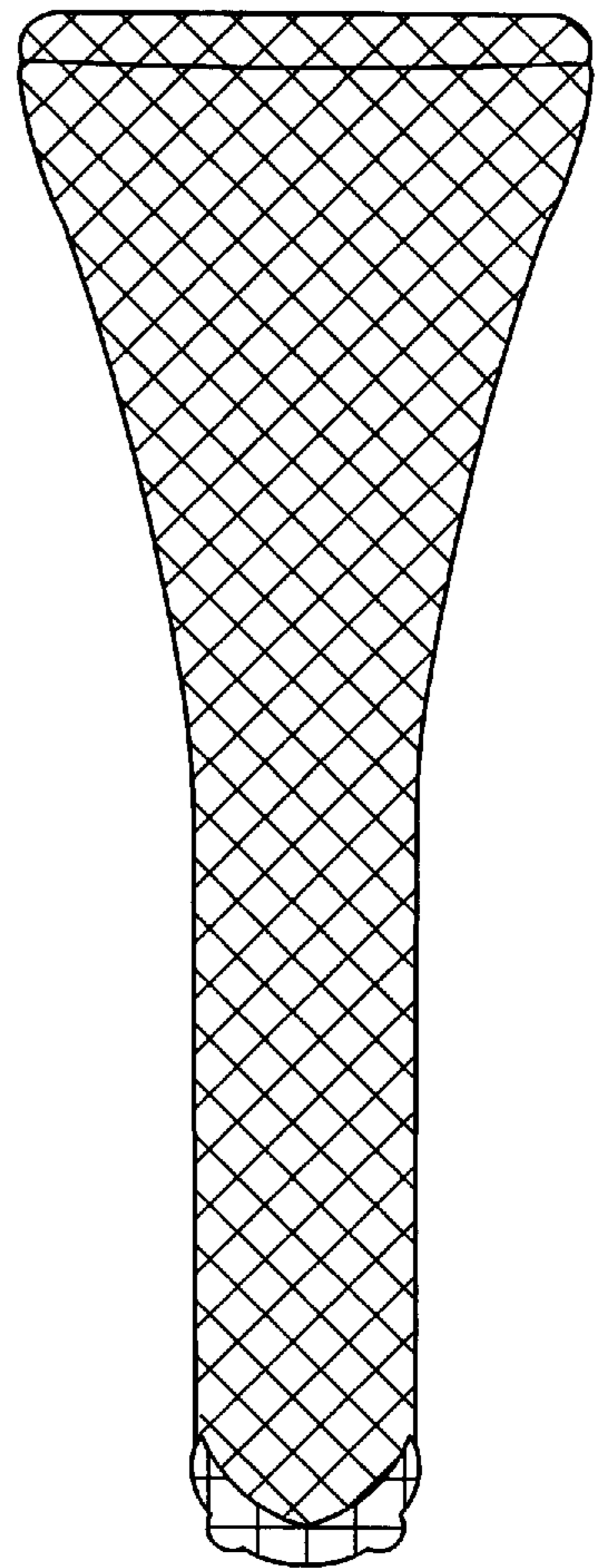

FIG. 20

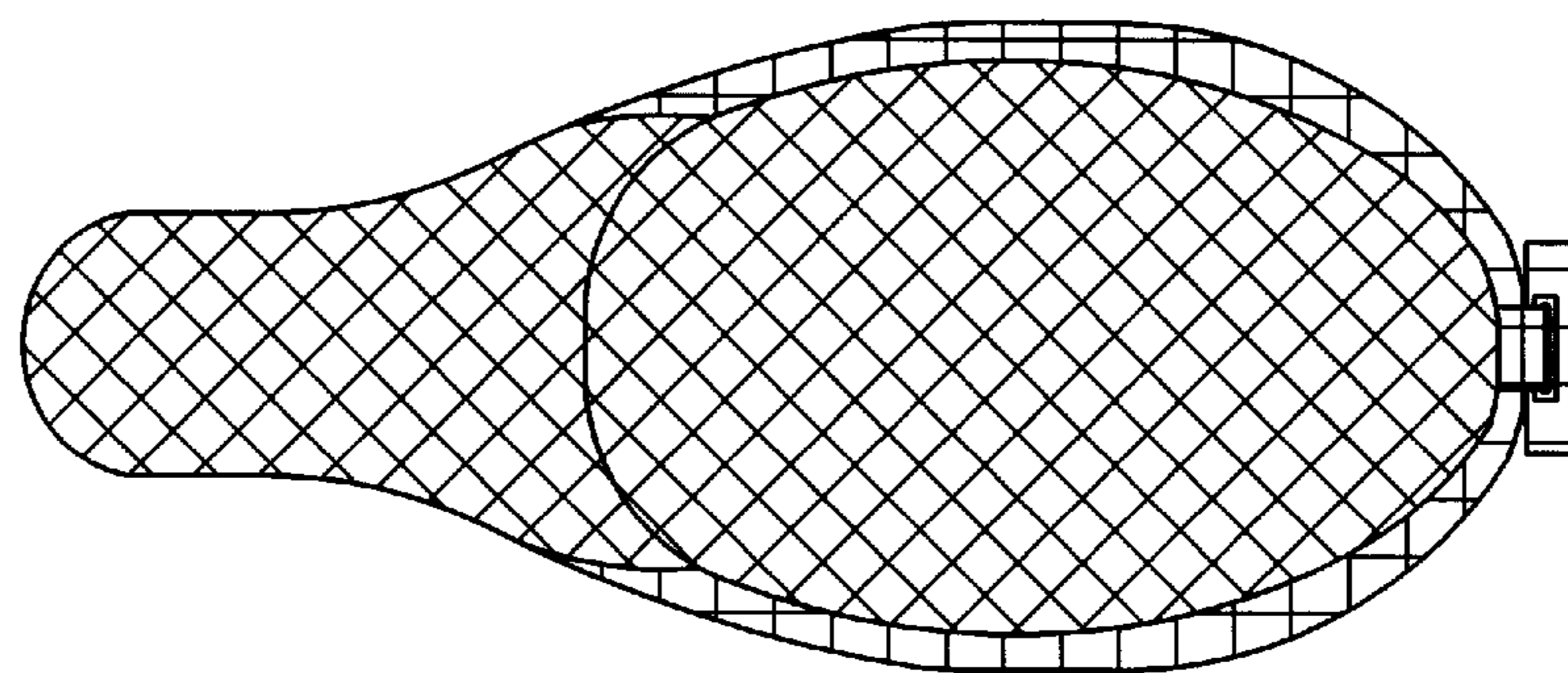

FIG. 21

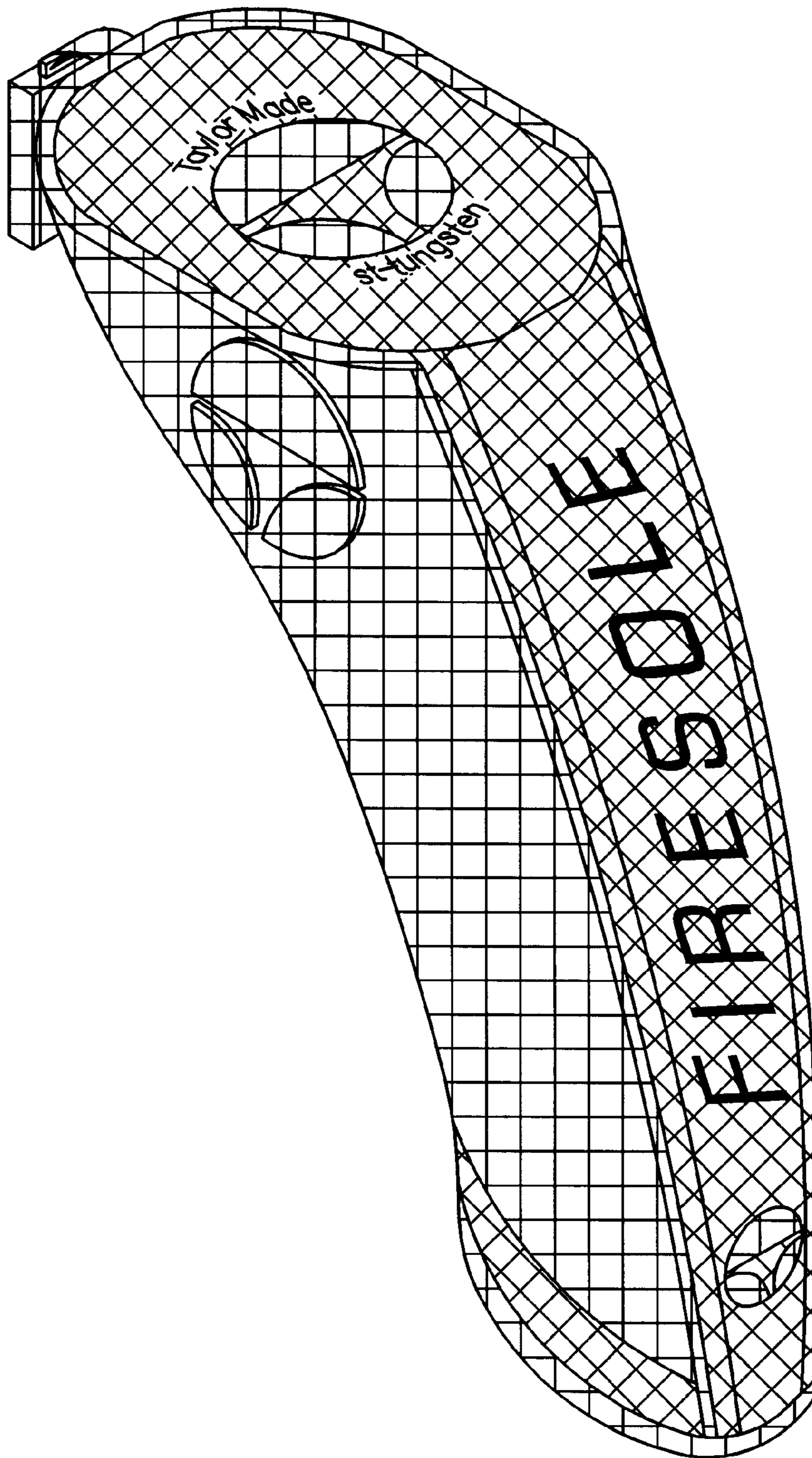

FIG. 22

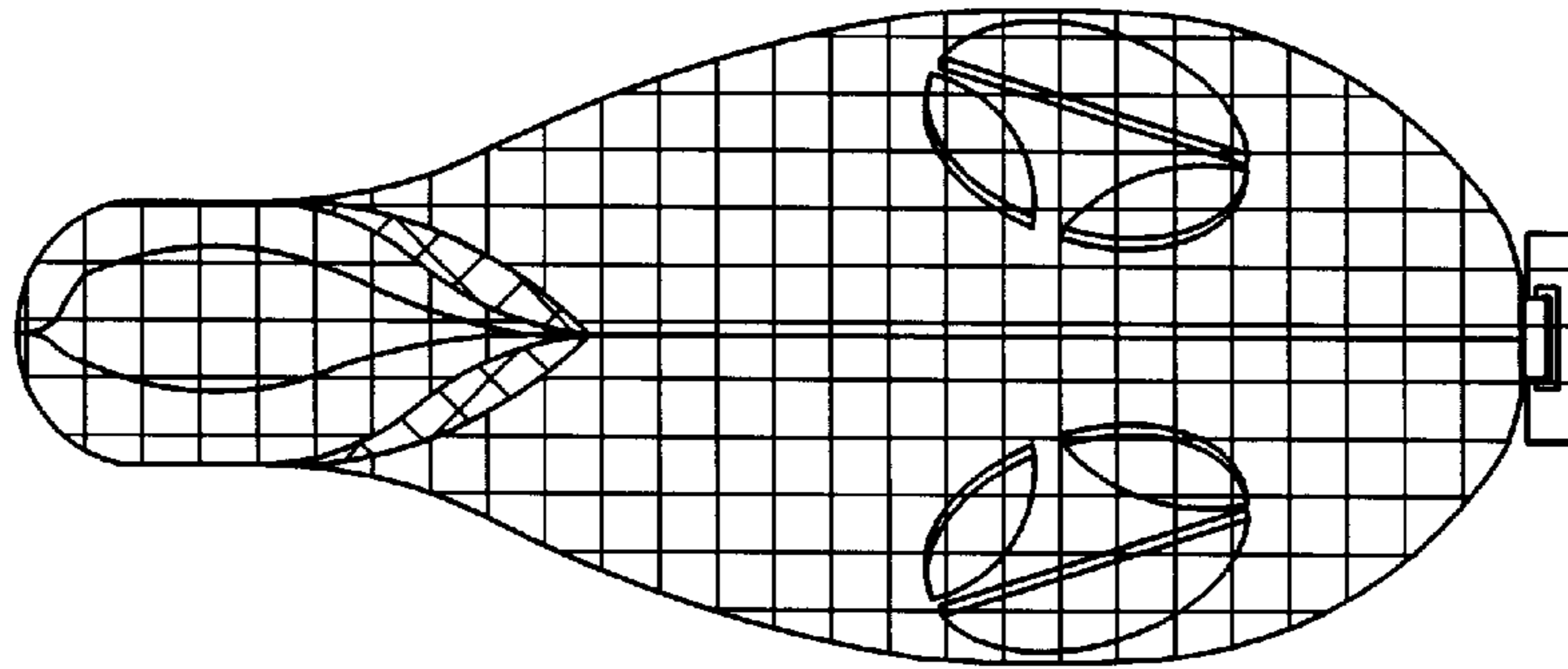

FIG. 23

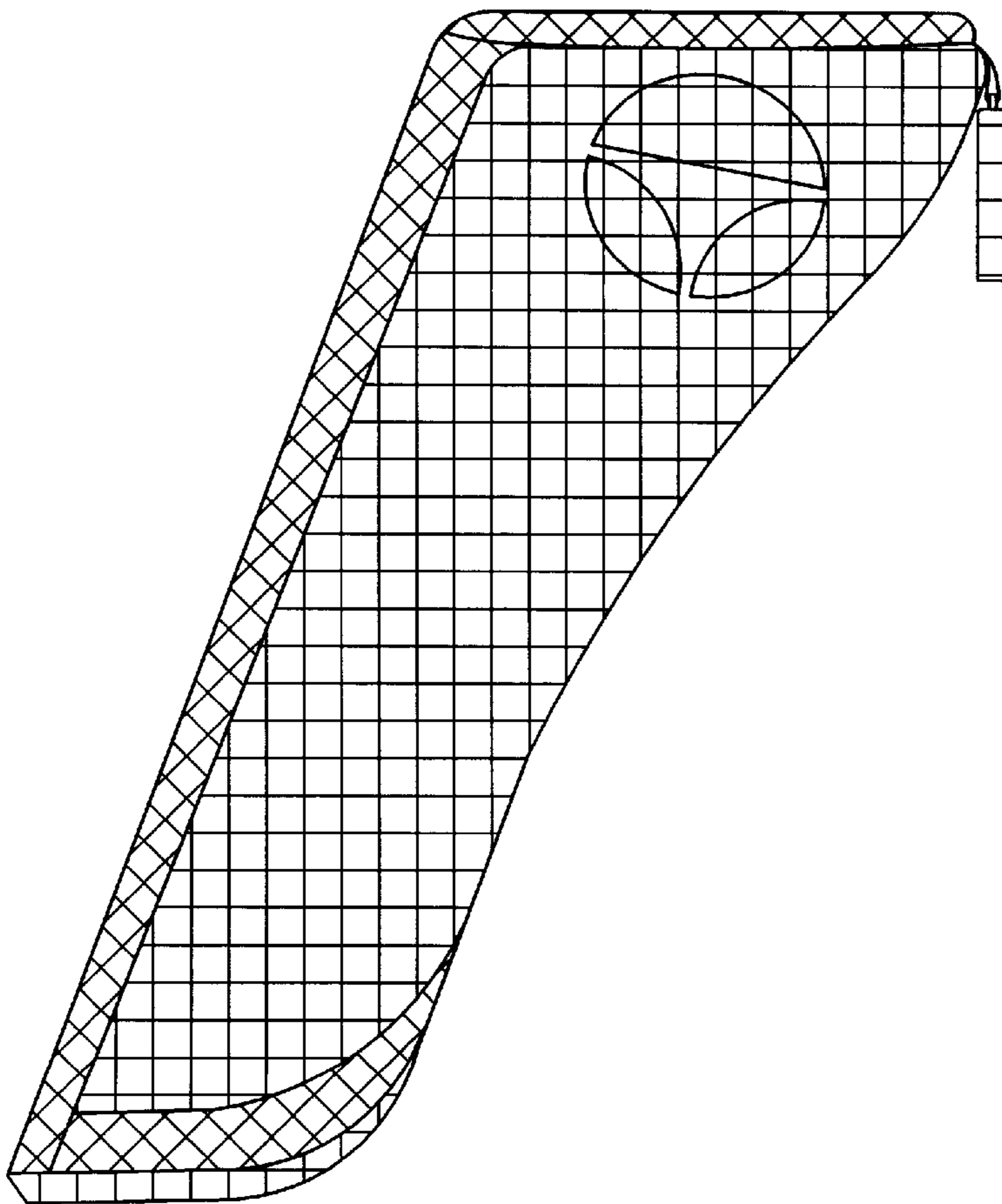

FIG. 24

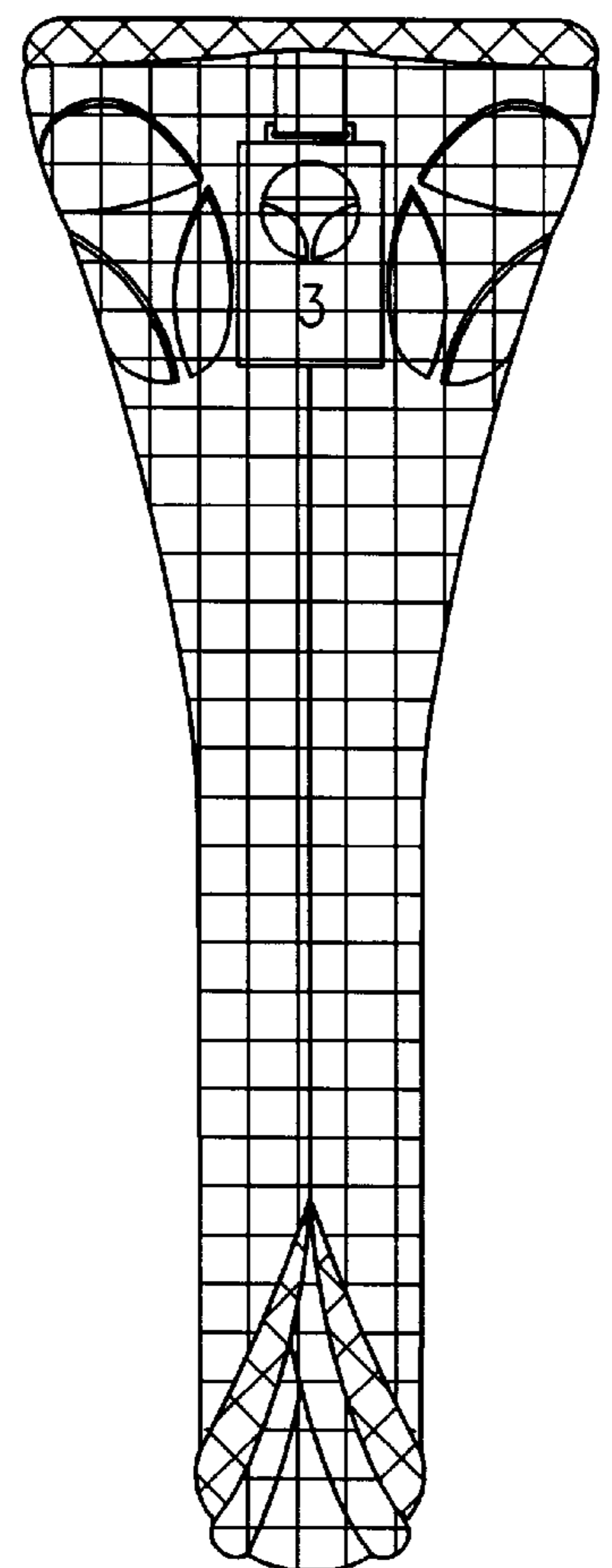

FIG. 25

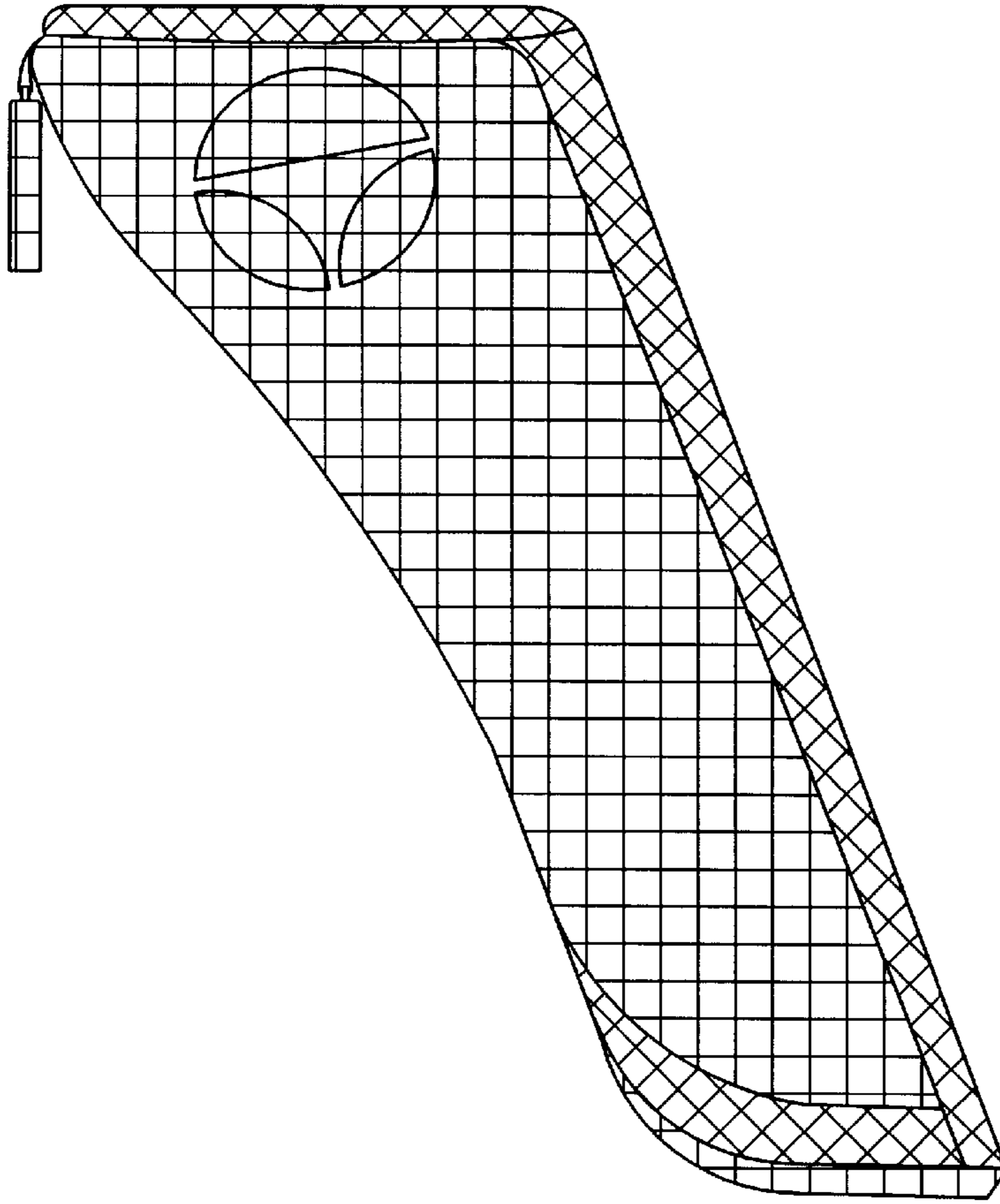

FIG. 26

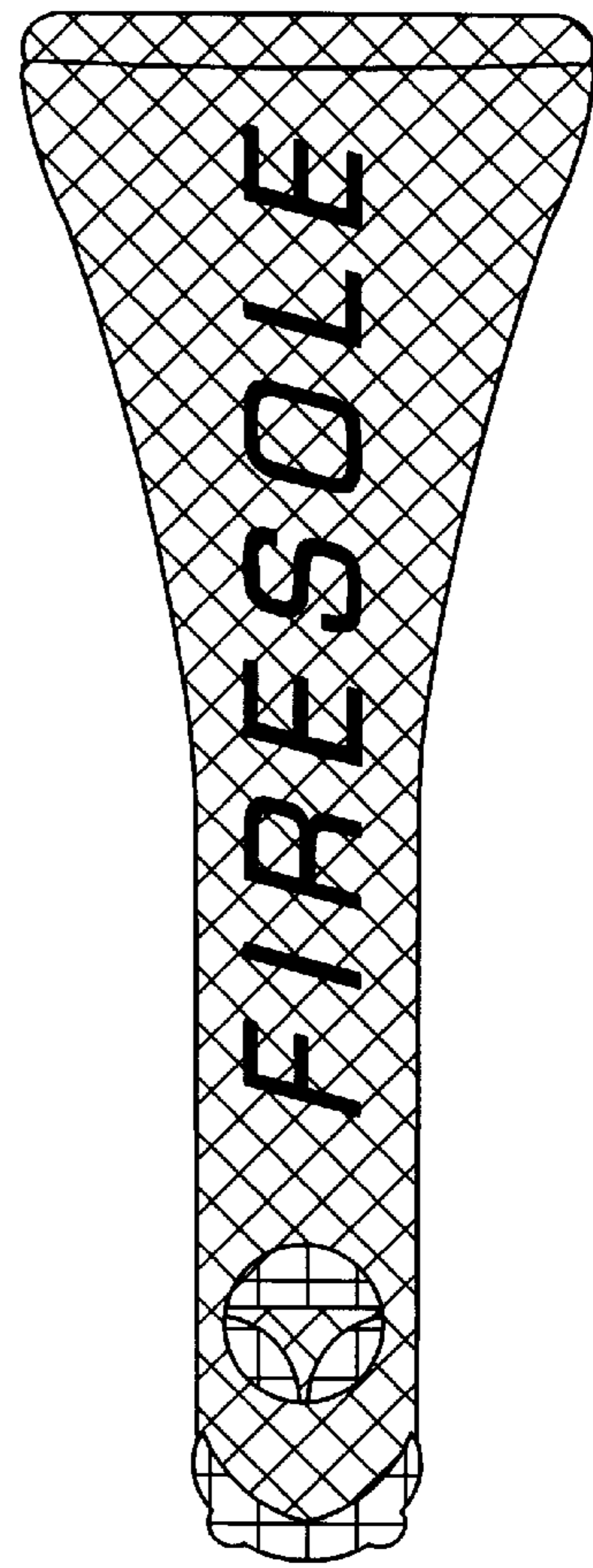

FIG. 27

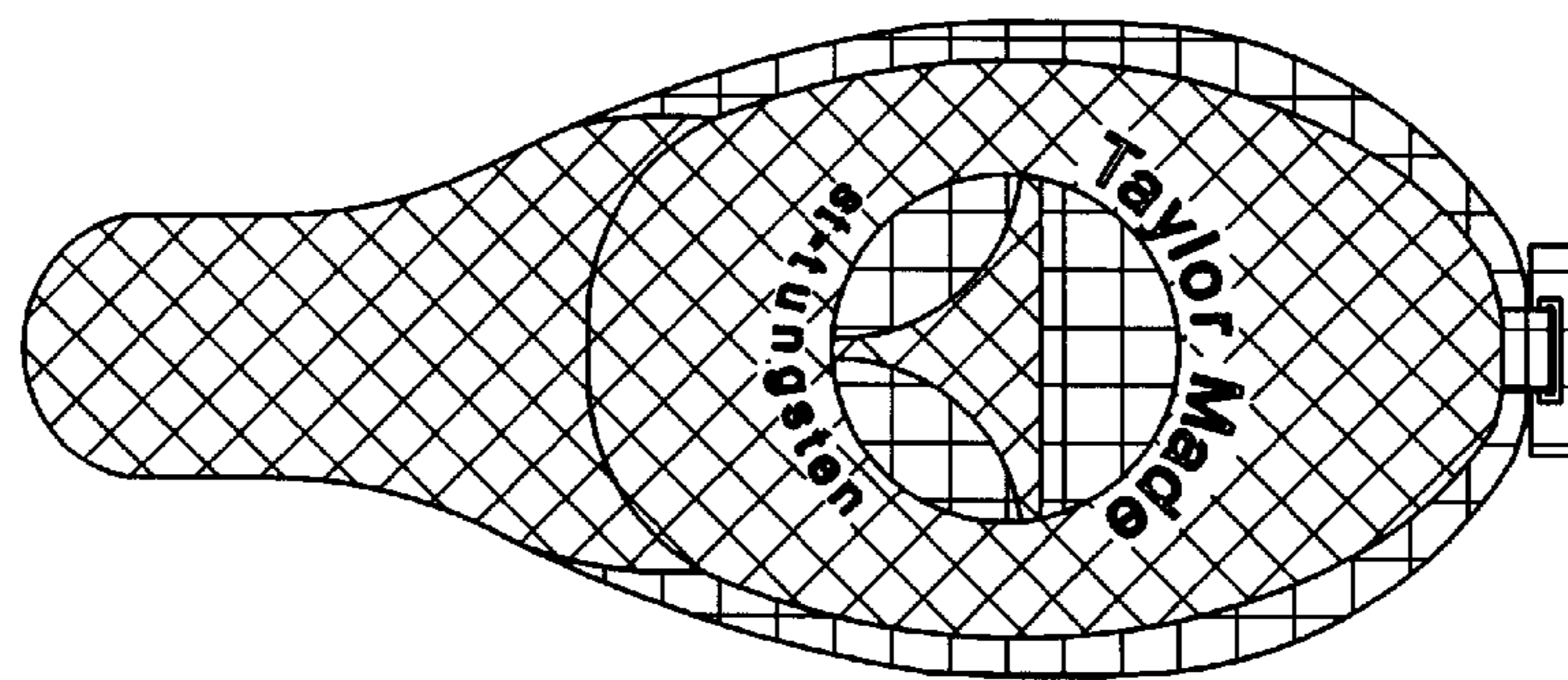

FIG. 28

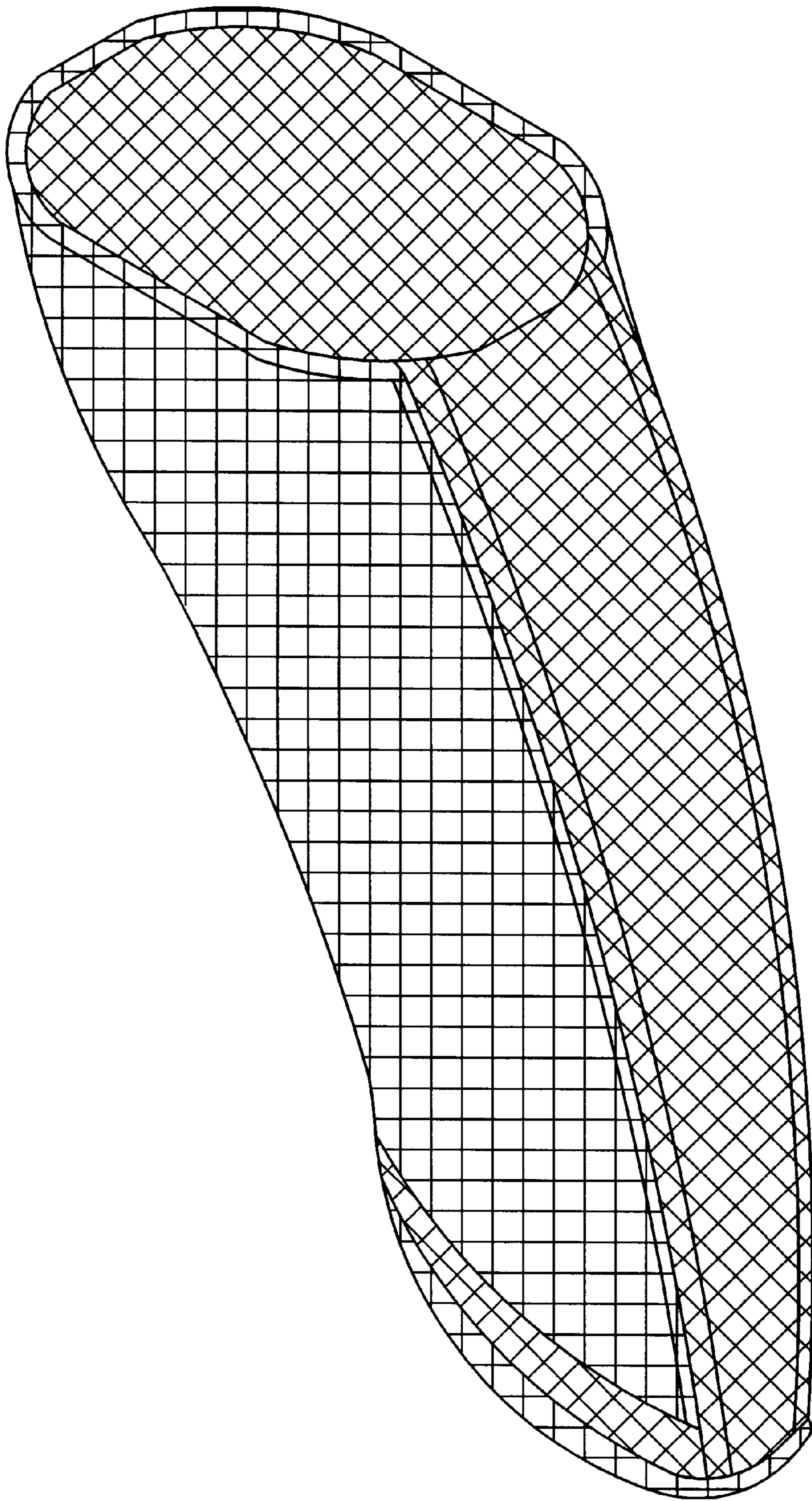

FIG. 29

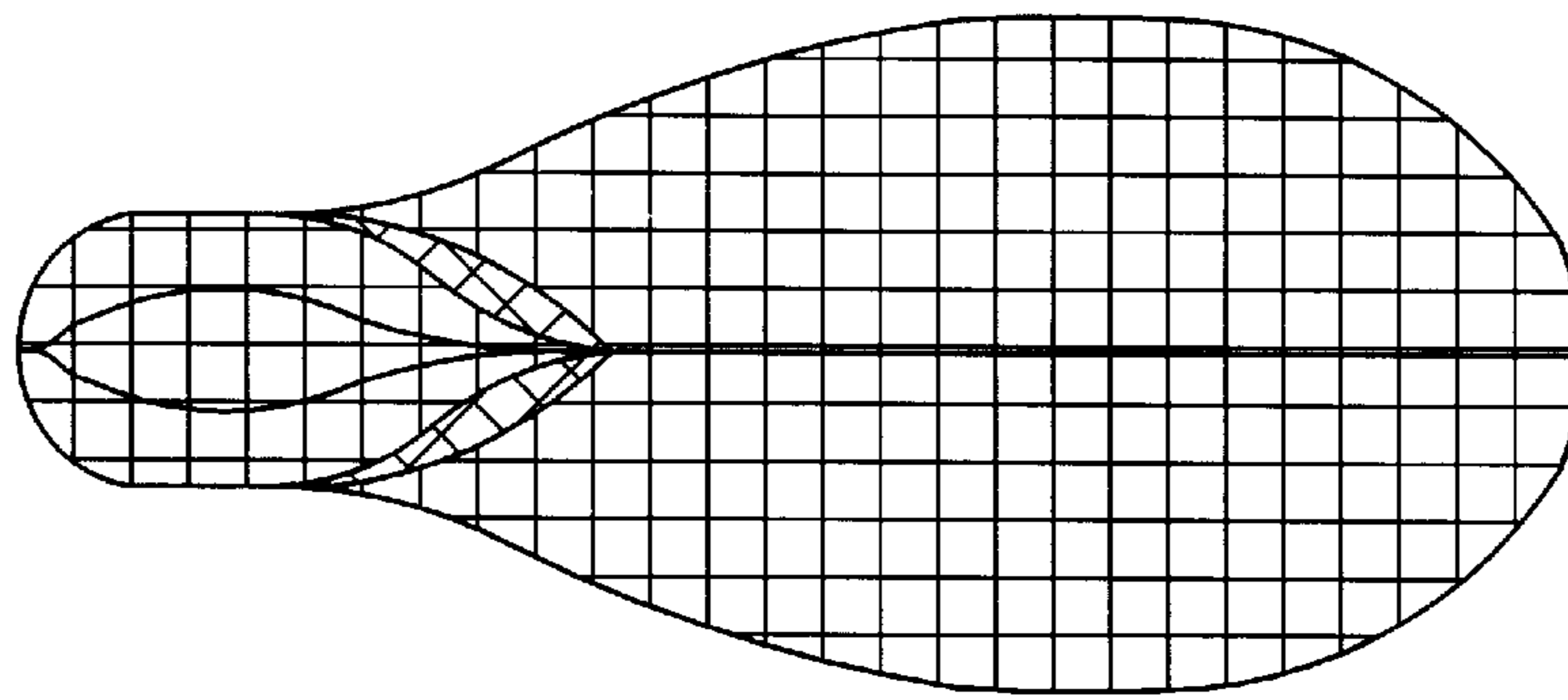

FIG. 30

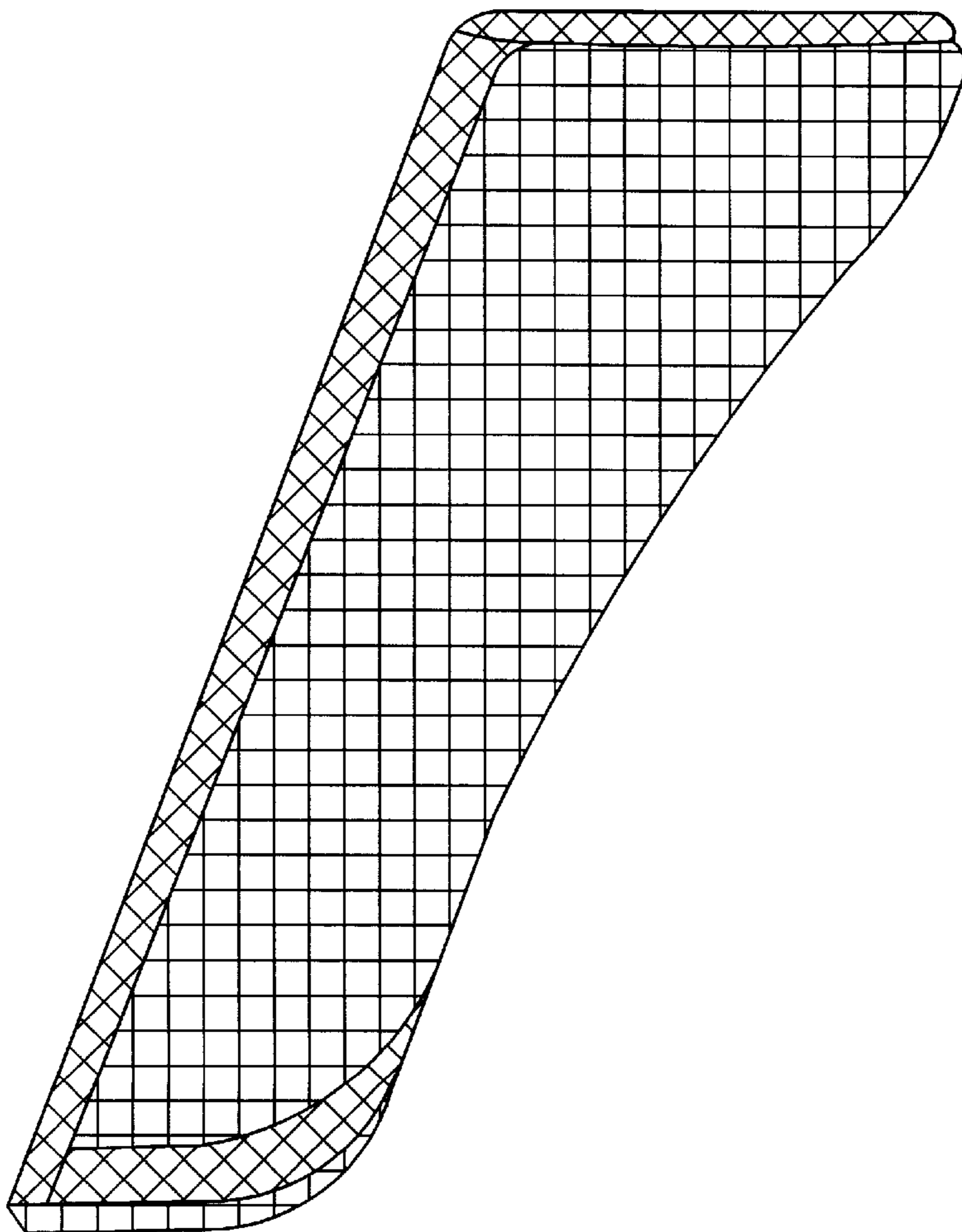

FIG. 31

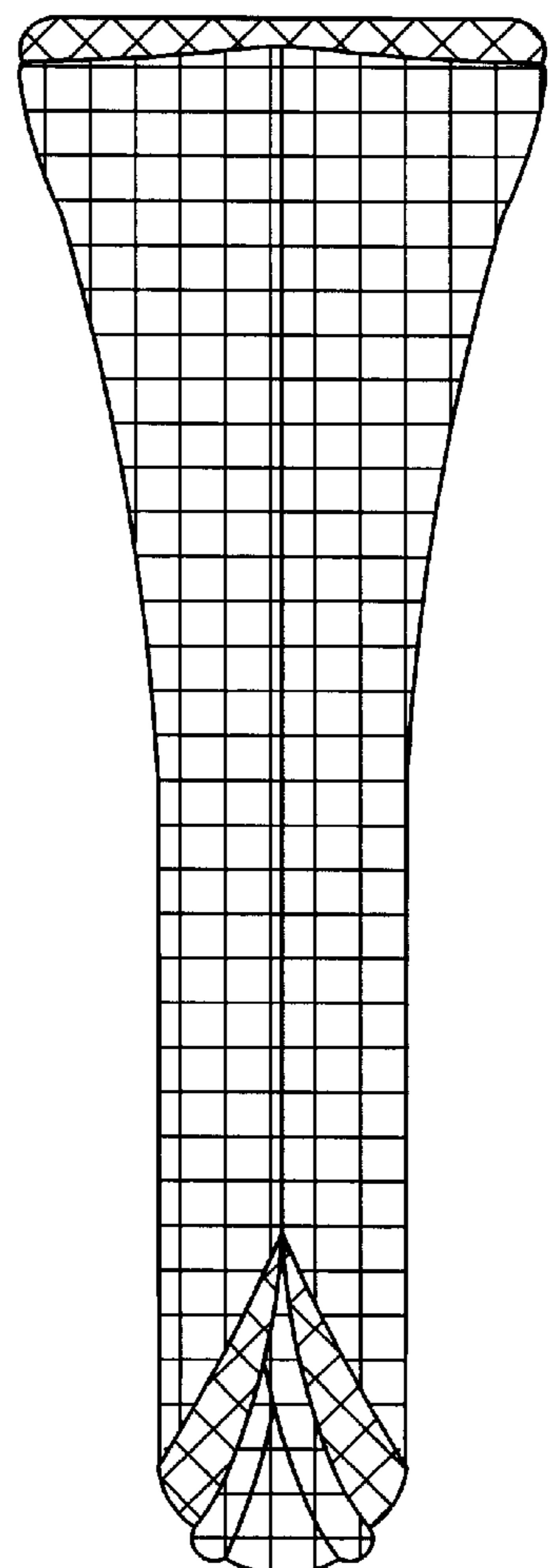

FIG. 32



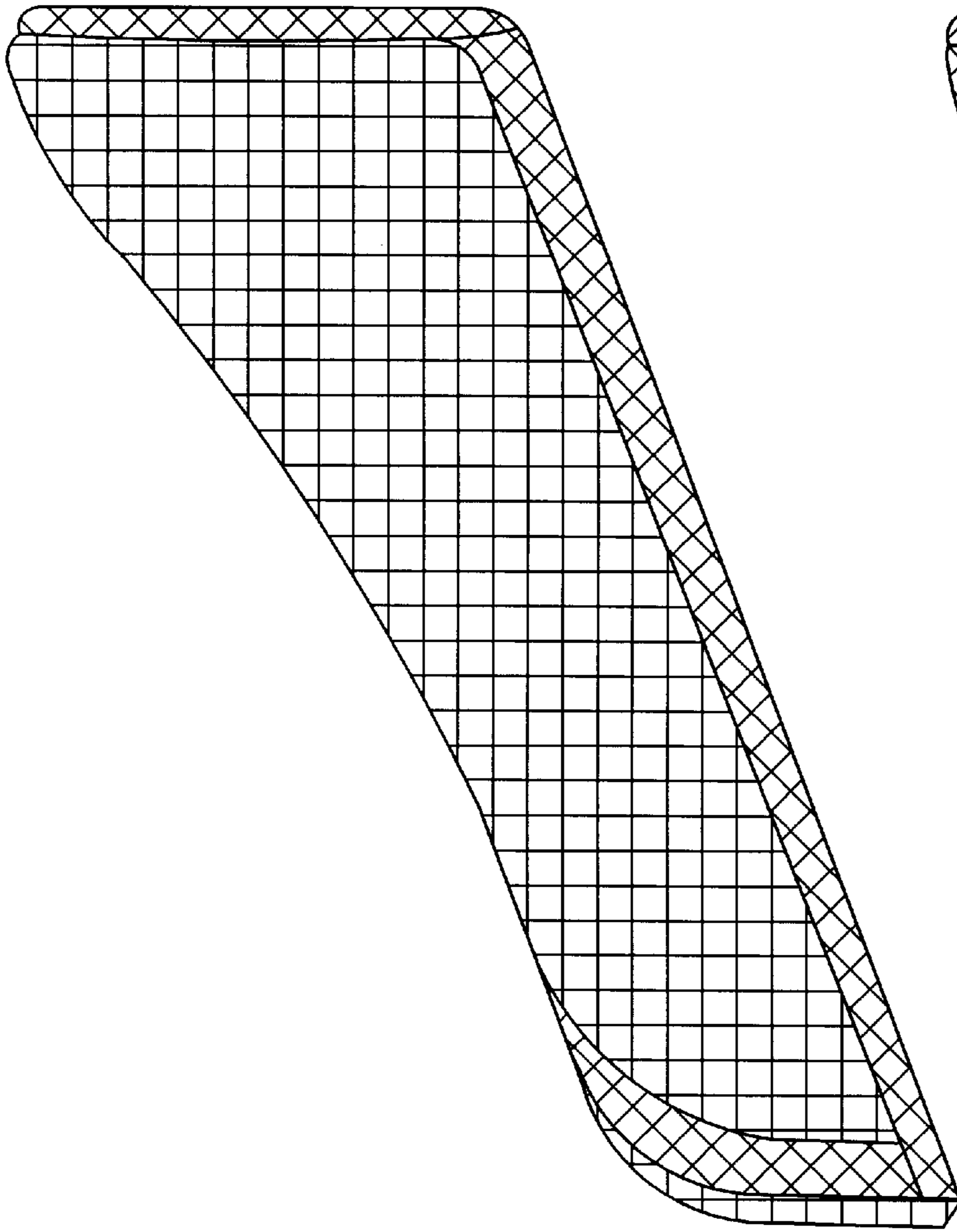

FIG. 33

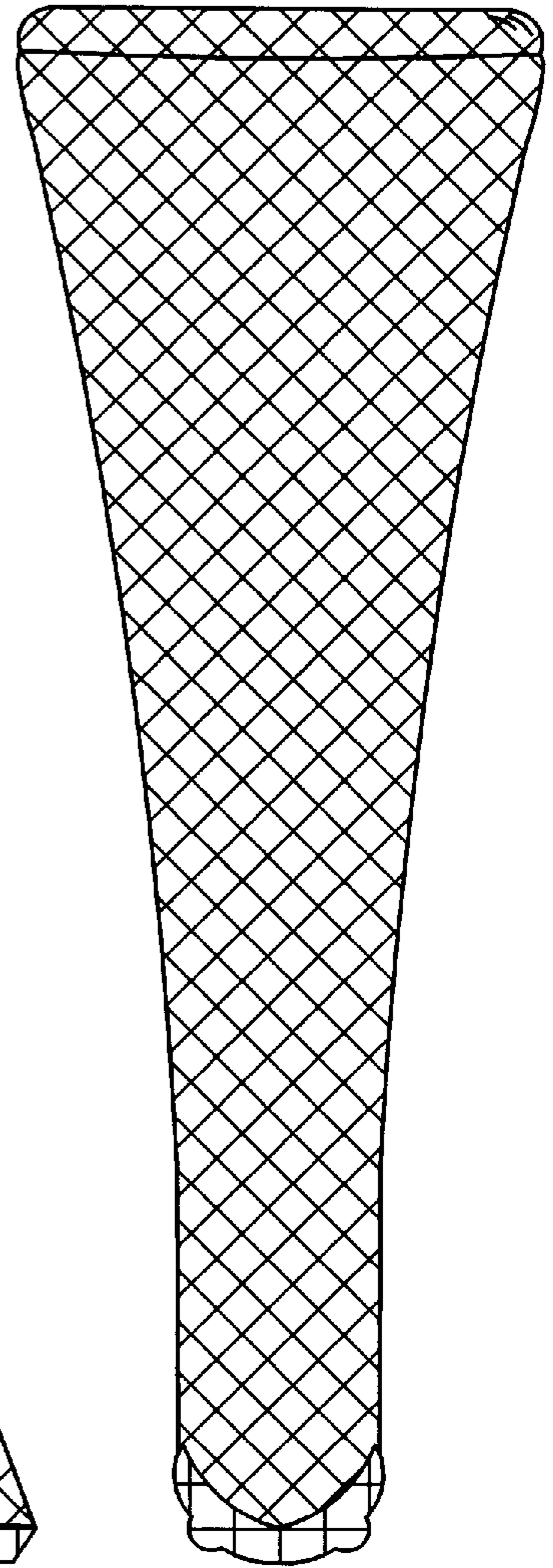

FIG. 34

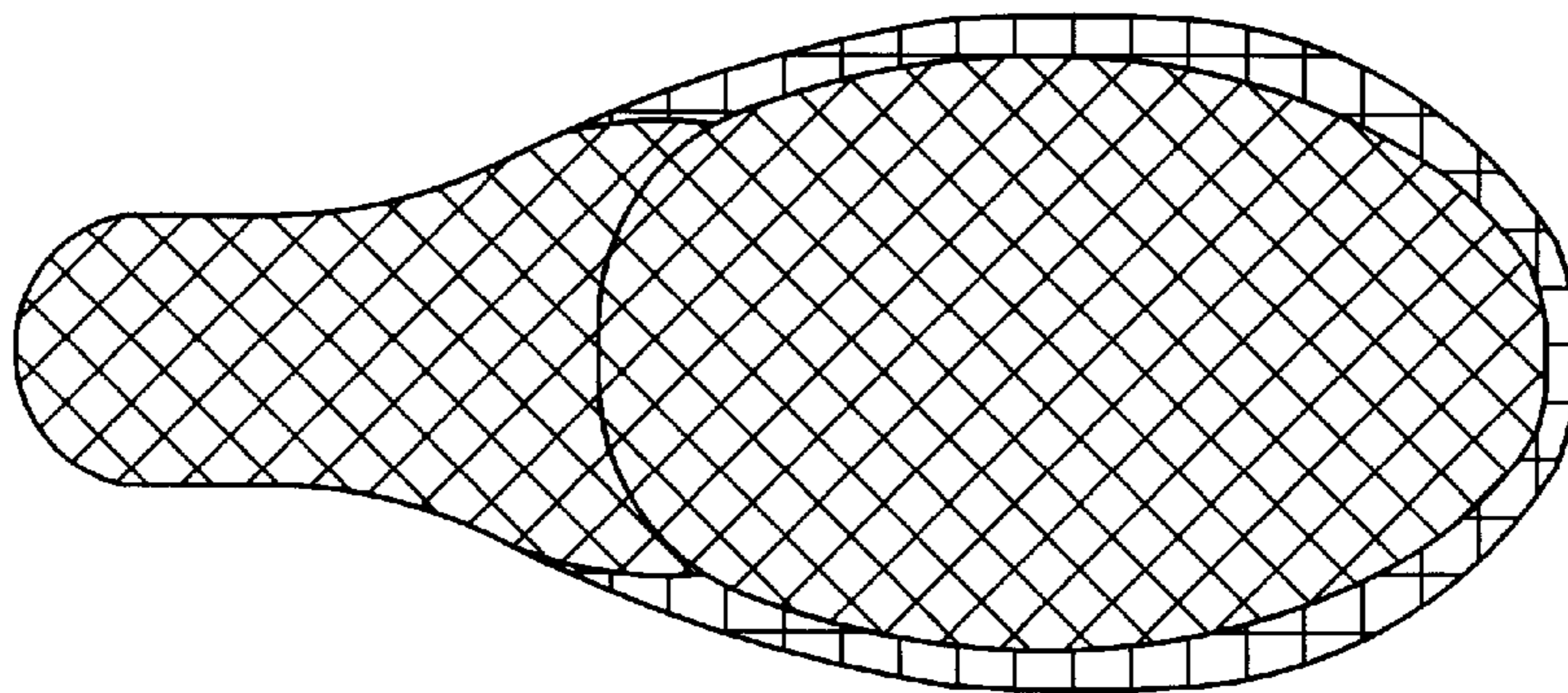

FIG. 35

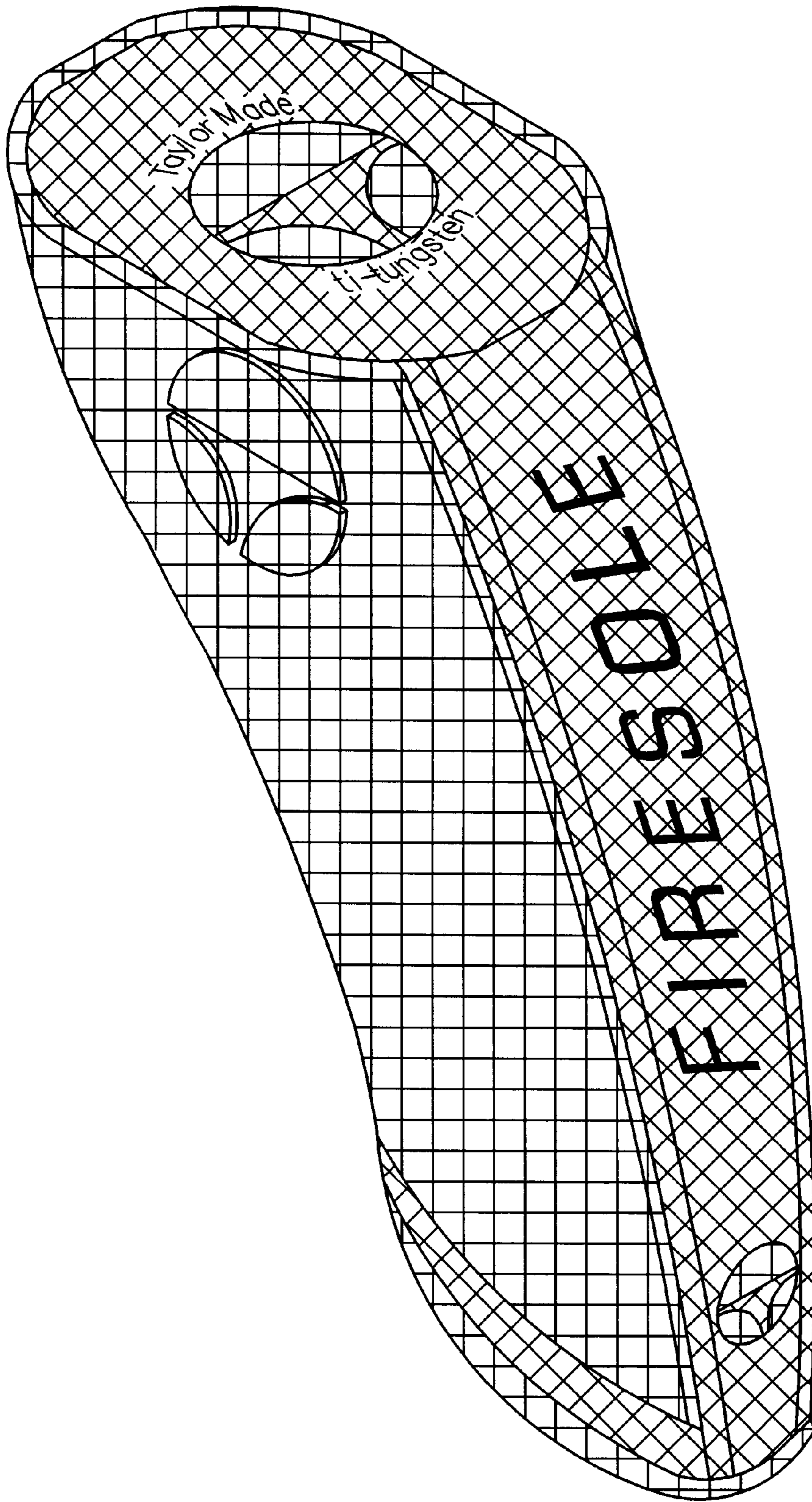

FIG. 36

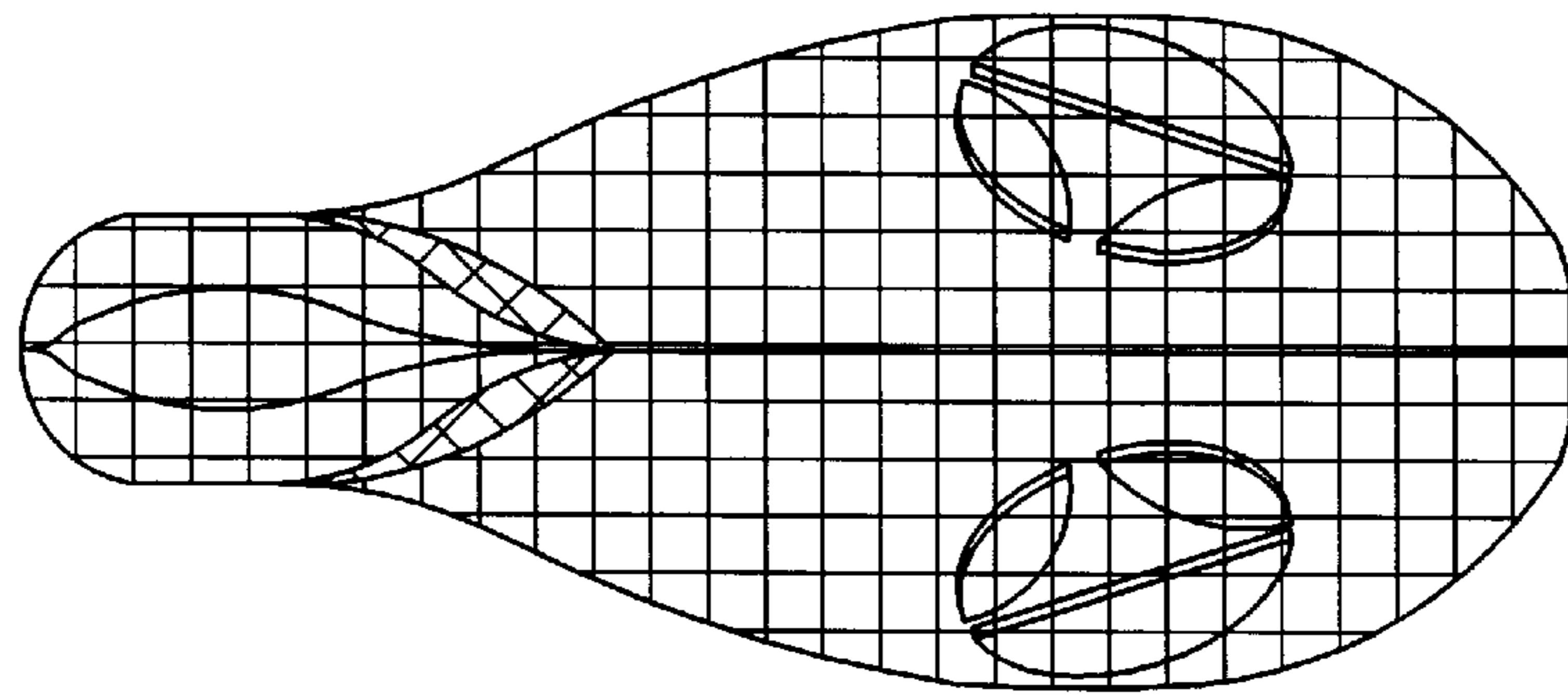

FIG. 37

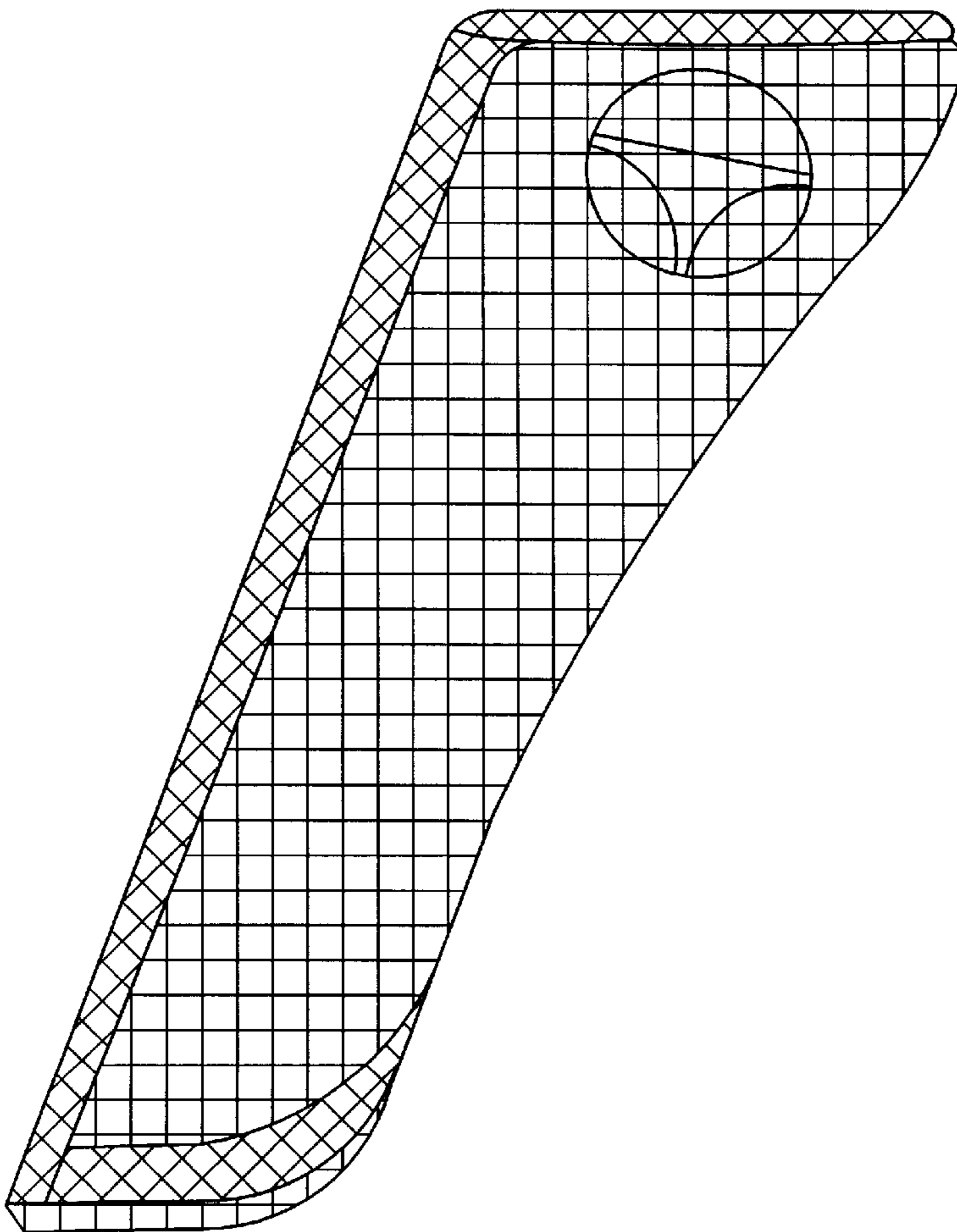

FIG. 38

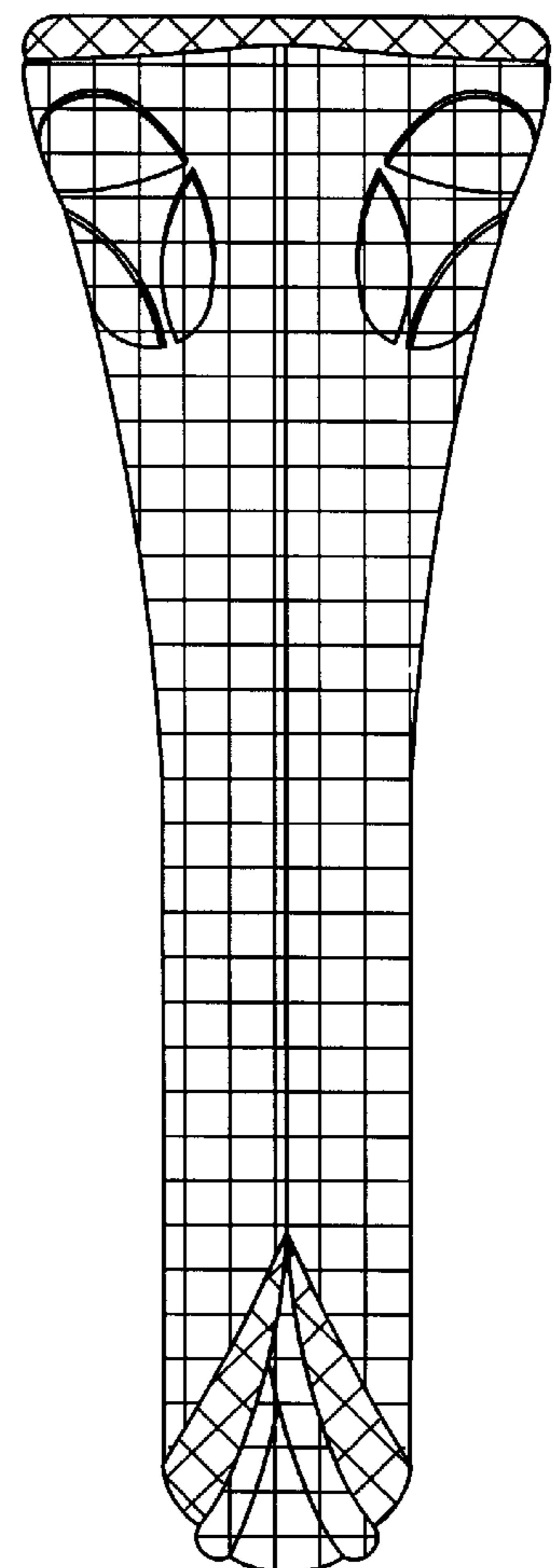

FIG. 39

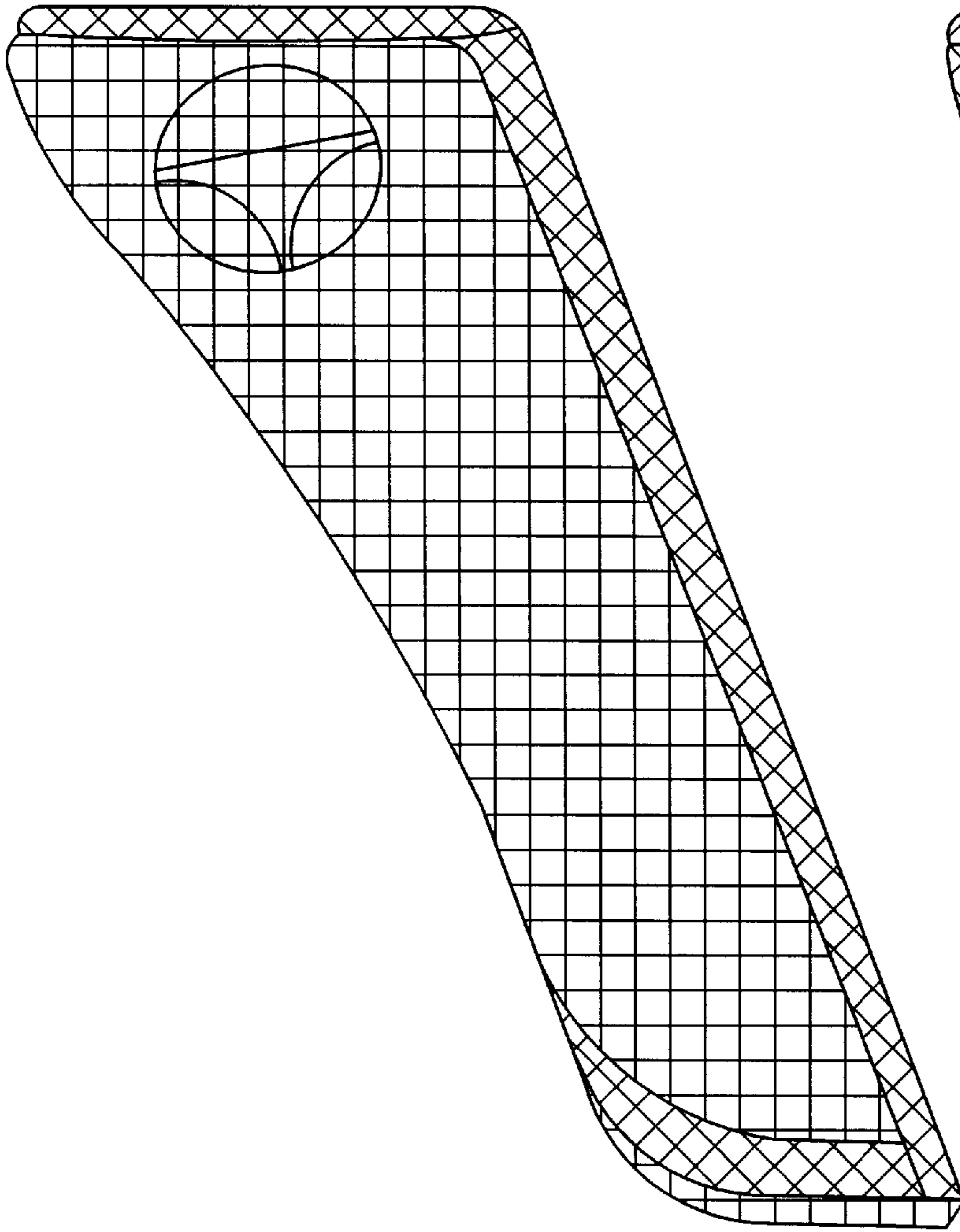

FIG. 40

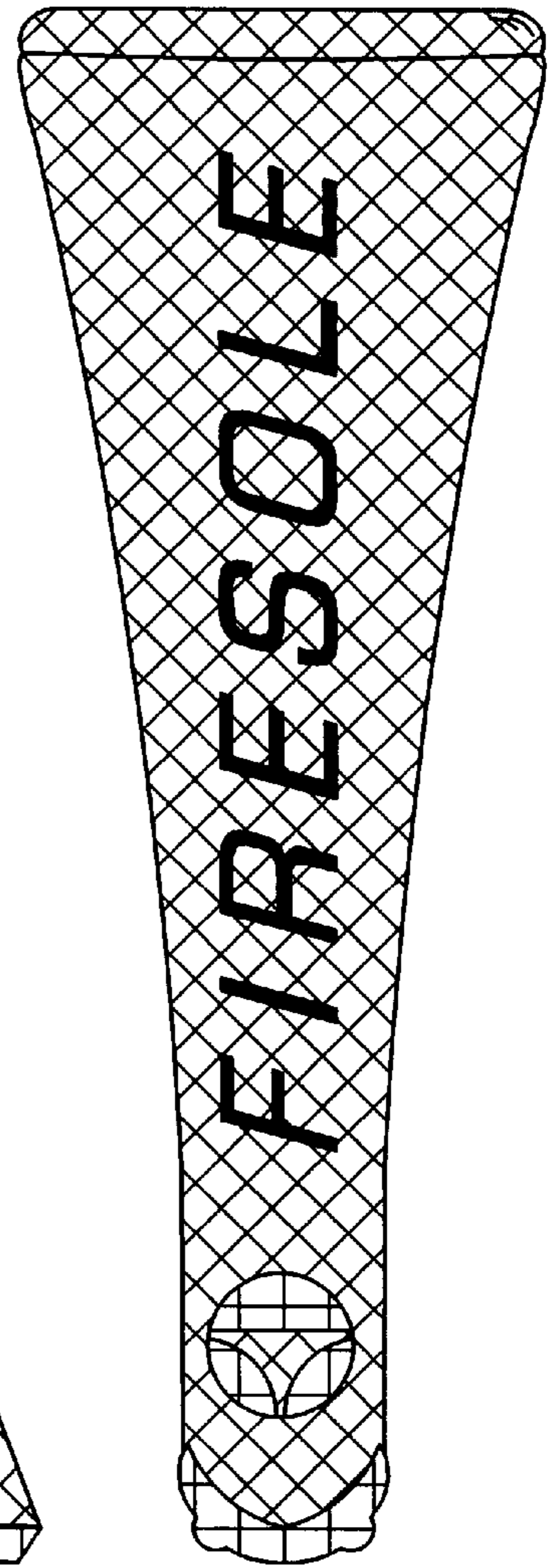

FIG. 41

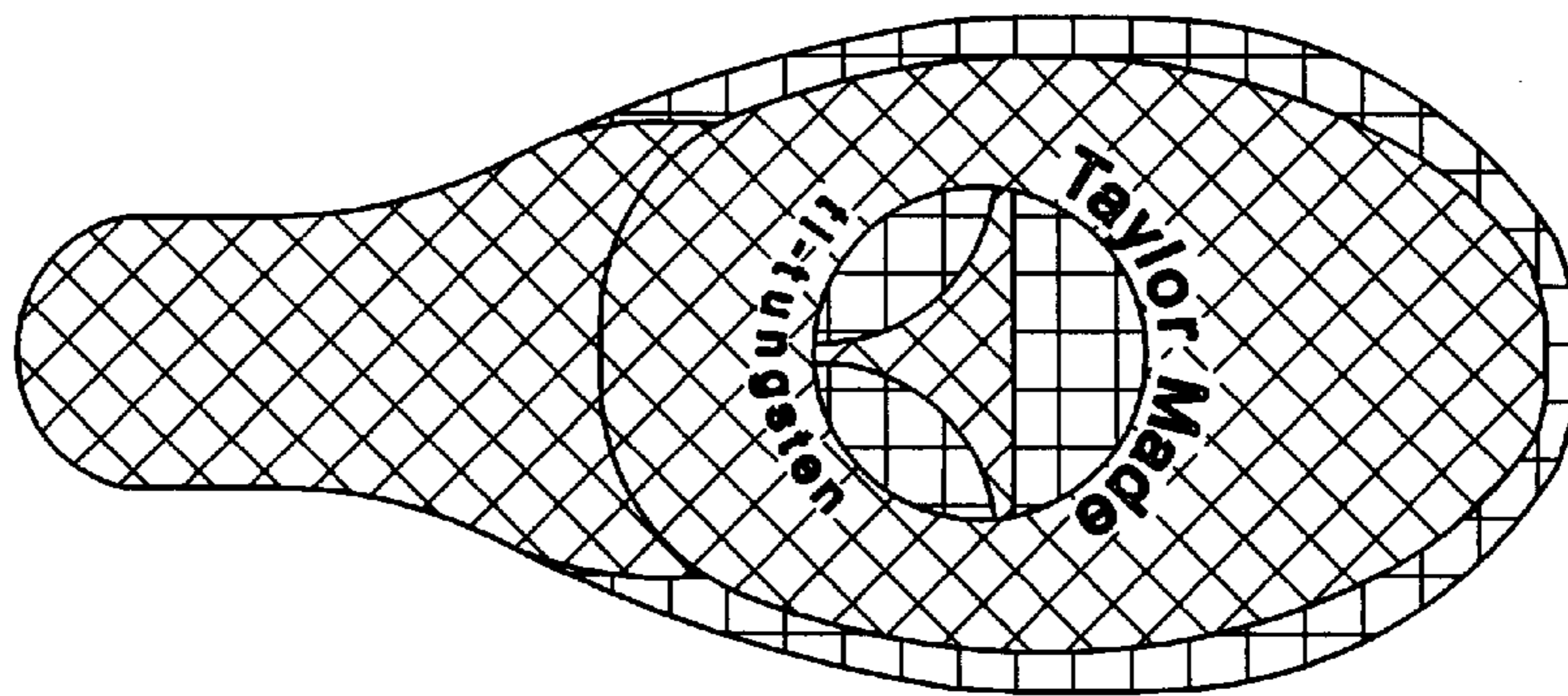

FIG. 42