



US00D439161S

(12) **United States Design Patent**  
**Rondolino**

(10) **Patent No.:** **US D439,161 S**

(45) **Date of Patent:** **\*\* Mar. 20, 2001**

(54) **CONTAINER FOR FOOD PRODUCTS**

(75) **Inventor:** **Andrea Rondolino, Asti (IT)**

(73) **Assignee:** **Il Poggio Di Vaglierano S.A.S. Di Rondolino A. E C., Turin (IT)**

(\*\*) **Term:** **14 Years**

(21) **Appl. No.:** **29/106,699**

(22) **Filed:** **Jun. 22, 1999**

(30) **Foreign Application Priority Data**

Dec. 22, 1998 (IT) ..... TO9800327

(51) **LOC (7) Cl.** ..... **09-03**

(52) **U.S. Cl.** ..... **D9/430**

(58) **Field of Search** ..... D7/602, 610, 629;  
D9/414, 430-433, 438, 416; 206/270, 276;  
229/107, 149, 245

(56) **References Cited**

**U.S. PATENT DOCUMENTS**

D. 57,707	*	4/1921	Morrison	.....	D9/430
D. 260,487	*	9/1981	Grubman et al.	.....	D9/432
D. 274,603	*	7/1984	Lien et al.	.....	D9/431
D. 349,050	*	7/1994	Krupa	.....	D9/430
883,734	*	4/1908	Morrison	.....	D9/433
1,158,046	*	10/1915	Haines	.....	229/107
2,130,445	*	9/1938	Bemiss	.....	229/939

2,452,969	*	11/1948	Victor	.....	229/107
2,789,608	*	4/1957	Tupper	.....	D7/610
3,715,050	*	2/1973	Batchelar et al.	.....	220/270
3,876,131	*	4/1975	Tolaas	.....	206/551
3,908,523	*	9/1975	Shikaya	.....	229/939
4,373,636	*	2/1983	Hoffman	.....	229/107
4,784,273	*	11/1988	Niemetz	.....	229/107
4,801,075	*	1/1989	Weber et al.	.....	206/551
4,990,345	*	2/1991	Webb	.....	D7/629

\* cited by examiner

*Primary Examiner*—Ted Shooman

*Assistant Examiner*—Carol Rademaker

(74) *Attorney, Agent, or Firm*—Sughrue, Mion, Zinn, Macpeak & Seas, PLLC

(57) **CLAIM**

I claim the ornamental design for a container for food products, as shown and described.

**DESCRIPTION**

FIG. 1 is a perspective view of the container for food products showing my new design;  
FIG. 2 is a reduced front view thereof;  
FIG. 3 is a reduced right view thereof;  
FIG. 4 is a reduced left view thereof;  
FIG. 5 is a reduced rear view thereof;  
FIG. 6 is a reduced top view thereof; and,  
FIG. 7 is a reduced bottom view thereof.

**1 Claim, 2 Drawing Sheets**

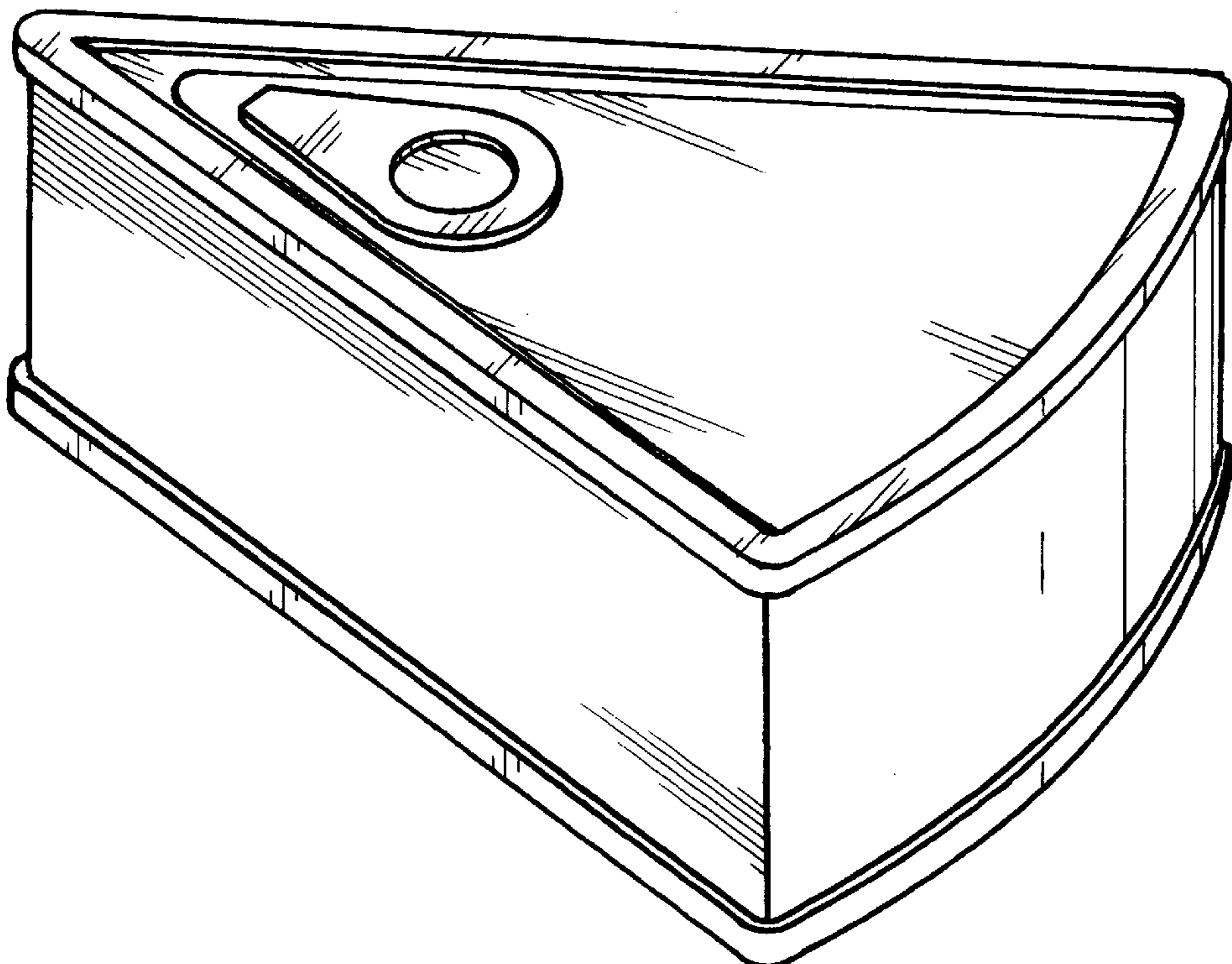

FIG. 1

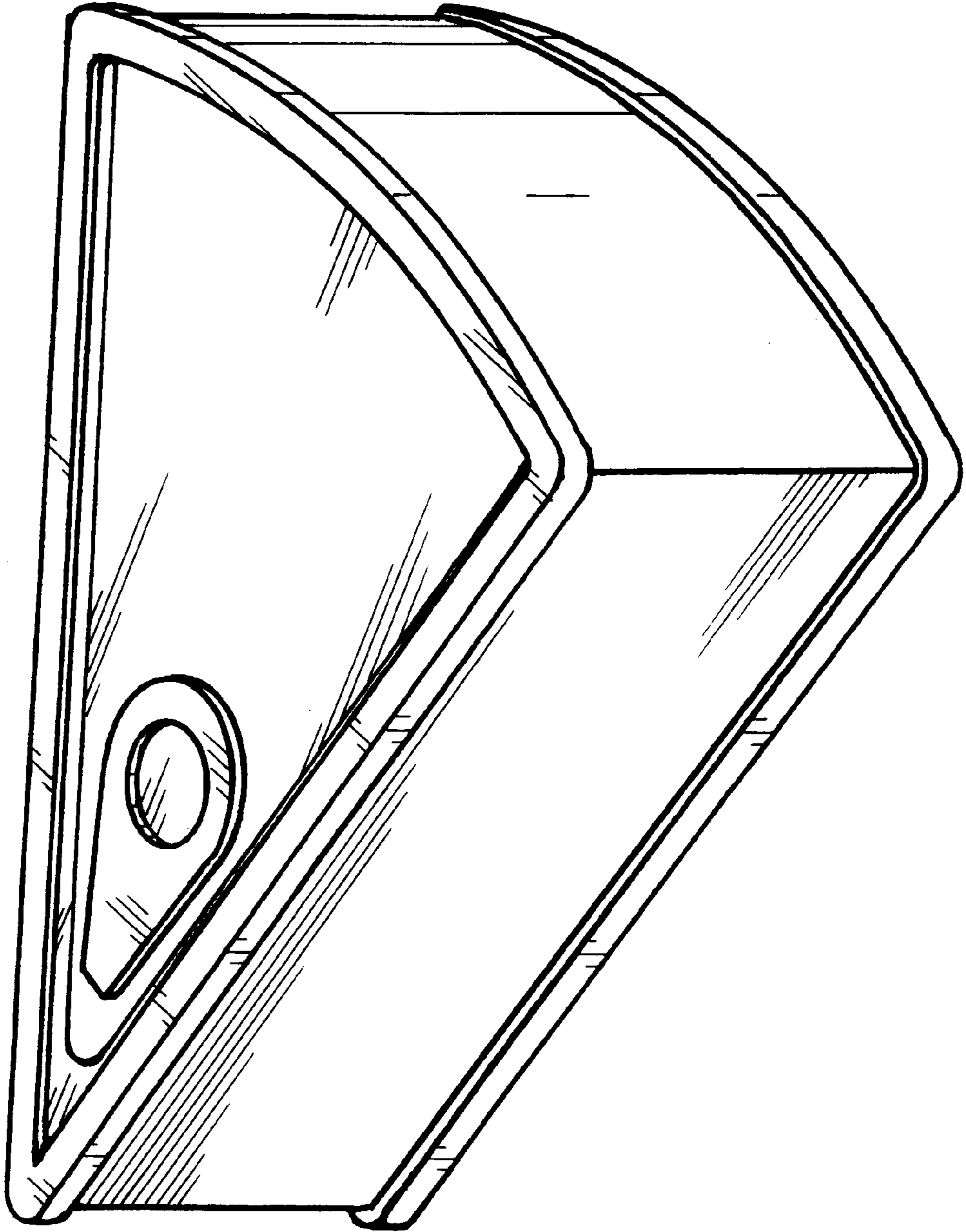

FIG. 2

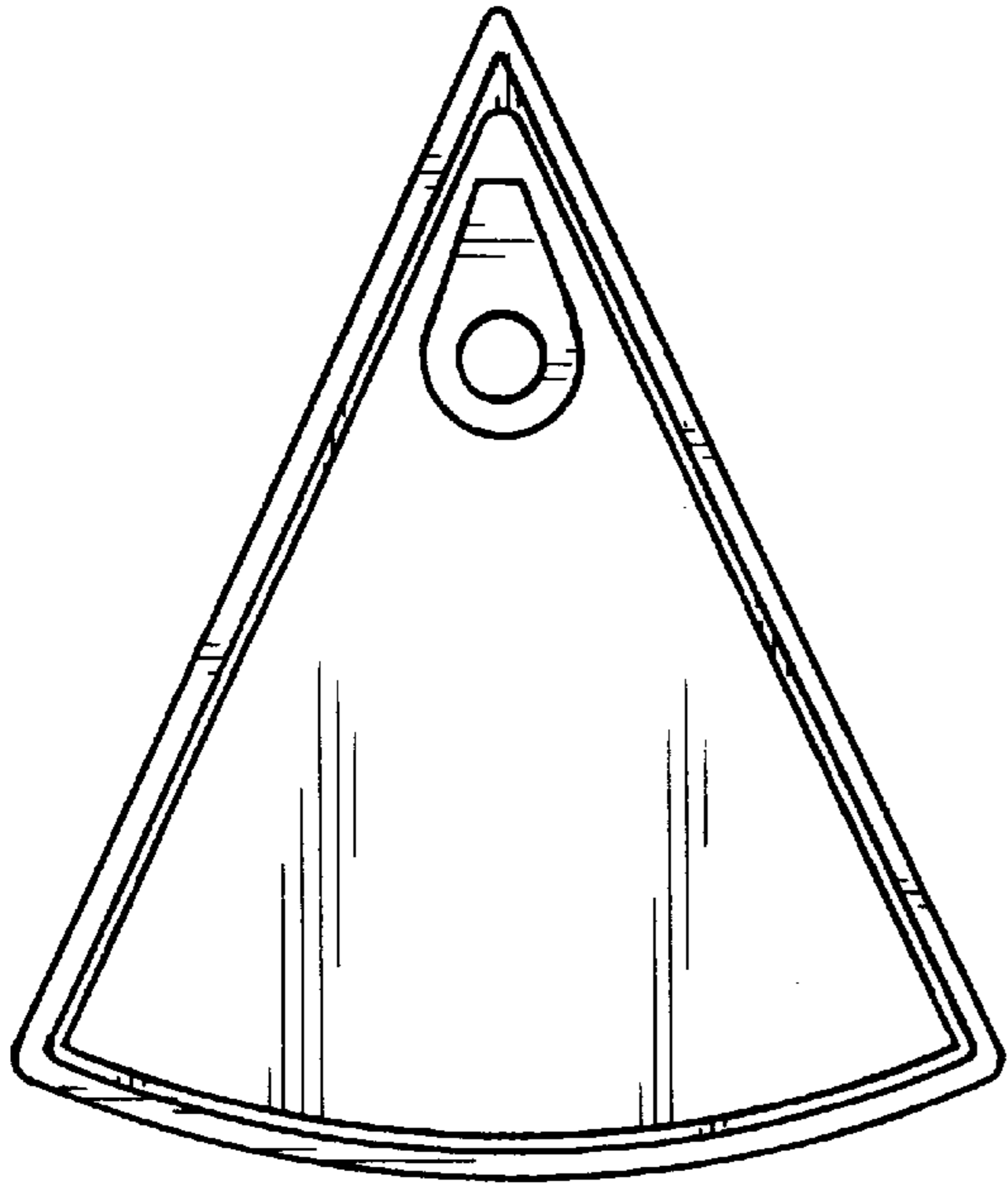

FIG. 3

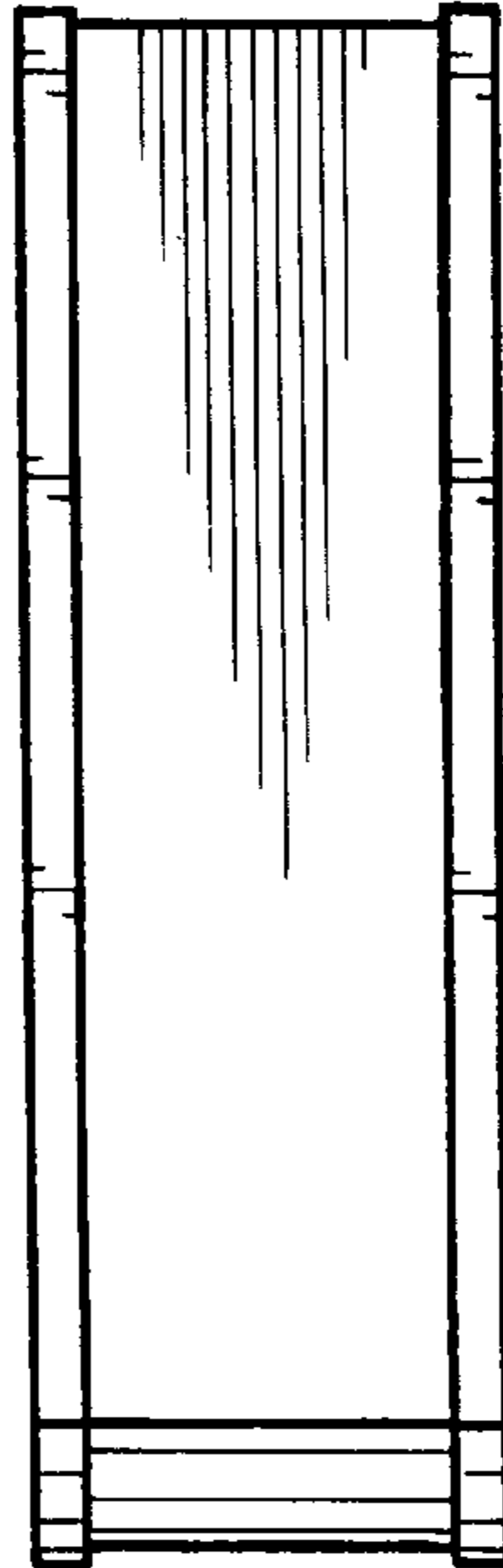

FIG. 4

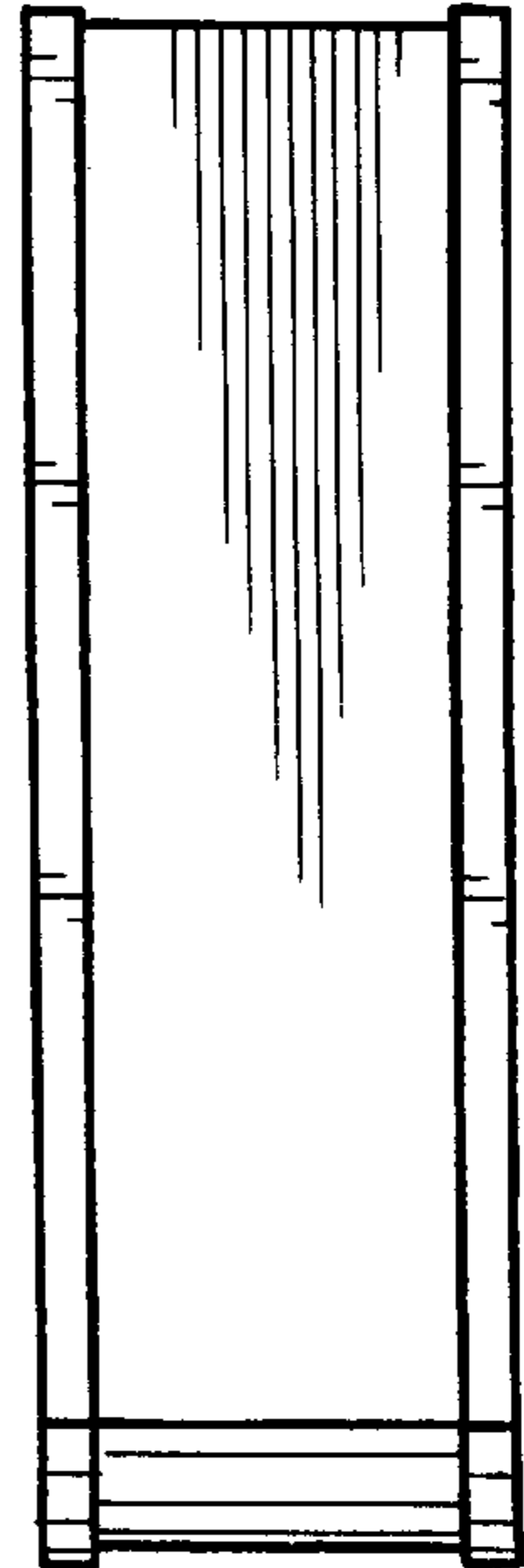

FIG. 5

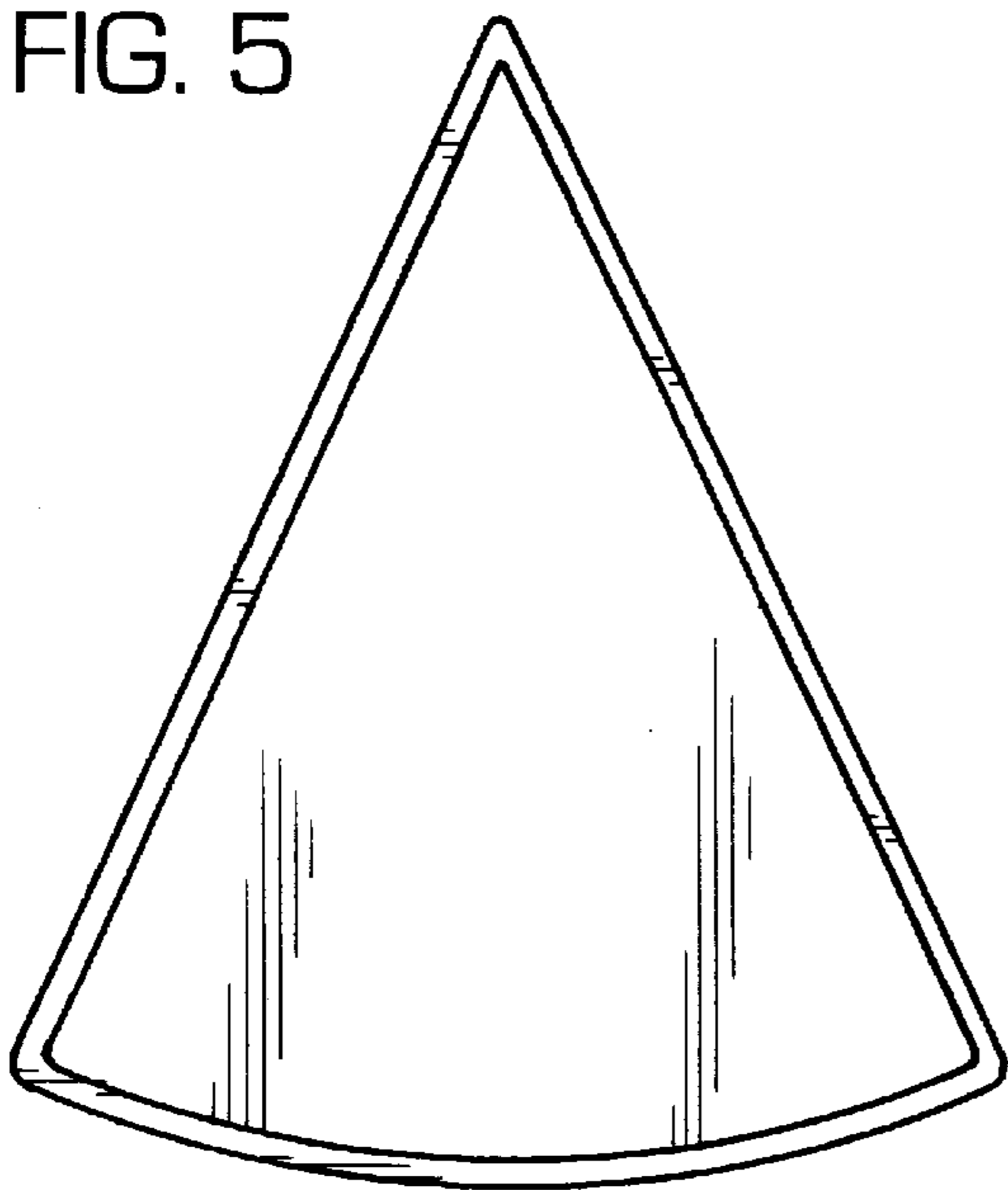

FIG. 6

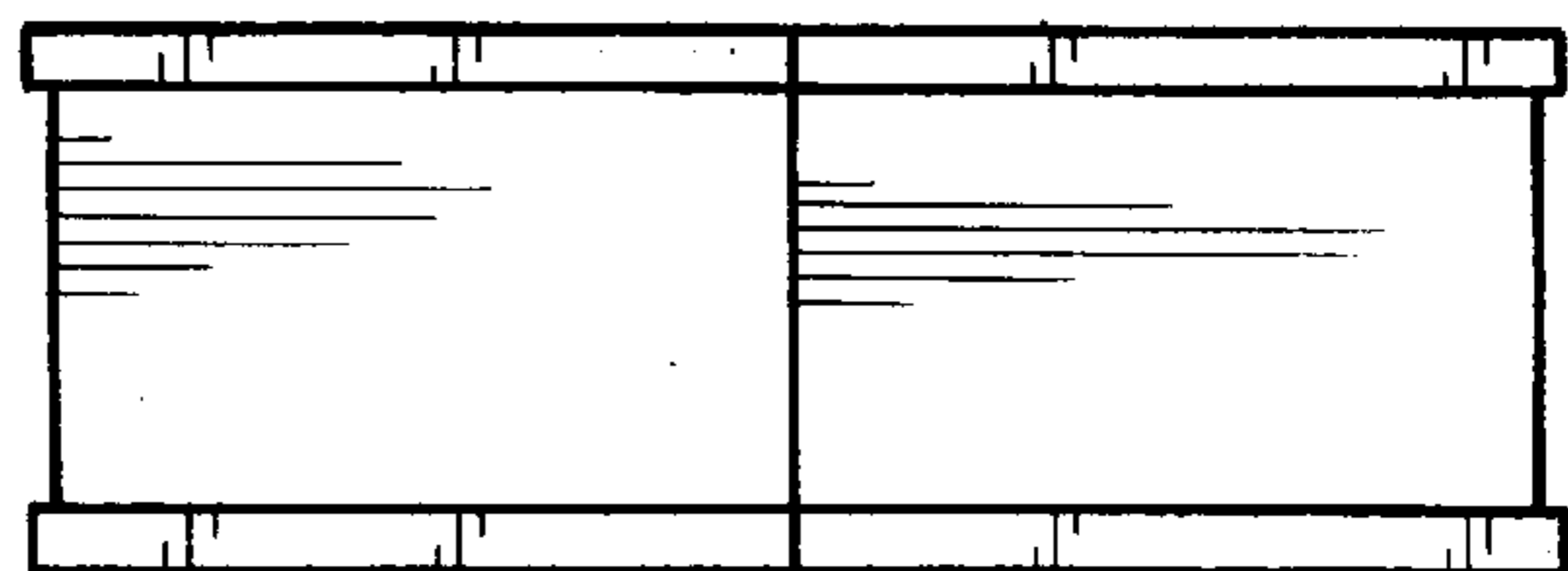

FIG. 7

