



US00D439156S

(12) **United States Design Patent**
Hall et al.

(10) **Patent No.:** **US D439,156 S**

(45) **Date of Patent:** **** Mar. 20, 2001**

(54) **SET OF INTERLOCKING BOTTLES**

FOREIGN PATENT DOCUMENTS

(76) Inventors: **Jack P. Hall**, 877 Ames Ave., Palo Alto, CA (US) 94303; **David Merrill**, 22122 Summit Hill Dr., Lake Forest, CA (US) 92630; **Brian J. Olson**, 1463 Greenwood Rd., Pleasanton, CA (US) 94566; **James M. Rubenstein**, 1295 Sunnyhills Rd., Oakland, CA (US) 94610; **James D. Mitchell**, 1694 Cervato Cir., Alamo, CA (US) 94507; **Katie K. Chow**, 1456 S. Mayfair Ave., Daly City, CA (US) 94015

75425 1/1995 (CA) .

Primary Examiner—Lucy Lieberman
(74) *Attorney, Agent, or Firm*—Joel J. Hayashida

(**) Term: **14 Years**

(57) **CLAIM**

The ornamental design for a set of interlocking bottles, as shown and described.

(21) Appl. No.: **29/114,571**

(22) Filed: **Nov. 24, 1999**

DESCRIPTION

Related U.S. Application Data

(62) Division of application No. 29/057,219, filed on Jul. 19, 1996, now Pat. No. Des. 419,871.

(51) **LOC (7) Cl.** **09-01**

(52) **U.S. Cl.** **D9/341; D9/522; D9/523**

(58) **Field of Search** **D9/341, 522, 523, D9/569, 347, 543, 572, 575; 215/382, 6, 10, 383**

FIG. 1 is a perspective view of a set of interlocking bottles showing my new design;
FIG. 2 is a perspective view of one of the bottles shown separately to clearly disclose the rear wall that interlocks with the other bottle;
FIG. 3 is a rear elevation of FIG. 2;
FIG. 4 is a side elevation of the bottle shown in FIG. 2, the opposite side elevation is a mirror image thereto except for the screw threading on the bottle neck;
FIG. 5 is a front elevation of FIG. 2;
FIG. 6 is a top plan view of FIG. 2;
FIG. 7 is a bottom plan view of FIG. 2;
FIG. 8 is a rear elevation showing one of the bottles of a second embodiment of the set of interlocking bottles that differs from the first embodiment only in the length of the vertical rib on the rear wall;
FIG. 9 is a side elevation of the bottle shown in FIG. 8, the opposite side elevation is a mirror image thereto except for the screw threading on the bottle neck;
FIG. 10 is a top plan view of FIG. 8;
FIG. 11 is a bottom plan view of FIG. 8;
FIG. 12 is a bottom plan view showing one of the bottles of a third embodiment of the interlocking bottle set that differs from the first embodiment only in the contours of the bottom surface; and,
FIG. 13 is a fragmentary bottom perspective view of FIG. 12, the portion of the bottle that is not disclosed is identical to the bottle shown in FIGS. 2 through 7.

(56) **References Cited**

U.S. PATENT DOCUMENTS

D. 86,460	*	3/1932	Keating	D9/522
D. 280,599	*	9/1985	Green	D9/341
D. 282,634	*	2/1986	Beaver et al.	D9/523
D. 325,519		4/1992	Proctor	D9/372
D. 336,846		6/1993	Proctor	D9/300
D. 343,577		1/1994	Proctor	D9/448
D. 373,537	*	9/1996	Sahirado	D9/572
D. 387,673	*	12/1997	Crawford	D9/575
2,013,382	*	9/1935	Garwood	215/6
2,106,464		1/1938	Meyer	215/43
2,134,359		10/1938	Fabrice	215/44

(List continued on next page.)

1 Claim, 7 Drawing Sheets

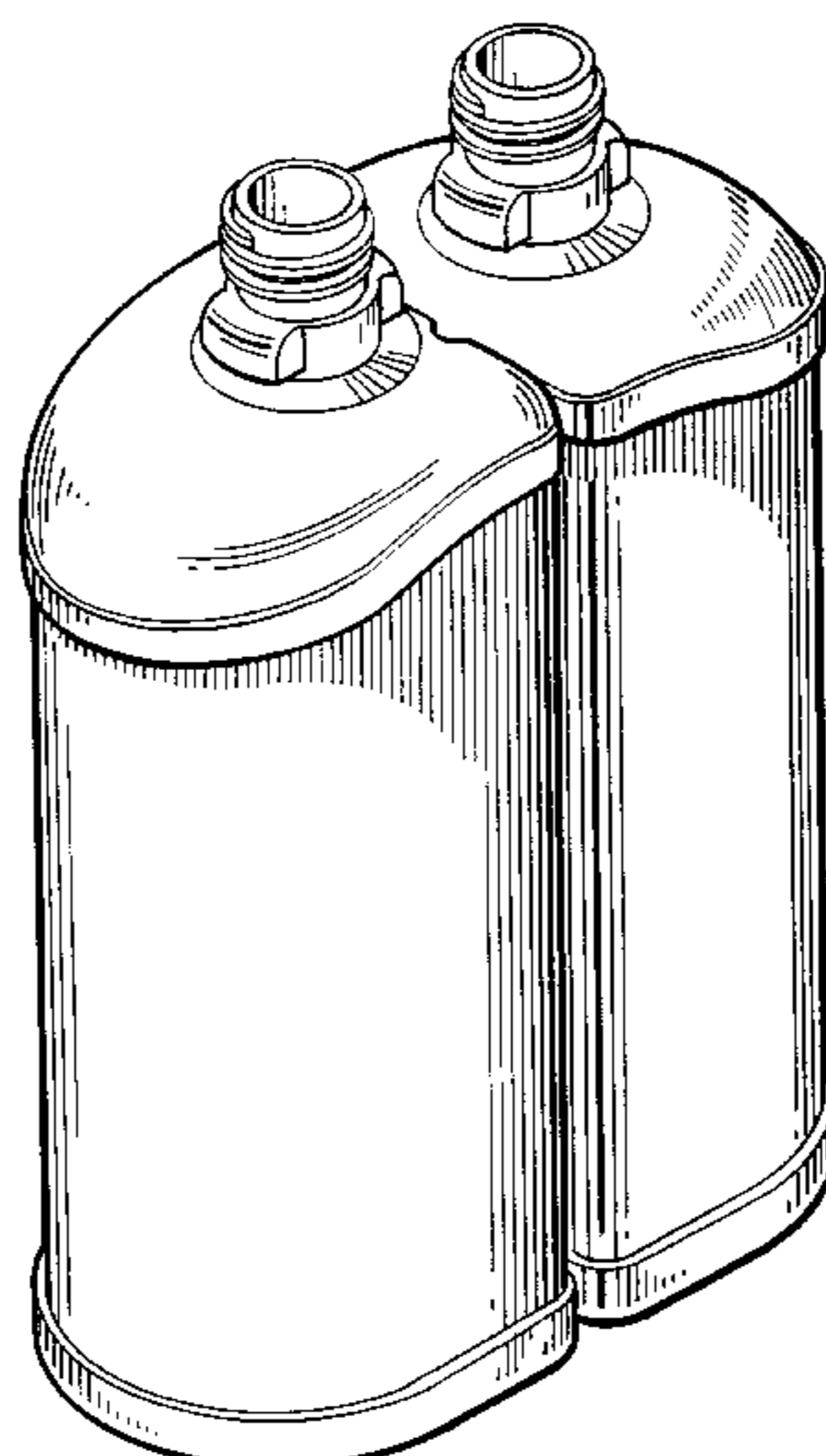

US D439,156 S

Page 2

U.S. PATENT DOCUMENTS							
		5,152,461	10/1992	Proctor	239/304		
2,423,582	* 7/1947	Coleman	215/330	5,316,159	* 5/1994	Douglas et al.	D9/341
3,212,661	* 10/1965	Adell	215/382	5,332,157	7/1994	Proctor	239/304
4,144,983	* 3/1979	Pauls et al.	215/330				
4,196,808	* 4/1980	Pardo	215/6				

* cited by examiner

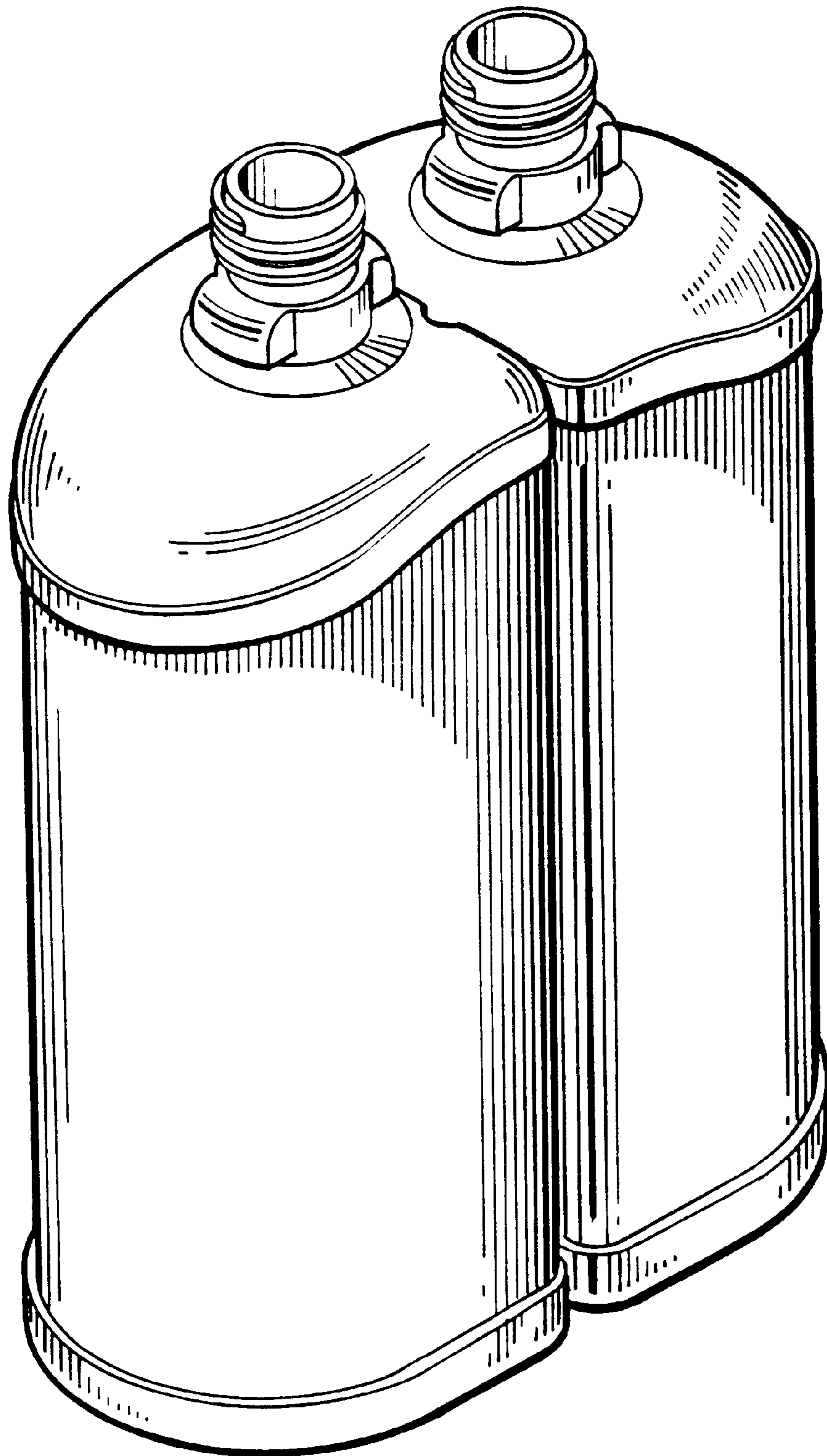

FIG. 1

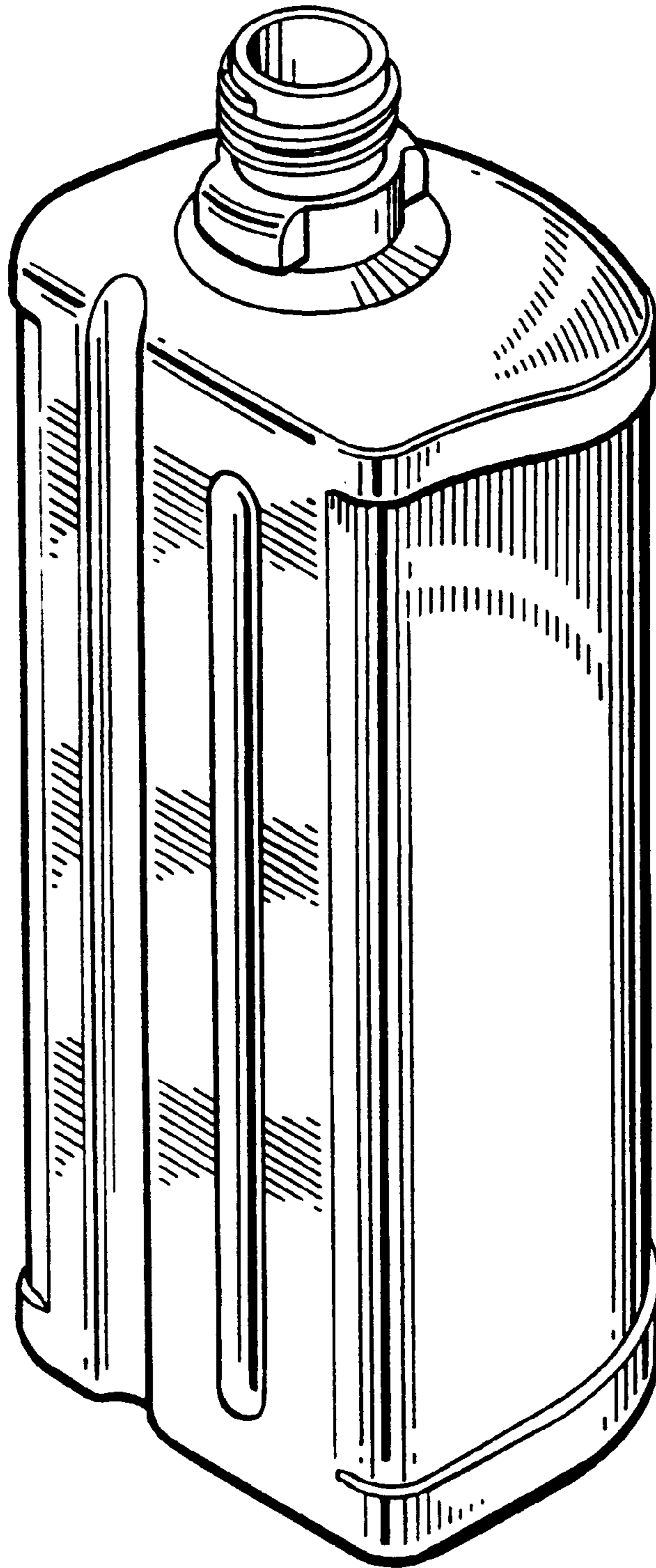

FIG. 2

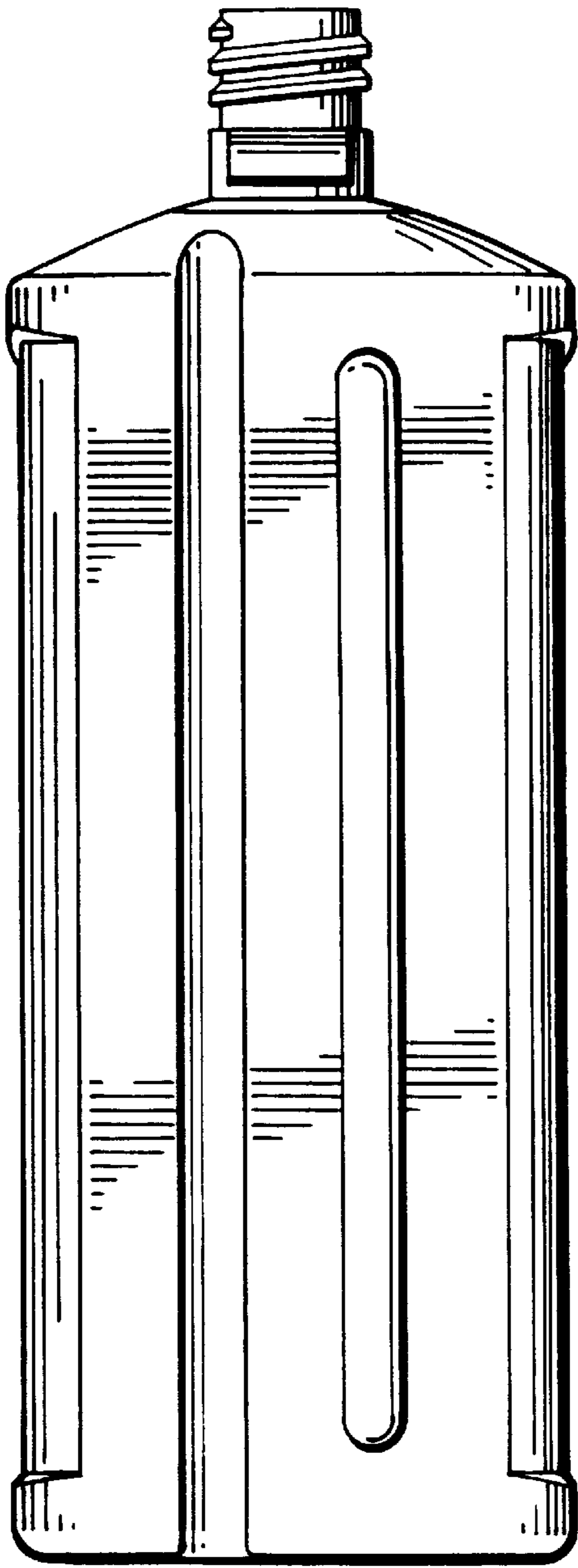

FIG. 3

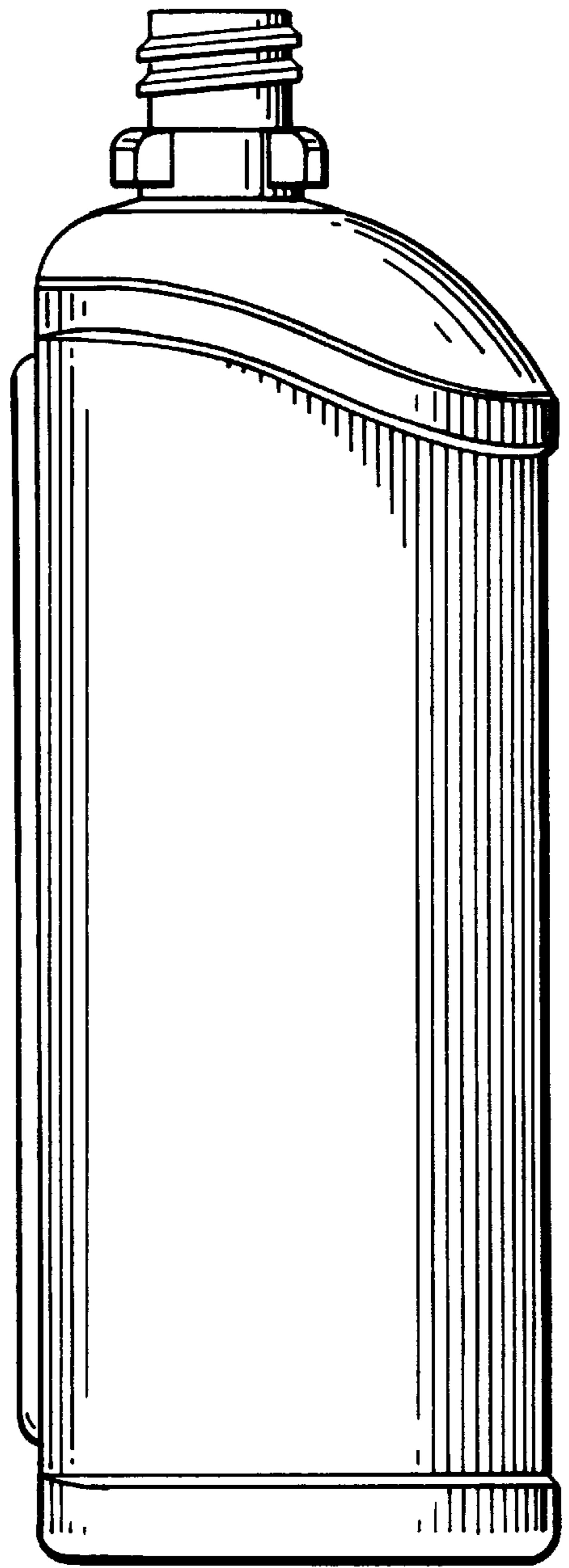

FIG. 4

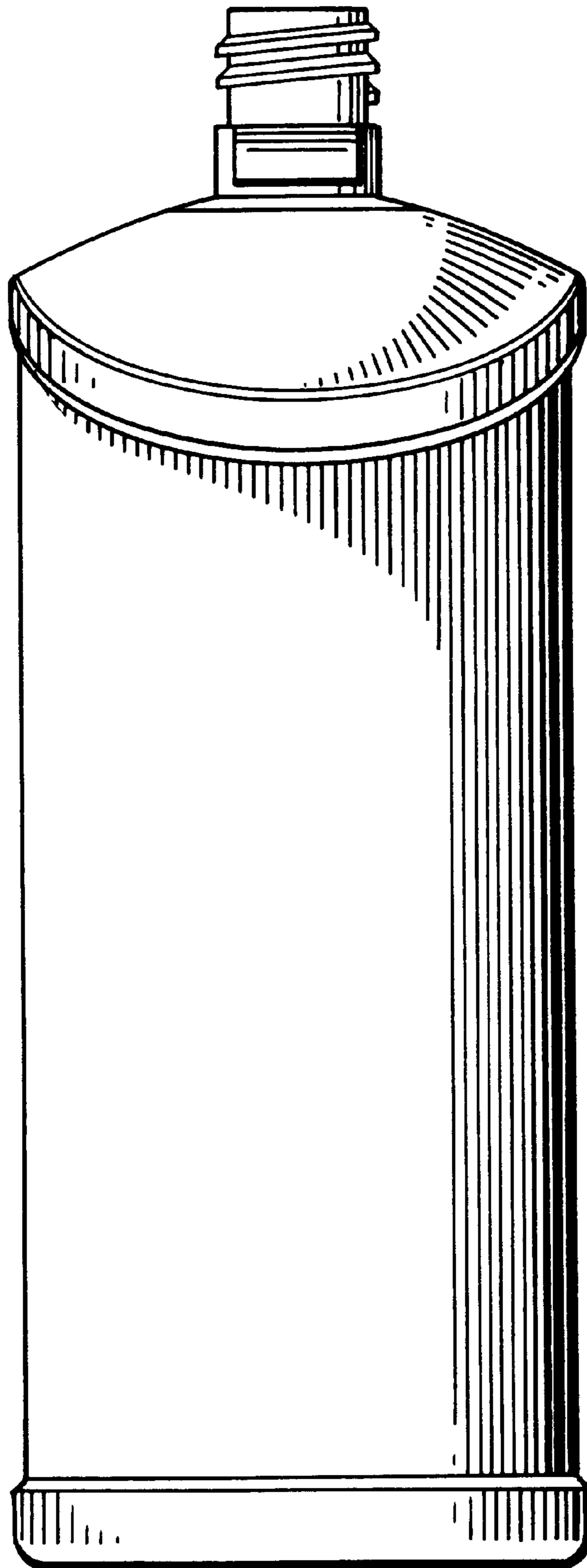

FIG. 5

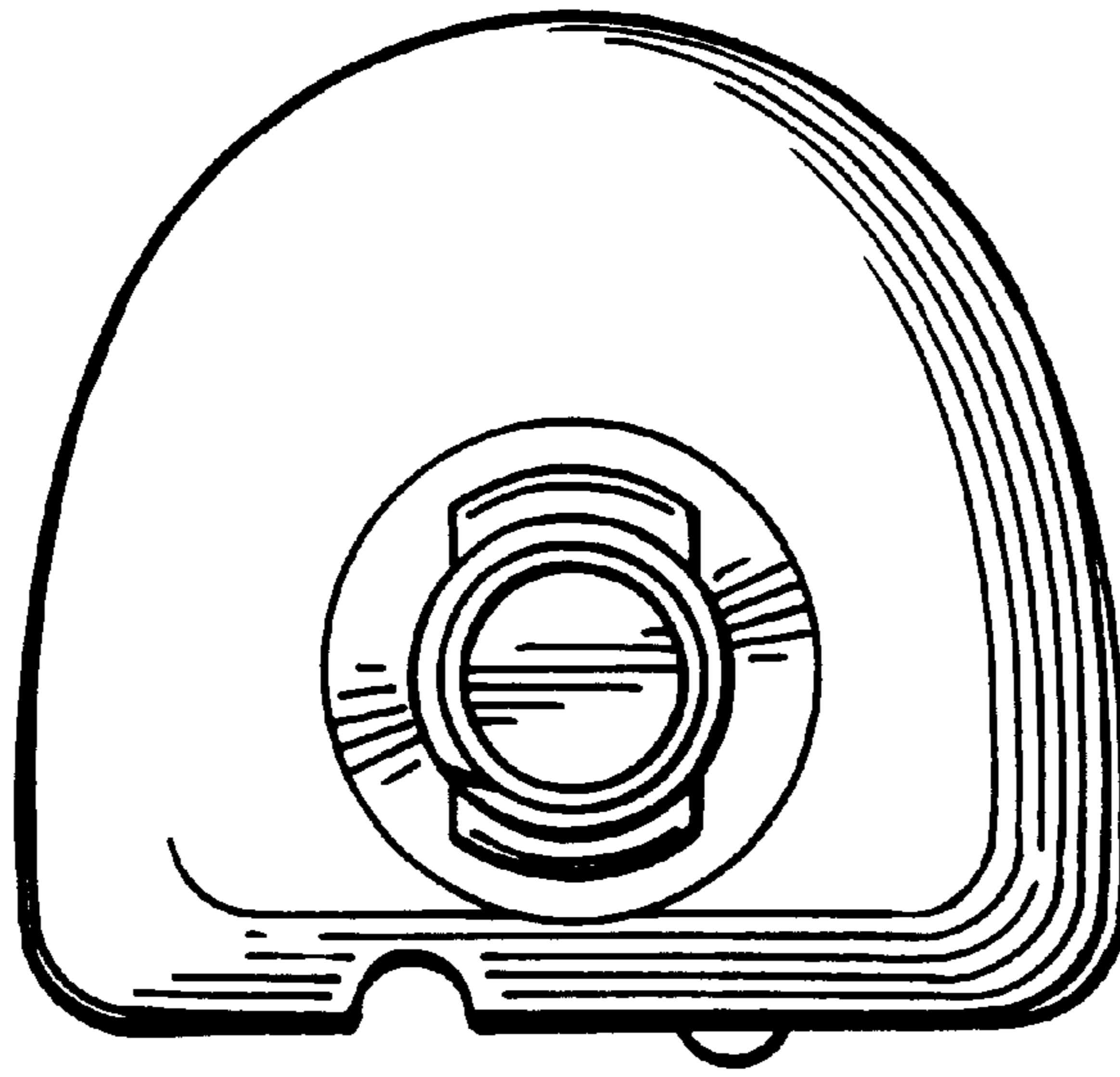

FIG. 6

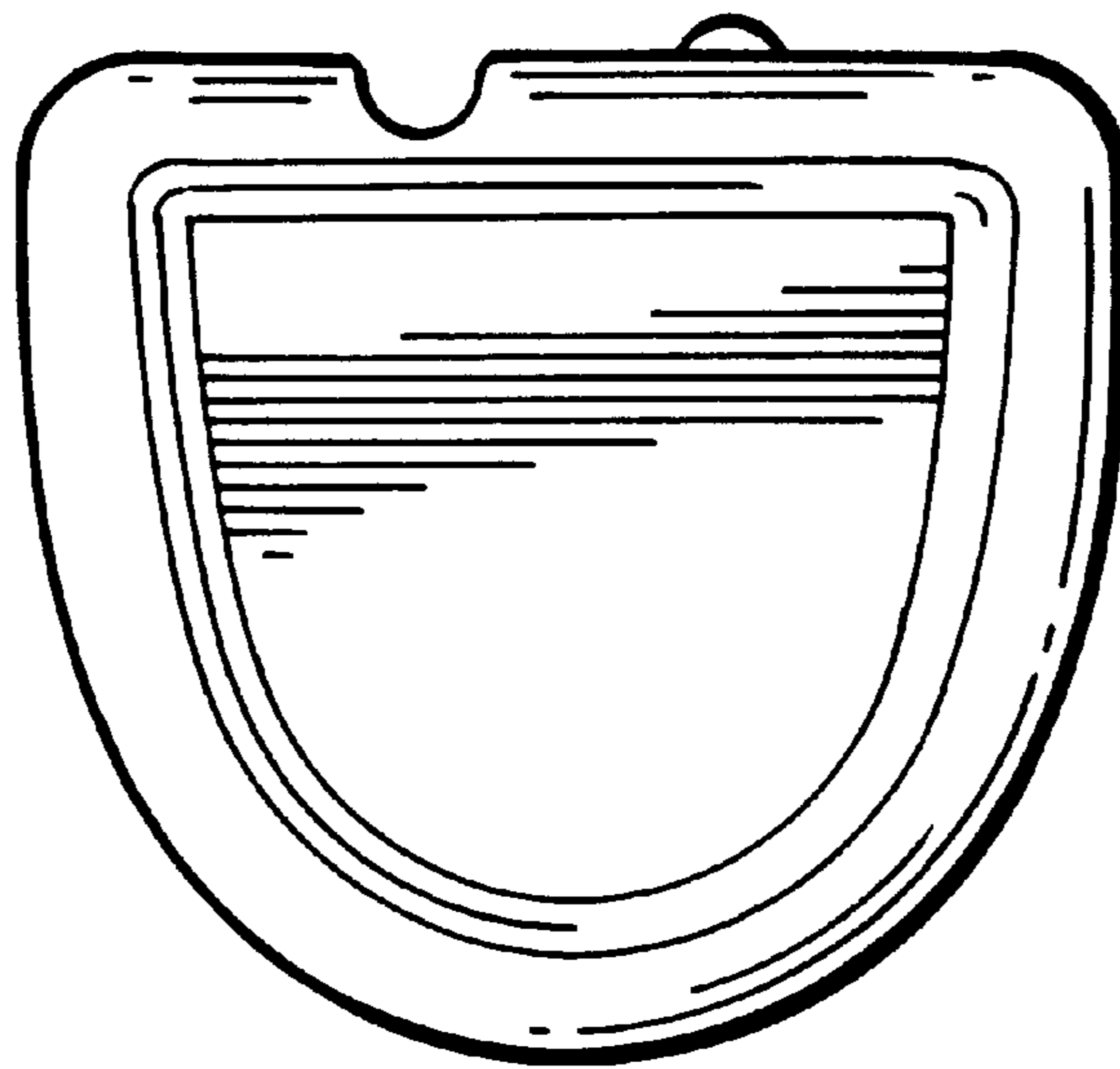

FIG. 7

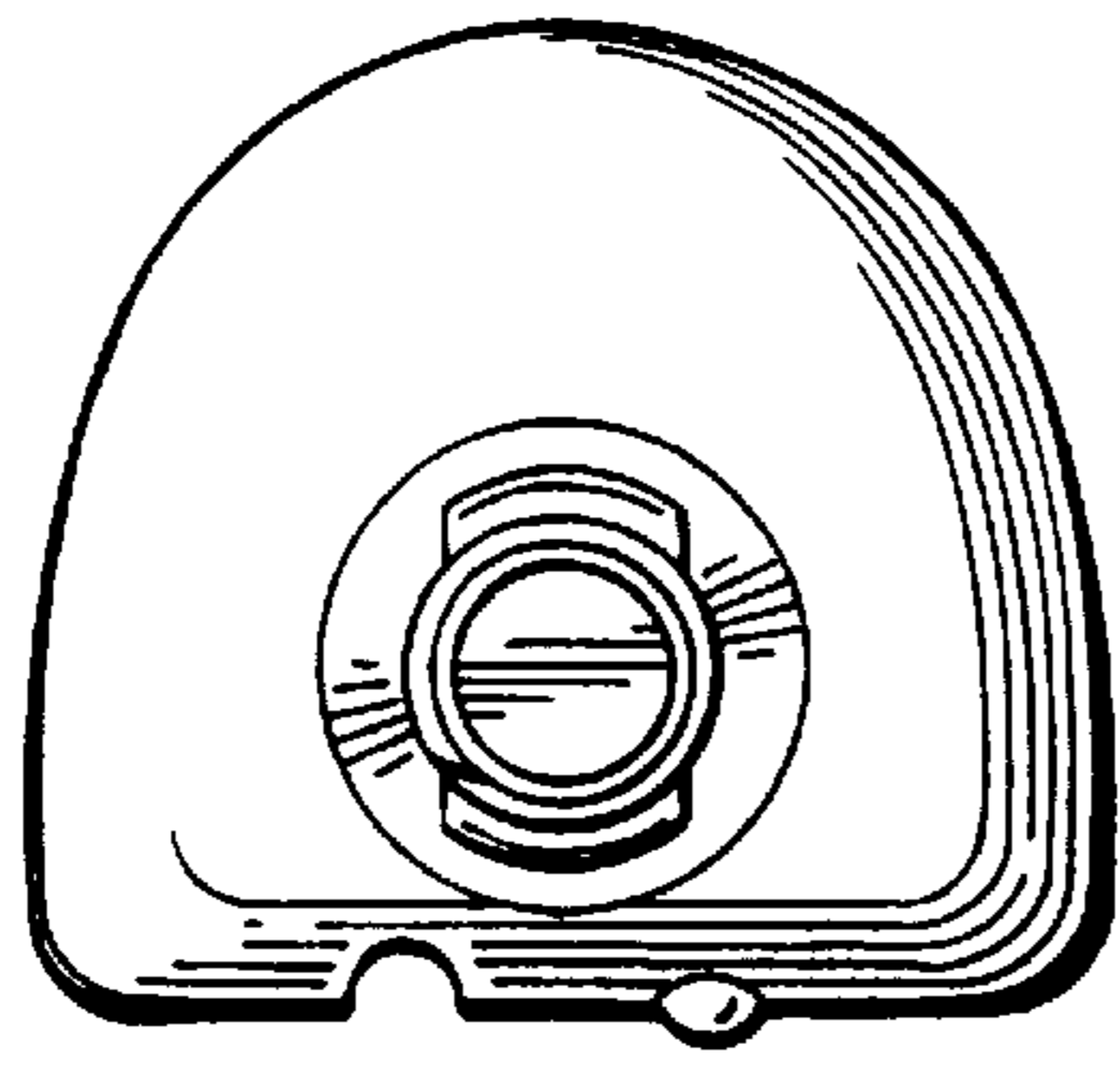

FIG. 10

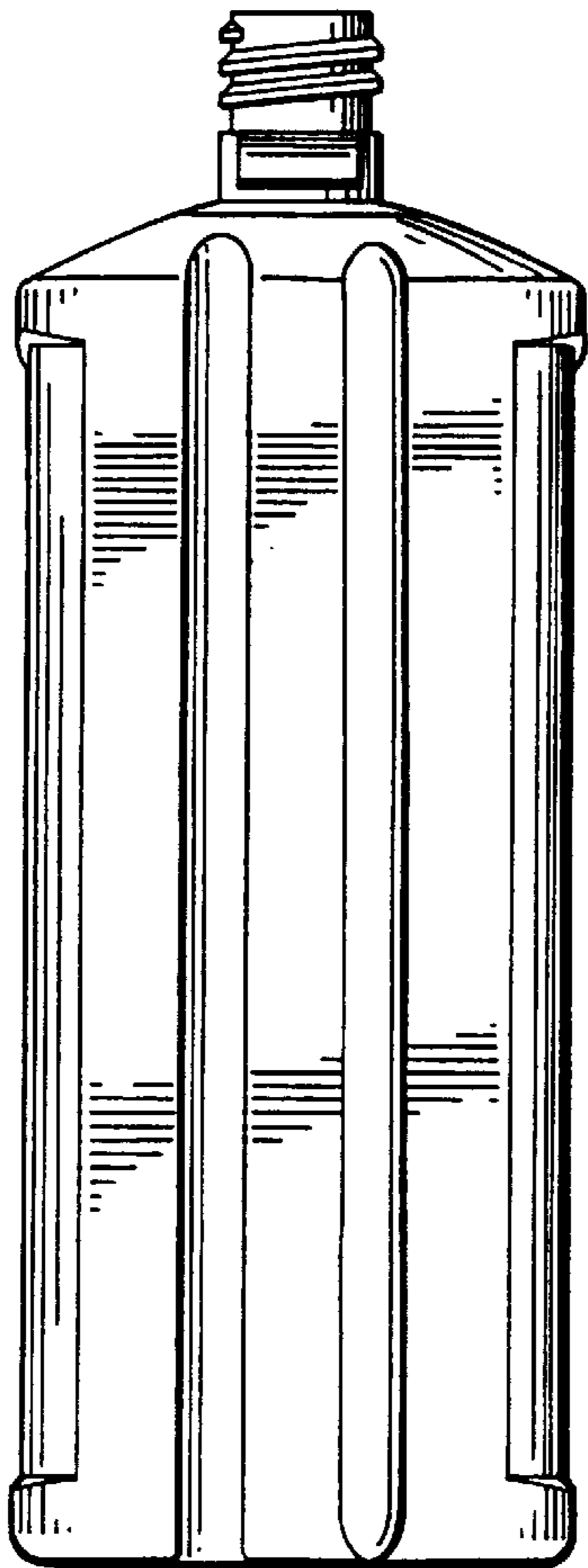

FIG. 8

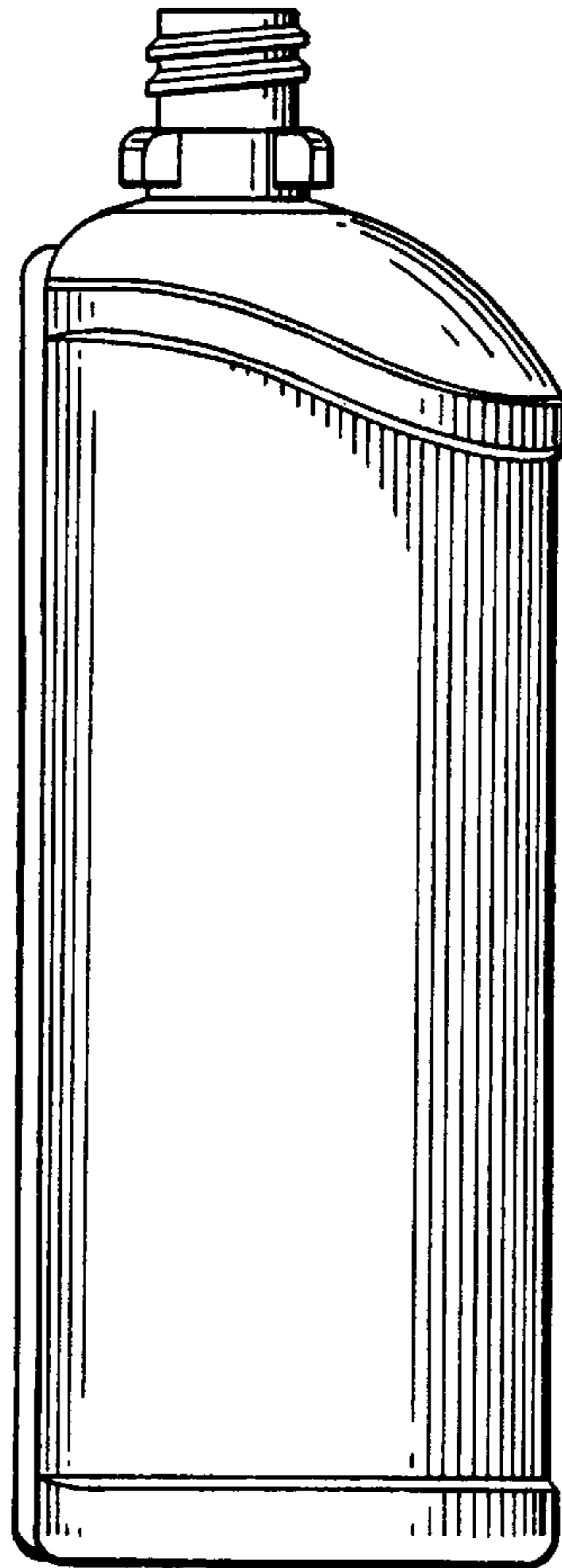

FIG. 9

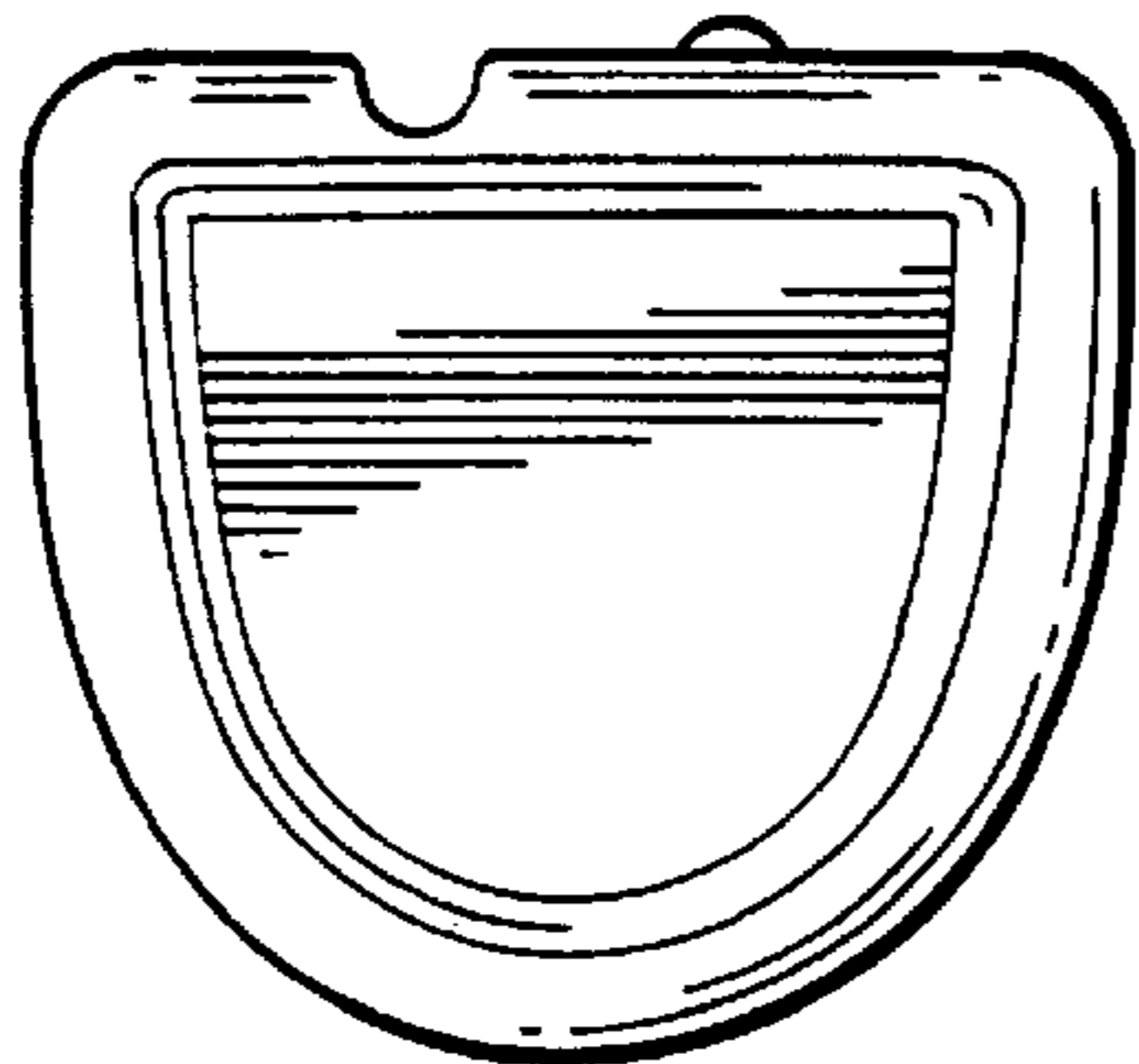

FIG. 11

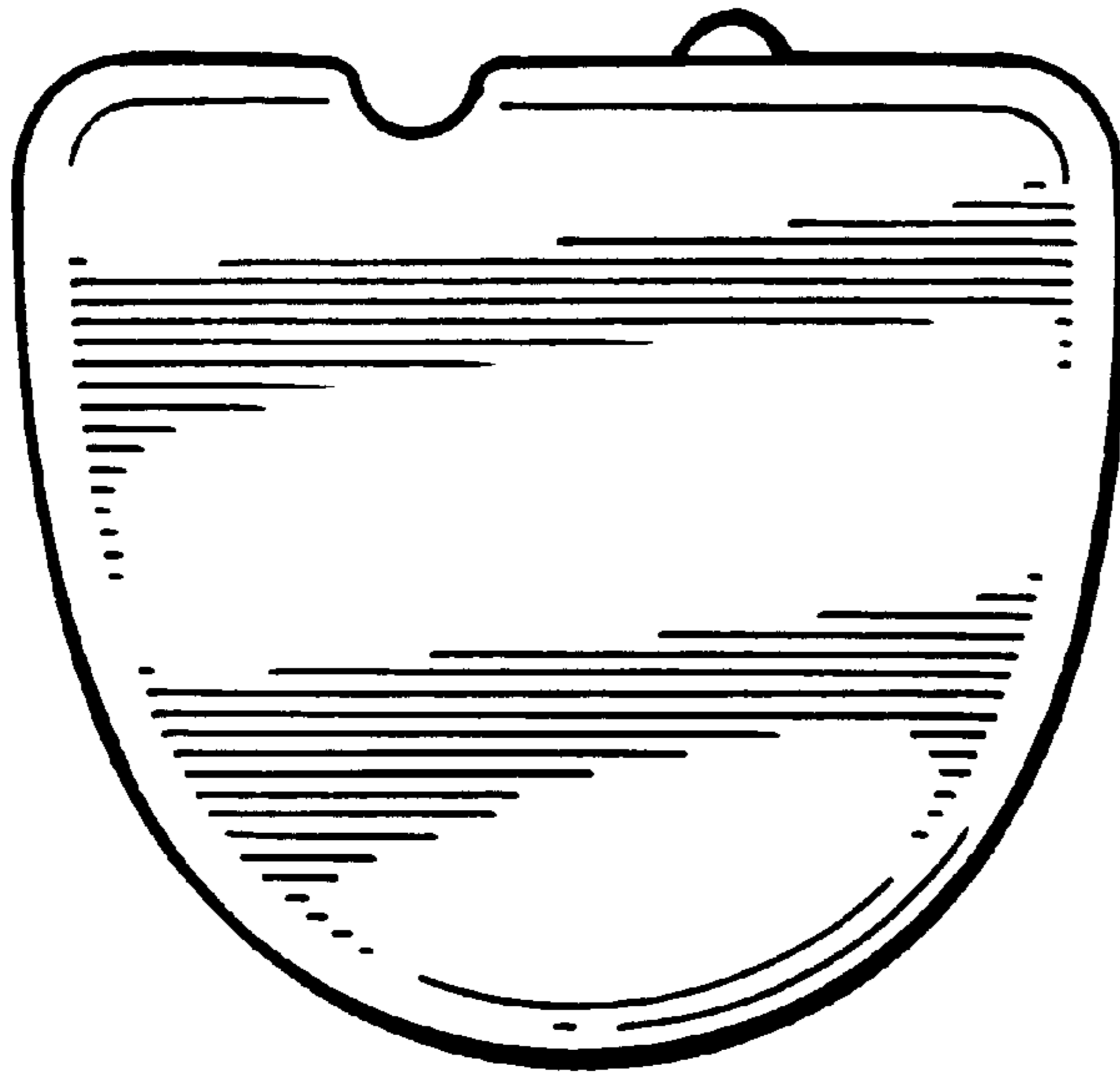

FIG. 12

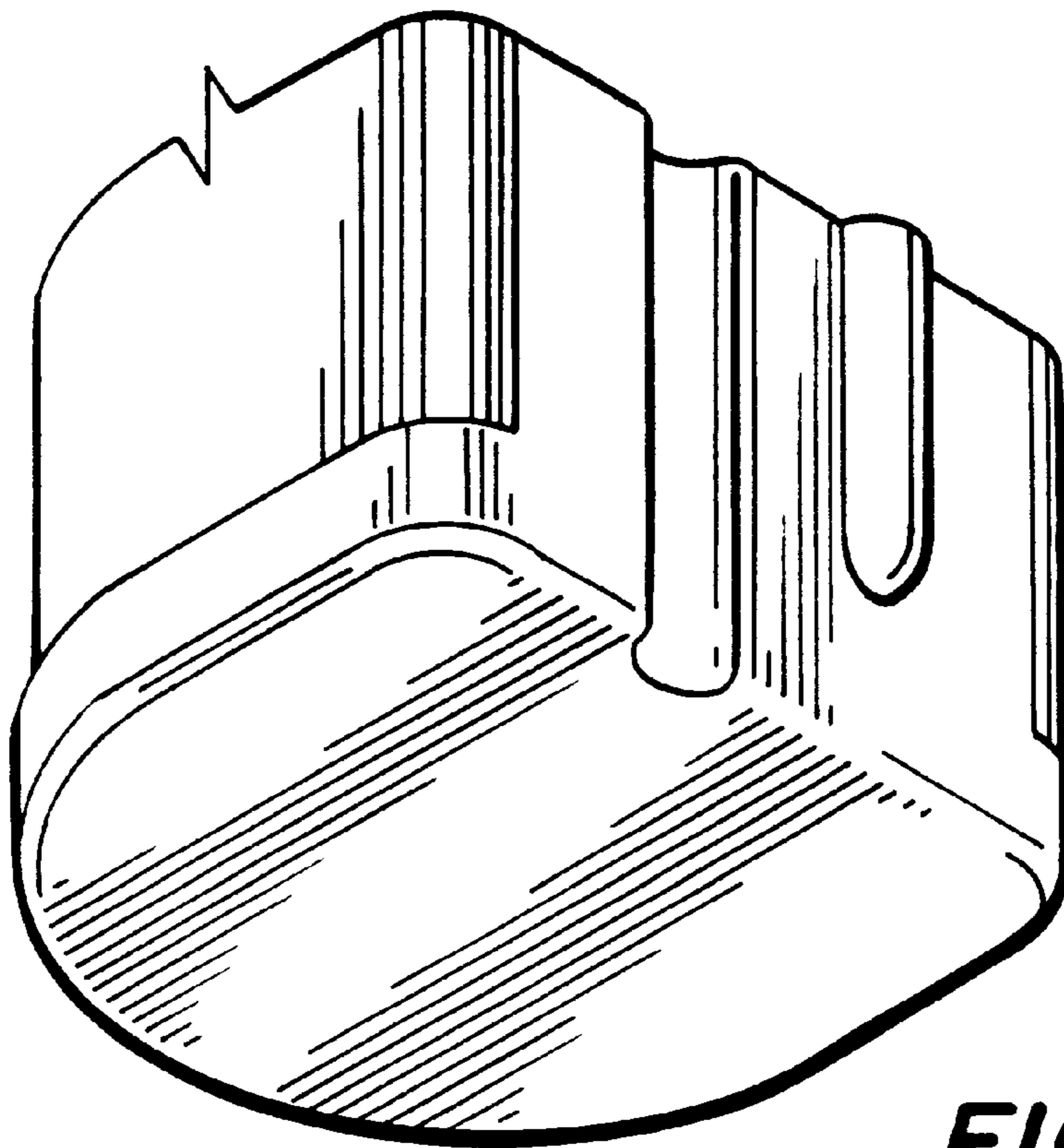

FIG. 13