



US00D439089S

(12) **United States Design Patent**
Goodman et al.

(10) **Patent No.:** **US D439,089 S**

(45) **Date of Patent:** **** Mar. 20, 2001**

(54) **TOWEL RING**

4,907,771 * 3/1990 Wang D6/546 X

(75) Inventors: **Sheldon H. Goodman**, 30905 Stratford,
Solon, OH (US) 44139; **Brian**
Stelmarski, Mayfield Heights, OH (US)

* cited by examiner

Primary Examiner—Brian N. Vinson

(74) *Attorney, Agent, or Firm*—Pearne & Gordon LLP

(73) Assignee: **Sheldon H. Goodman**, Solon, OH (US)

(57) **CLAIM**

(**) Term: **14 Years**

The ornamental design for a towel ring, as shown and described.

(21) Appl. No.: **29/122,144**

DESCRIPTION

(22) Filed: **Apr. 19, 2000**

(51) **LOC (7) Cl.** **06-04**

(52) **U.S. Cl.** **D6/546**

(58) **Field of Search** D6/546–550, 522–523;
242/590, 596, 597–598; 211/13.1, 32, 35,
87.01, 88.04, 105.1, 105.2, 106, 123, 181.1,
182; 248/49, 214, 251, 302

FIG. 1 is a top, front and side perspective view of a towel ring showing our new design;
FIG. 2 is a front elevational view thereof;
FIG. 3 is a rear elevational view thereof;
FIG. 4 is a right side elevational view thereof;
FIG. 5 is a left side elevational view thereof;
FIG. 6 is a top plan view thereof; and,
FIG. 7 is a bottom plan view thereof.

The broken-line disclosure of elements in the views is for illustrative purposes only and forms no part of the claimed design.

(56) **References Cited**

U.S. PATENT DOCUMENTS

- D. 362,615 * 9/1995 Shames et al. D6/546 X
- D. 425,741 * 5/2000 Duggan D6/523

1 Claim, 1 Drawing Sheet

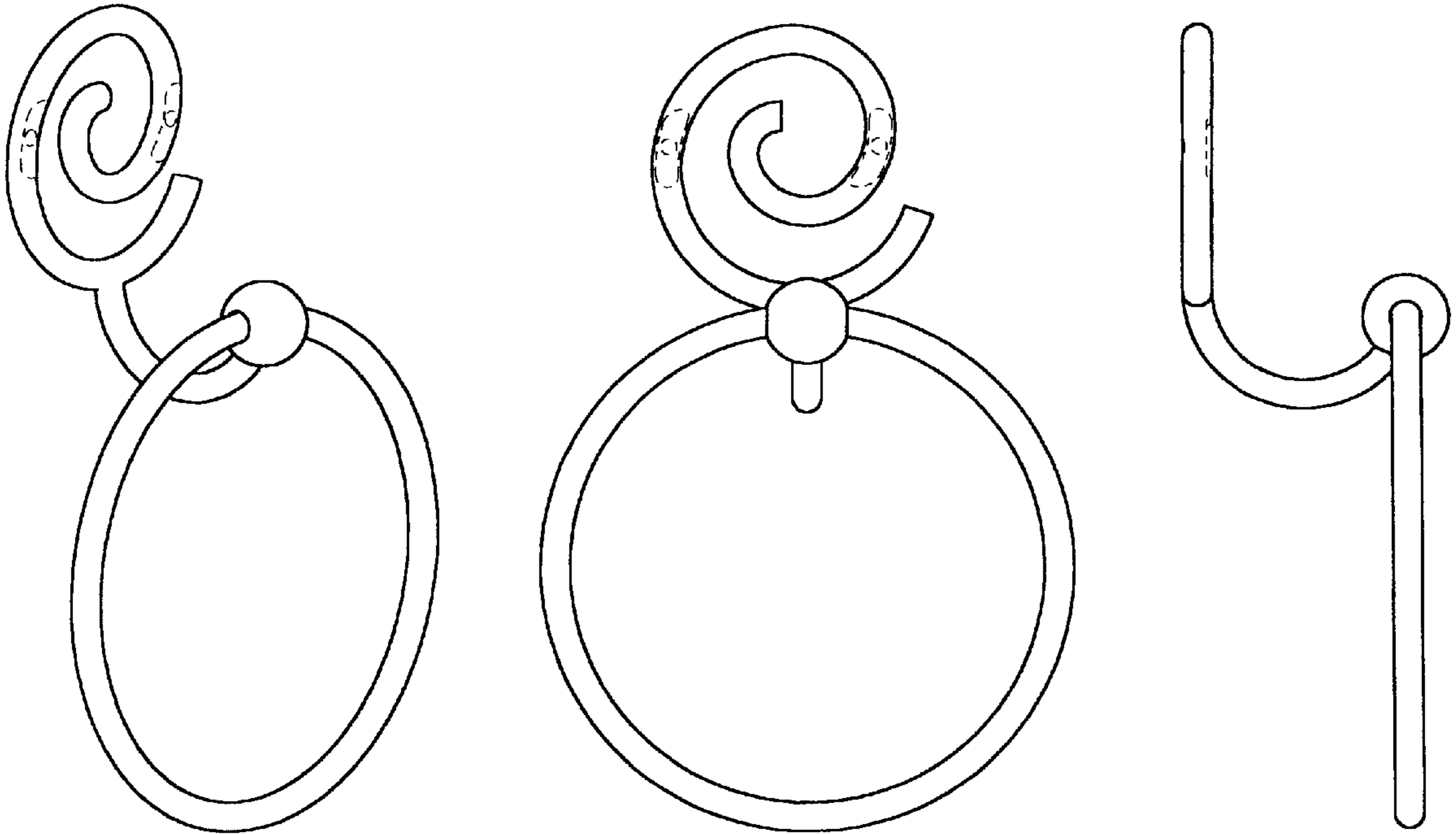

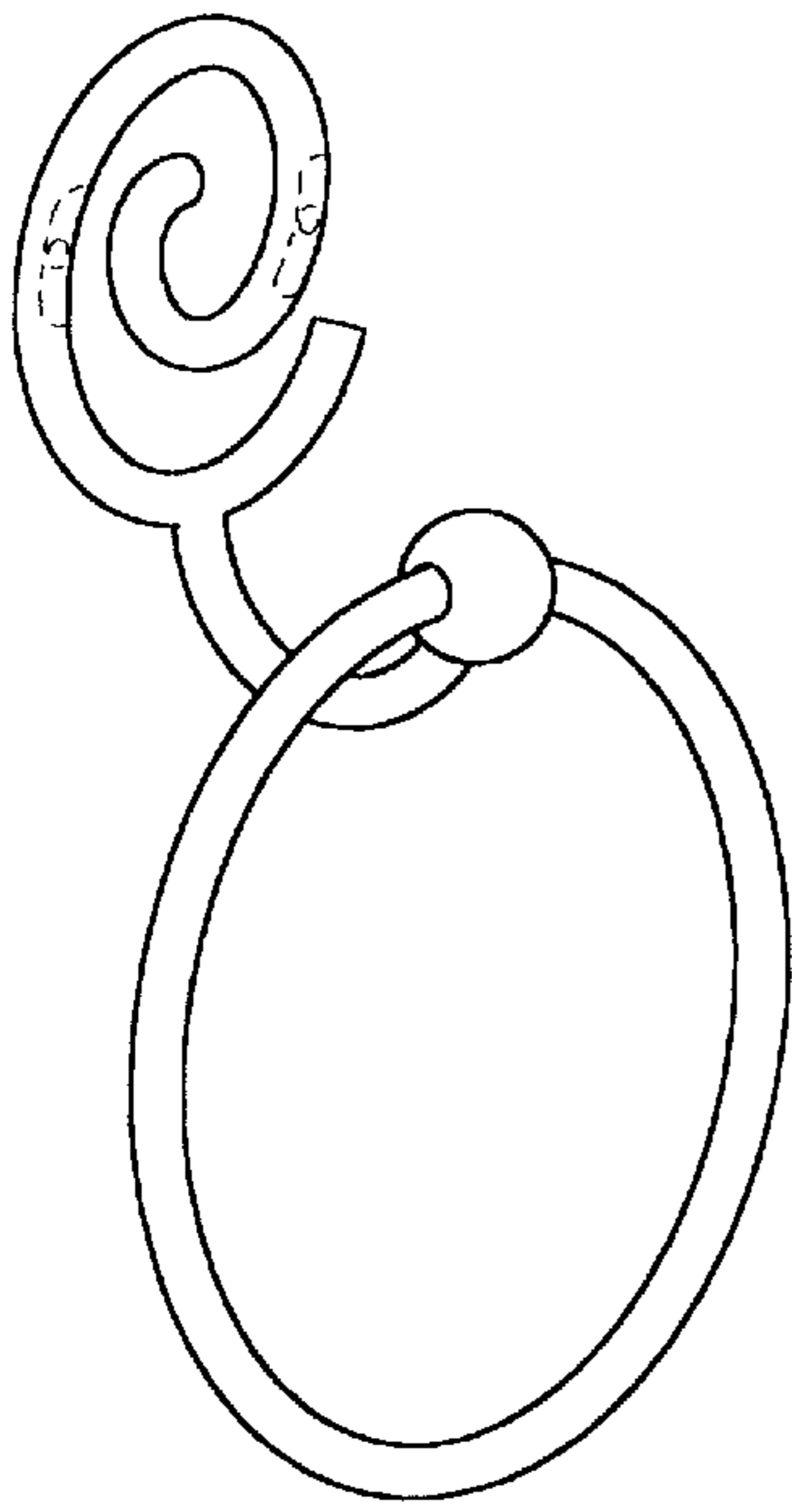

Fig.1

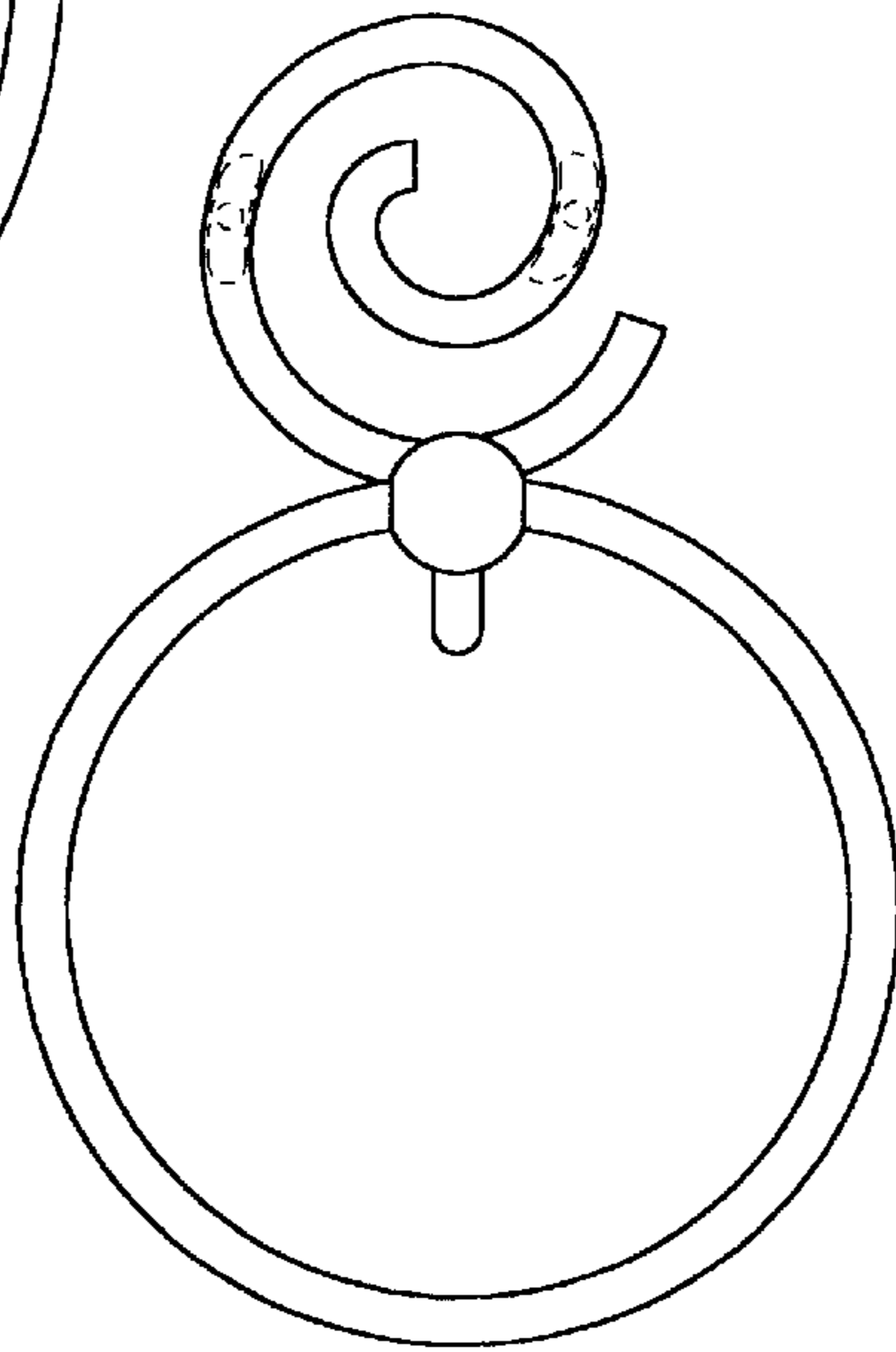

Fig.2

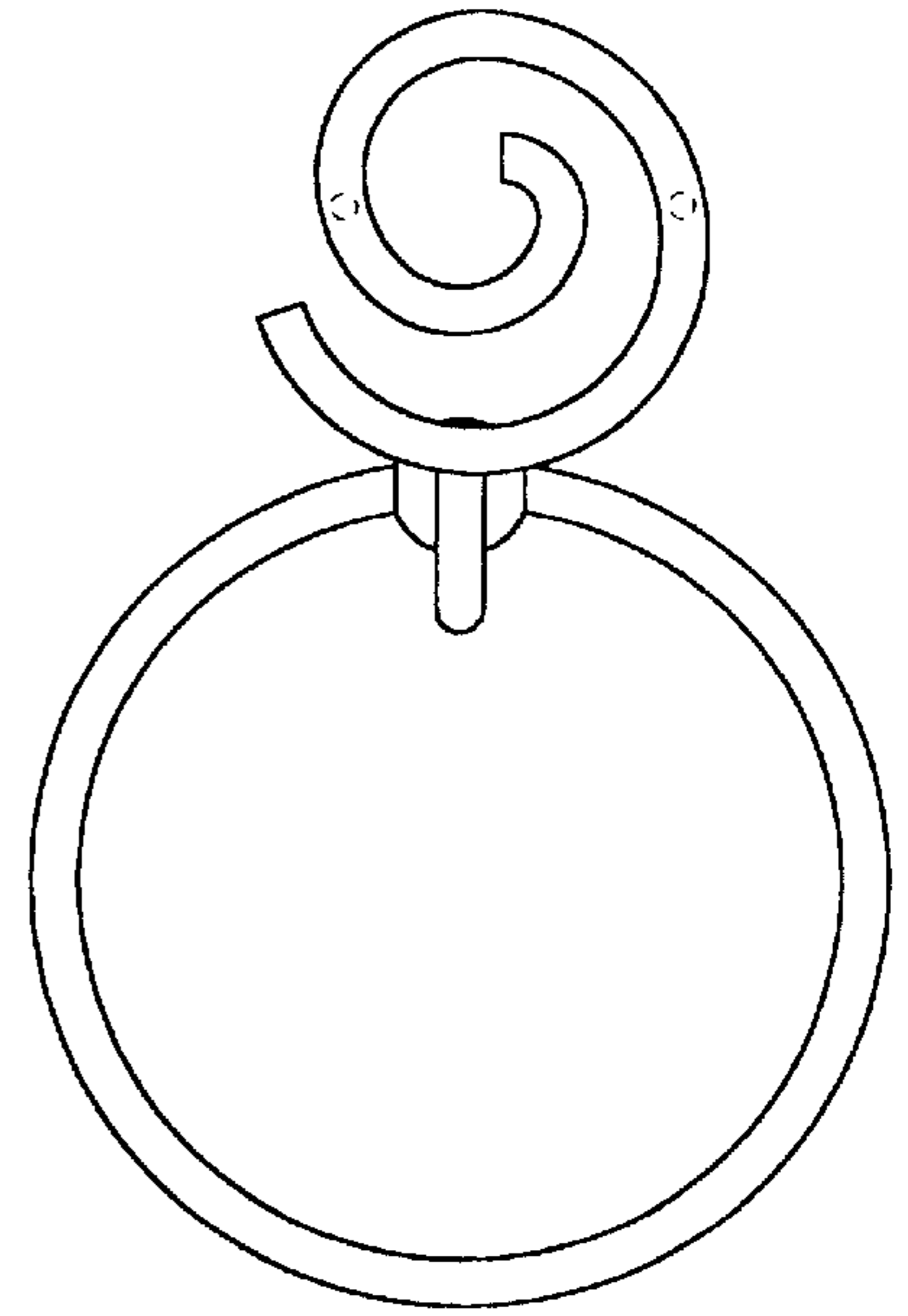

Fig.3

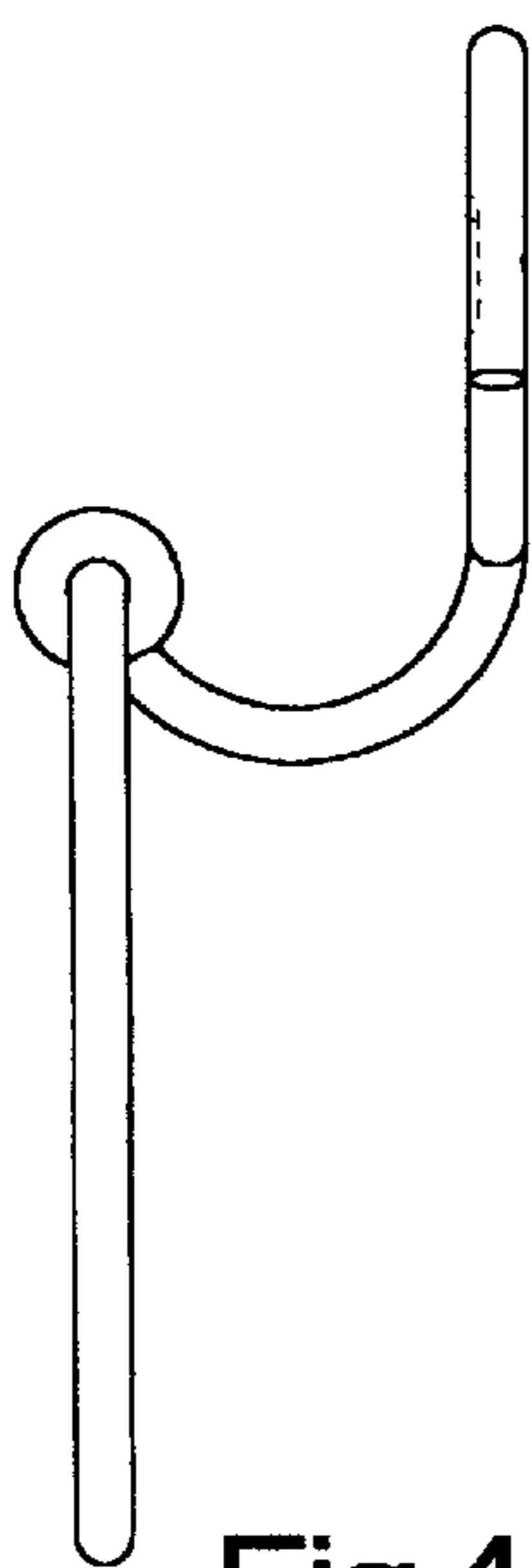

Fig.4

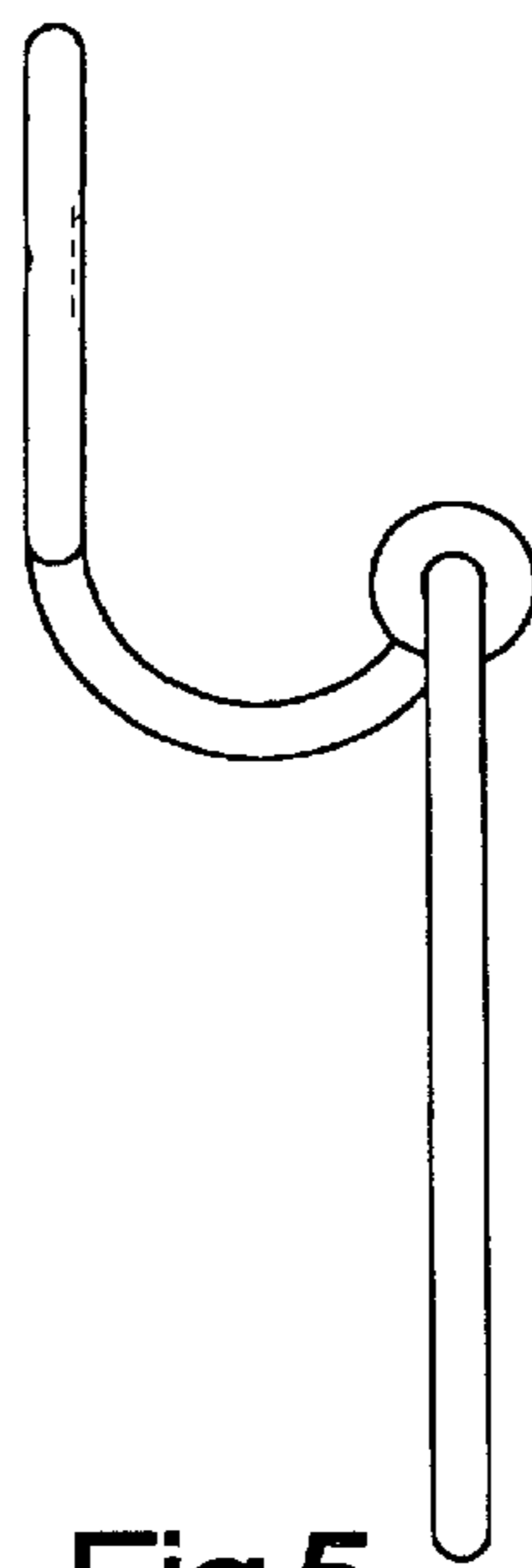

Fig.5

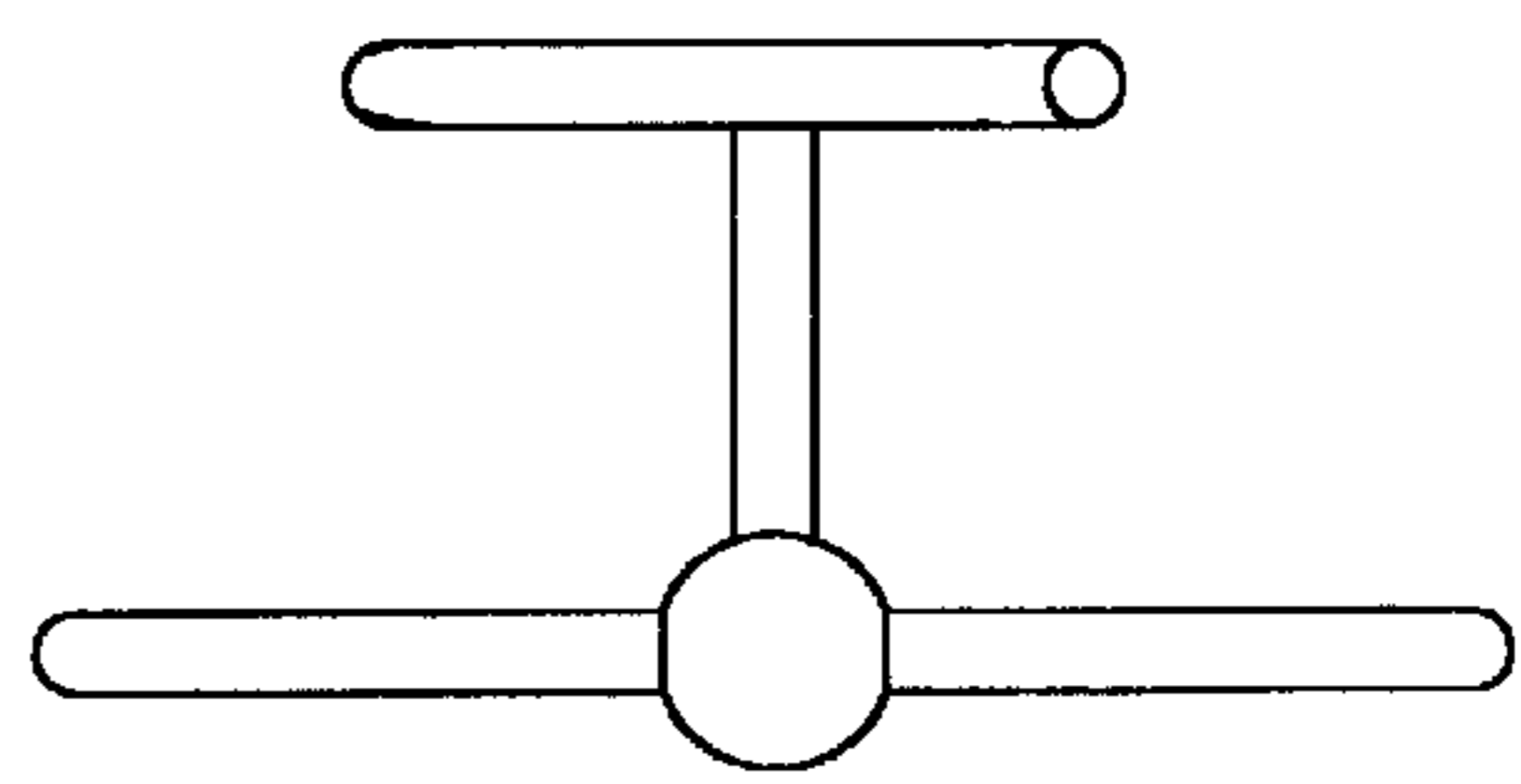

Fig.6

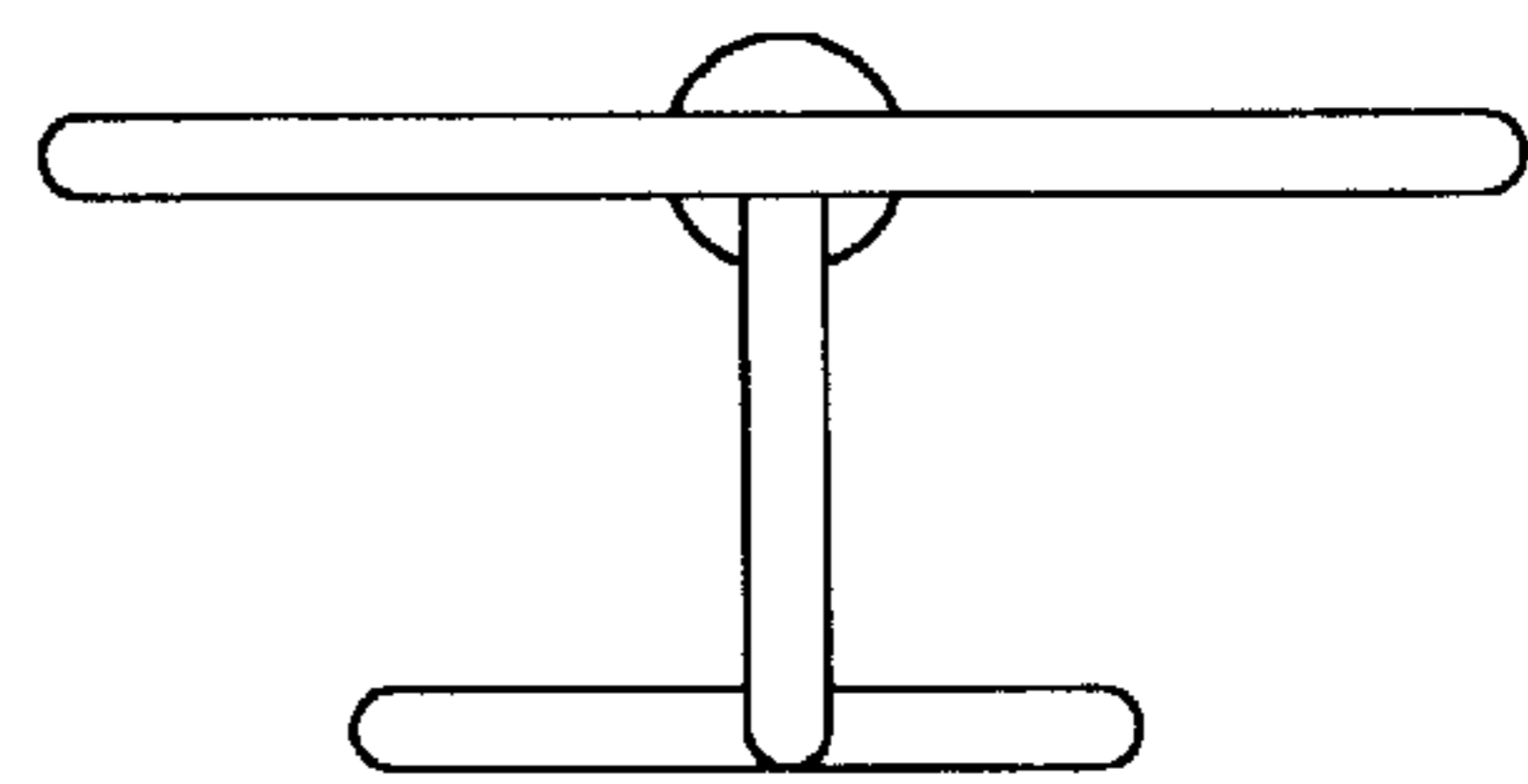

Fig.7