



US00D438928S

(12) **United States Design Patent**
Yates et al.

(10) **Patent No.:** **US D438,928 S**

(45) **Date of Patent:** **** Mar. 13, 2001**

(54) **ROOF CAP FOR PLAYGROUND DECK**

(75) Inventors: **Michael Yates**, Fort Payne; **Brandon McBride**, Langton, both of AL (US)

(73) Assignee: **Playcore, Inc.**, Janesville, WI (US)

(**) Term: **14 Years**

(21) Appl. No.: **29/115,492**

(22) Filed: **Dec. 15, 1999**

(51) **LOC (7) Cl.** **21-03**

(52) **U.S. Cl.** **D21/814**

(58) **Field of Search** D21/811, 814,
D21/818, 821, 823, 826, 827; 482/35, 36

(56) **References Cited**

U.S. PATENT DOCUMENTS

- D. 351,208 * 10/1994 Delaney et al. D21/811
- D. 419,633 * 1/2000 Sutton et al. D21/826

* cited by examiner

Primary Examiner—Mitchell Siegel

(74) *Attorney, Agent, or Firm*—Welsh & Katz, Ltd.

(57) **CLAIM**

The ornamental design for a roof cap for playground deck, as shown and described.

DESCRIPTION

FIG. 1 is a perspective view of the roof cap for playground deck, shown used on a suggested platform.

FIG. 2 is a front view of the roof cap for playground deck of FIG. 1.

FIG. 3 is a rear view of the roof cap for playground deck of FIG. 1.

FIG. 4 is a right side view of the roof cap for playground deck of FIG. 1.

FIG. 5 is a left side view of the roof cap for playground deck of FIG. 1;

FIG. 6 is a top view of the roof cap for playground deck of FIG. 1; and,

FIG. 7 is a bottom view of the roof cap for playground deck of FIG. 1.

1 Claim, 4 Drawing Sheets

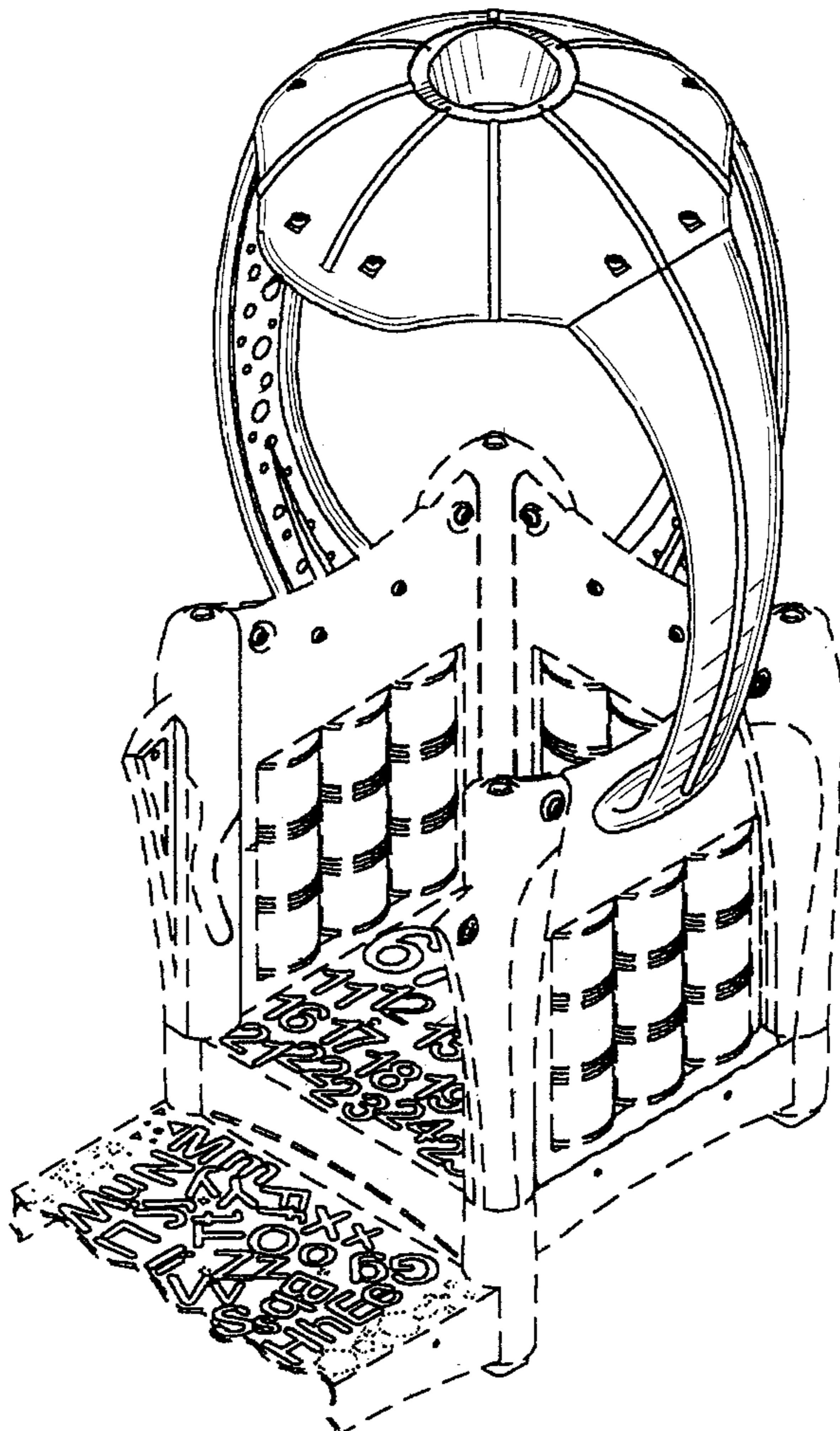

FIG. 1

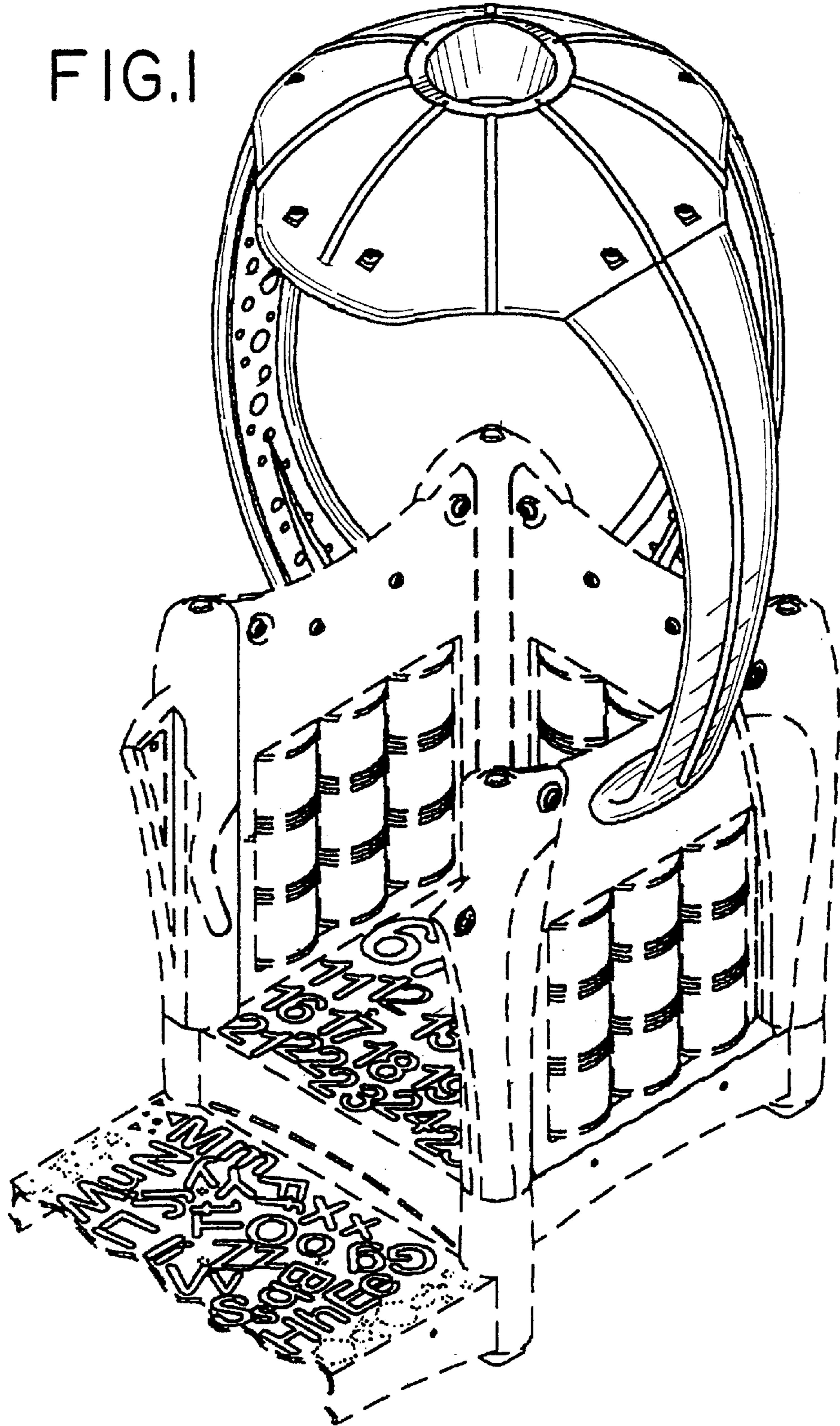

FIG.3

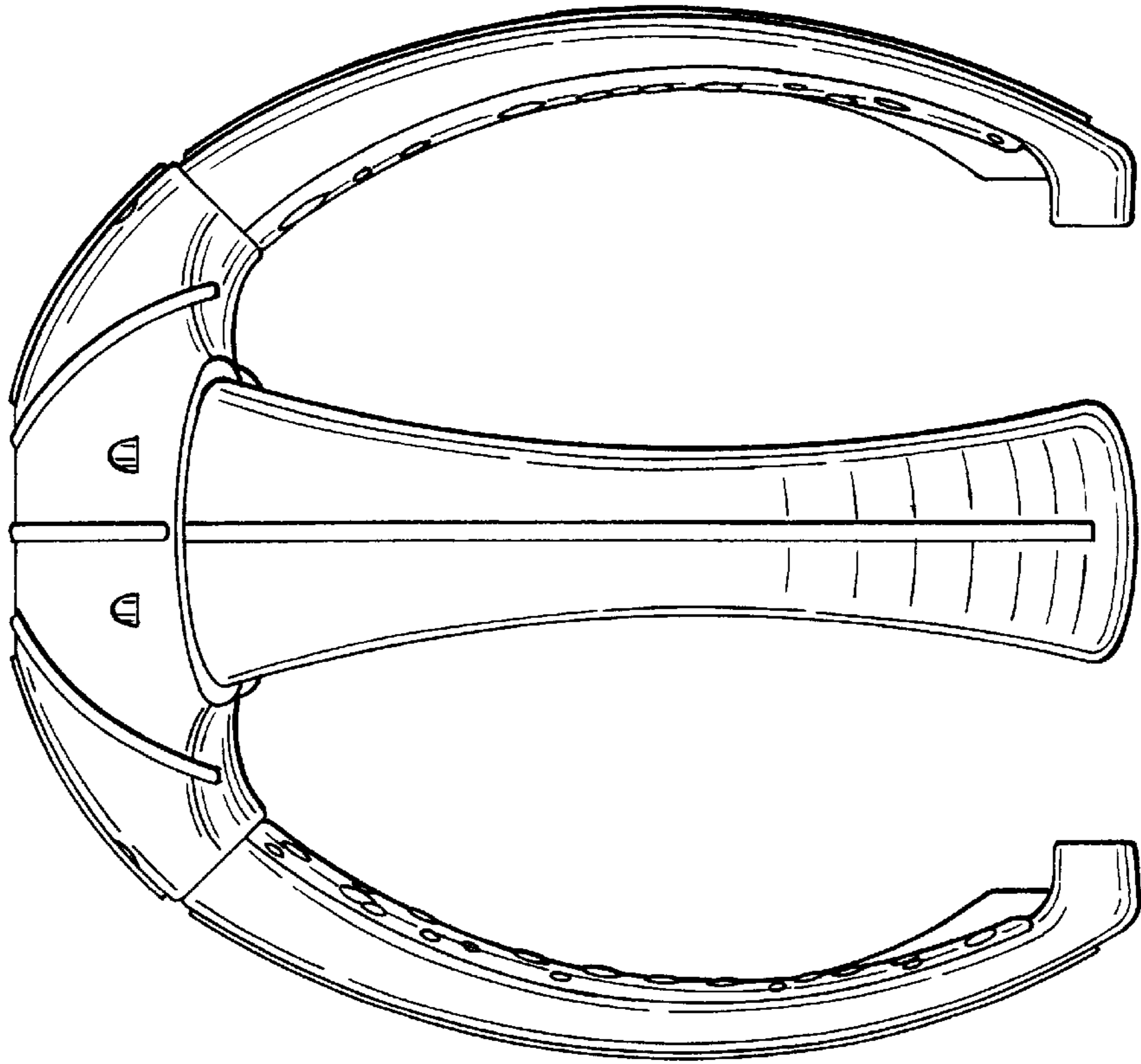

FIG.2

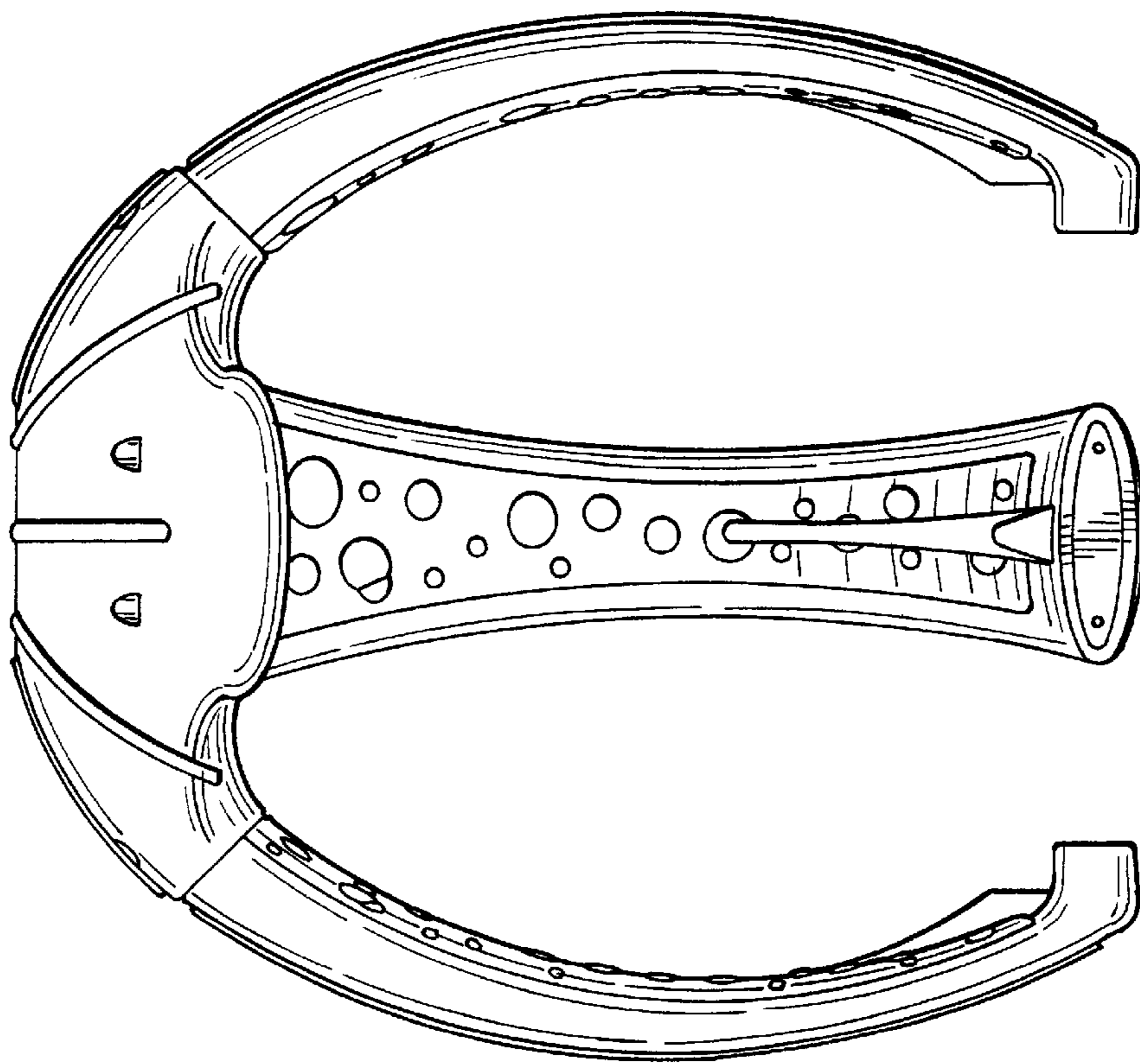

FIG.5

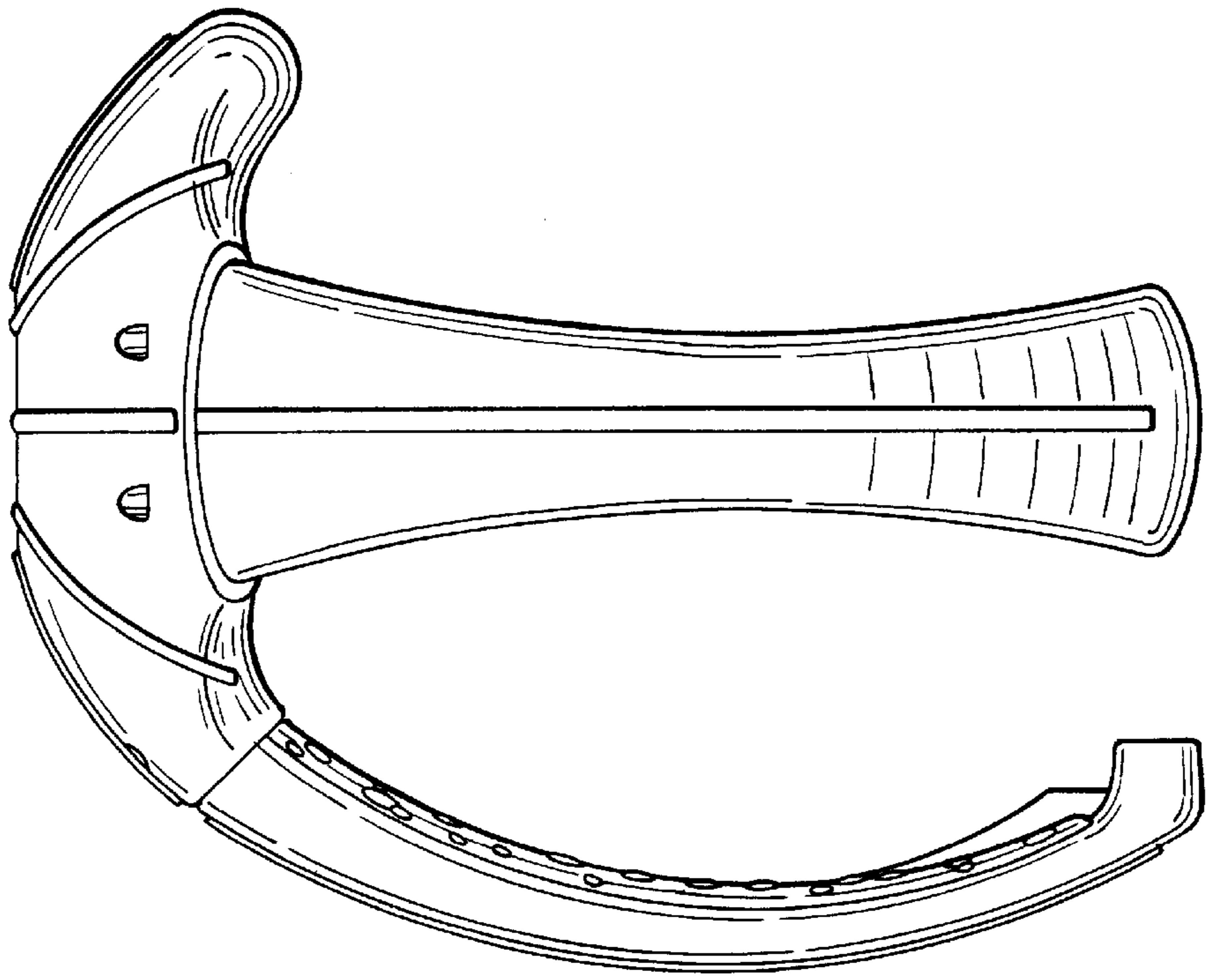

FIG.4

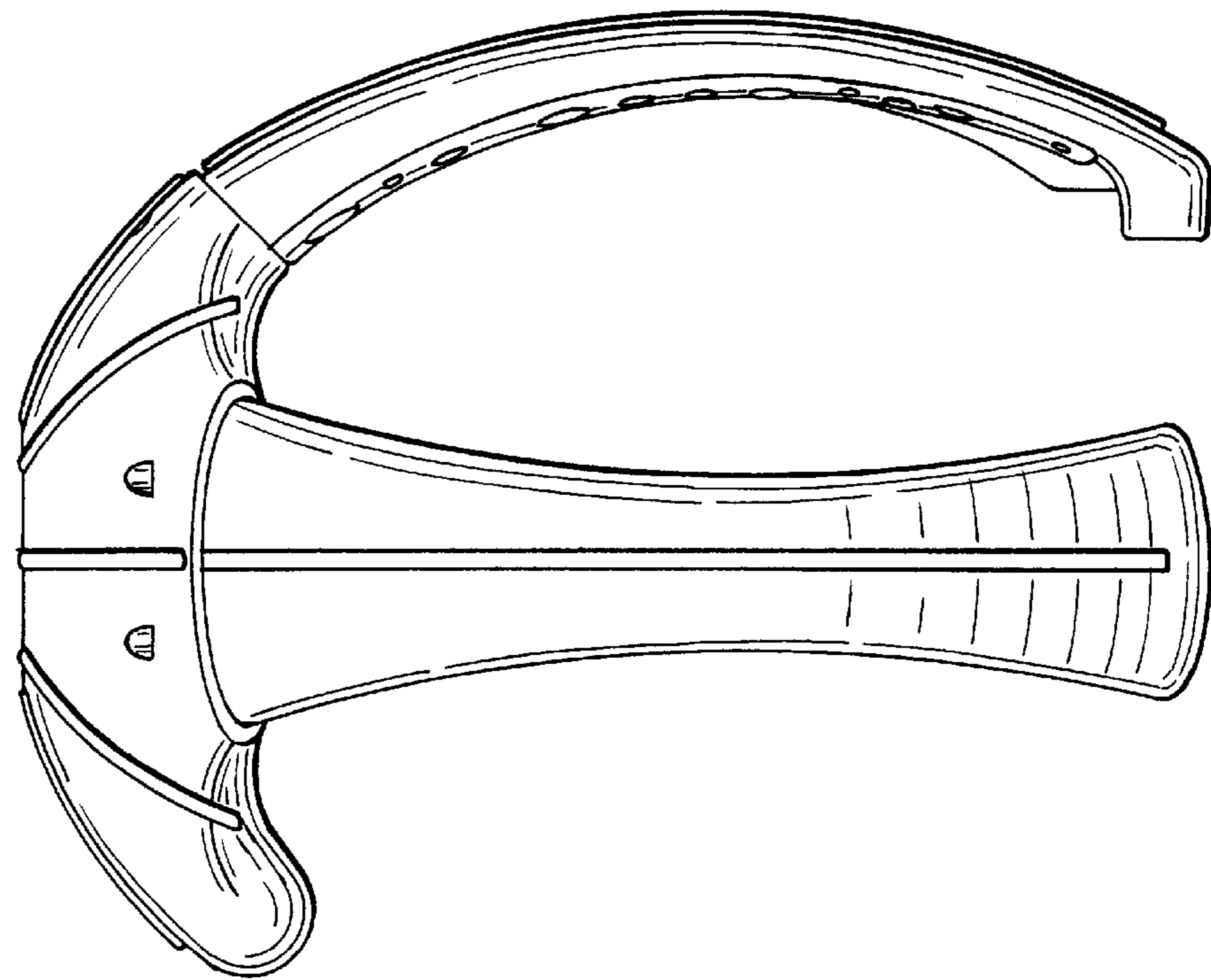

FIG.6

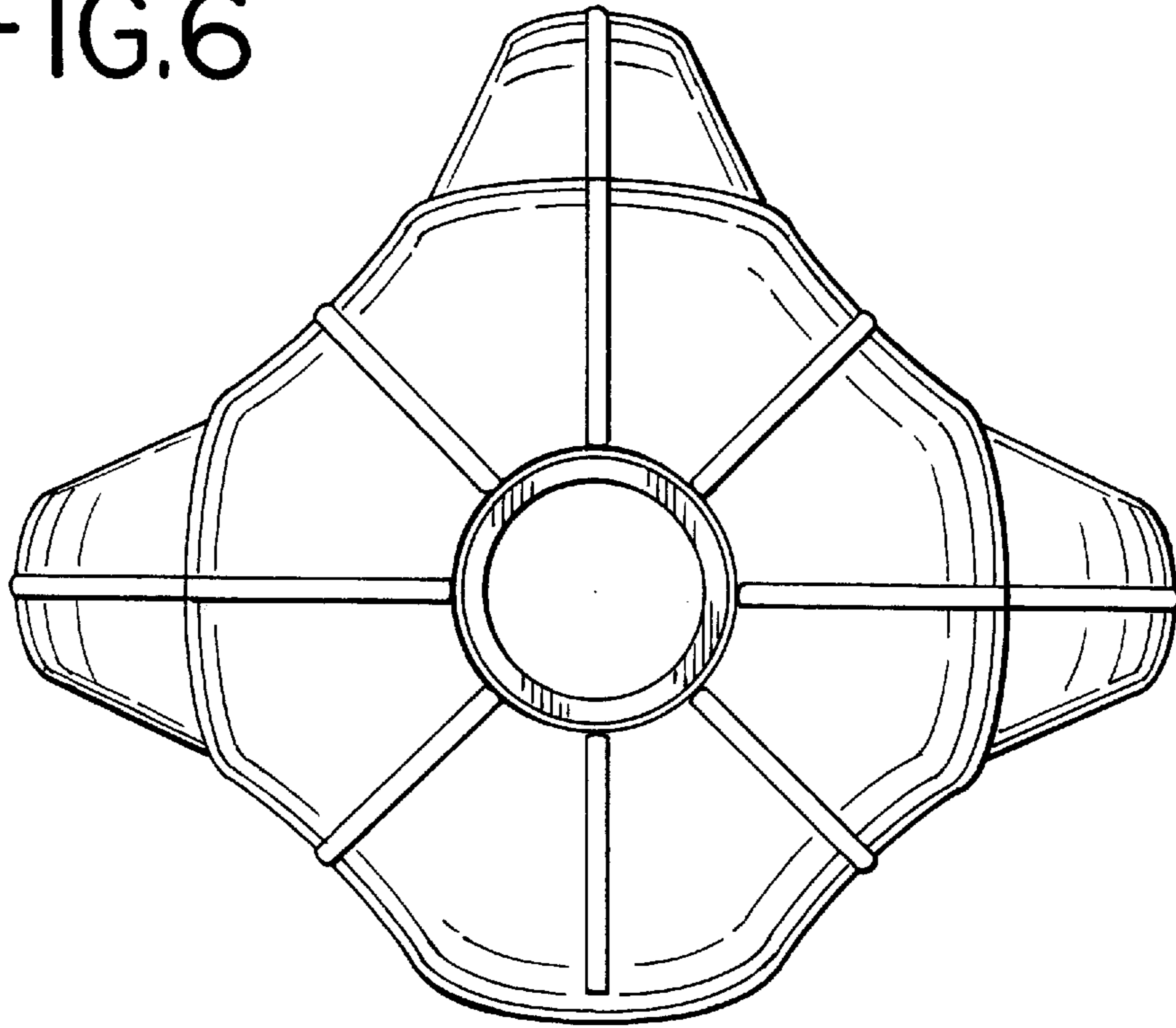

FIG.7

