



US00D438922S

(12) **United States Design Patent**
Asabuki

(10) **Patent No.:** **US D438,922 S**

(45) **Date of Patent:** **** Mar. 13, 2001**

(54) **WOOD-TYPE GOLF CLUB HEAD**

D. 422,327 * 4/2000 Takaoka et al. D21/733
1,574,915 * 3/1926 Marston 473/252

(75) Inventor: **Hideyo Asabuki**, Tokyo (JP)

* cited by examiner

(73) Assignee: **The Yokohama Rubber Co., Ltd.**,
Tokyo (JP)

Primary Examiner—Mitchell Siegel

(**) Term: **14 Years**

(74) *Attorney, Agent, or Firm*—Arent Fox Kintner Plotkin
& Kahn, PLLC

(21) Appl. No.: **29/124,231**

(57) **CLAIM**

(22) Filed: **Jun. 2, 2000**

The ornamental design for wood-type golf club head, as shown and described.

(30) **Foreign Application Priority Data**

DESCRIPTION

Dec. 28, 1999 (JP) 11-36046

FIG. 1 is a front view of a golf club, showing a new design;
FIG. 2 is a top plan view of FIG. 1;
FIG. 3 is a rear view of FIG. 1;
FIG. 4 is a bottom plan view of FIG. 1;
FIG. 5 is a left side view of FIG. 1;
FIG. 6 is a right side view of FIG. 1;
FIG. 7 is a perspective view of the front side of the golf club head of FIG. 1;
FIG. 8 is a perspective view of the rear side of the golf club head of FIG. 1; and,
FIG. 9 is a sectional view of the golf club head taken along the line 9—9 of FIG. 1.

(51) **LOC (7) Cl.** **21-02**

(52) **U.S. Cl.** **D21/733**

(58) **Field of Search** D21/733, 752;
473/252, 324, 327-331, 345, 346

(56) **References Cited**

U.S. PATENT DOCUMENTS

- D. 77,191 * 12/1928 Smith D21/738
- D. 363,100 * 10/1995 Long et al. D21/733
- D. 417,478 * 12/1999 Nagahama et al. D21/733
- D. 418,183 * 12/1999 Takaoka et al. D21/733
- D. 418,888 * 1/2000 William, Jr. D21/752

1 Claim, 5 Drawing Sheets

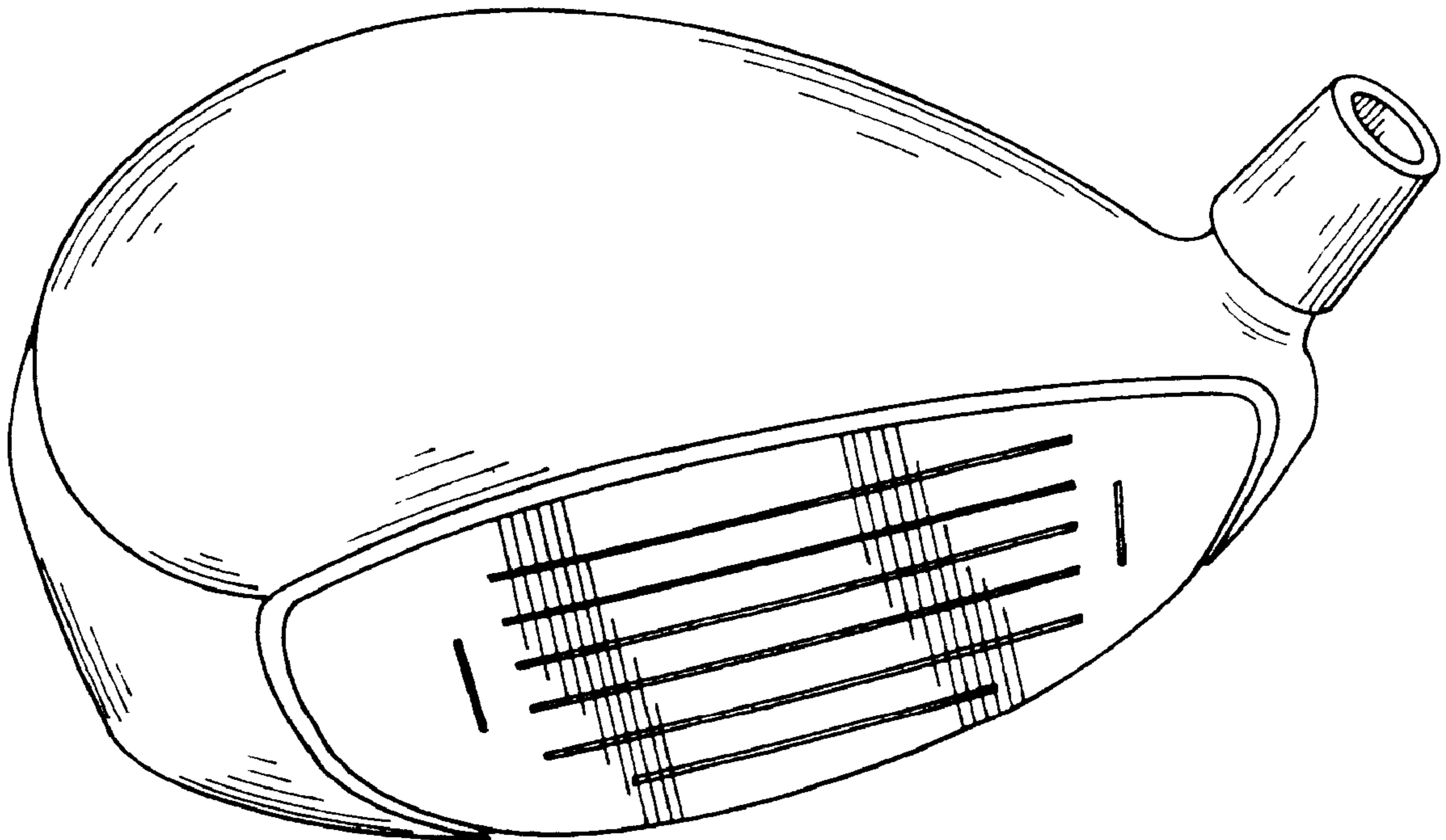

FIG. 1

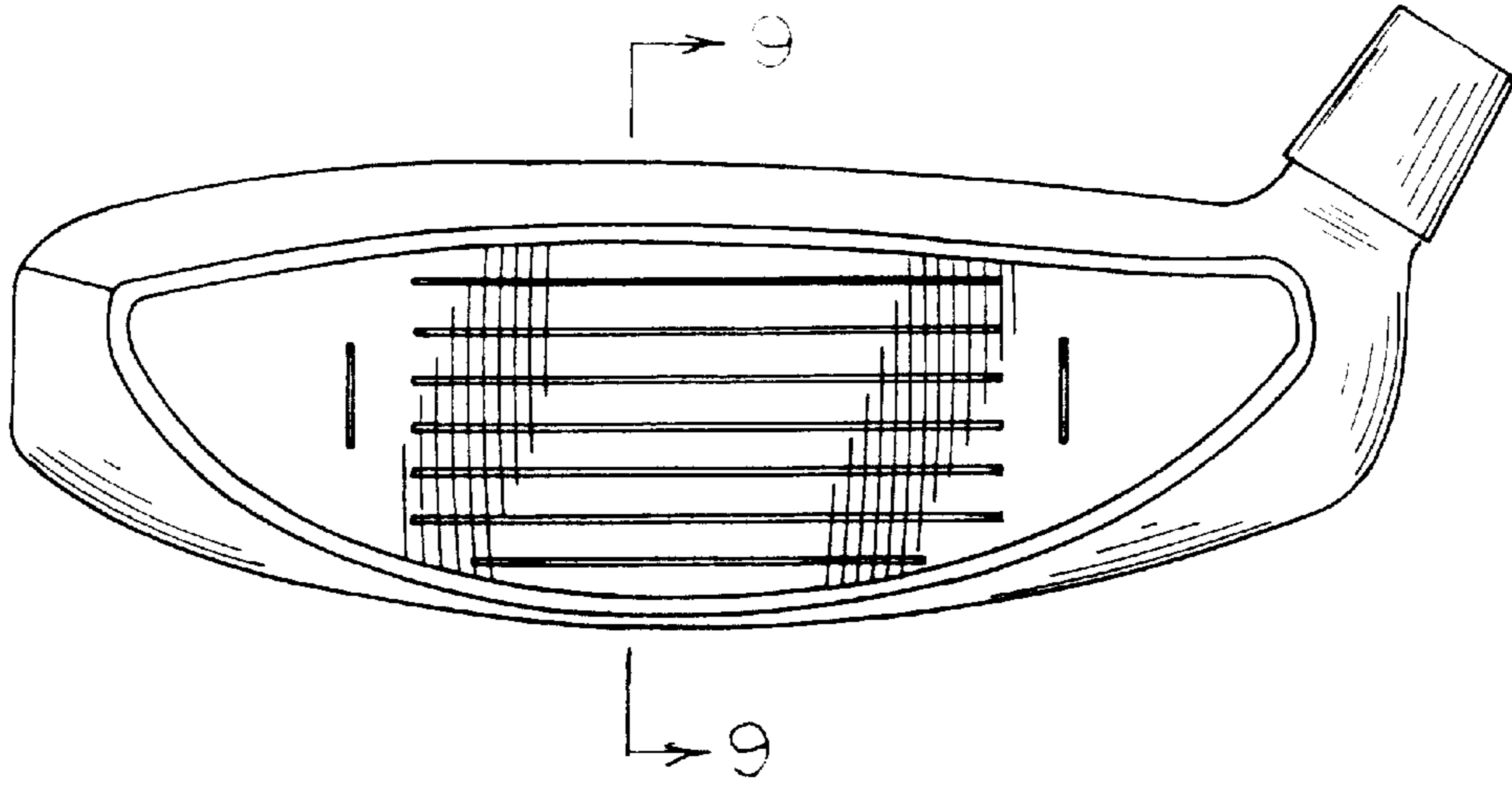

FIG. 2

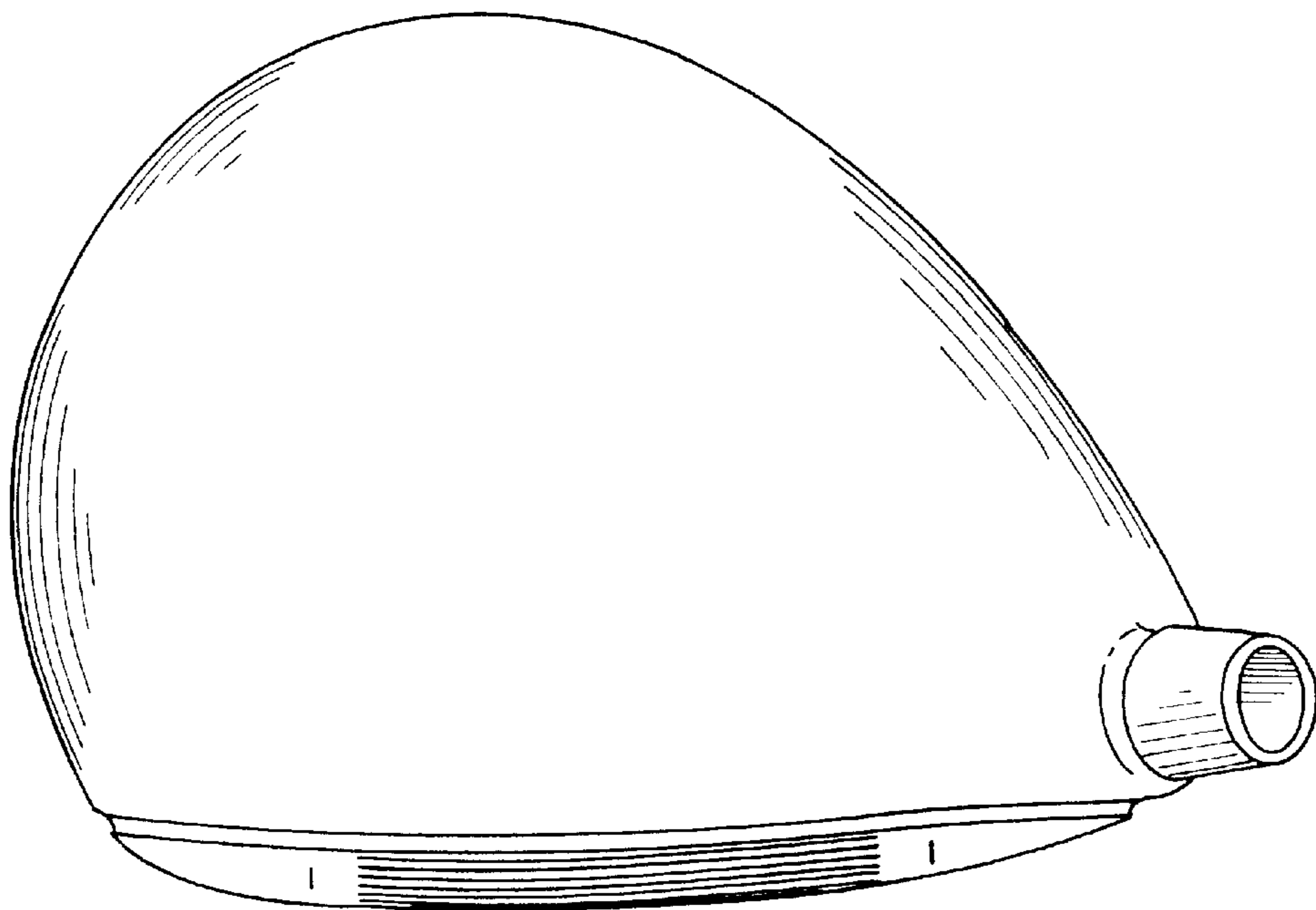

FIG. 3

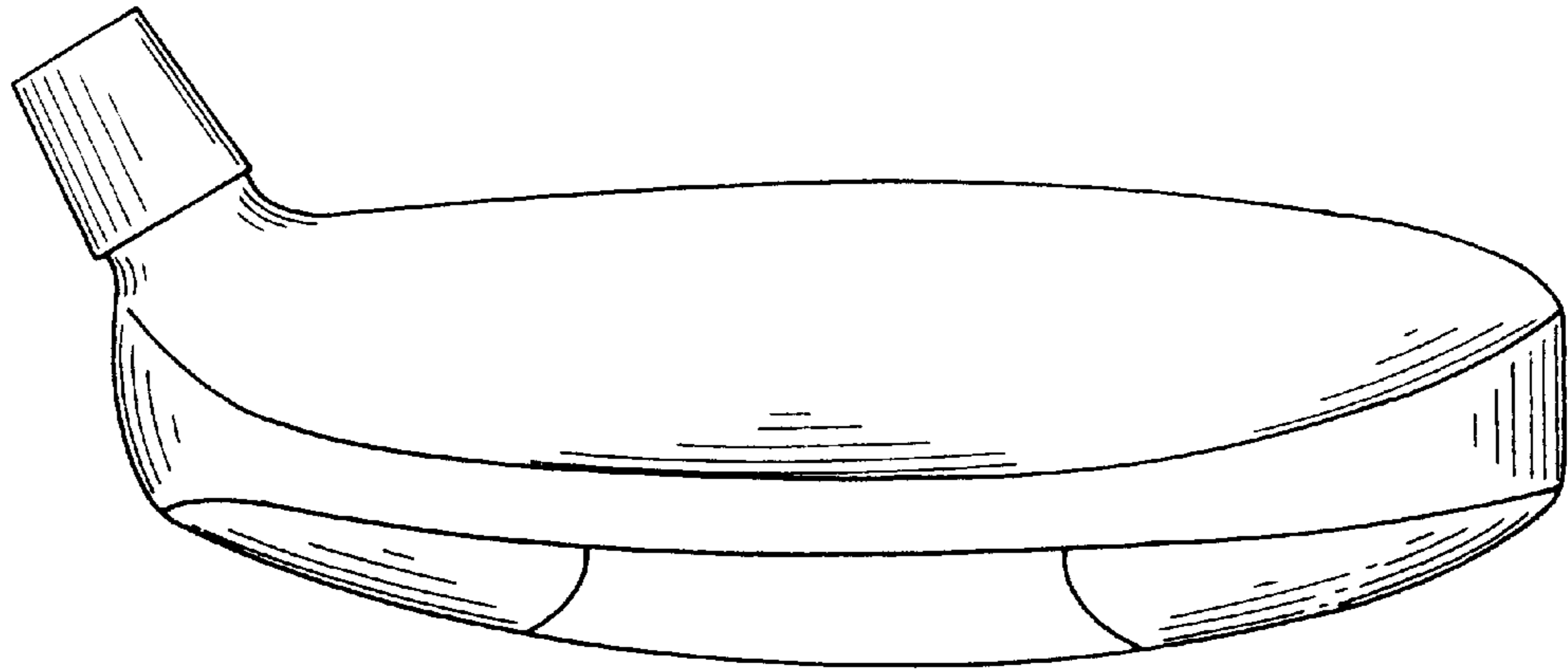

FIG. 4

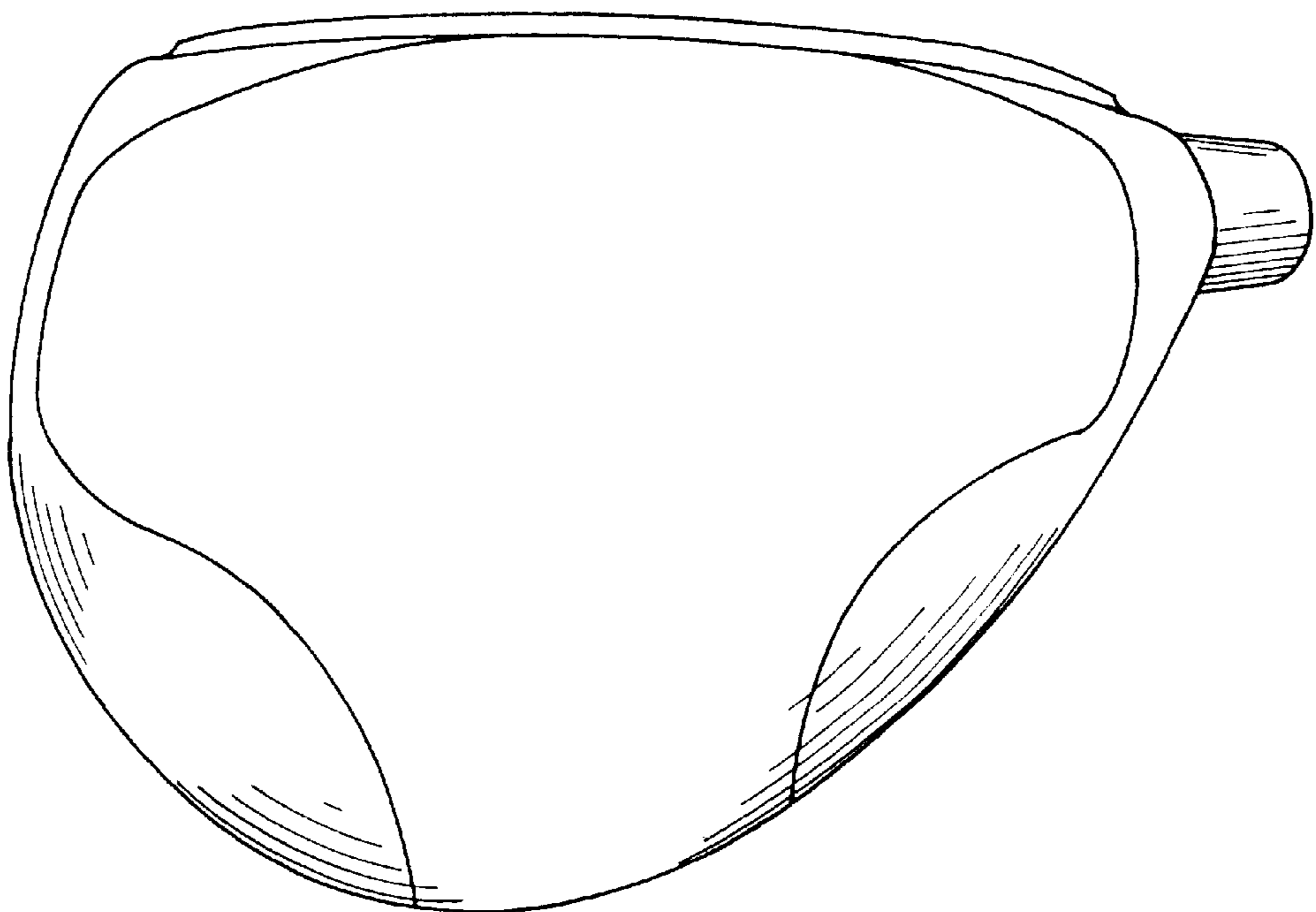

FIG. 5

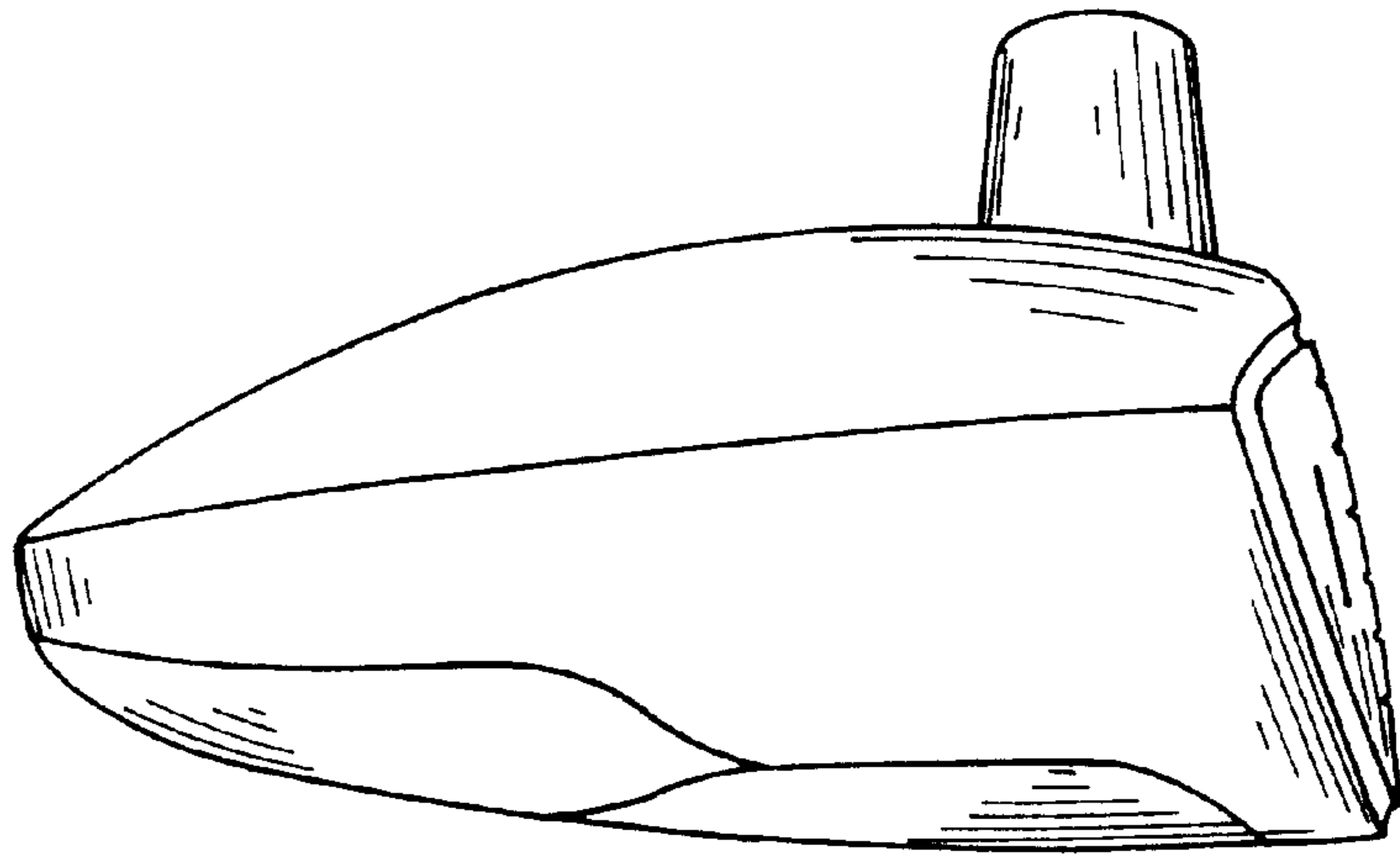

FIG. 6

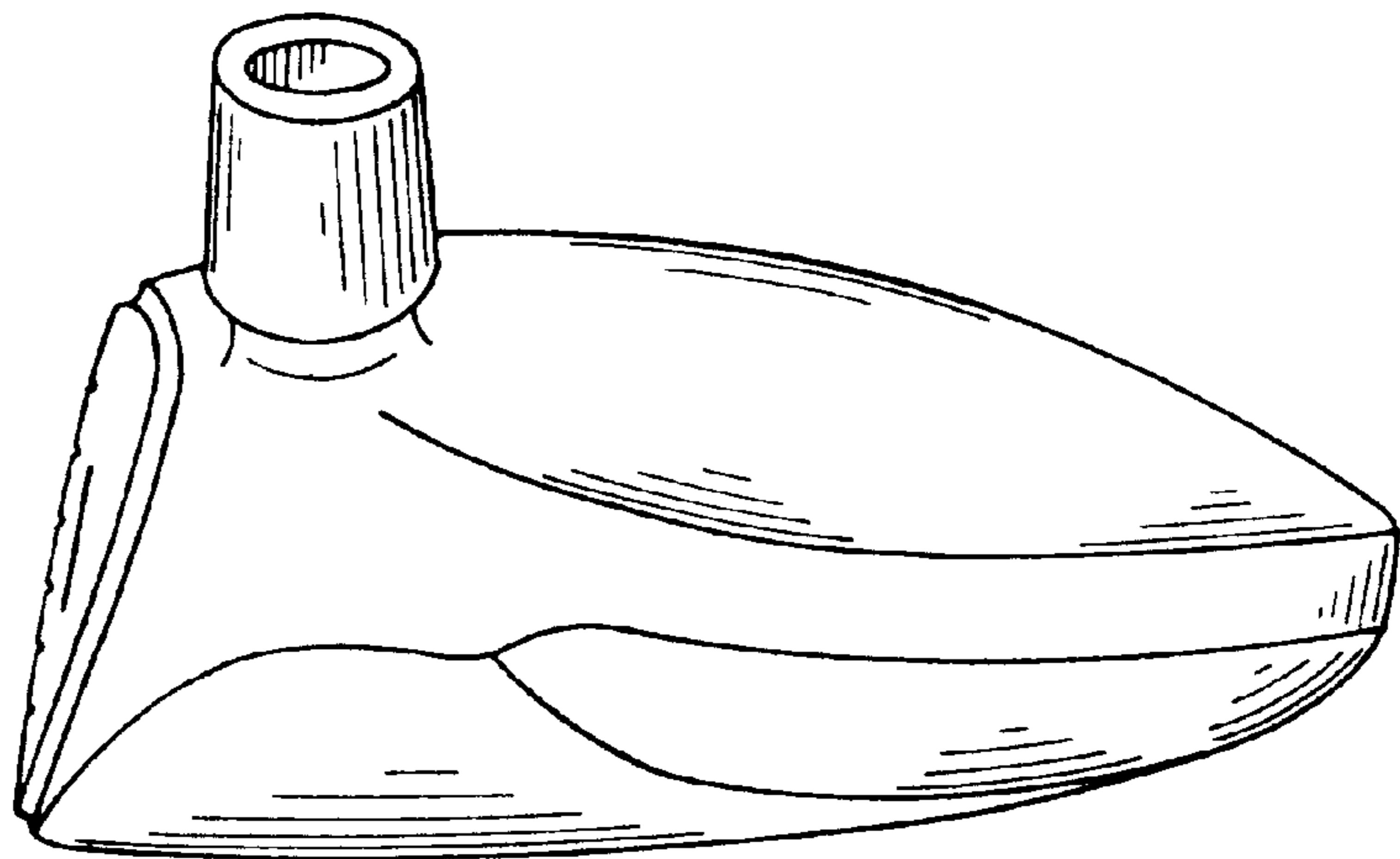

FIG. 7

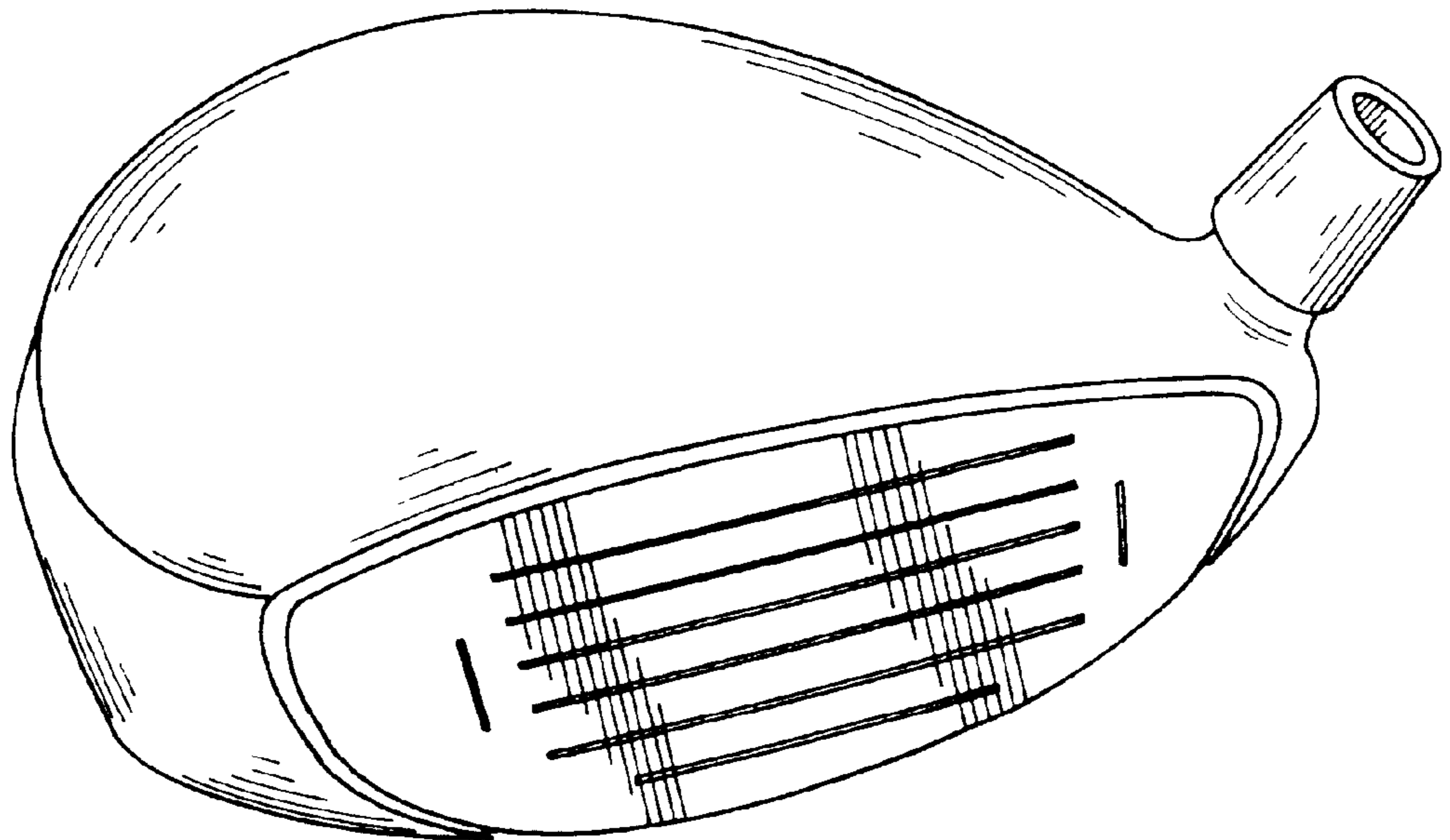

FIG. 8

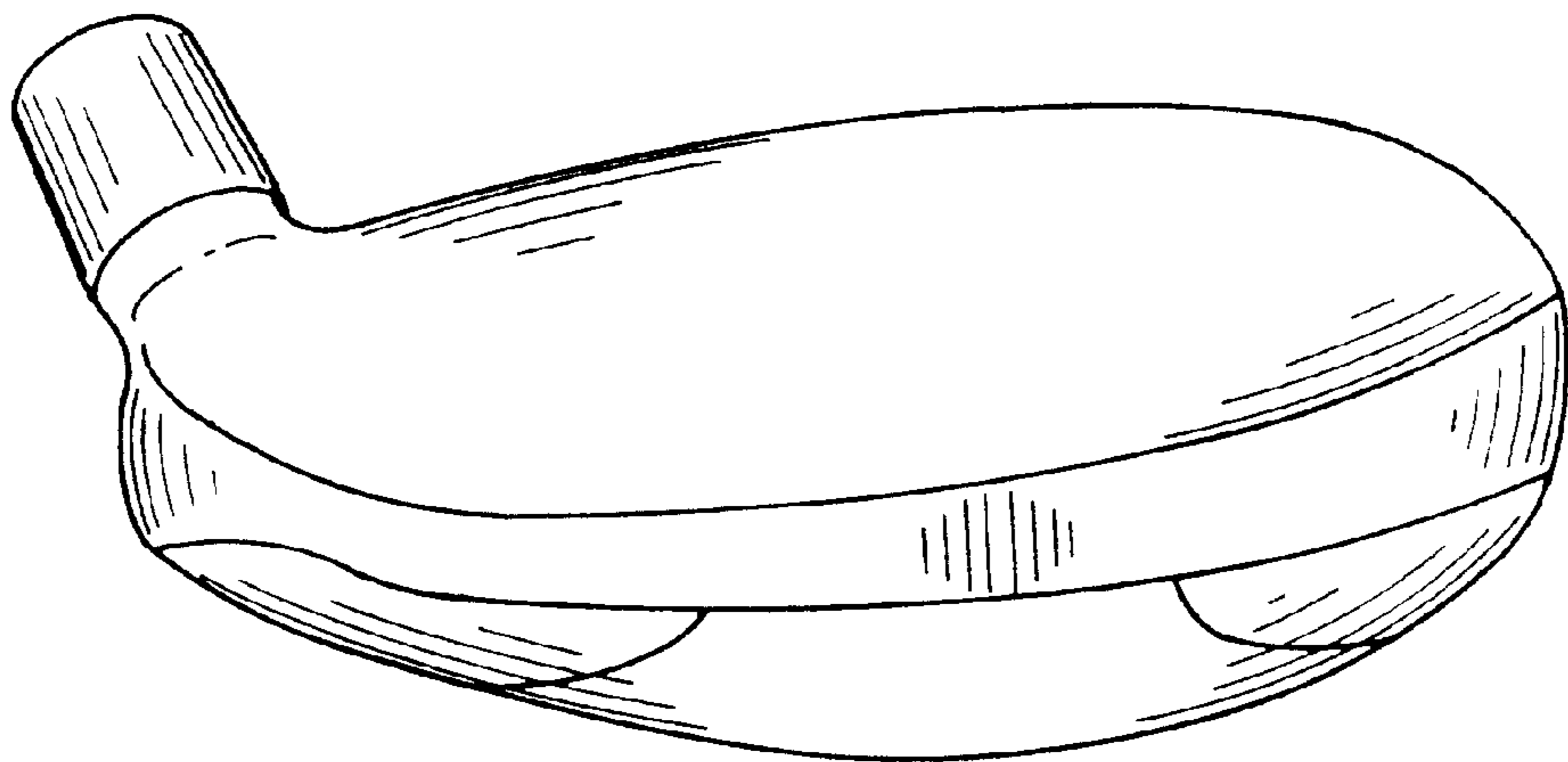

FIG. 9

