



US00D438921S

(12) **United States Design Patent**
Broadbridge

(10) **Patent No.:** **US D438,921 S**

(45) **Date of Patent:** **** Mar. 13, 2001**

(54) **GOLF CLUB HEAD**

(76) Inventor: **John Broadbridge**, 84 Shelter Rock Rd., Danbury, CT (US) 06810

(**) Term: **14 Years**

(21) Appl. No.: **29/121,573**

(22) Filed: **Apr. 10, 2000**

(51) **LOC (7) Cl.** **21-02**

(52) **U.S. Cl.** **D21/733**

(58) **Field of Search** D21/733, 752;
473/324, 327-331, 345, 346

(56) **References Cited**

U.S. PATENT DOCUMENTS

- D. 245,358 * 8/1977 Barber D21/752
- D. 390,616 * 2/1998 Maltby D21/733

* cited by examiner

Primary Examiner—Mitchell Siegel

(74) *Attorney, Agent, or Firm*—Dallett Hoopes

(57) **CLAIM**

The ornamental design for a golf club head, as shown and described.

DESCRIPTION

FIG. 1 is a perspective view of a golf club head, the broken line showing of a shaft is for illustrative purposes and forms no part of the claimed design;

FIG. 2 is an enlarged perspective view of the head;

FIG. 3 is a perspective view from the rear;

FIG. 4 is a top plan view;

FIG. 5 is a front elevation;

FIG. 6 is a right side elevation;

FIG. 7 is a left side elevation;

FIG. 8 is a rear elevation;

FIG. 9 is a bottom plan view;

FIG. 10 is a front perspective of a second embodiment of the golf club head as disclosed in FIG. 1; and,

FIG. 11 is a left side elevation of the modified form of the design.

The undisclosed sides of the second embodiment are identical to those disclosed in the first embodiment.

1 Claim, 4 Drawing Sheets

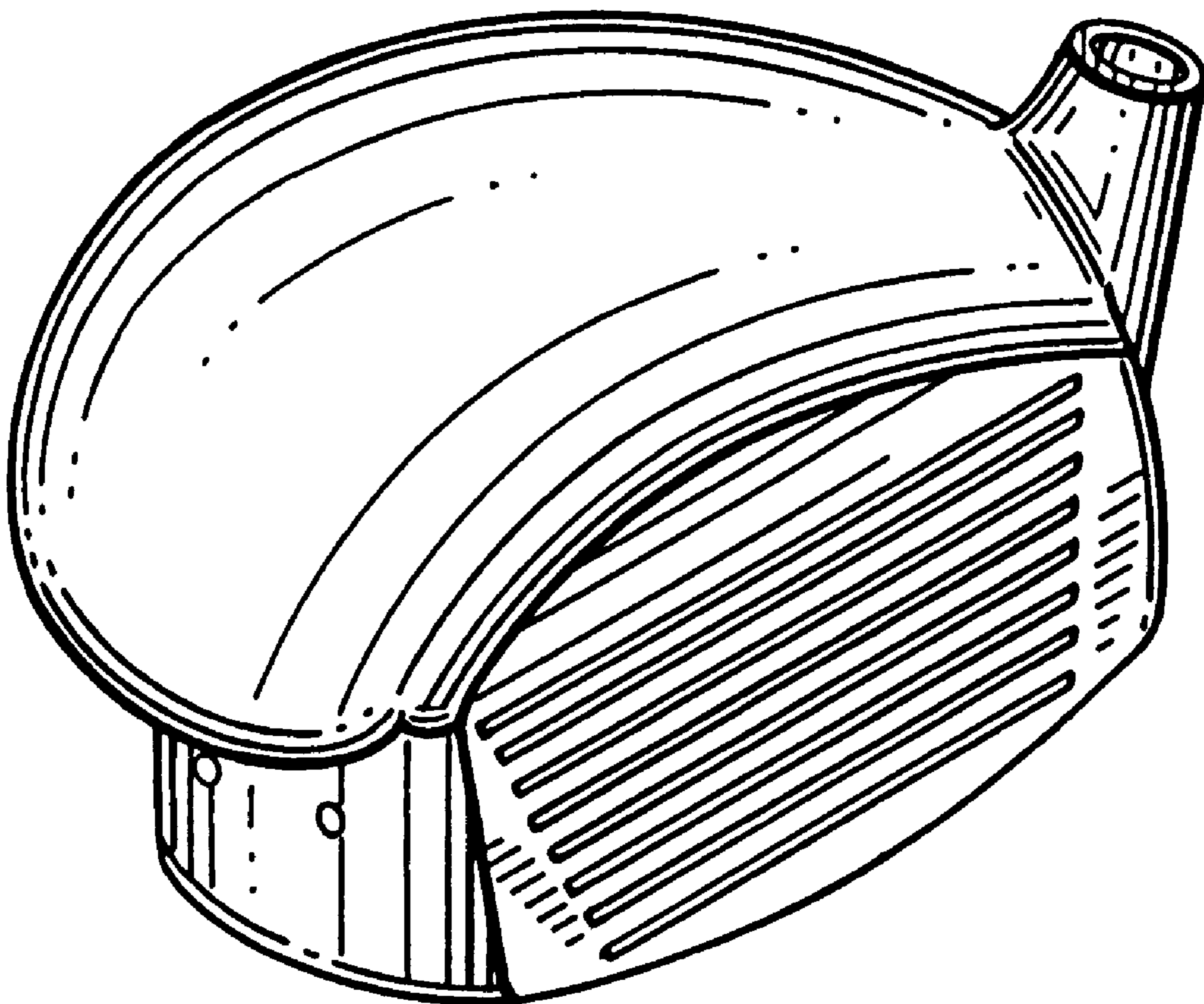

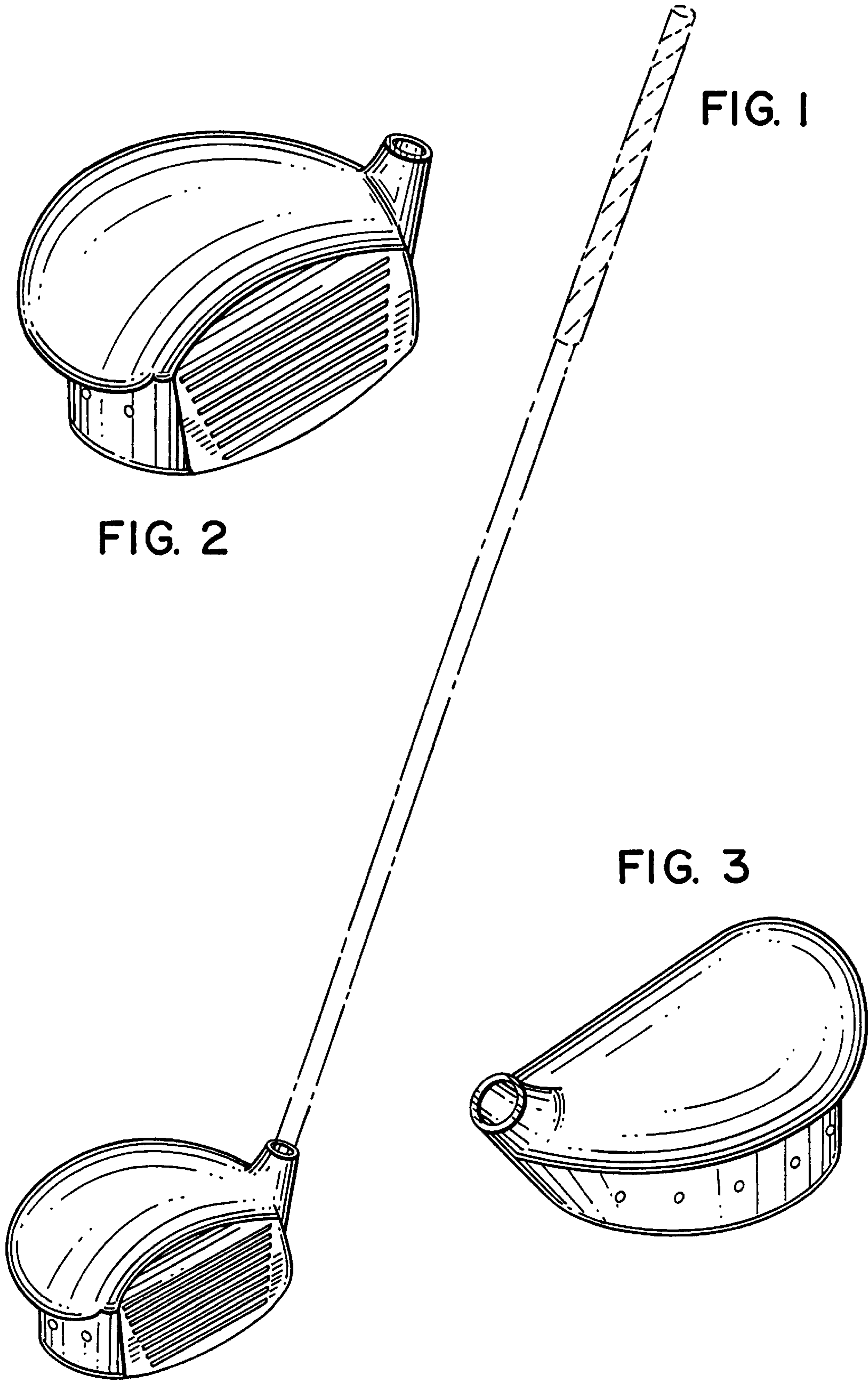

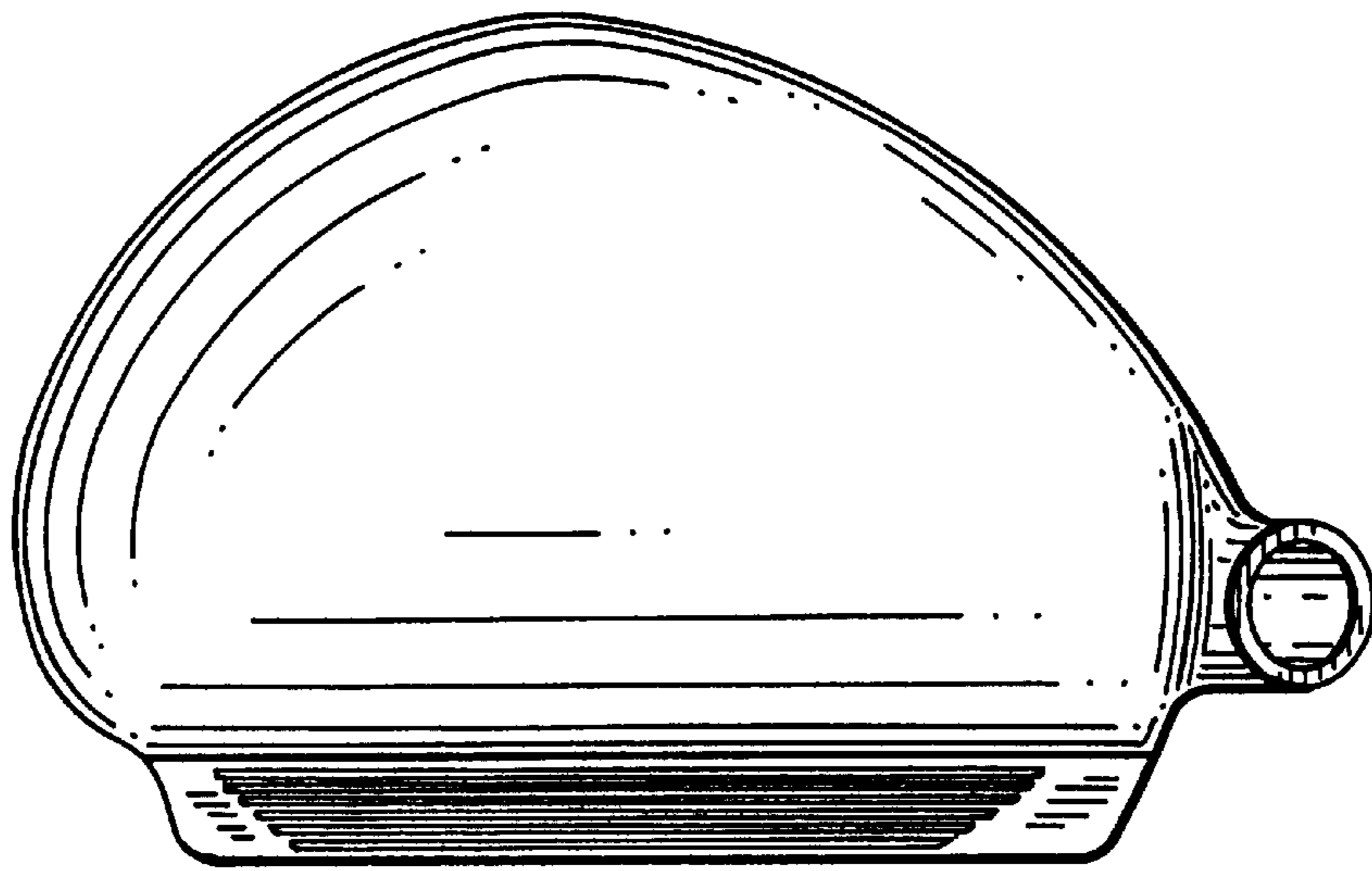

FIG. 4

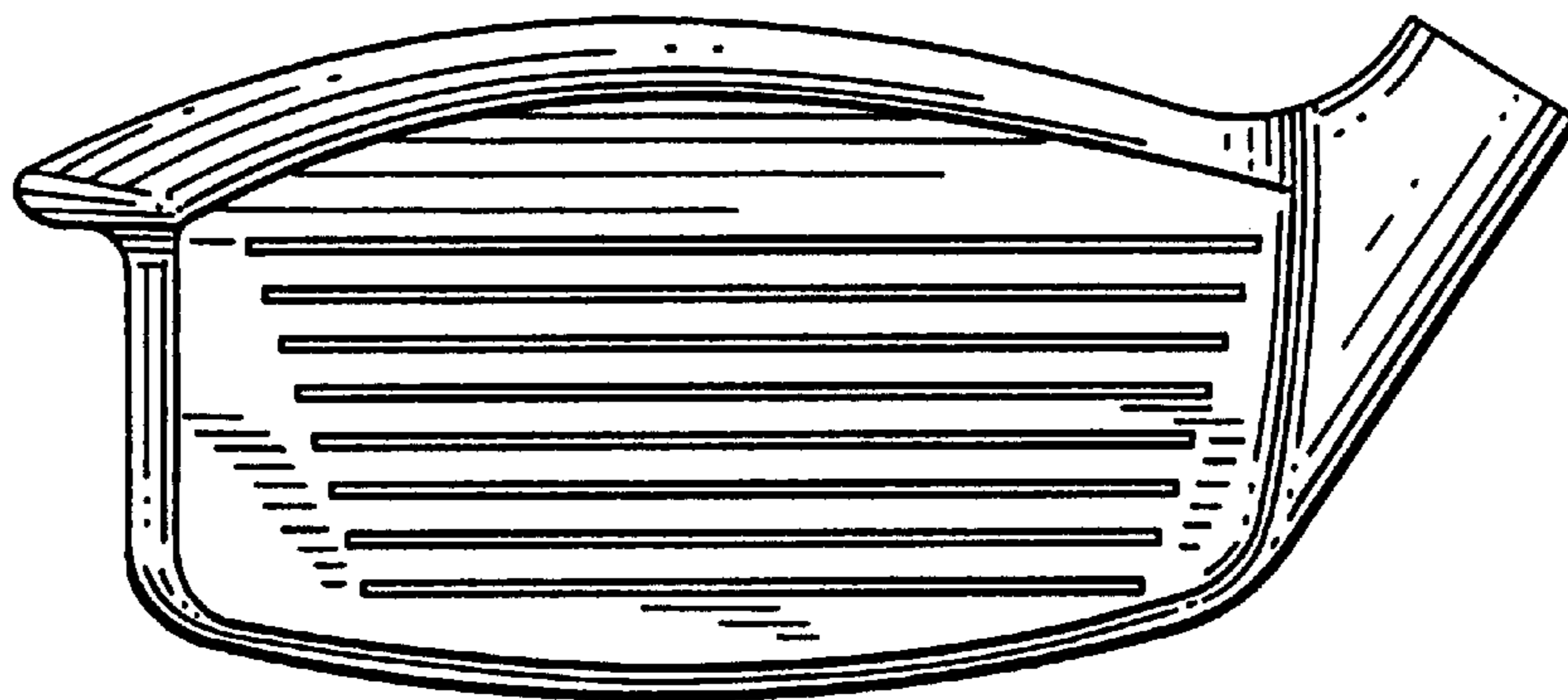

FIG. 5

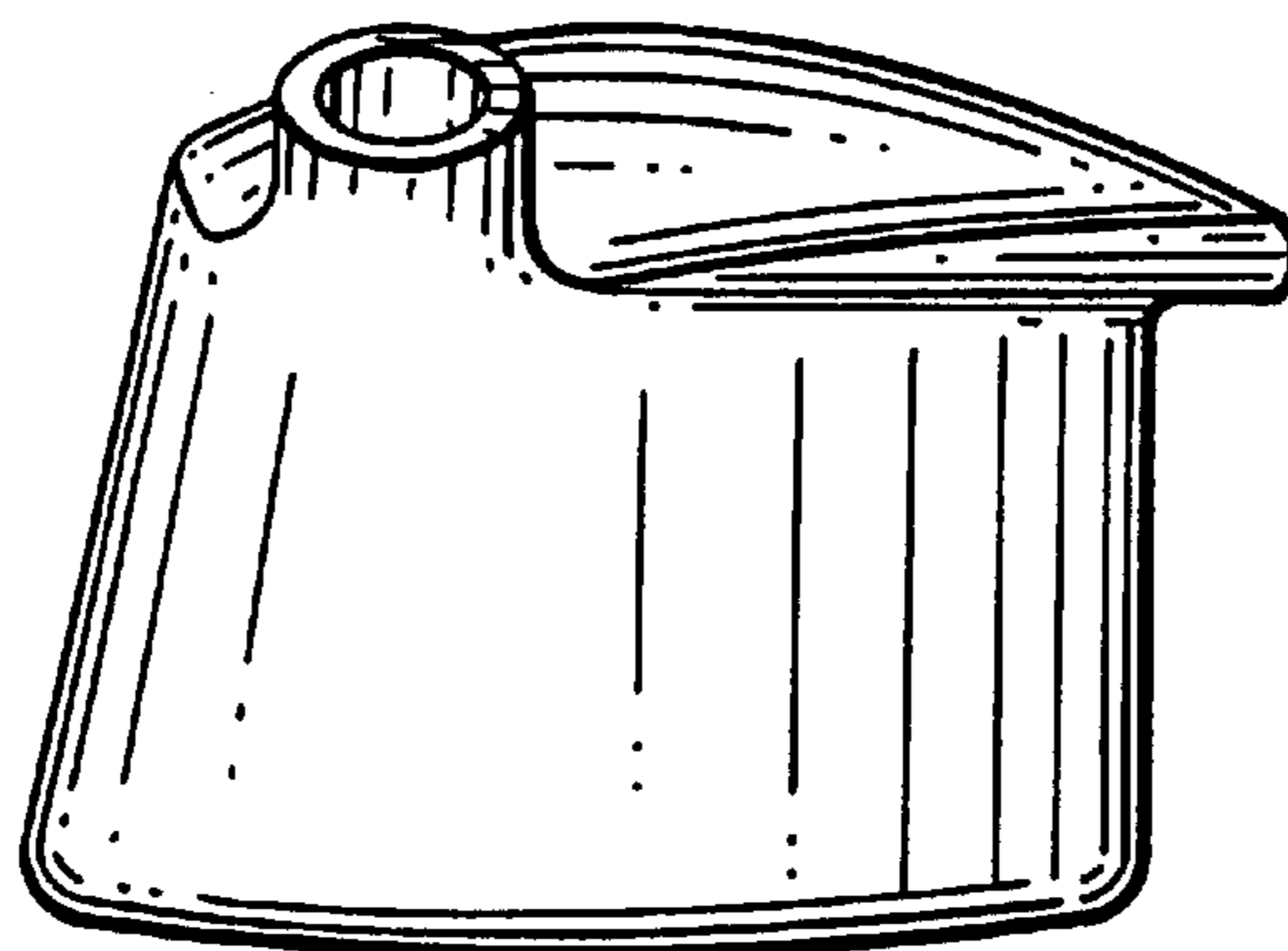

FIG. 6

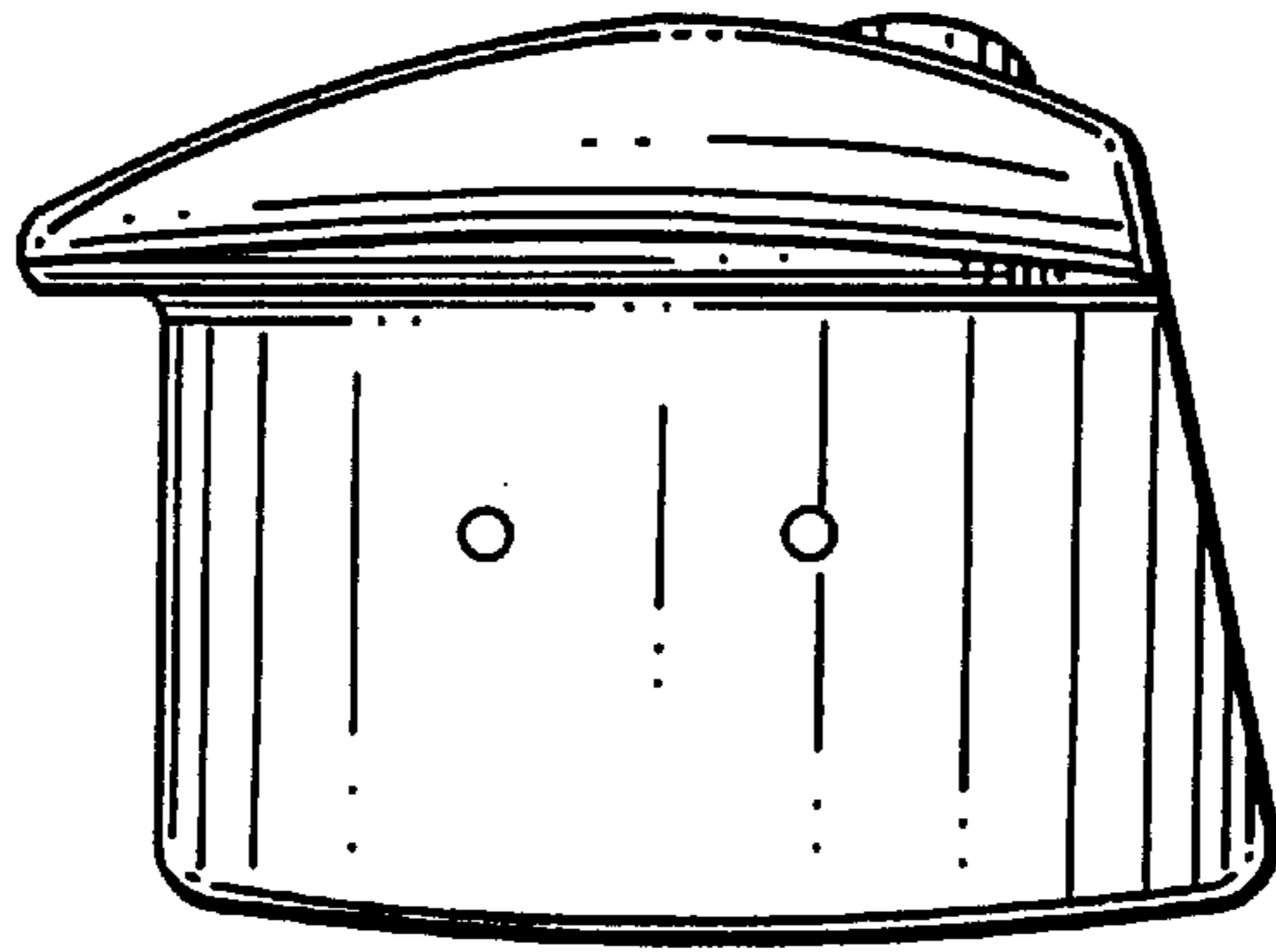

FIG. 7

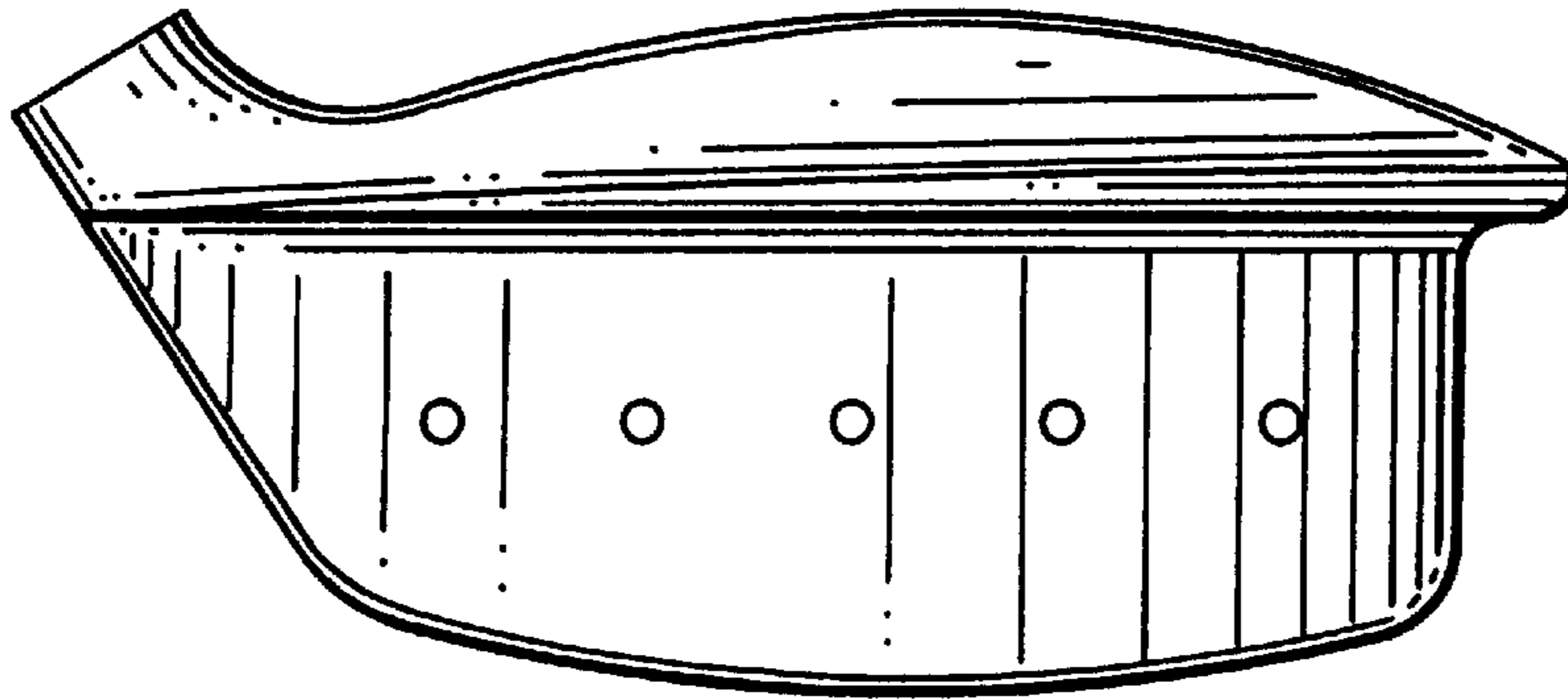

FIG. 8

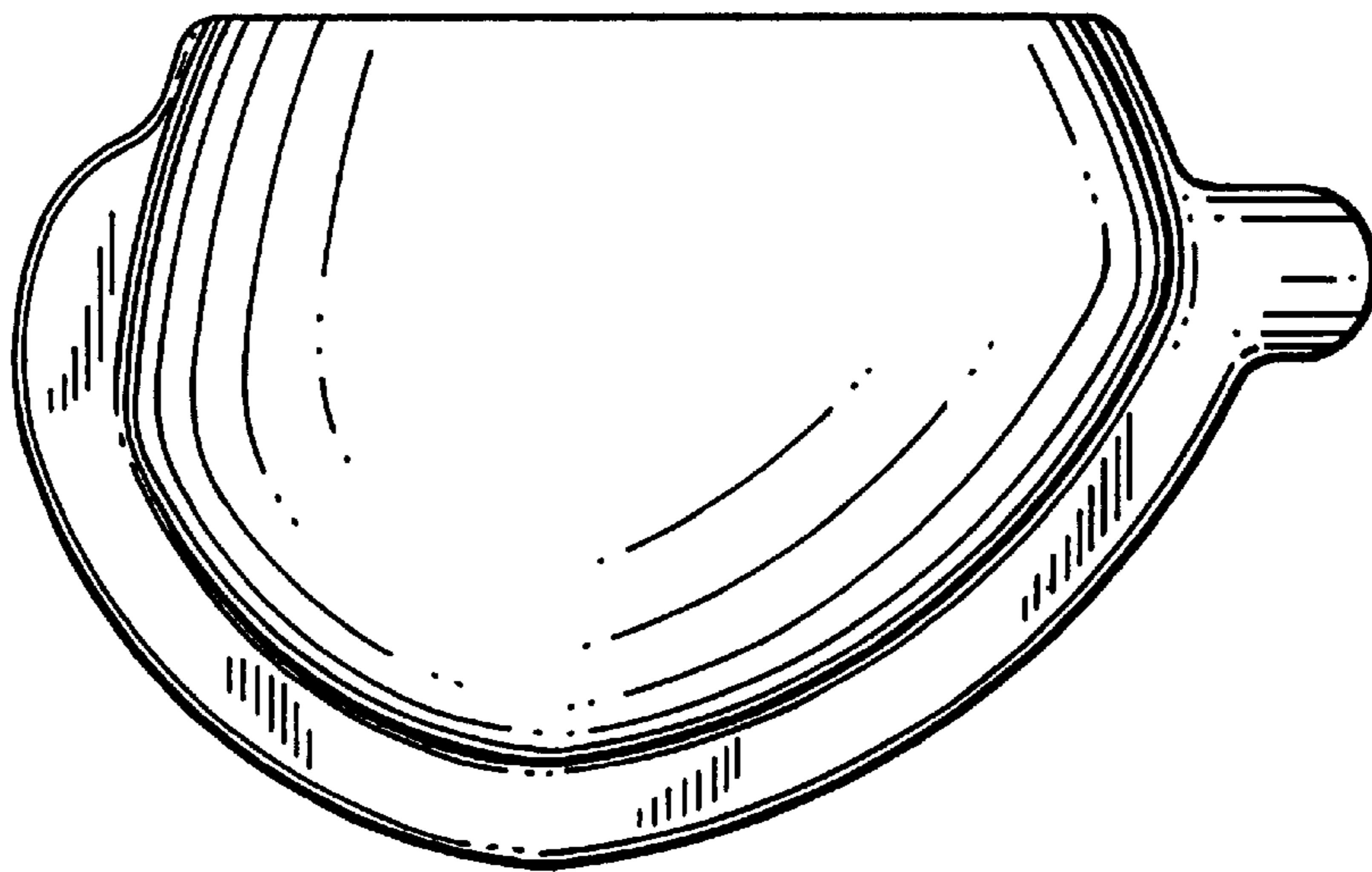

FIG. 9

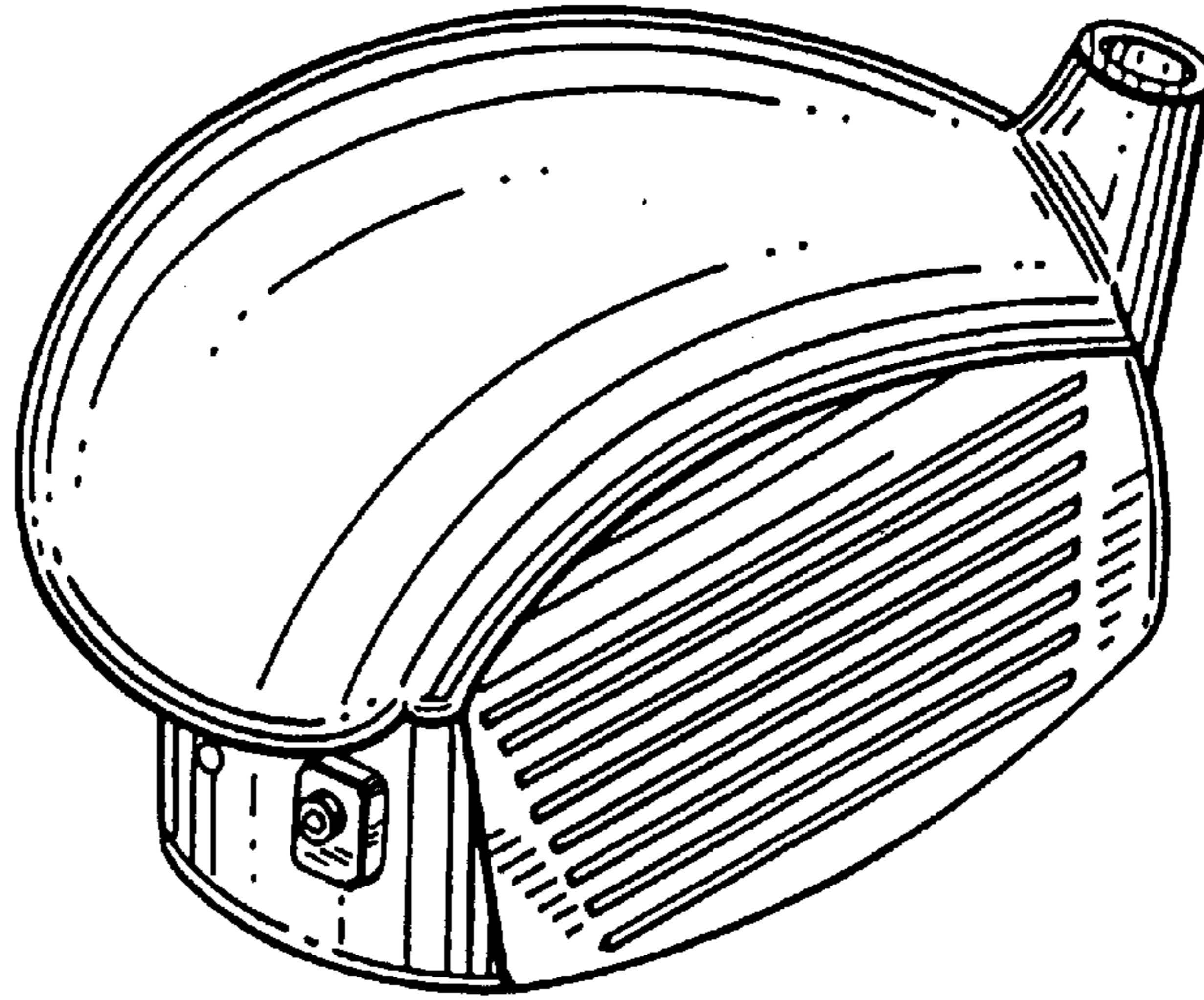

FIG. 10

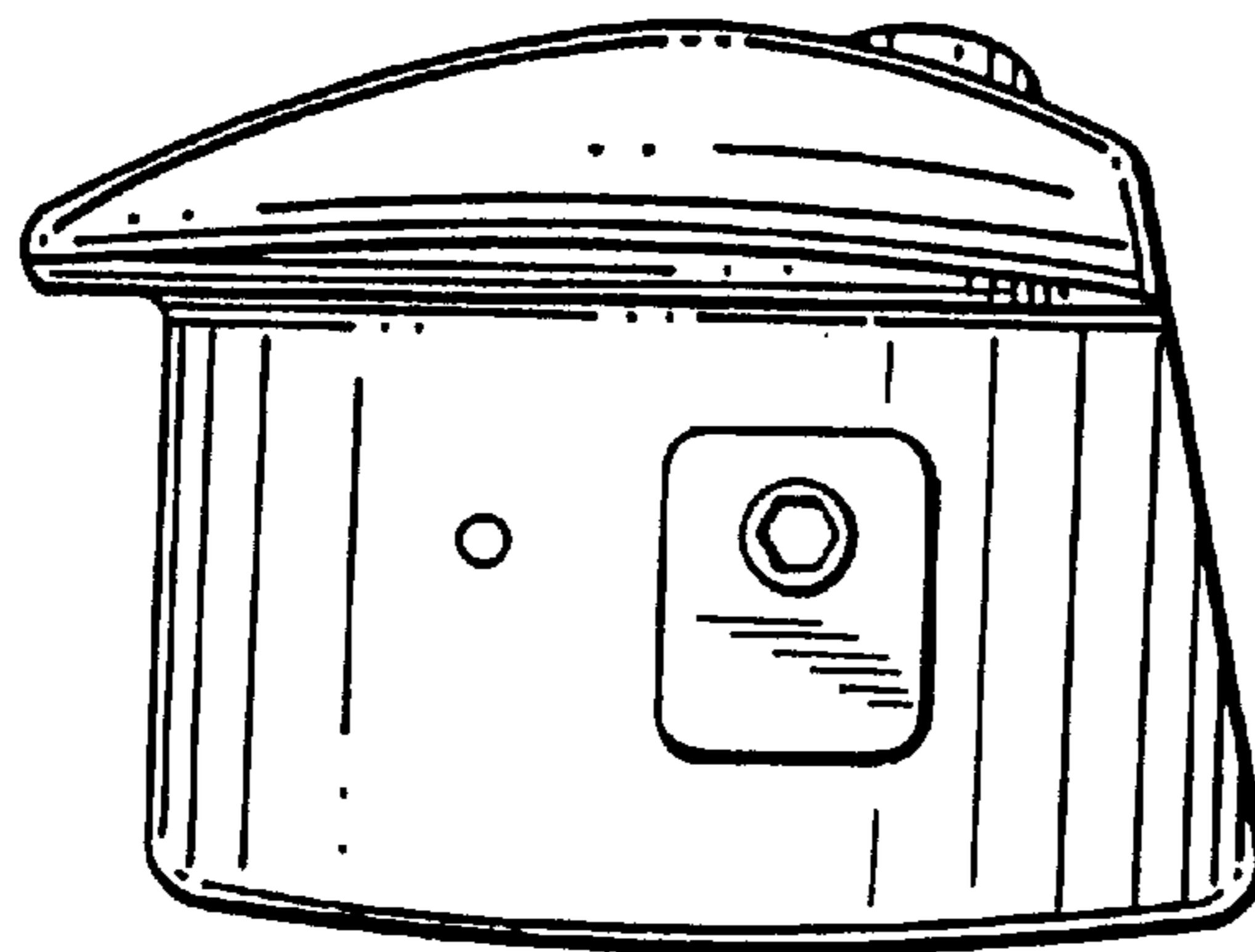

FIG. 11