



US00D438920S

(12) **United States Design Patent**  
**Matteucci et al.**

(10) **Patent No.:** **US D438,920 S**

(45) **Date of Patent:** **\*\* Mar. 13, 2001**

(54) **BASKETBALL BACKBOARD**

(75) Inventors: **Ron Matteucci**, Waukesha; **Ron White**, North Praire, both of WI (US)

(73) Assignee: **Huffy Corporation**, Miamisburg, OH (US)

(\*\*) Term: **14 Years**

(21) Appl. No.: **29/123,078**

(22) Filed: **May 11, 2000**

(51) **LOC (7) Cl.** ..... **21-02**

(52) **U.S. Cl.** ..... **D21/701; D21/703; D21/704**

(58) **Field of Search** ..... **D21/701, 703, D21/704; 473/481-483**

(56) **References Cited**

**U.S. PATENT DOCUMENTS**

D. 402,238 \* 12/1998 Davis ..... D21/701

D. 431,620 \* 10/2000 Hill ..... D21/704

6,004,231 \* 12/1999 Schickert ..... 473/481

\* cited by examiner

*Primary Examiner*—Dominic Simone

(74) *Attorney, Agent, or Firm*—Howrey Simon Arnold & White; Michael J. Bell

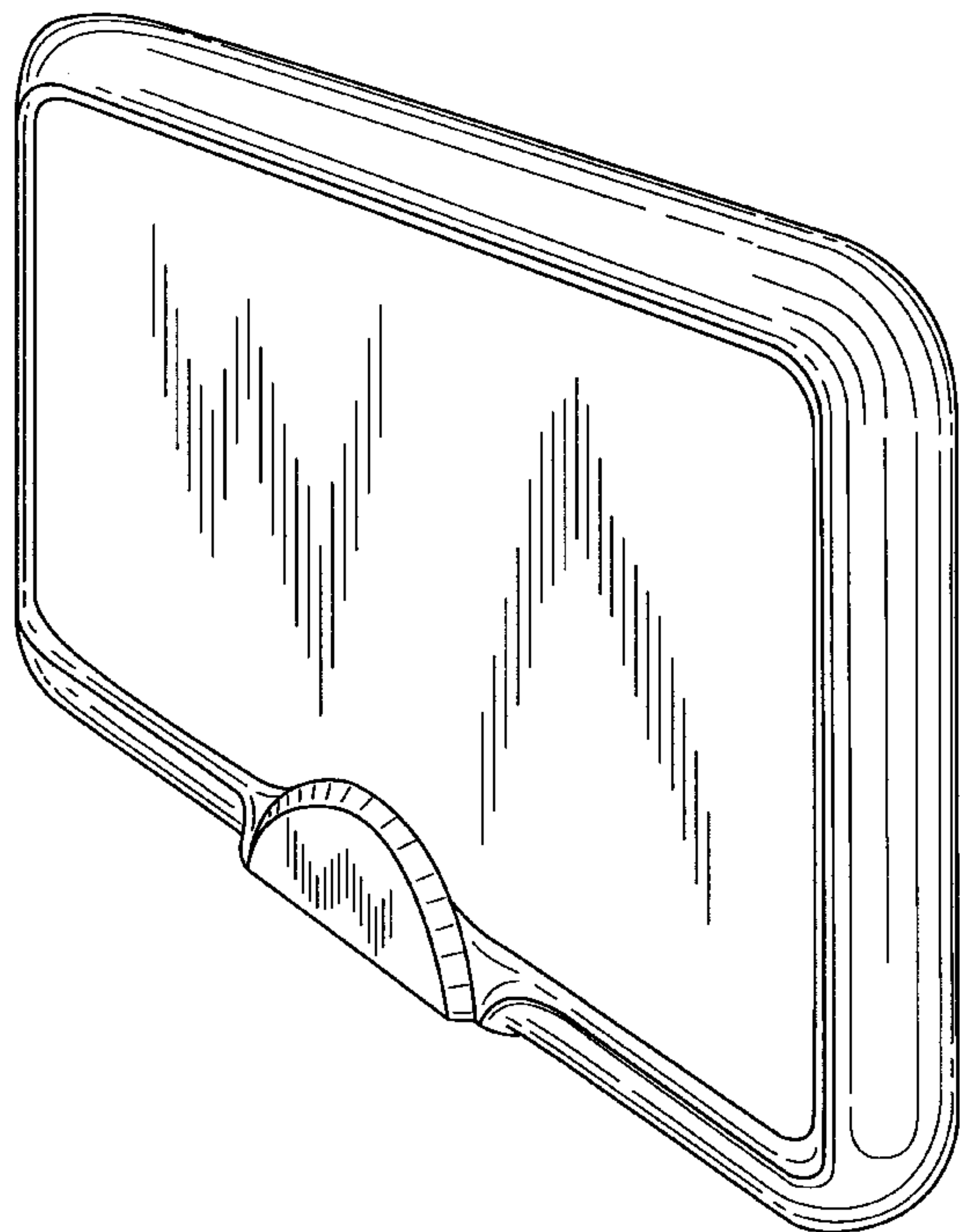
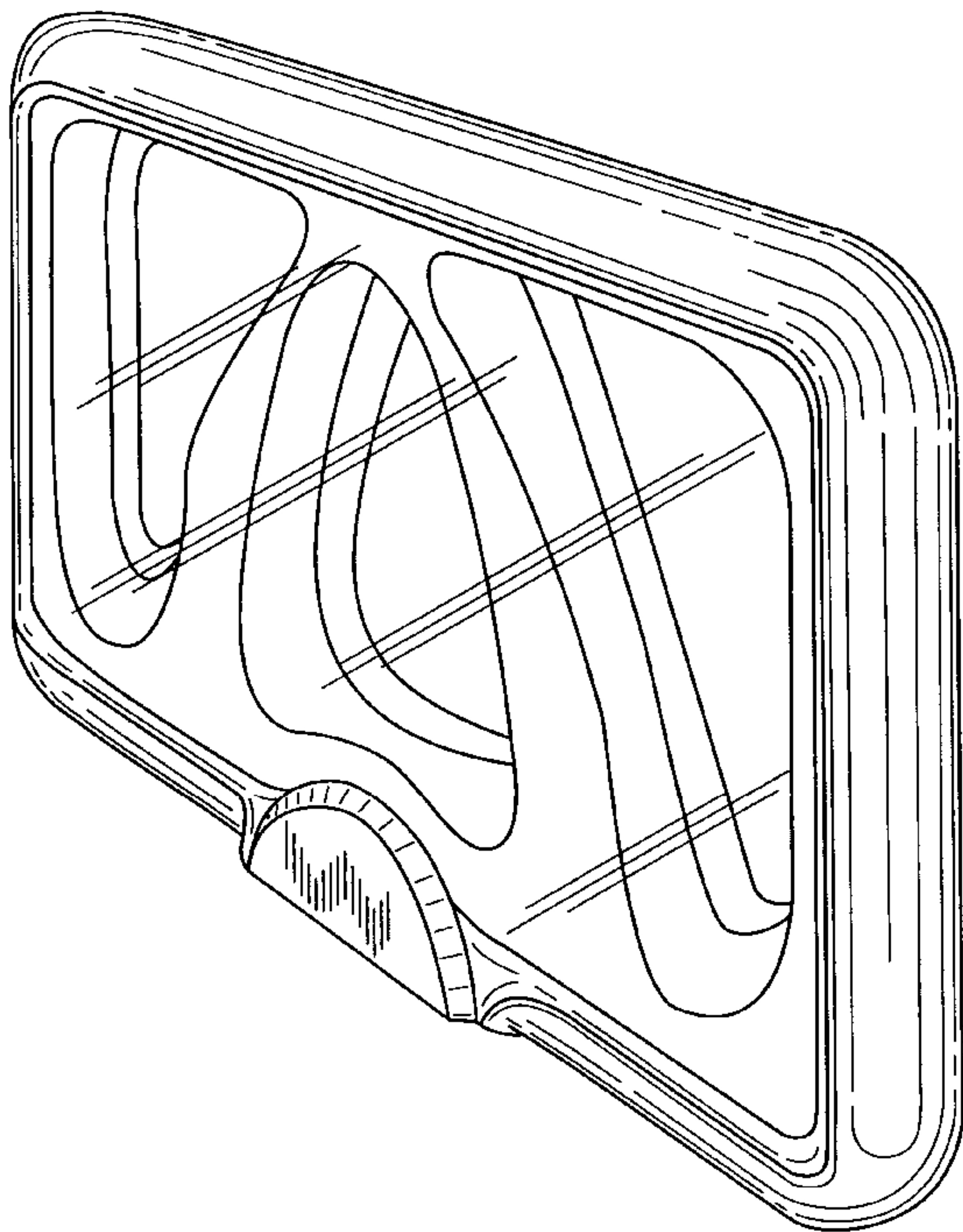
(57) **CLAIM**

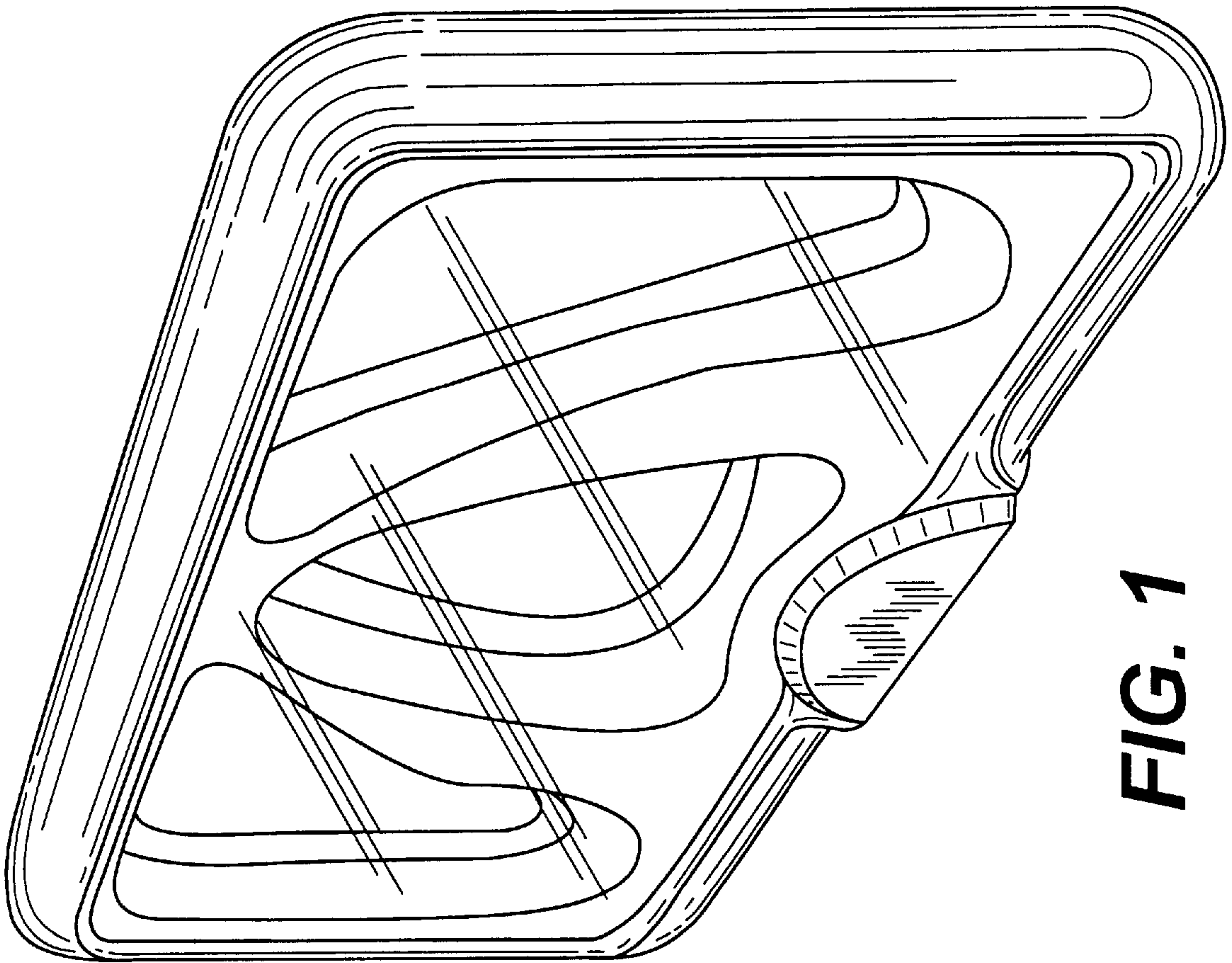
The ornamental design for a basketball backboard, as shown and described.

**DESCRIPTION**

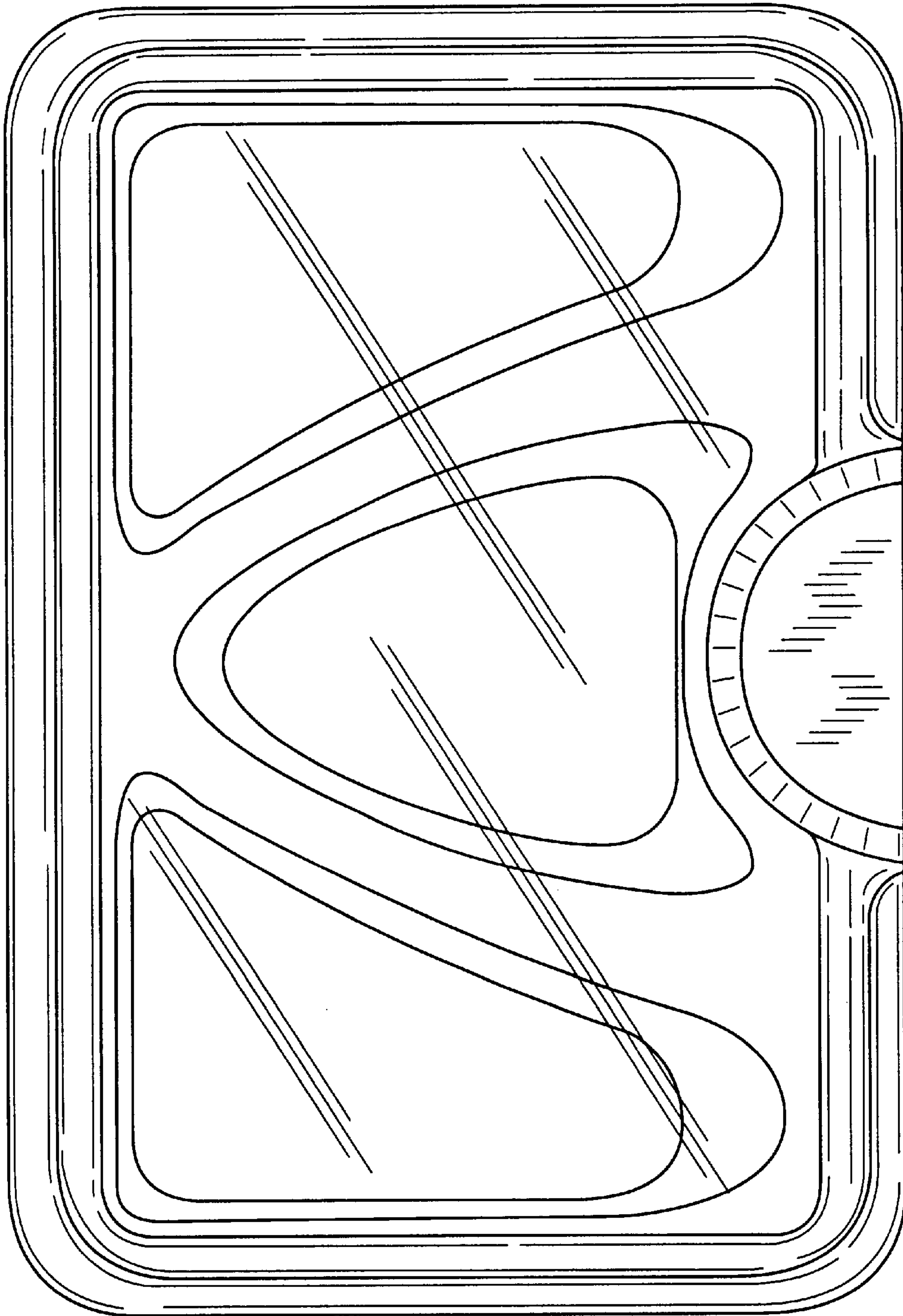
FIG. 1 is a perspective view of a basketball backboard embodying our design with a center transparent panel; FIG. 2 is a front elevational view thereof; FIG. 3 is a rear elevational view thereof; FIG. 4 is a top plan view thereof; FIG. 5 is a bottom plan view thereof; FIG. 6 is a left side elevational view thereof, the right side elevational view being a mirror image thereof; and, FIG. 7 is a perspective view of a second embodiment of our invention with the center panel opaque or translucent.

**1 Claim, 5 Drawing Sheets**



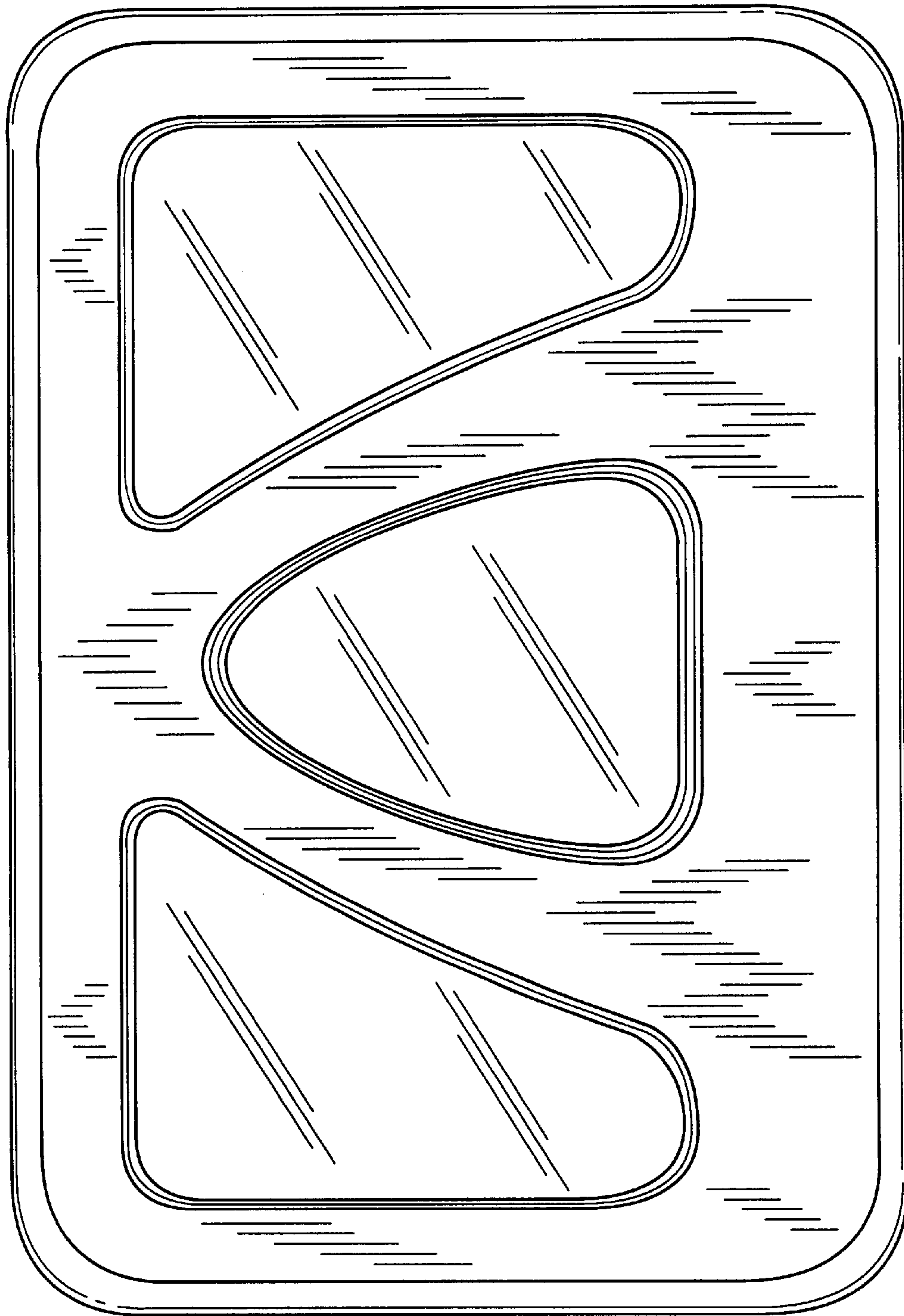


**FIG. 1**

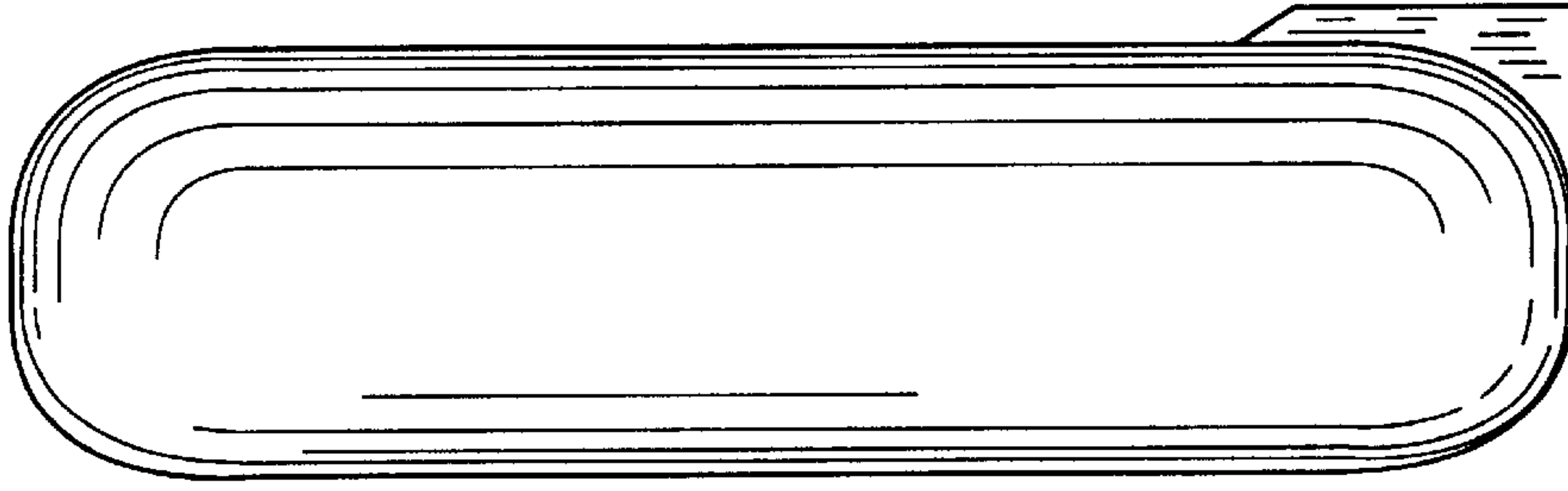


**FIG. 2**

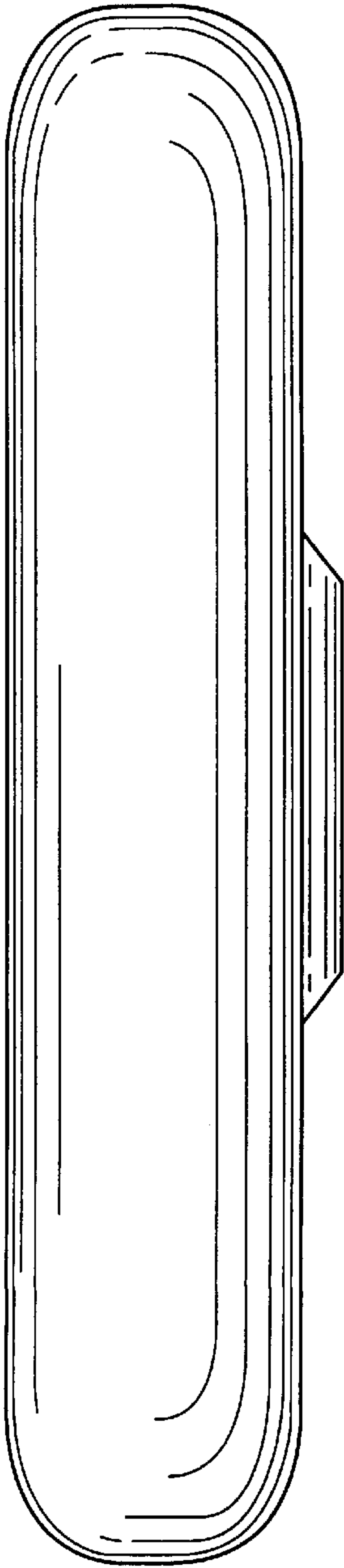




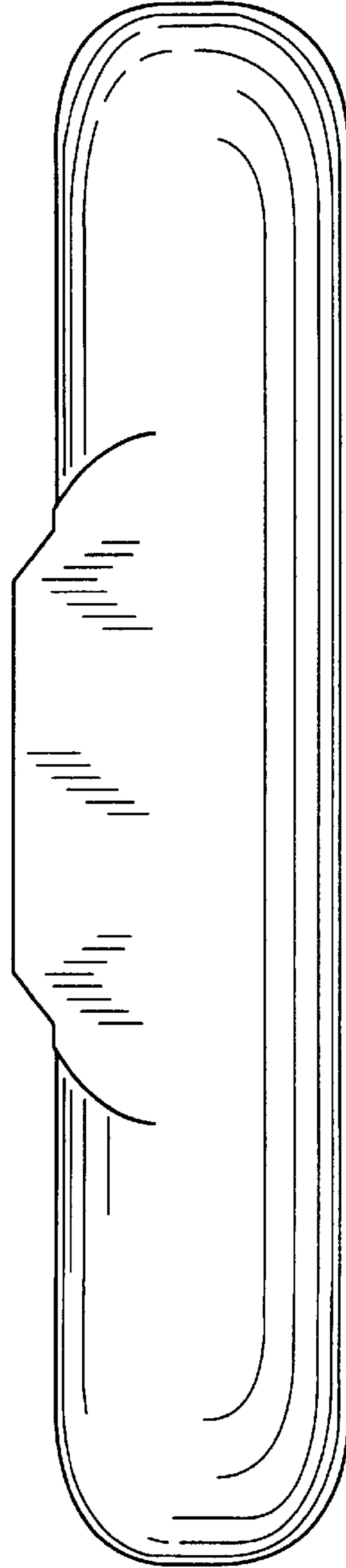
**FIG. 3**



**FIG. 6**



**FIG. 4**



**FIG. 5**

