



US00D438811S

(12) **United States Design Patent**
Iwamoto

(10) **Patent No.:** **US D438,811 S**

(45) **Date of Patent:** **** Mar. 13, 2001**

(54) **PROTECTOR FOR A WRISTWATCH**

2,565,822 * 8/1951 McClelland 368/286

(75) Inventor: **Masakazu Iwamoto**, Fussa (JP)

* cited by examiner

(73) Assignee: **Casio Keisanki Kabushiki Kaisha**,
Tokyo (JP)

Primary Examiner—Nelson C. Holtje
(74) *Attorney, Agent, or Firm*—Frishauf, Holtz, Goodman,
Langer & Chick, P.C.

(**) Term: **14 Years**

(57) **CLAIM**

(21) Appl. No.: **29/123,751**

The ornamental design for a protector for a wristwatch, as shown and described.

(22) Filed: **May 24, 2000**

(51) **LOC (7) Cl.** **10-03**

(52) **U.S. Cl.** **D10/132**

(58) **Field of Search** D10/132, 30-39;
368/285, 286

DESCRIPTION

FIG. 1 is a front elevational view of a protector for a wristwatch, showing my new design;
FIG. 2 is a right side elevational view thereof;
FIG. 3 is a left side elevational view thereof;
FIG. 4 is a top plan view thereof;
FIG. 5 is a bottom plan view thereof;
FIG. 6 is a rear elevational view thereof;
FIG. 7 is a front, bottom and right side perspective view thereof; and,
FIG. 8 is a reference view showing the state of use thereof and the broken line portions are illustrated to show the environment only and form no part of the claimed design.

(56) **References Cited**

U.S. PATENT DOCUMENTS

- D. 292,678 * 11/1987 Takeichi D10/39
- D. 387,678 * 12/1997 Yamamoto D10/31
- D. 387,679 * 12/1997 Hanagata D10/31
- D. 387,680 * 12/1997 Hanagata D10/31
- D. 395,404 * 6/1998 Hanagata D10/31
- D. 401,162 * 11/1998 Ishizaka et al. D10/31
- D. 410,865 * 6/1999 Myers D10/132
- D. 419,101 * 1/2000 Myers D10/132

1 Claim, 2 Drawing Sheets

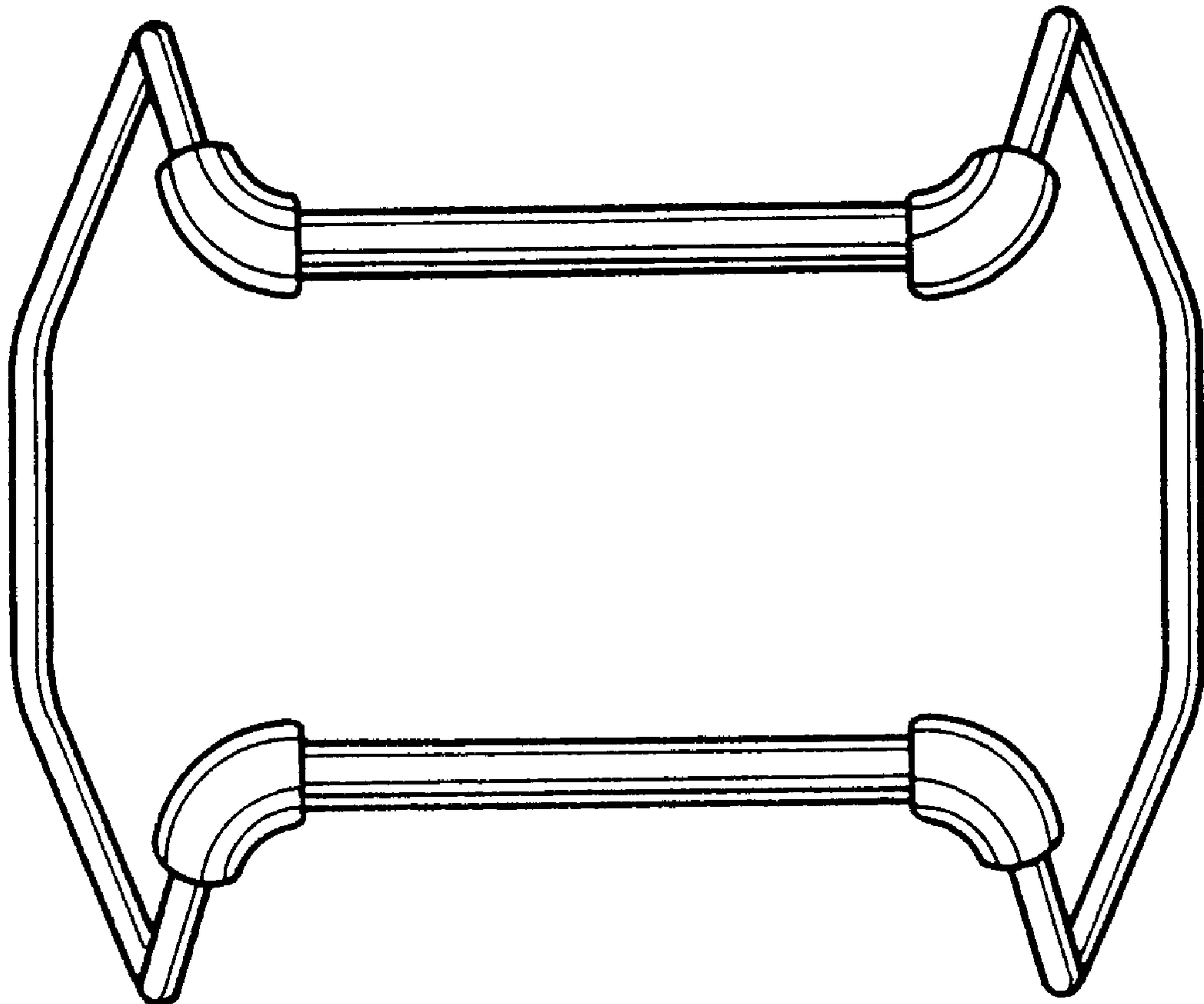

FIG. 1

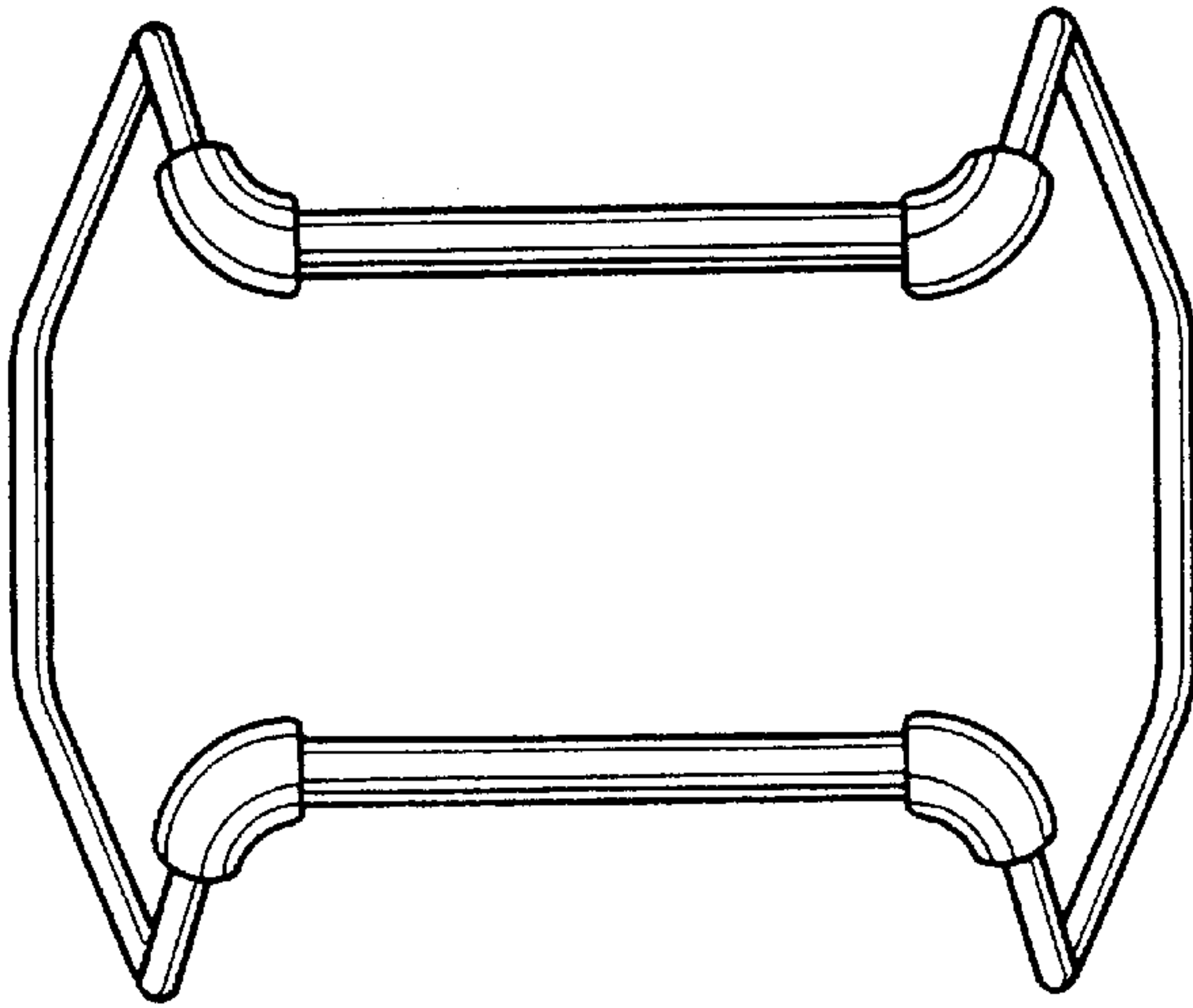

FIG. 2

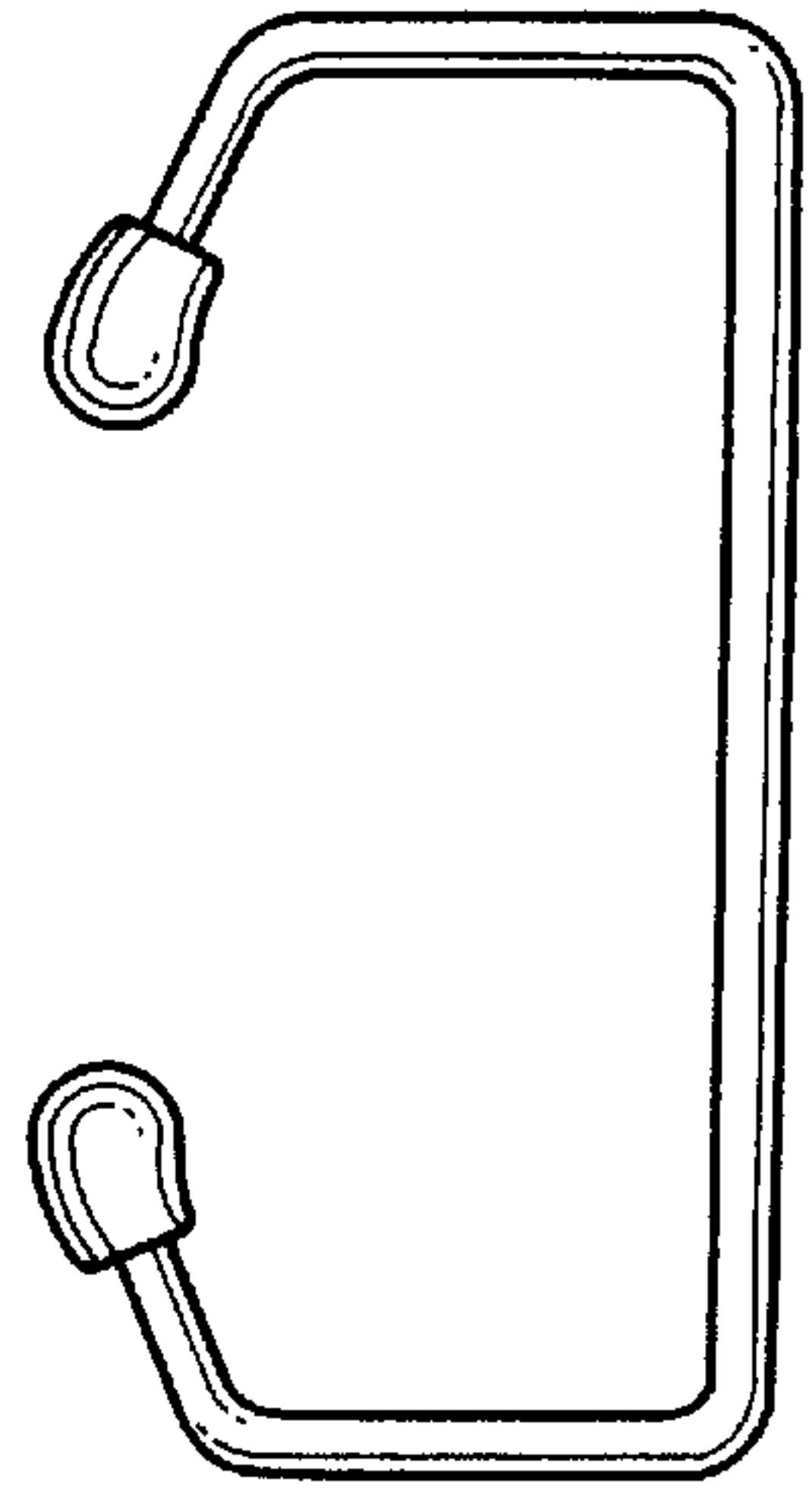

FIG. 4



FIG. 3

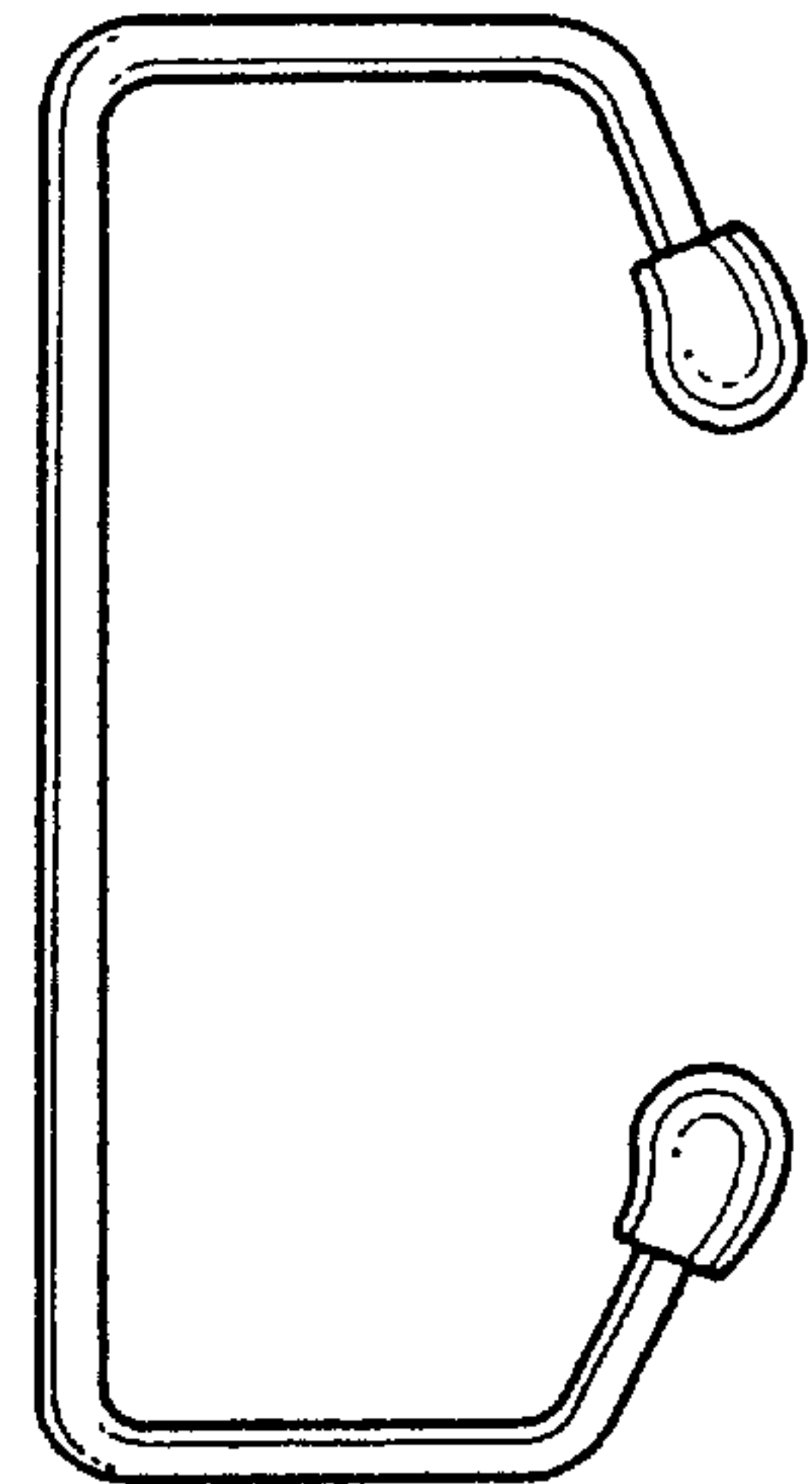

FIG. 5

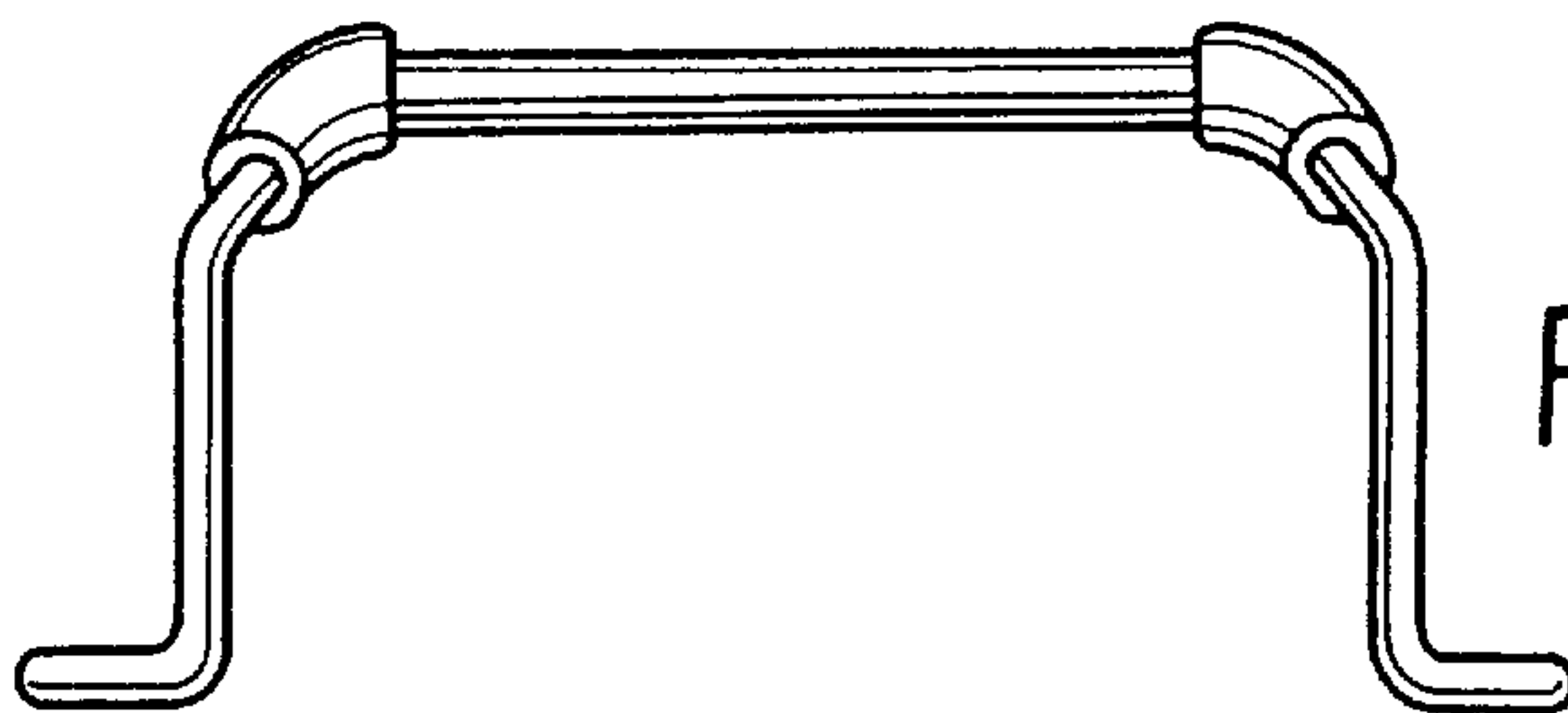

FIG. 6

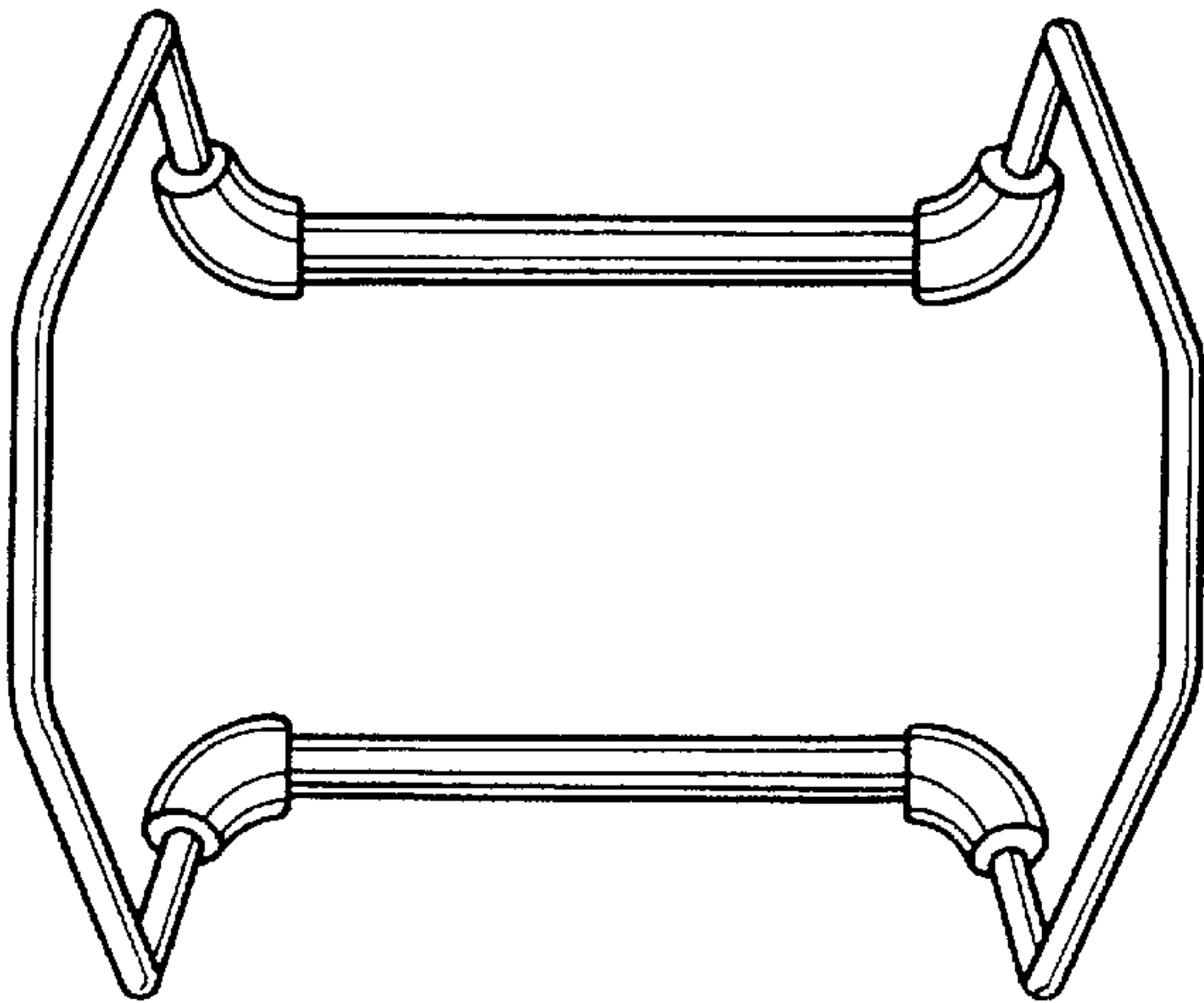

FIG. 8

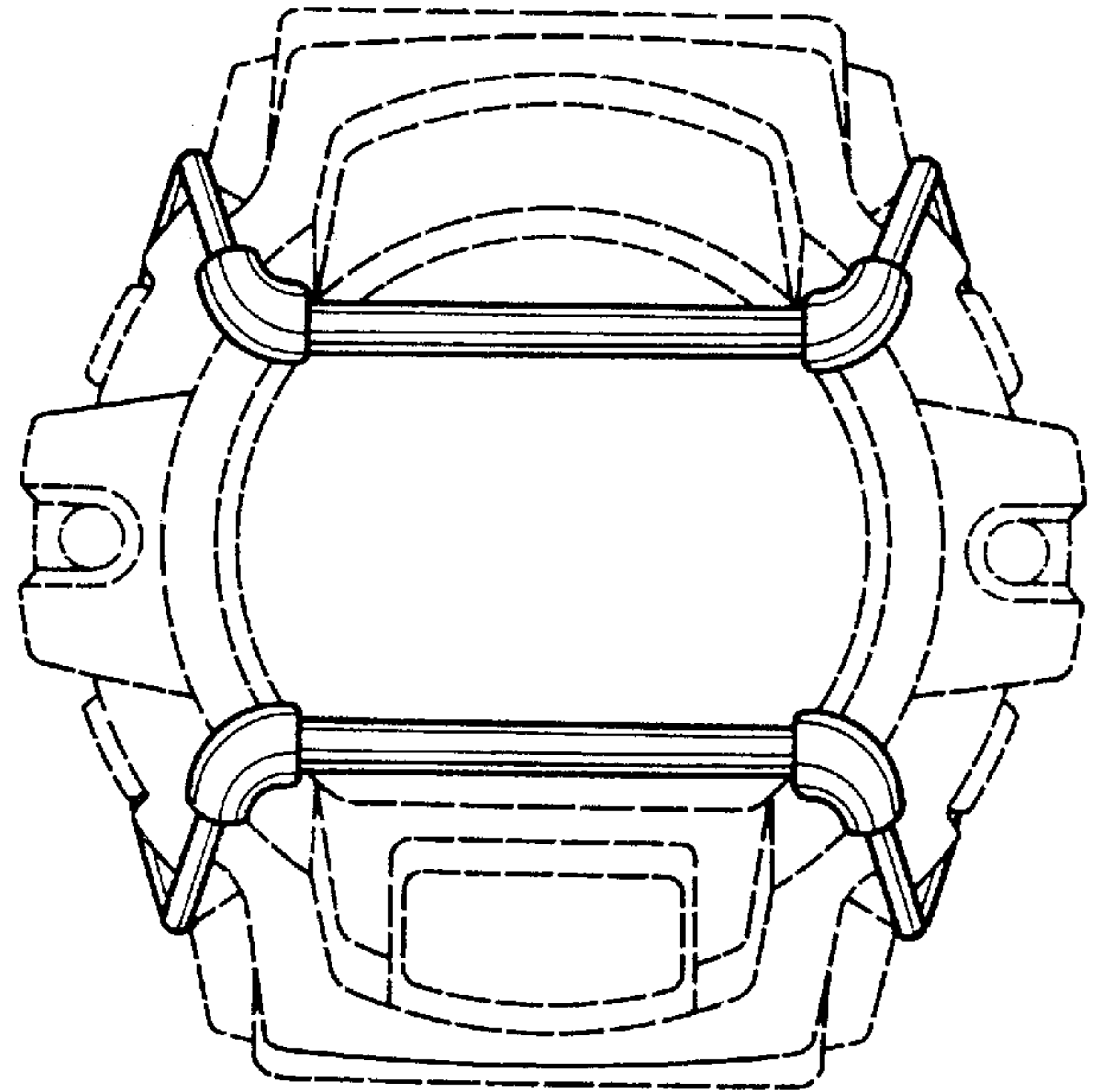

FIG. 7

