



US00D438758S

(12) **United States Design Patent**
Tal et al.

(10) **Patent No.: US D438,758 S**

(45) **Date of Patent: ** Mar. 13, 2001**

(54) **CUP**

(75) Inventors: **Elisha Tal**, Macabin (IL); **Markus Diebel**, San Francisco, CA (US); **Patrick Gilmore**, Memphis, TN (US); **Adriana Colombo-Spitzenberger**, New Fairfield, CT (US); **Chak Lam Chung**, Fremont; **Joseph W. Yang**, Castro Valley, both of CA (US)

(73) Assignee: **PepsiCo, Inc.**, Purchase, NY (US)

(**) Term: **14 Years**

(21) Appl. No.: **29/120,835**

(22) Filed: **Mar. 28, 2000**

Related U.S. Application Data

(60) Division of application No. 29/091,992, filed on Aug. 10, 1998, now Pat. No. Des. 427,852, which is a continuation-in-part of application No. 29/085,393, filed on Mar. 23, 1998, now abandoned.

(51) **LOC (7) Cl.** **07-01**

(52) **U.S. Cl.** **D7/510; D7/511**

(58) **Field of Search** **D7/507, 515, 510, D7/511, 523, 419, 392.2, 392.1, 532, 536, 534, 605, 622; D9/447, 445, 446; 220/703, 375, 713, 715, 717, 729**

(56) **References Cited**

U.S. PATENT DOCUMENTS

D. 272,793 * 2/1984 Appel et al. D7/510

(List continued on next page.)

Primary Examiner—M. N. Pandozzi

(74) *Attorney, Agent, or Firm*—Fitzpatrick, Cella, Harper & Scinto

(57) **CLAIM**

The ornamental design for a cup, as shown and described.

DESCRIPTION

FIG. 1 is a perspective view of the cup design of the present invention;

FIG. 2 is an elevational view;
FIG. 3 is an elevational view taken 90 degrees from the elevational view of FIG. 2;
FIG. 4 is an elevational view taken 180 degrees from the elevational view of FIG. 2;
FIG. 5 is an elevational view taken 180 degrees from the elevational view of FIG. 3;
FIG. 6 is a top plan view;
FIG. 7 is a bottom plan view;
FIG. 8 is a perspective view of another embodiment of the design of the present invention;
FIG. 9 is an elevational view of the embodiment of FIG. 8;
FIG. 10 is an elevational view taken 90 degrees from the view of FIG. 9;
FIG. 11 is an elevational view taken 180 degrees from the view of FIG. 10;
FIG. 12 is an elevational view taken 180 degrees from the view of FIG. 9;
FIG. 13 is a bottom plan view of the embodiment of FIG. 8;
FIG. 14 is a top plan view of the embodiment of FIG. 8;
FIG. 15 is a perspective view of another embodiment of the design of the present invention;
FIG. 16 is an elevational view of the embodiment of FIG. 15;
FIG. 17 is an elevational view taken 90 degrees from the view of FIG. 16;
FIG. 18 is an elevational view taken 180 degrees from the view of FIG. 17;
FIG. 19 is an elevational view taken 180 degrees from the view of FIG. 16;
FIG. 20 is a top plan view of the embodiment of FIG. 15;
FIG. 21 is a bottom plan view of the embodiment of FIG. 15;
FIG. 22 is a perspective view of another embodiment of the design of the present invention;
FIG. 23 is an elevational view of the embodiment of FIG. 22;
FIG. 24 is an elevational view taken 90 degrees from the view of FIG. 23;
FIG. 25 is an elevational view taken 180 degrees from the view of FIG. 23;
FIG. 26 is an elevational view taken 180 degrees from the view of FIG. 24;
FIG. 27 is a top plan view taken 180 degrees from the view of FIG. 22; and,
FIG. 28 is a bottom plan view of the embodiment of FIG. 22.

1 Claim, 16 Drawing Sheets

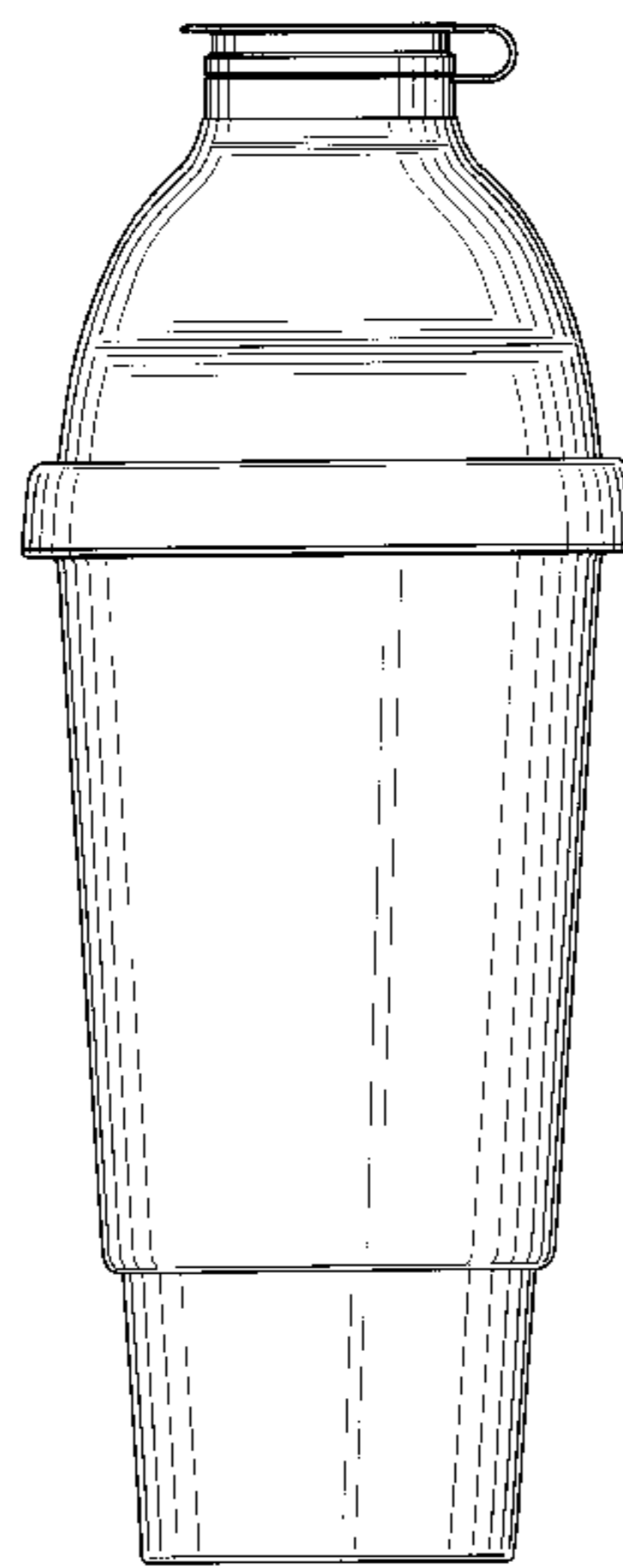
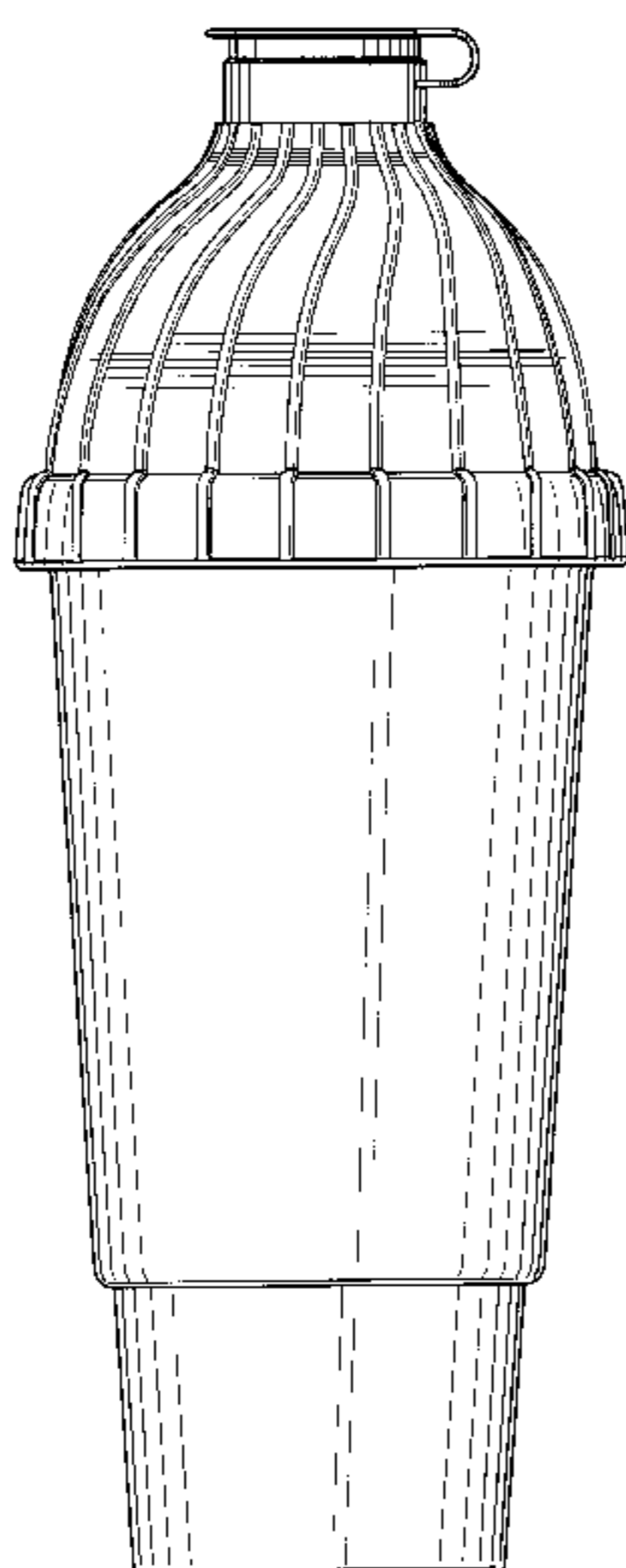

US D438,758 S

Page 2

U.S. PATENT DOCUMENTS

D. 289,720	*	5/1987	Maher	D7/396.2
D. 336,429	*	6/1993	Petoskey	D9/447
D. 342,418	*	12/1993	Stymiest	D7/396.2
D. 358,294	*	5/1995	Letica	D7/392.1
D. 359,417	*	6/1995	Chen	D7/510
D. 360,579	*	7/1995	Accarias	D9/447
D. 364,810	*	12/1995	Meisner	D9/446
D. 367,402	*	2/1996	Bates et al.	D7/520
D. 379,738	*	6/1997	Liming et al.	D7/511
D. 382,174	*	8/1997	Grimm	D7/510
D. 382,247	*	8/1997	Lindberg	D12/403
D. 383,038	*	9/1997	Willbrandt	D7/531
D. 398,851	*	9/1998	Gaiser et al.	D9/447
D. 404,646	*	1/1999	Black, Sr. et al.	D9/446
4,123,225	*	10/1978	Jones et al.	422/98
4,448,316	*	5/1984	Hiroshige	215/388
4,508,235	*	4/1985	Steele et al.	215/307
5,312,014	*	5/1994	Hamlin	.	
5,871,118	*	2/1999	Franzese	220/717

* cited by examiner

FIG. 1

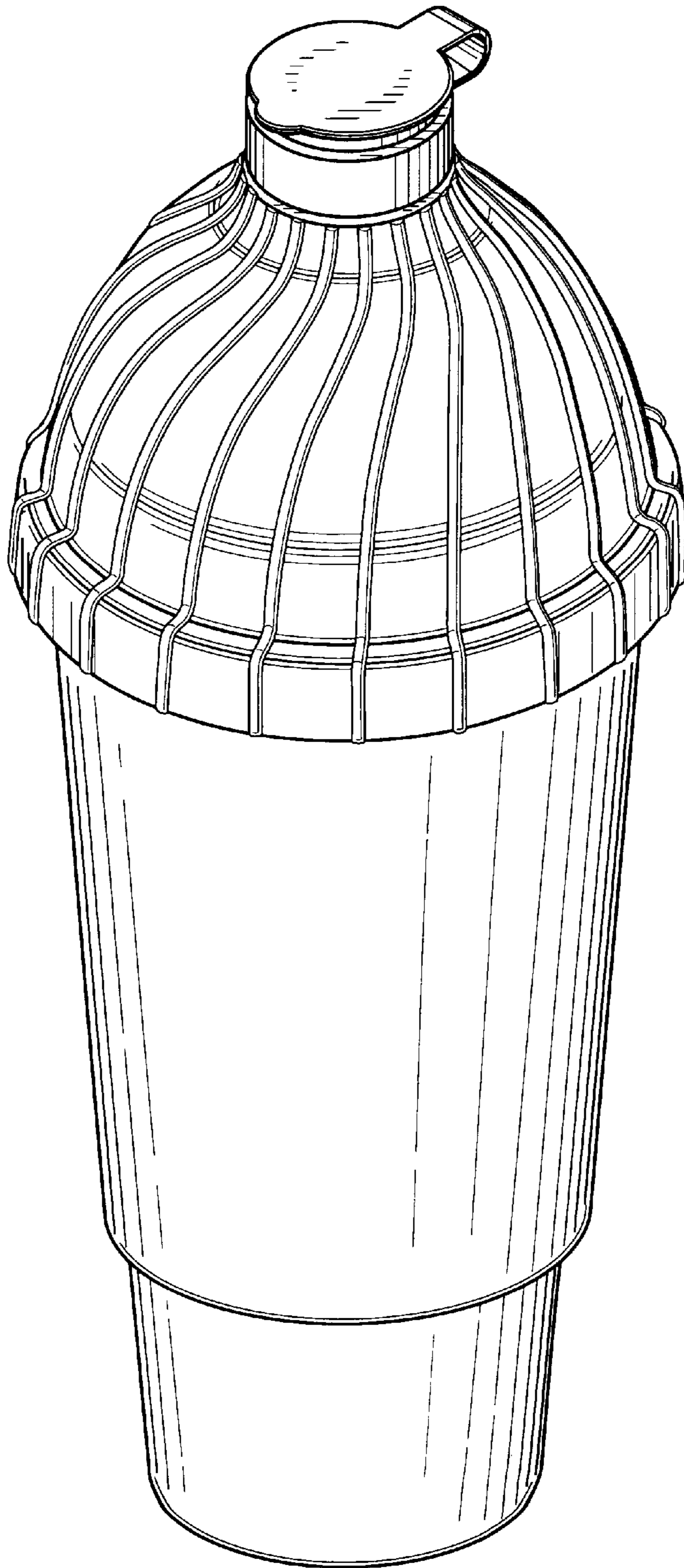

FIG. 2

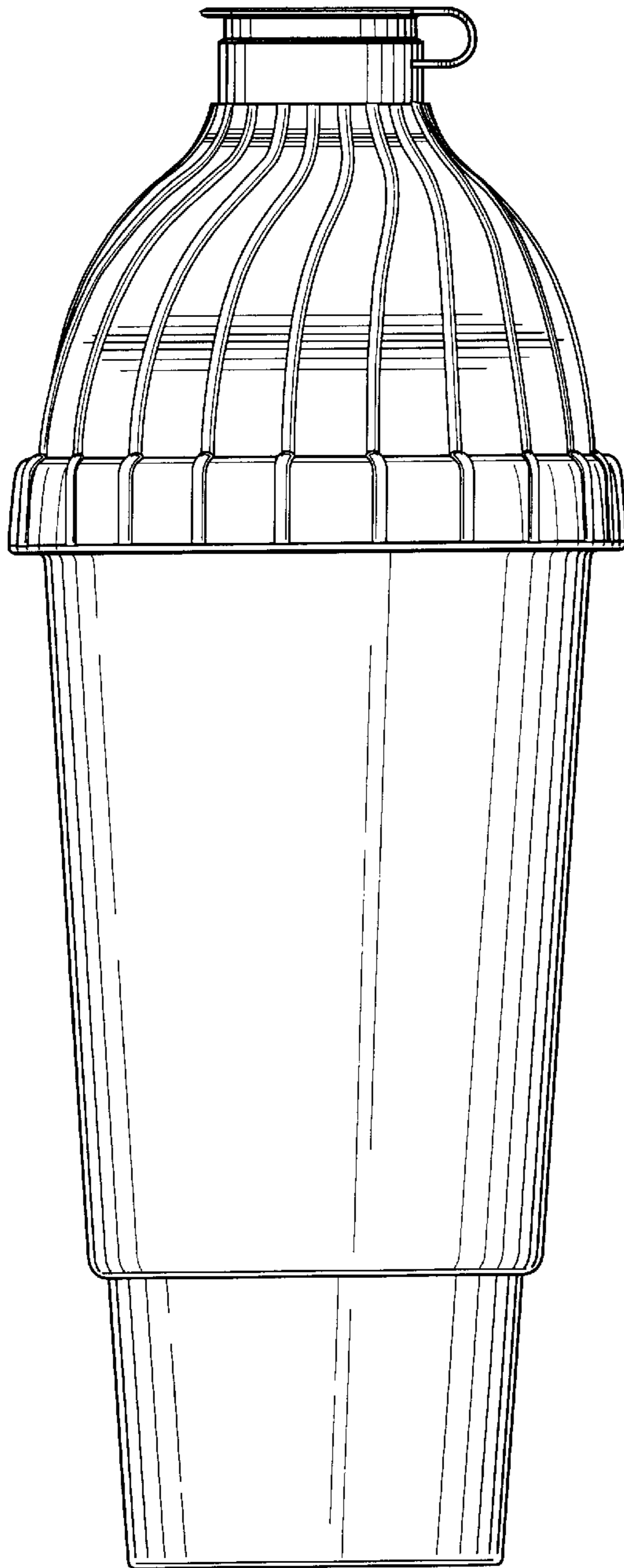

FIG. 3

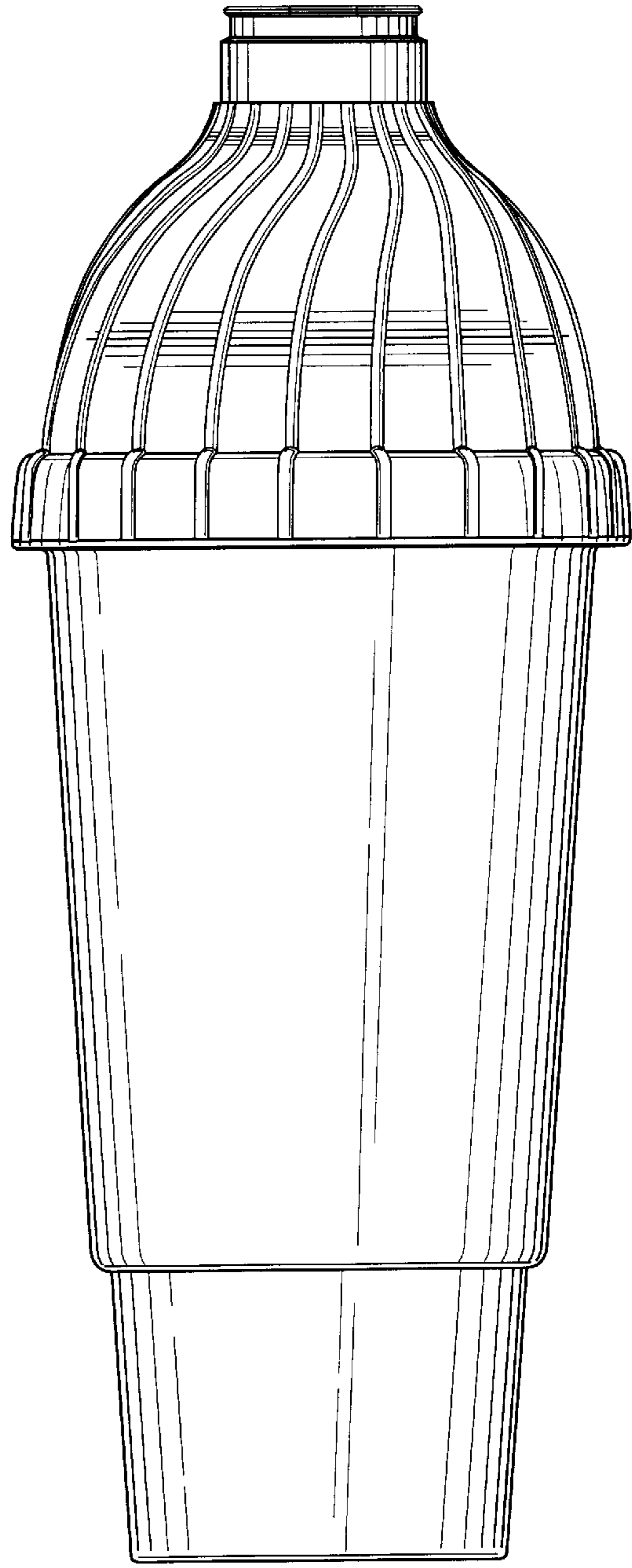

FIG. 4

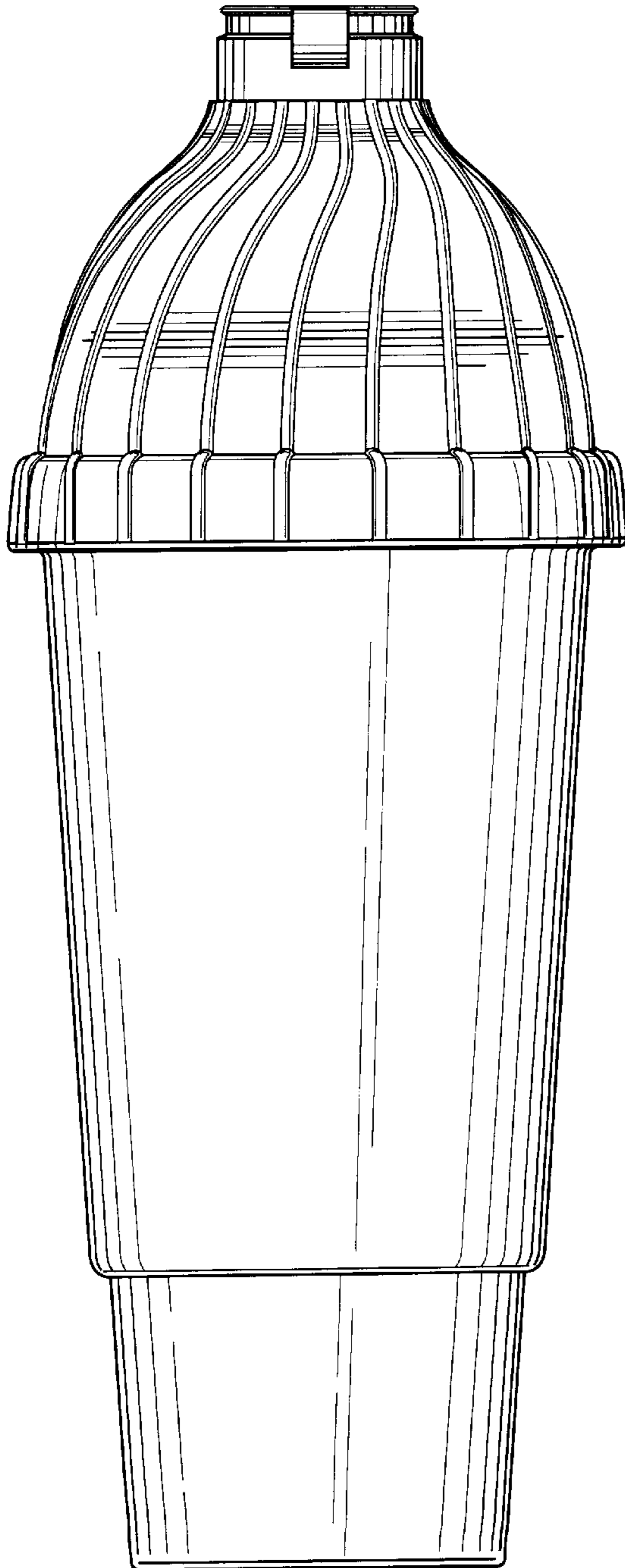

FIG. 5

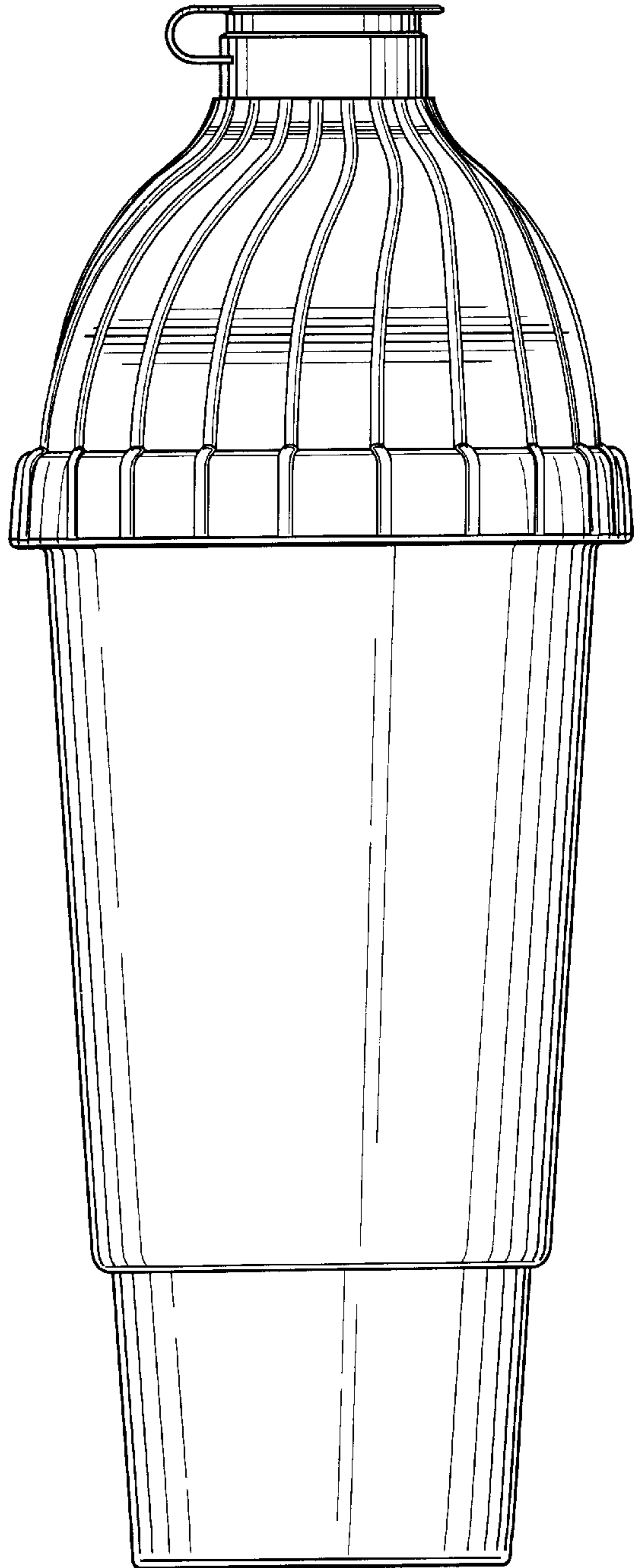

FIG. 6

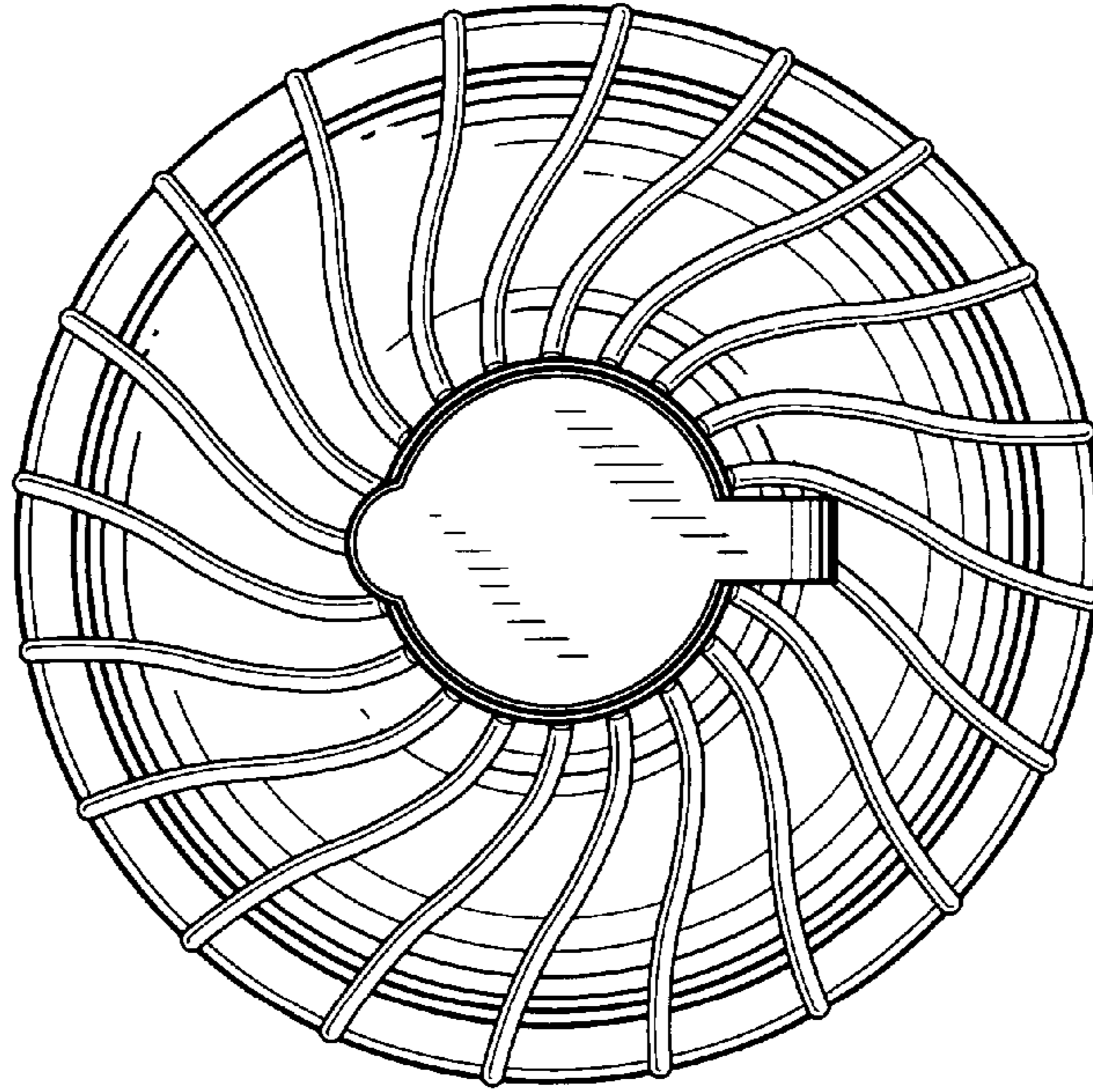

FIG. 7

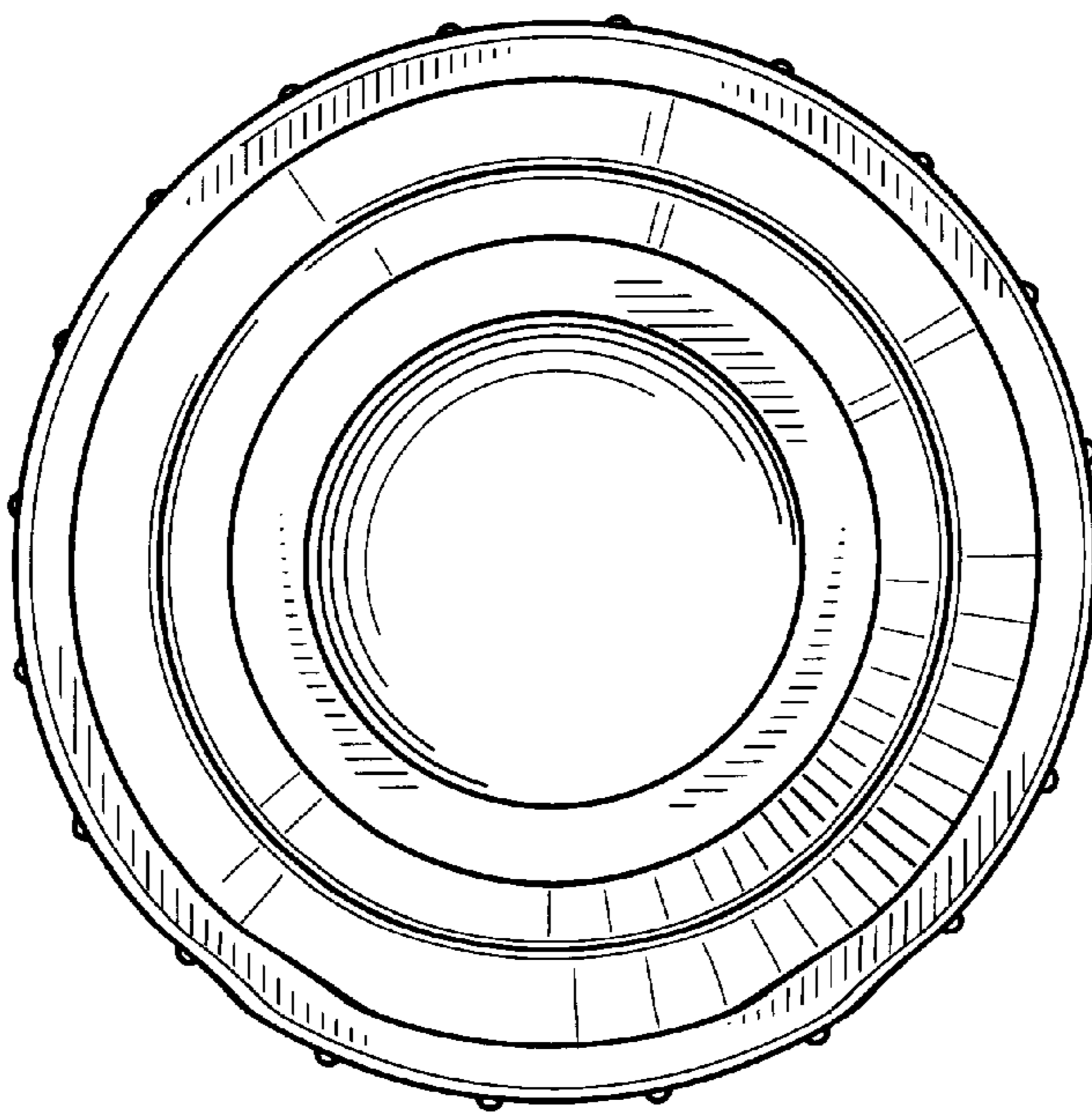

FIG. 8

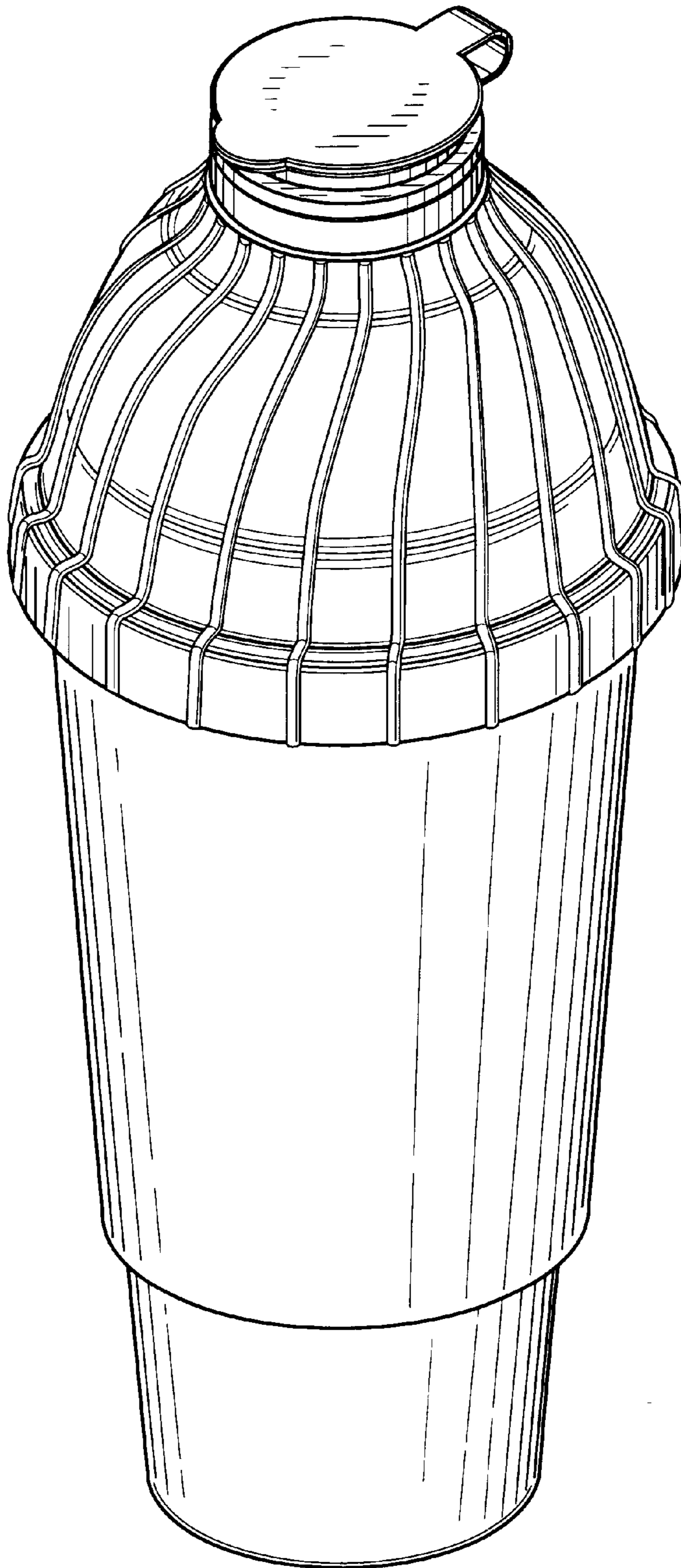

FIG. 9

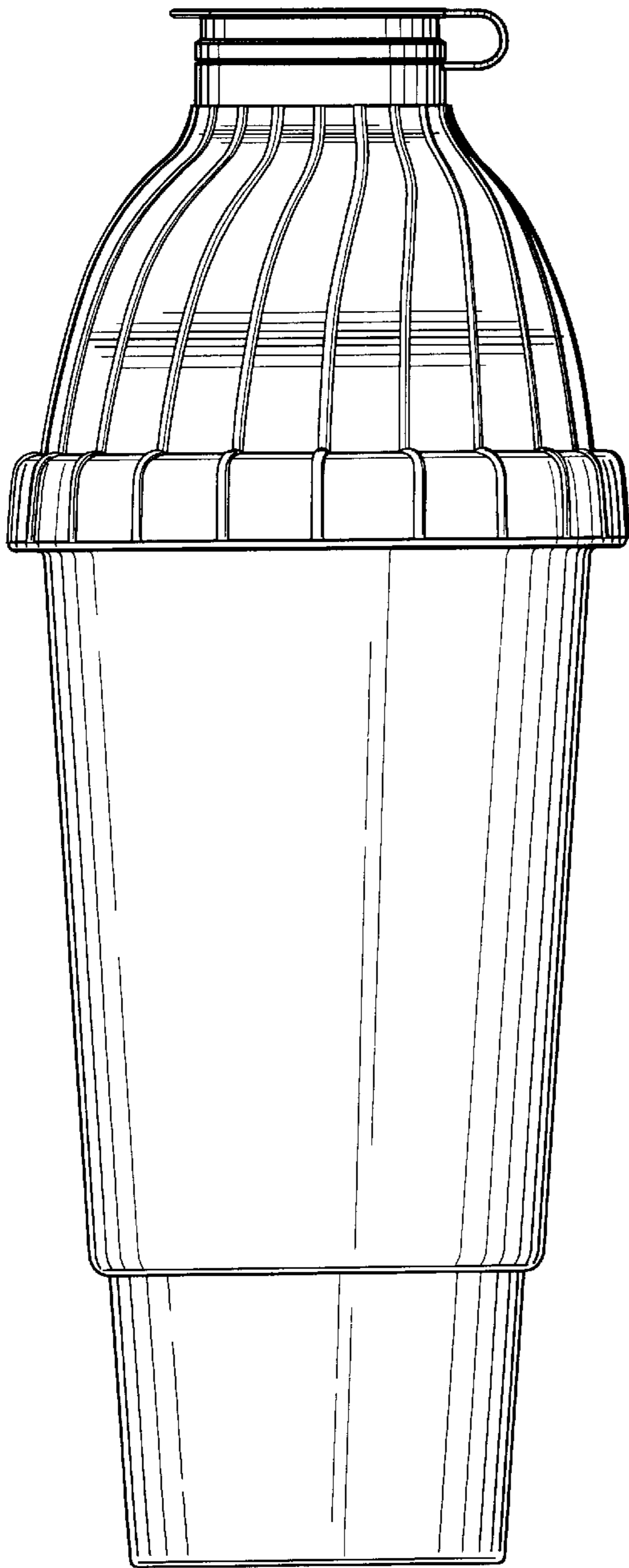

FIG. 10

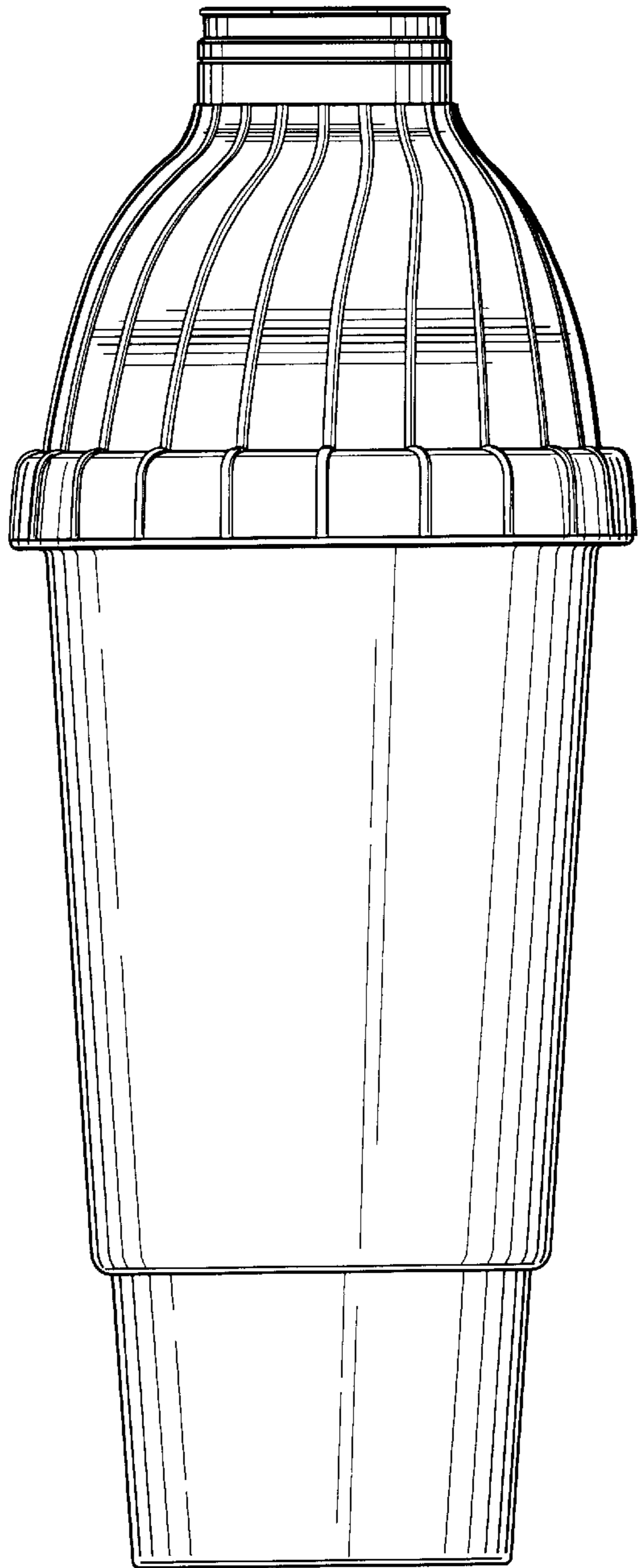

FIG. 11

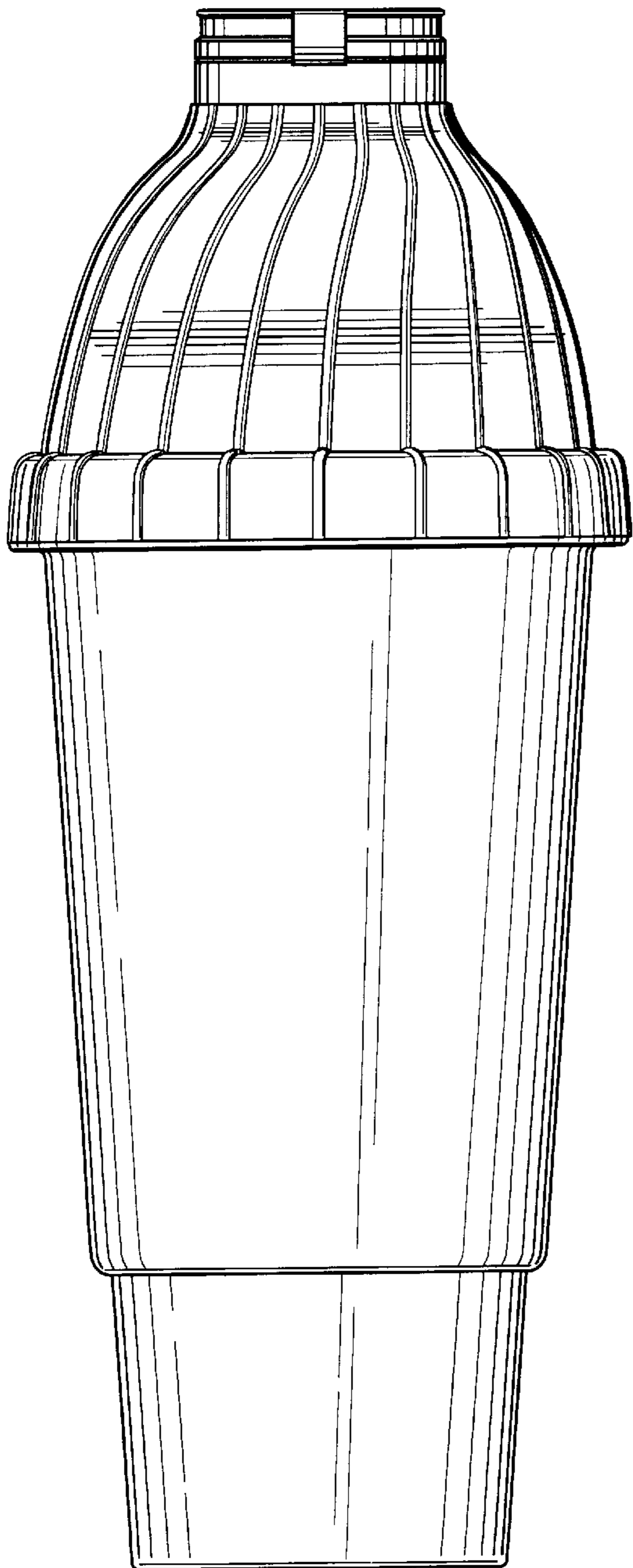

FIG. 12

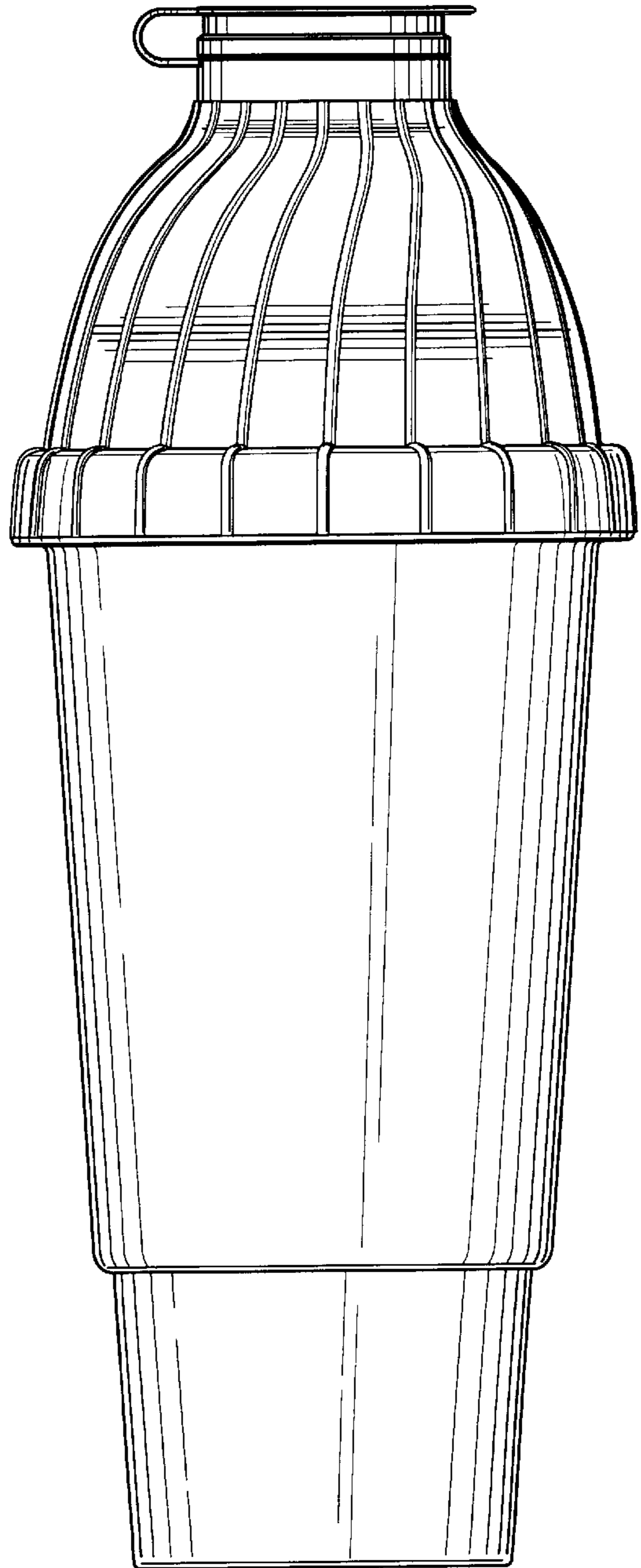

FIG. 13

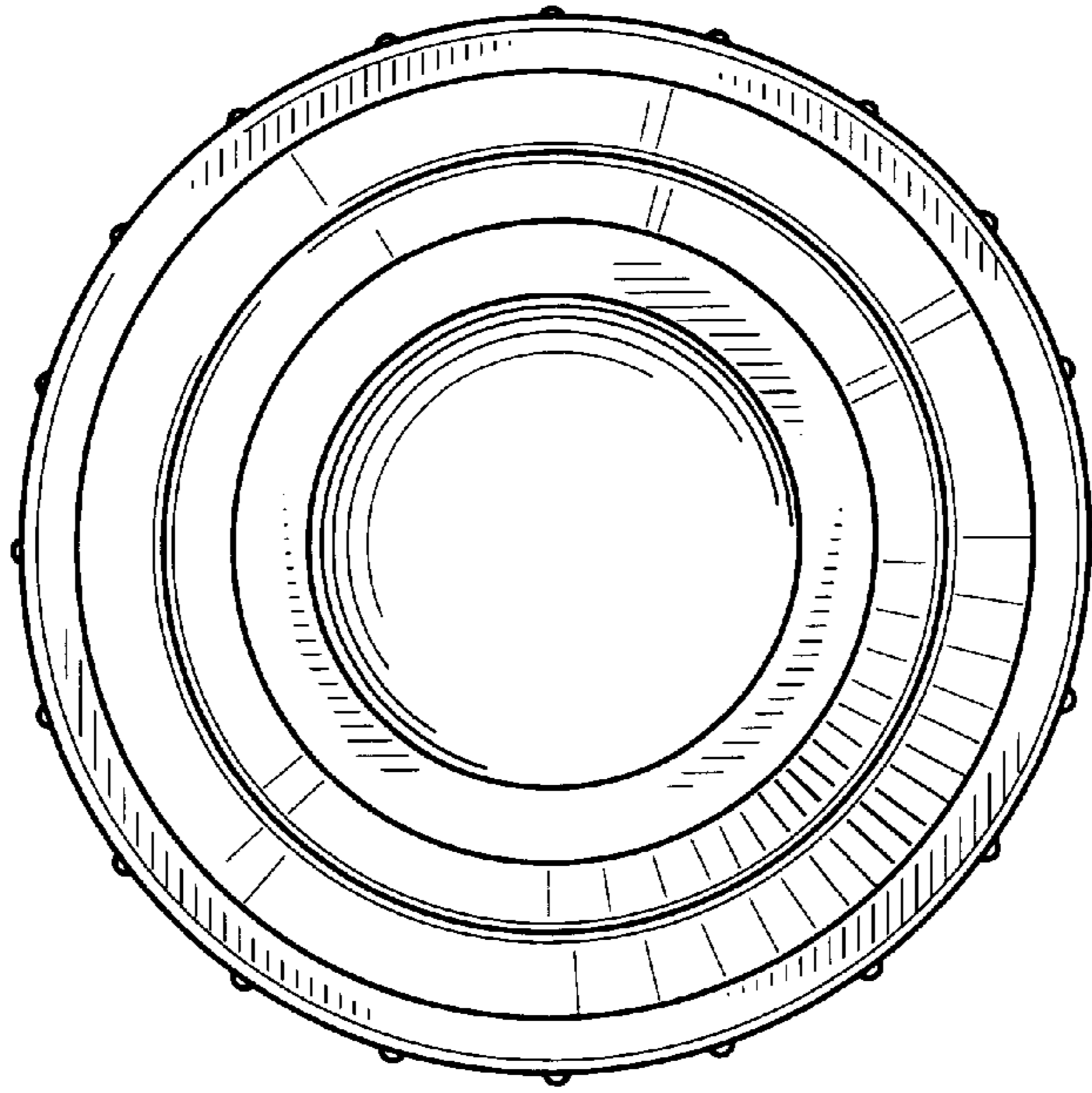

FIG. 14

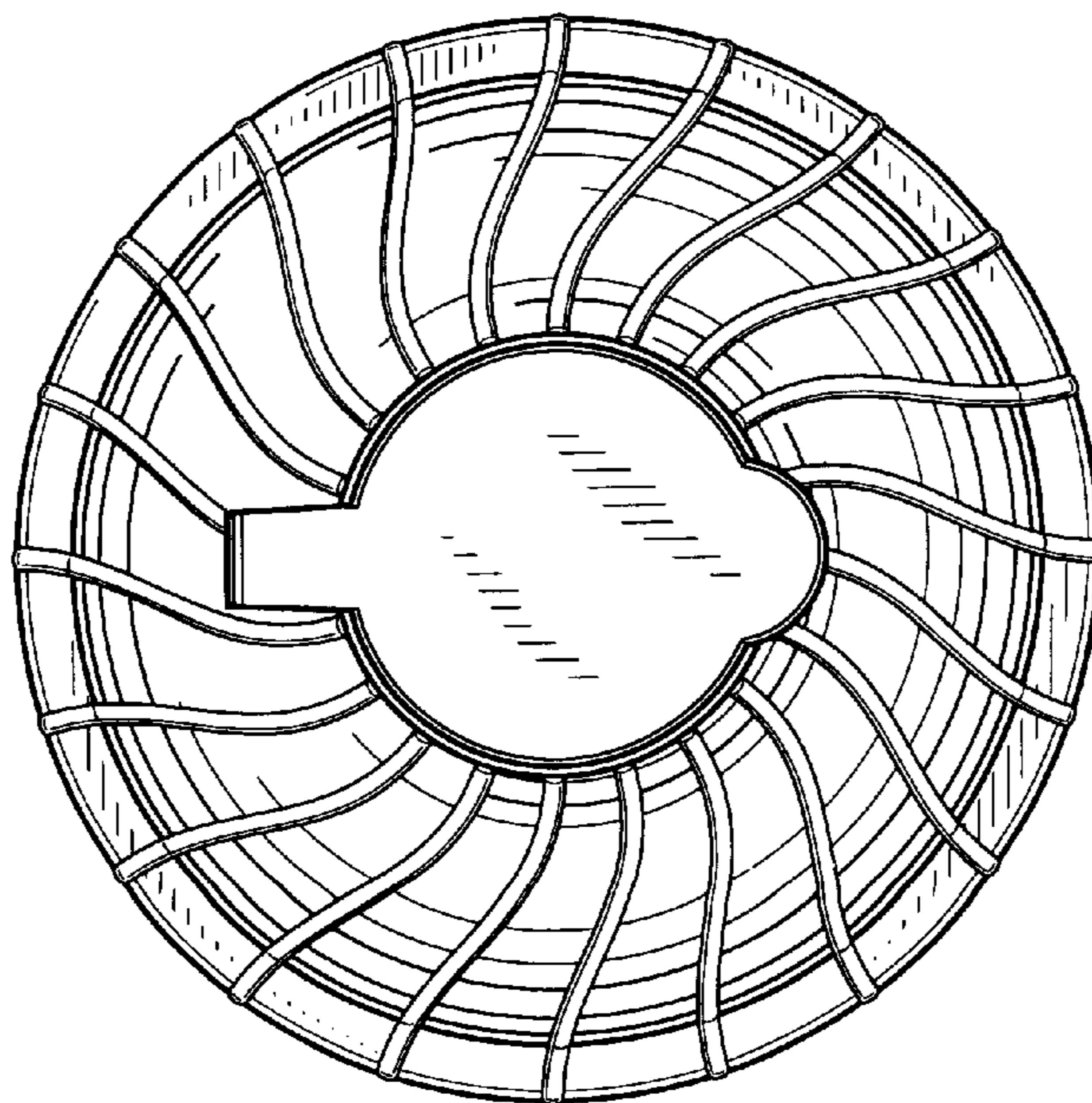

FIG. 15

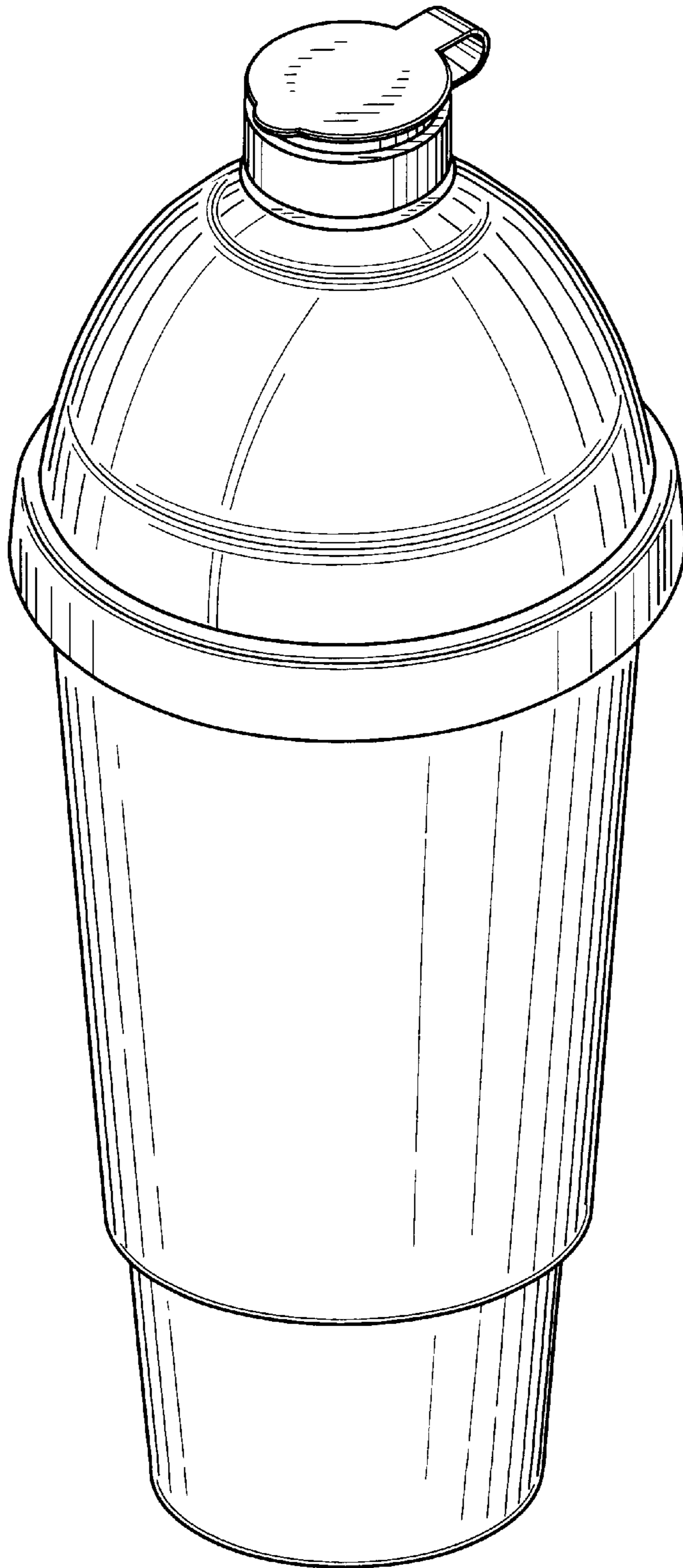

FIG. 16

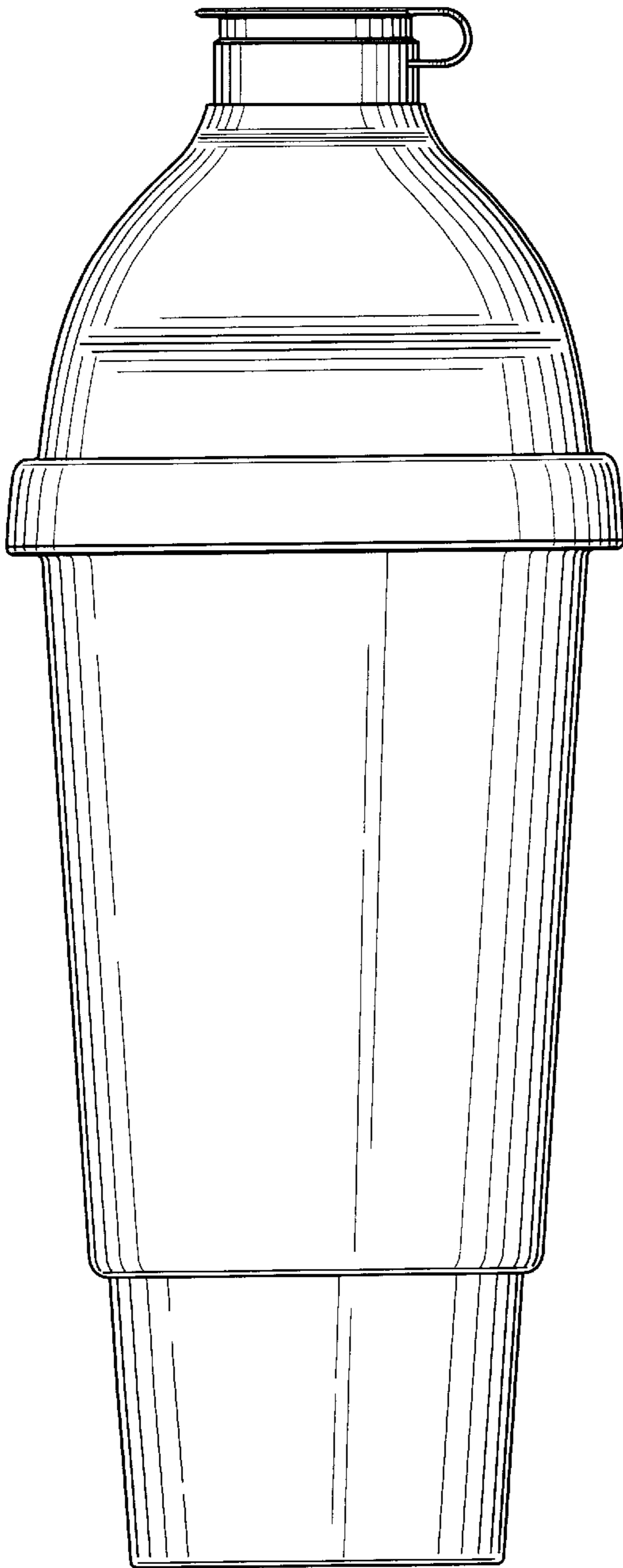

FIG. 17

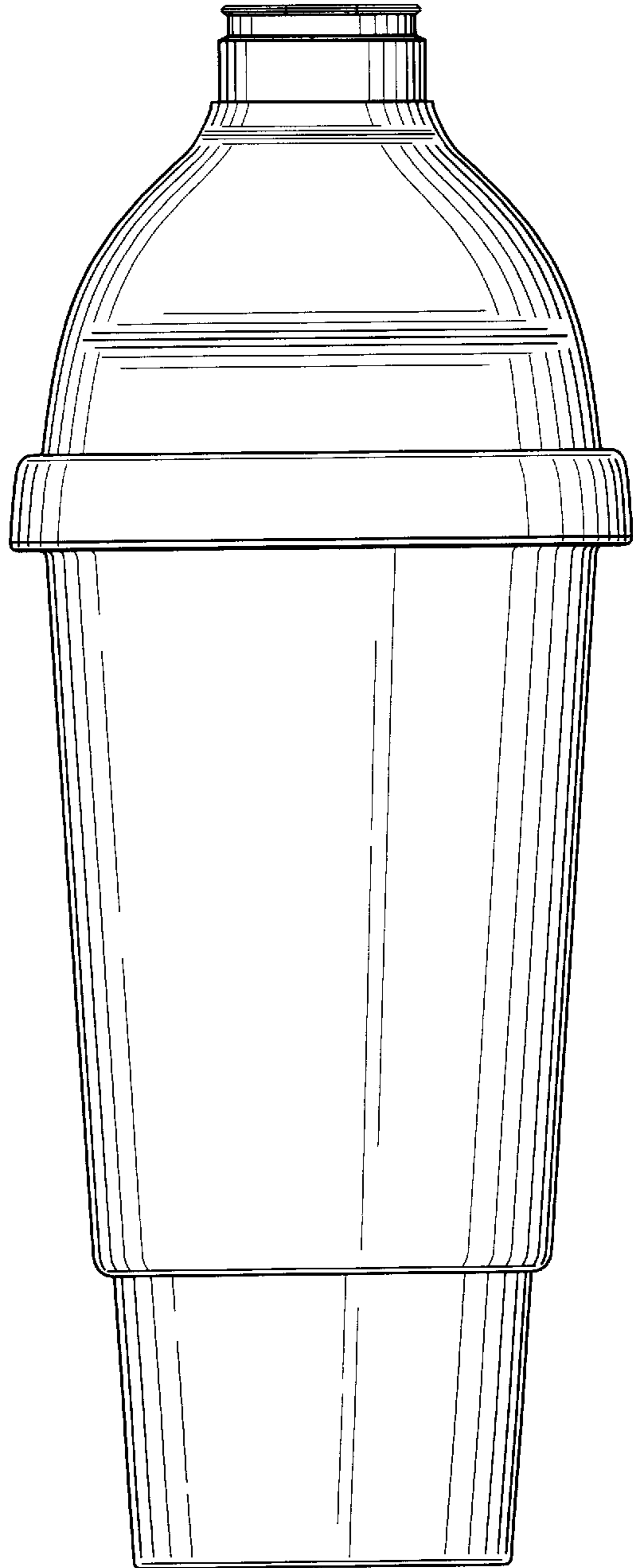

FIG. 18

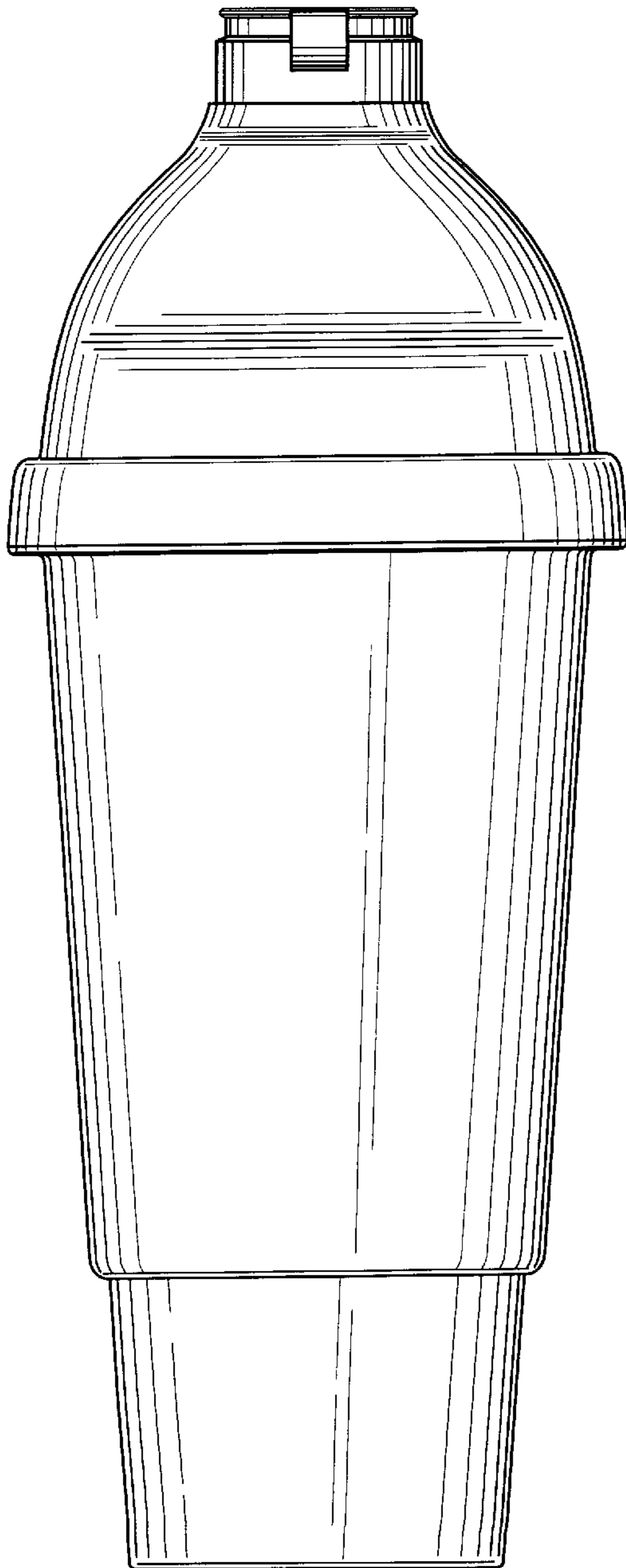

FIG. 19

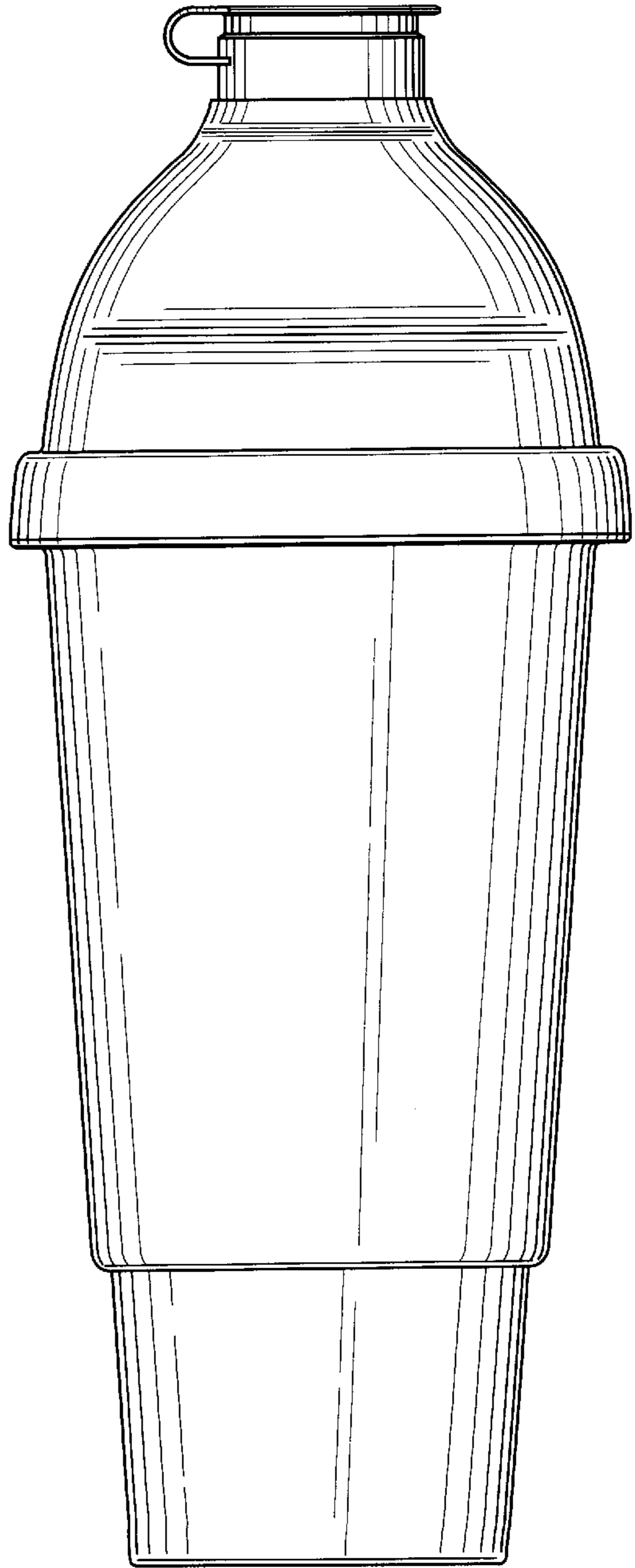

FIG. 20

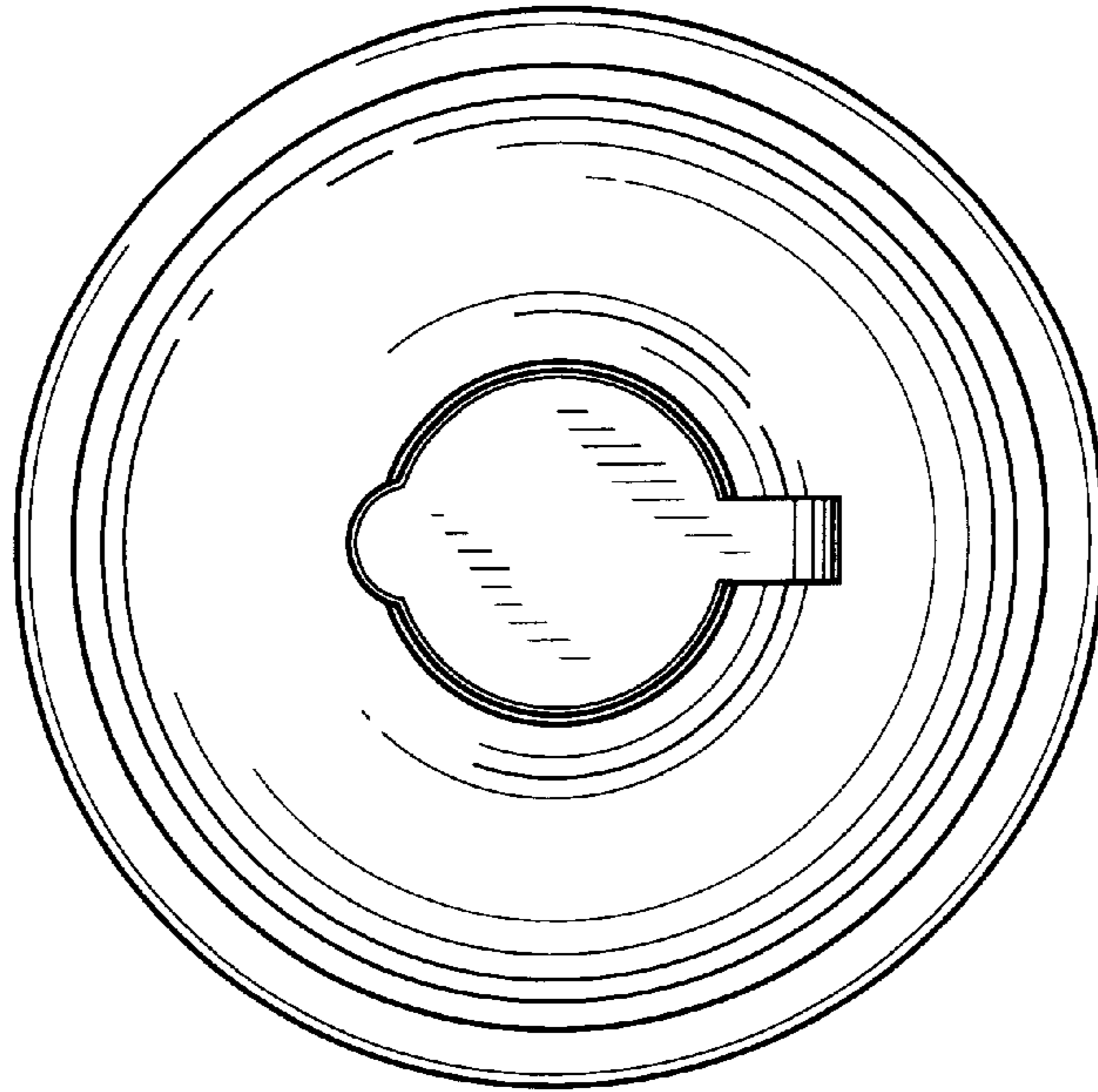

FIG. 21

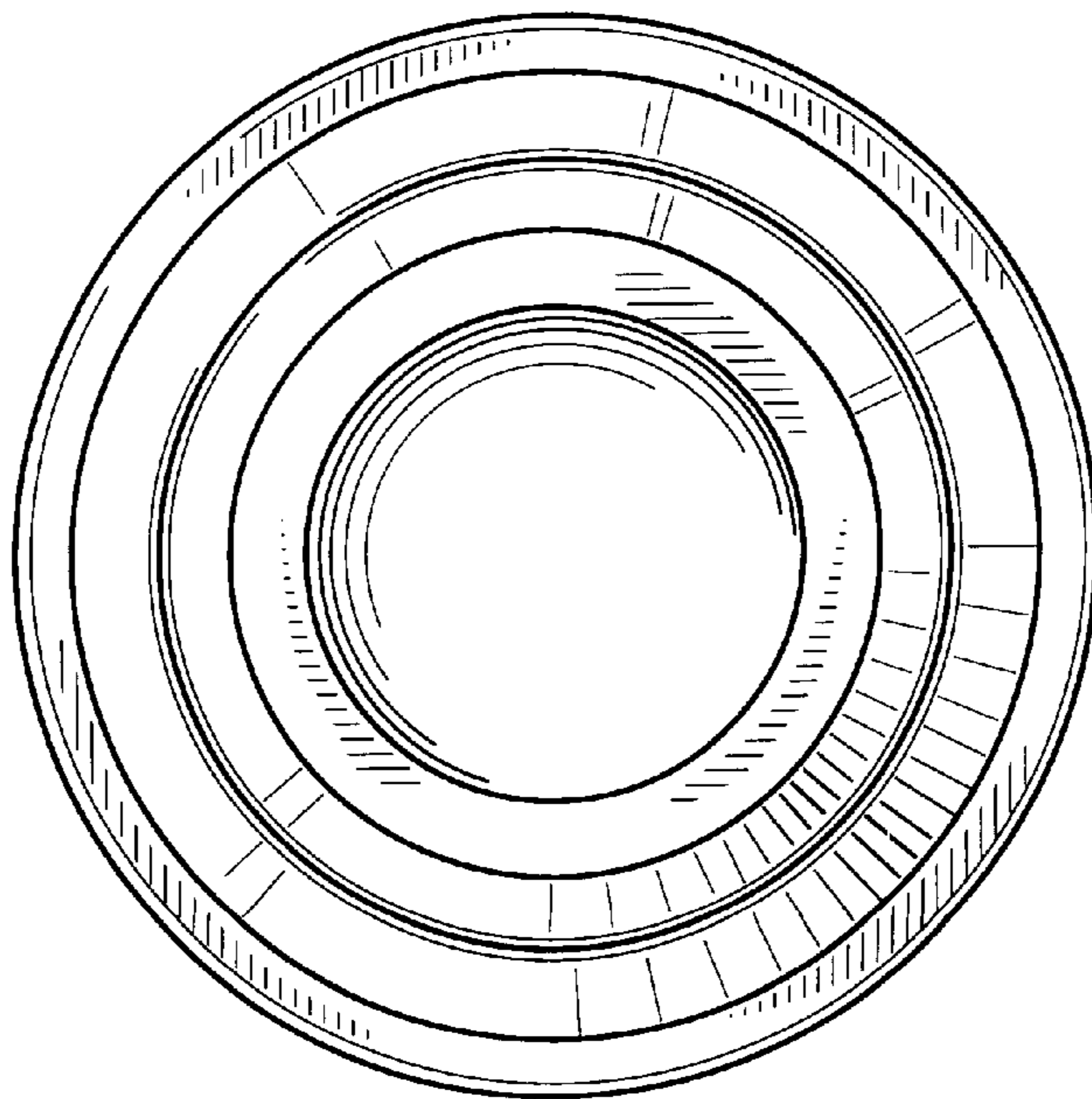

FIG. 22

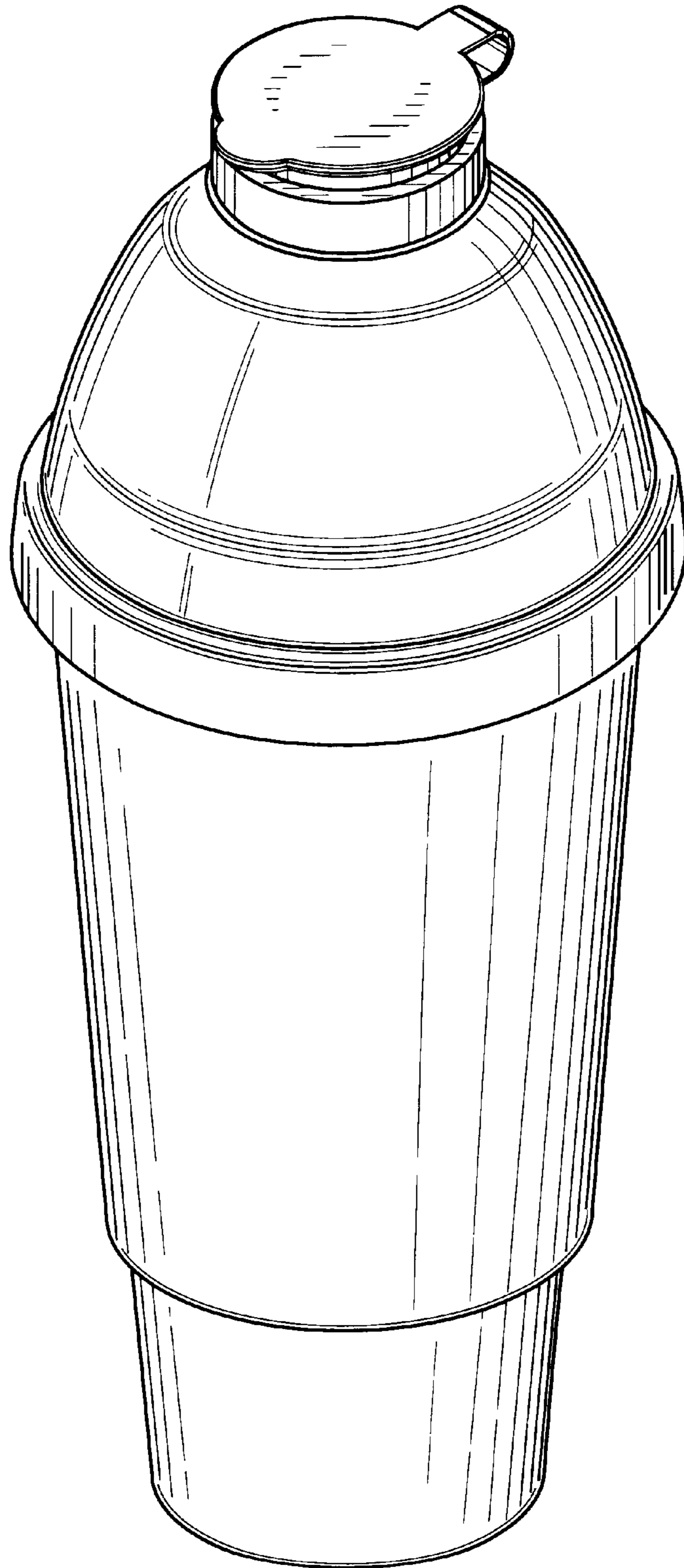

FIG. 23

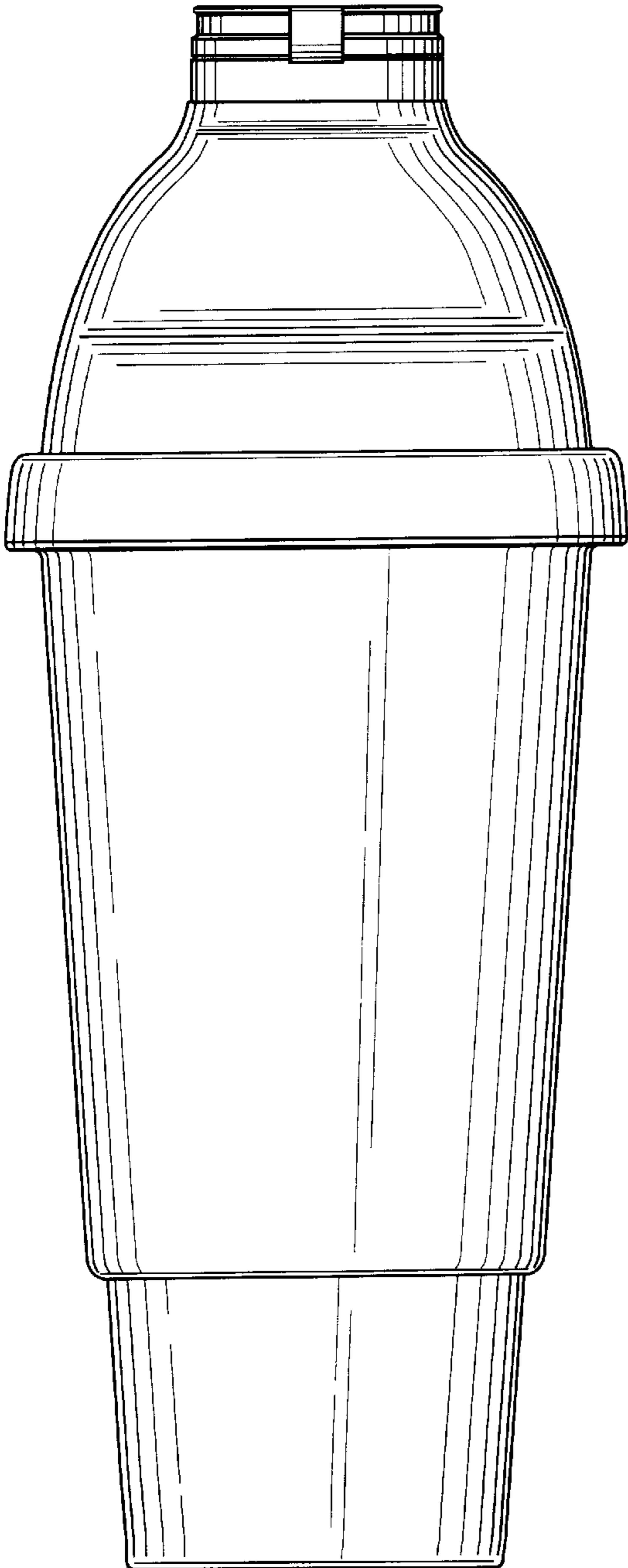

FIG. 24

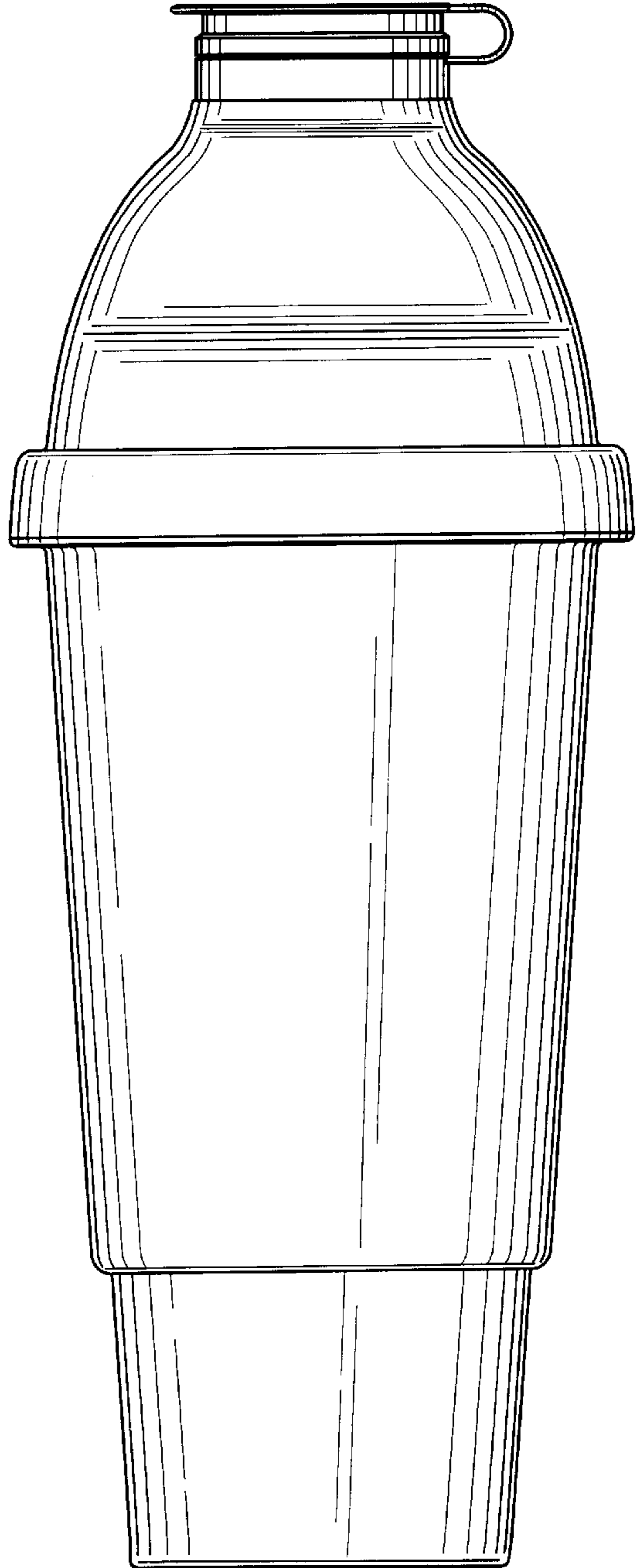

FIG. 25

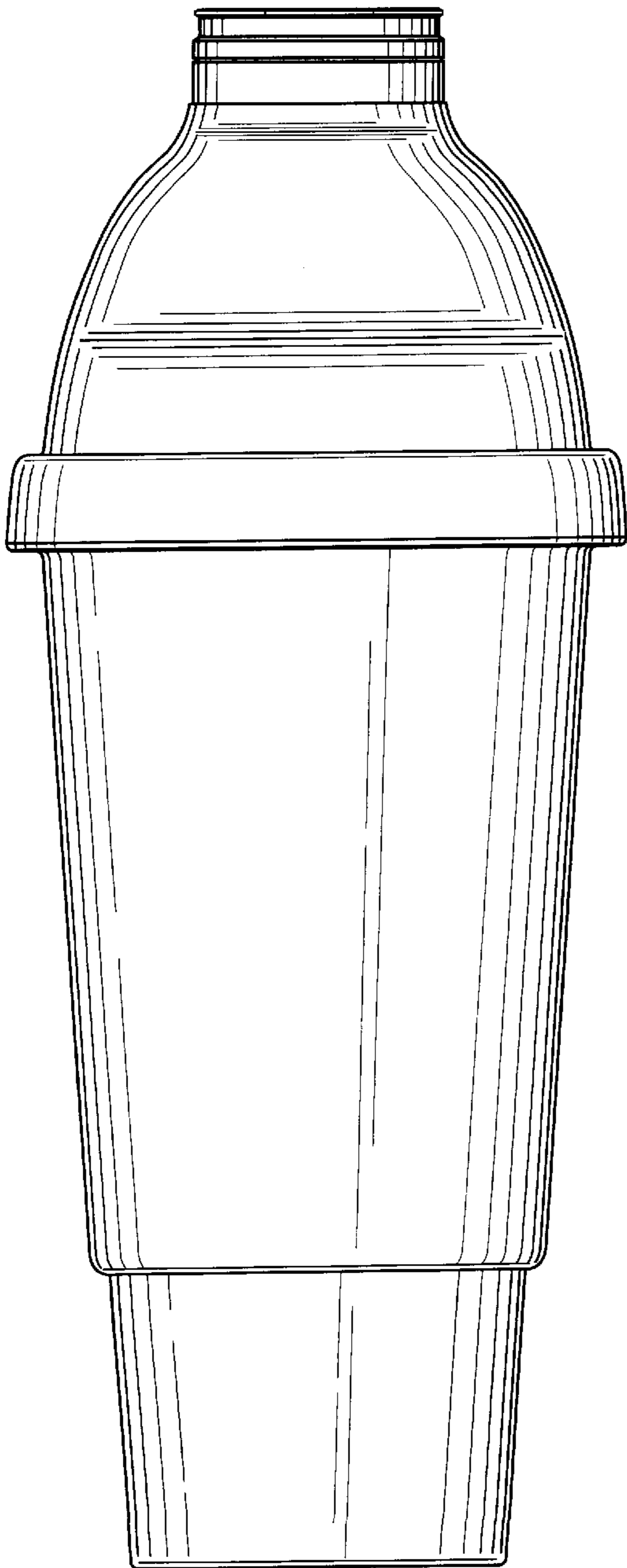

FIG. 26

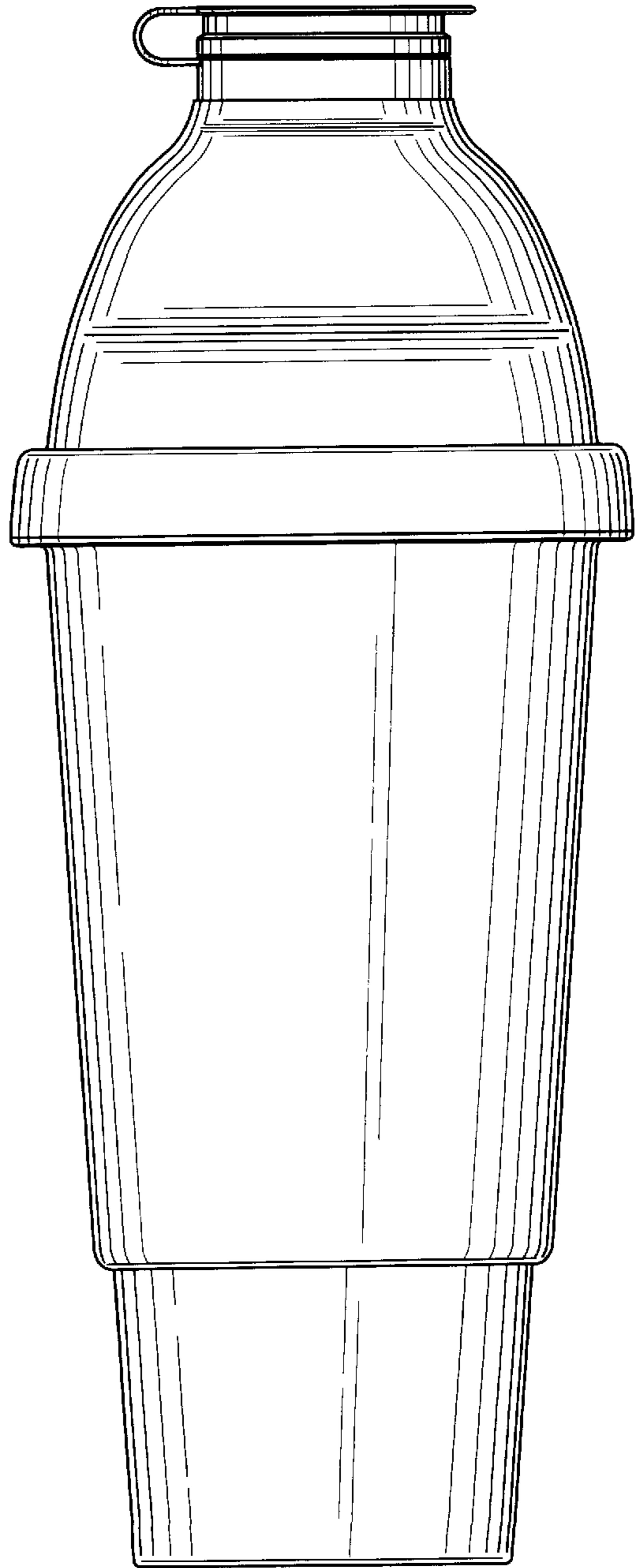

FIG. 27

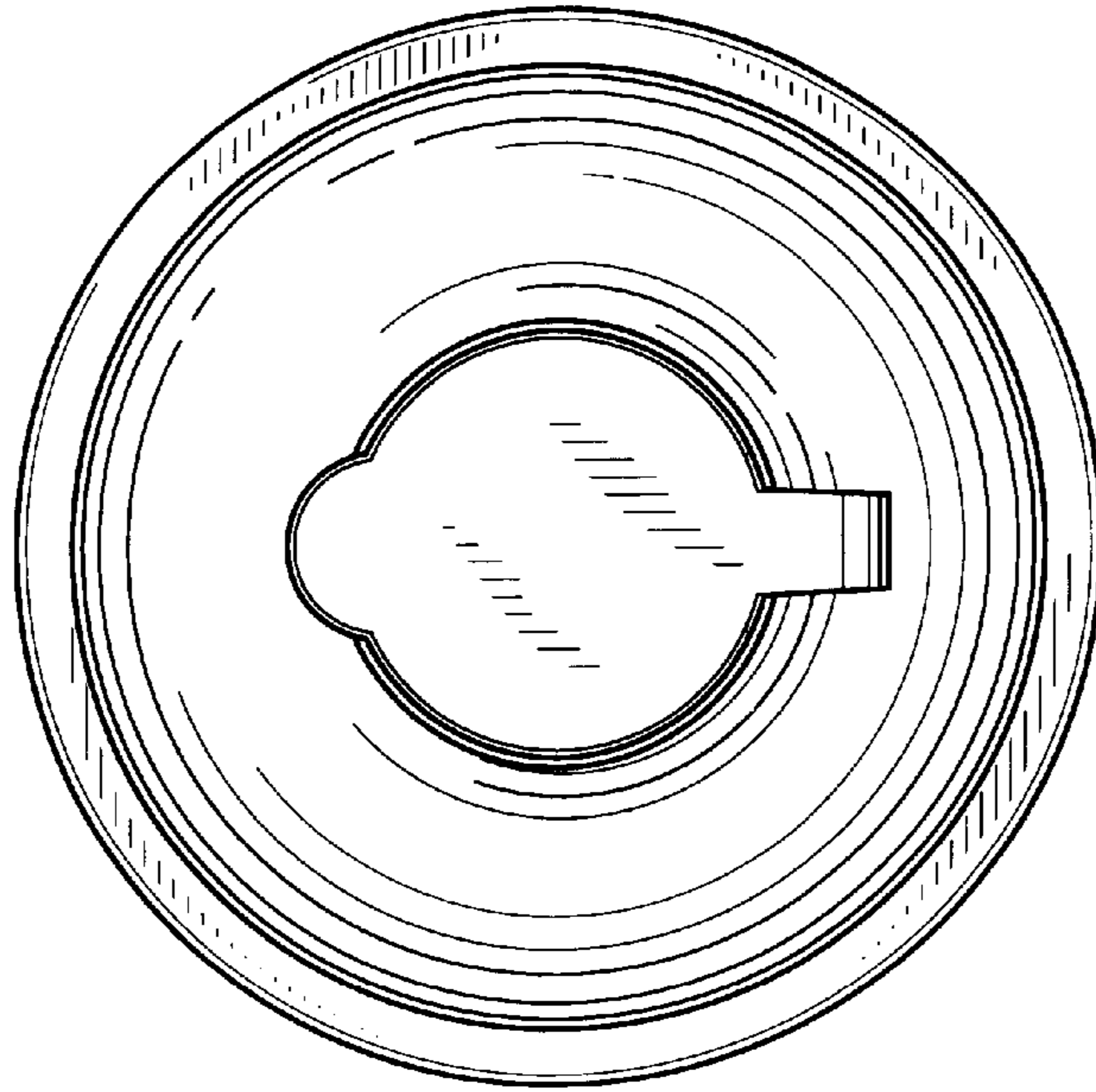

FIG. 28

