



US00D438622S

(12) **United States Design Patent**
Chang

(10) **Patent No.:** **US D438,622 S**

(45) **Date of Patent:** **** Mar. 6, 2001**

(54) **TOOTH WHITENING DEVICE**

(75) Inventor: **Shu Kun Chang**, Evanston, IL (US)

(73) Assignee: **BriteSmile, Inc.**, Walnut Creek, CA (US)

(**) Term: **14 Years**

(21) Appl. No.: **29/099,461**

(22) Filed: **Jan. 19, 1999**

(51) **LOC (7) Cl.** **24-02**

(52) **U.S. Cl.** **D24/176**

(58) **Field of Search** D24/152, 176,
D24/209, 210, 107, 133, 232, 177, 178,
184; 433/215, 29, 216, 217.1, 229, 80;
362/804, 183

(56) **References Cited**

U.S. PATENT DOCUMENTS

4,952,143 * 8/1990 Becker et al. 433/32
5,879,159 * 3/1999 Cipolla 433/29

* cited by examiner

Primary Examiner—Ian Simmons

(74) *Attorney, Agent, or Firm*—Kalow & Springut LLP

(57) **CLAIM**

The ornamental design for a tooth whitening device, as shown and described.

DESCRIPTION

FIG. 1 is a front perspective view of the tooth whitening device showing my new design;

FIG. 2 is a rear view thereof;

FIG. 3 is a front view thereof

FIG. 4 is a left side view thereof;

FIG. 5 is a right side view thereof;

FIG. 6 is a top plan view; and,

FIG. 7 is a front perspective view thereof, show in articulated position.

The surface or portion of the article not shown in the drawing or described in the specification forms no part of the claimed design.

1 Claim, 7 Drawing Sheets

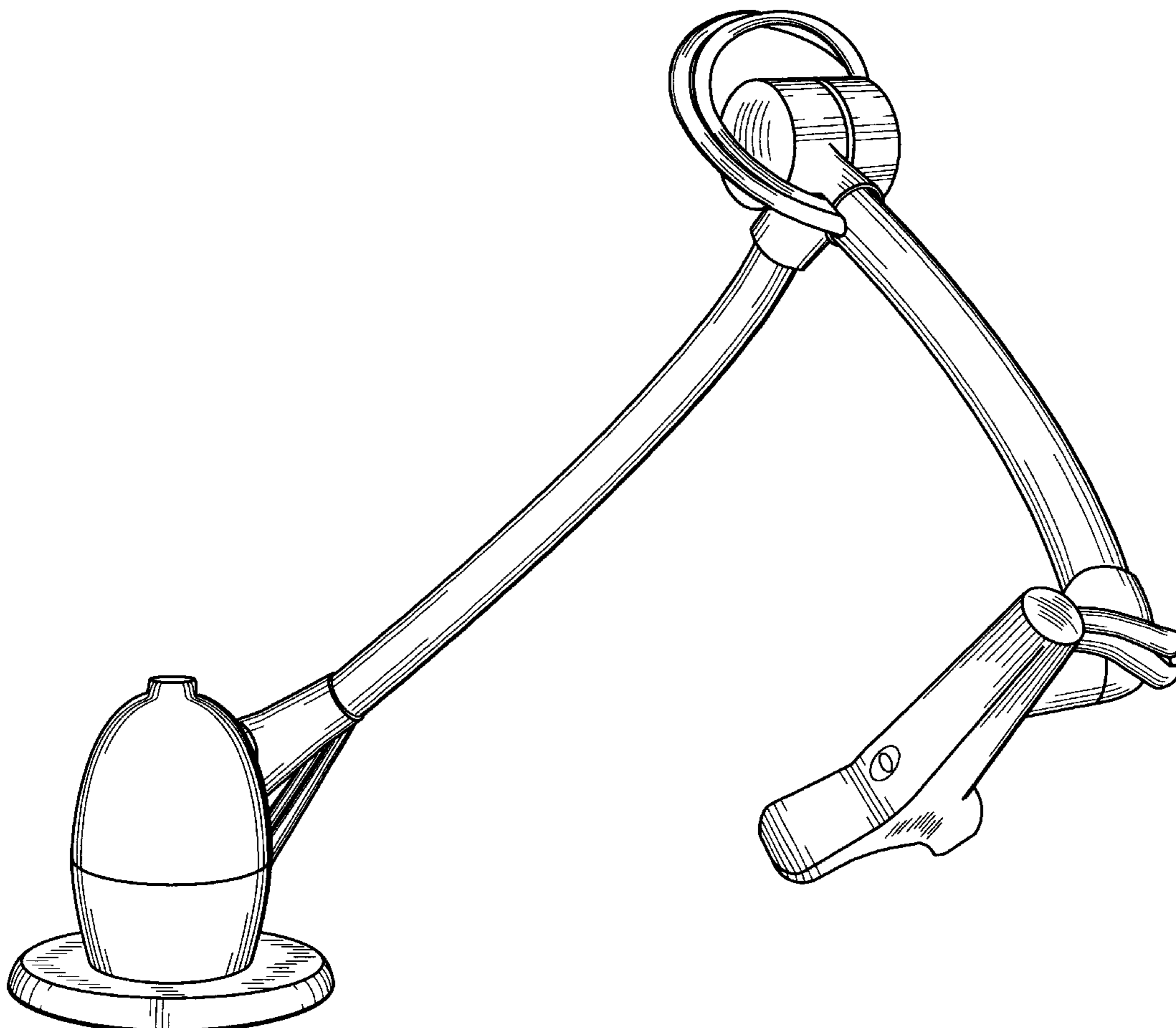

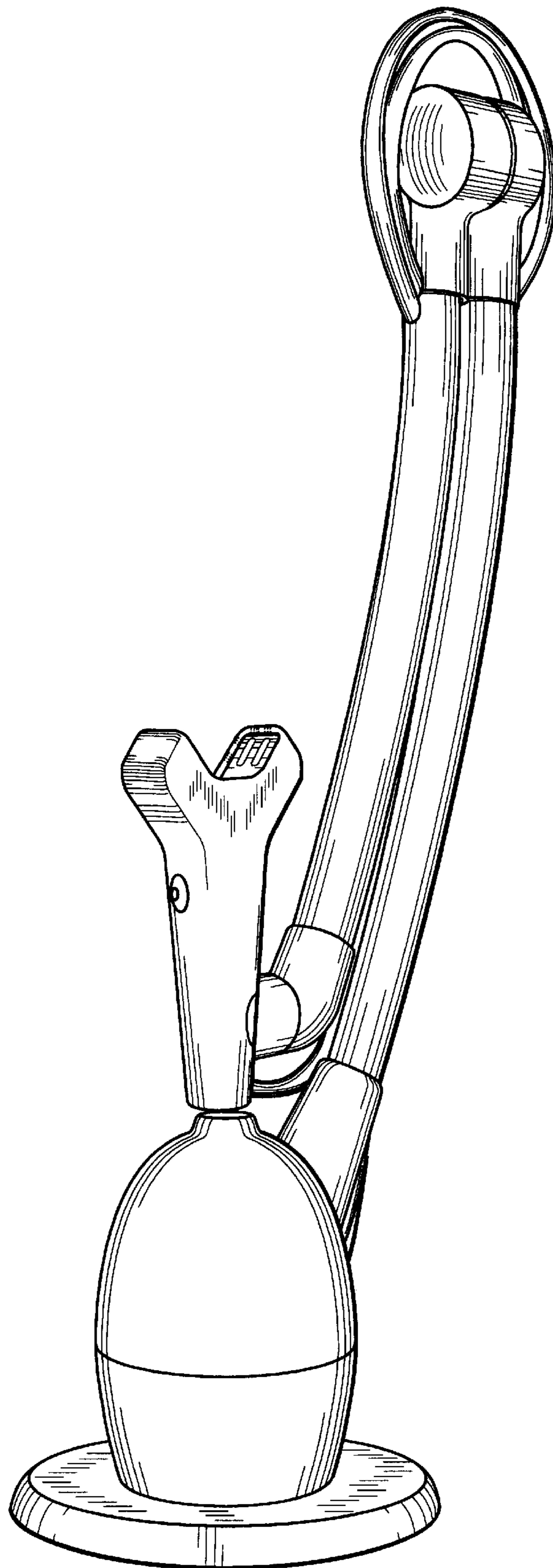

FIG. 1

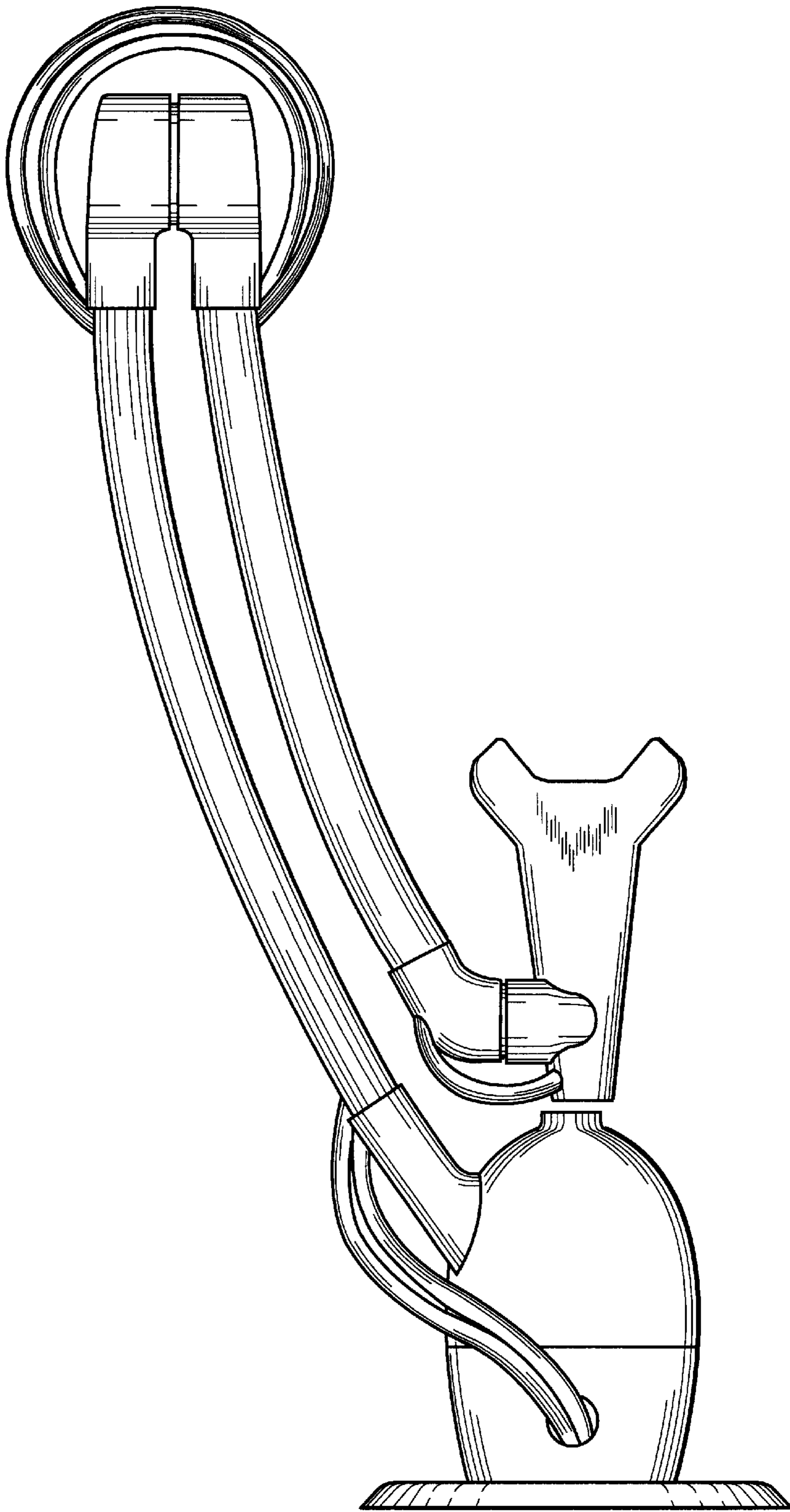

FIG. 2

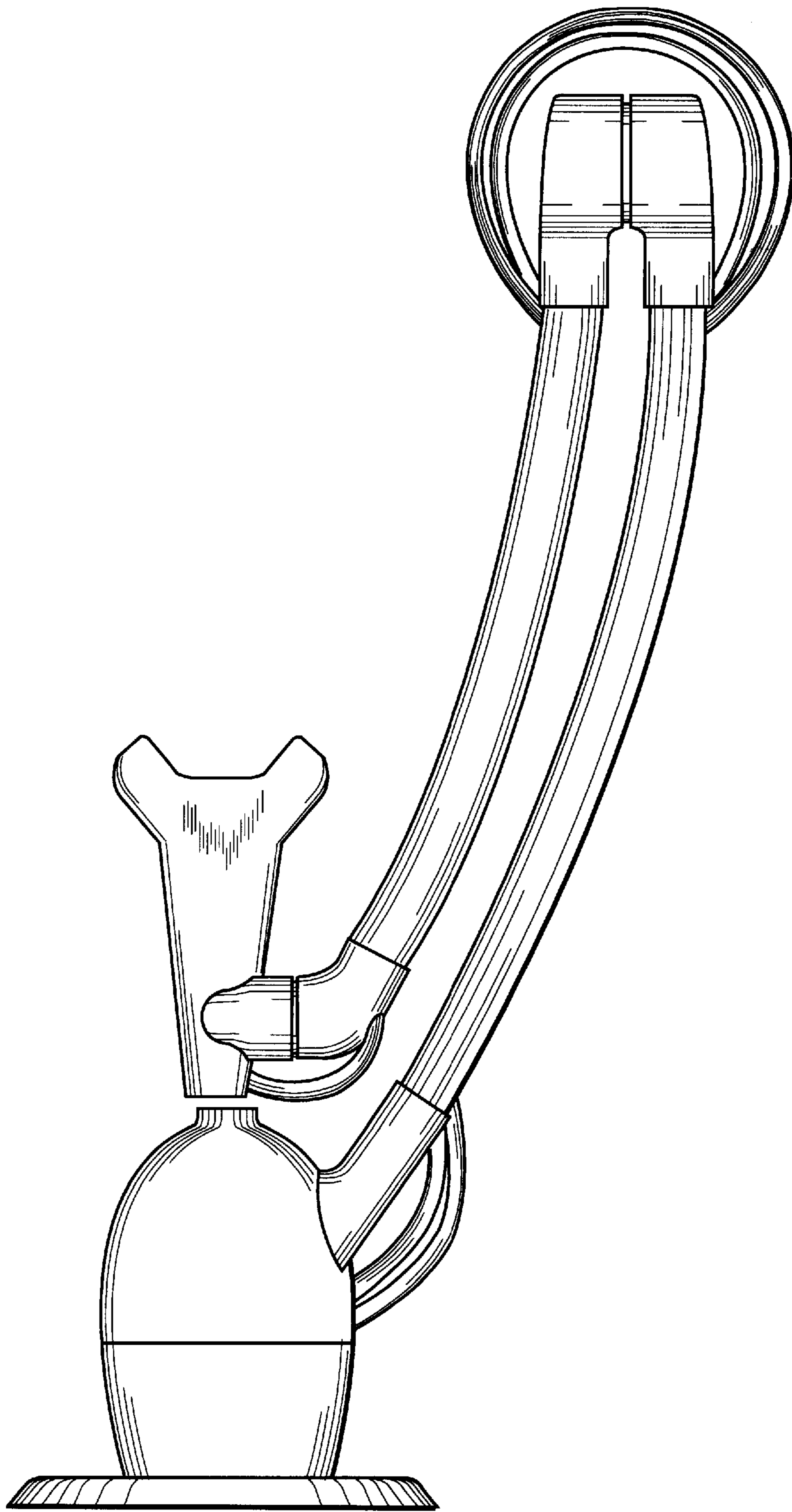

FIG. 3

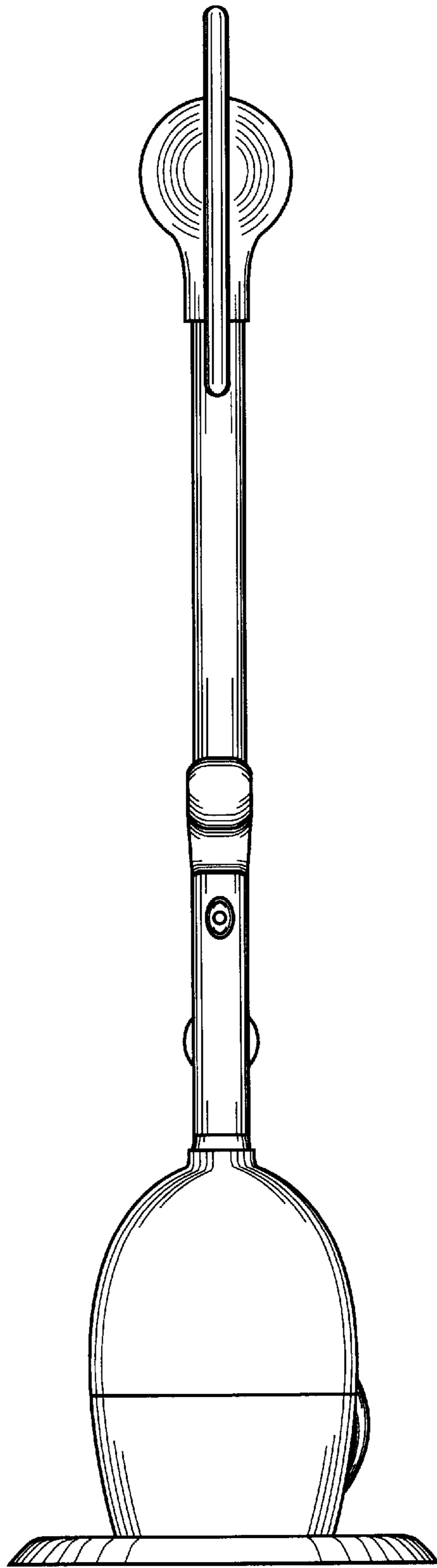

FIG. 4

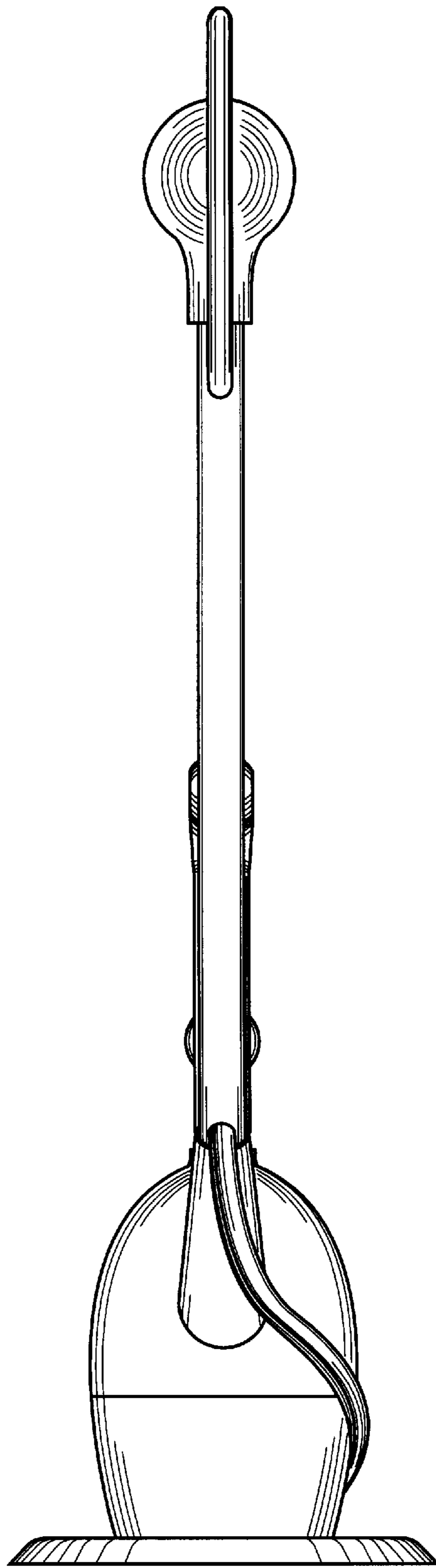

FIG. 5

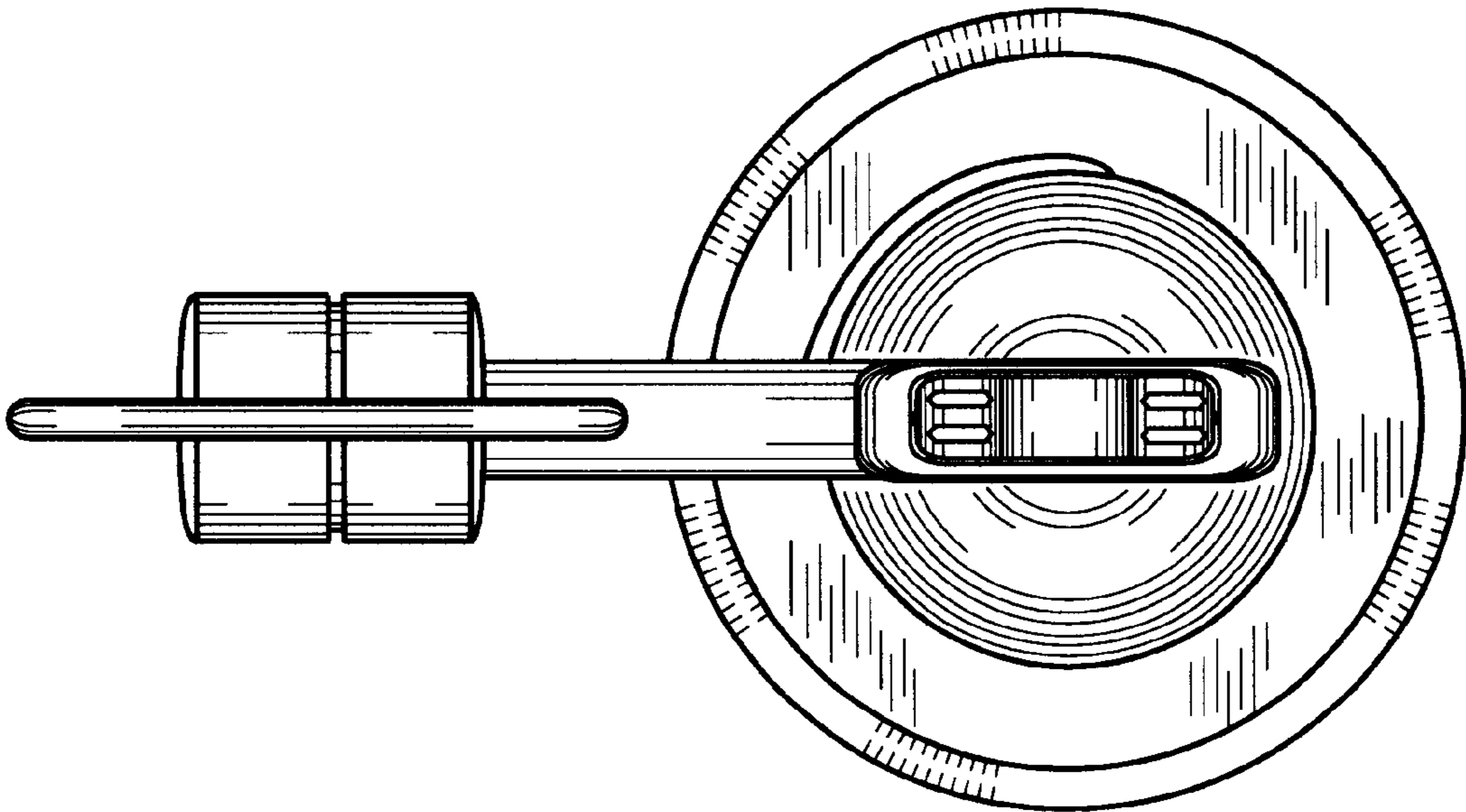

FIG. 6

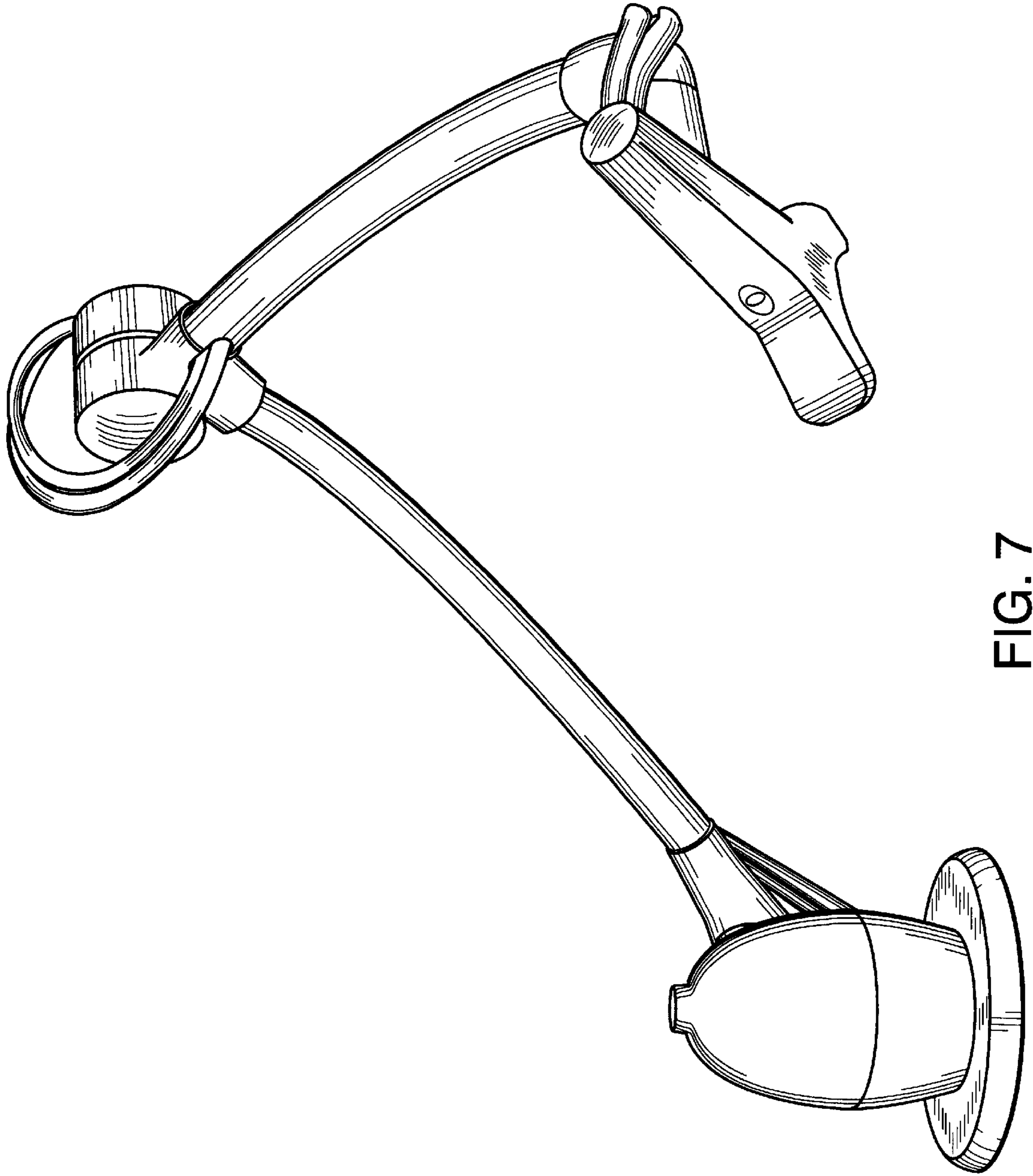

FIG. 7