



US00D438583S

(12) **United States Design Patent**
O'Doherty et al.

(10) **Patent No.:** **US D438,583 S**

(45) **Date of Patent:** **** Mar. 6, 2001**

(54) **GOLF CLUB HEAD**

(76) Inventors: **J. Bryan O'Doherty**, 270 SW. Birdshill Rd., Portland, OR (US) 97219; **Guy Mount, III**, 67367 Three Creeks Rd., Sisters, OR (US) 97759

(**) Term: **14 Years**

(21) Appl. No.: **29/122,611**

(22) Filed: **Apr. 28, 2000**

(51) **LOC (7) Cl.** **21-02**

(52) **U.S. Cl.** **D21/733**

(58) **Field of Search** D21/733, 752;
473/324, 327-331, 345, 346

(56) **References Cited**

U.S. PATENT DOCUMENTS

- D. 366,682 * 1/1996 Antonious D21/752
- D. 375,130 * 10/1996 Hlinka et al. D21/752
- 4,838,555 * 6/1989 Kobayashi 473/327

* cited by examiner

Primary Examiner—Mitchell Siegel

(74) *Attorney, Agent, or Firm*—Robert L. Harrington

(57) **CLAIM**

The ornamental design of a golf club head, as shown and described.

DESCRIPTION

FIG. 1 is a perspective view of a golf club head showing our new design;

FIG. 2 is a top view thereof;

FIG. 3 is a frontal view thereof;

FIG. 4 is a side view thereof;

FIG. 5 is a rear view thereof;

FIG. 6 is a side view thereof opposite that of FIG. 4; and,

FIG. 7 is a bottom view thereof.

The broken line showing of the fragmented shaft is for illustrative purposes only and forms no part of the claimed design.

1 Claim, 1 Drawing Sheet

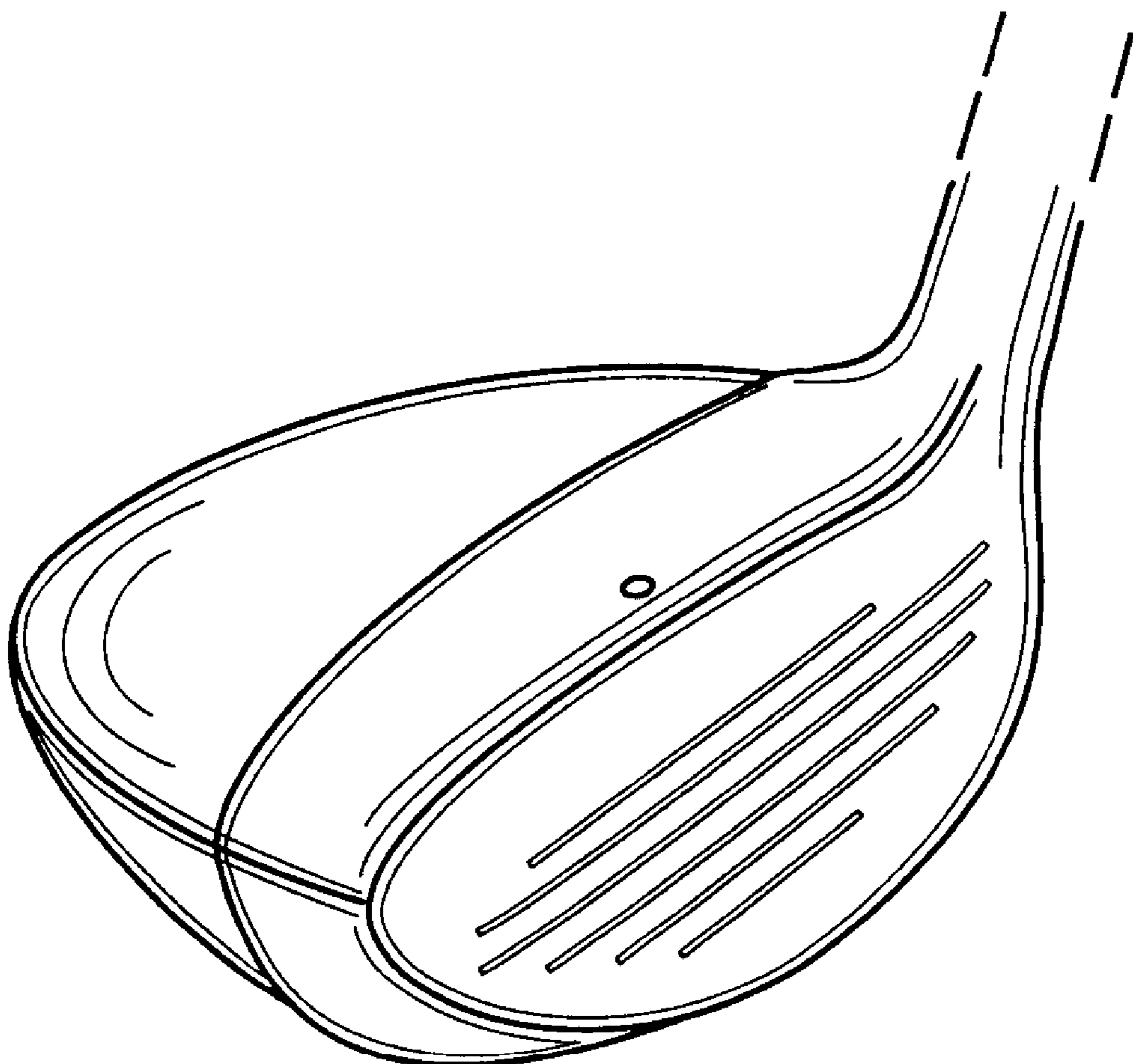

FIG. 1

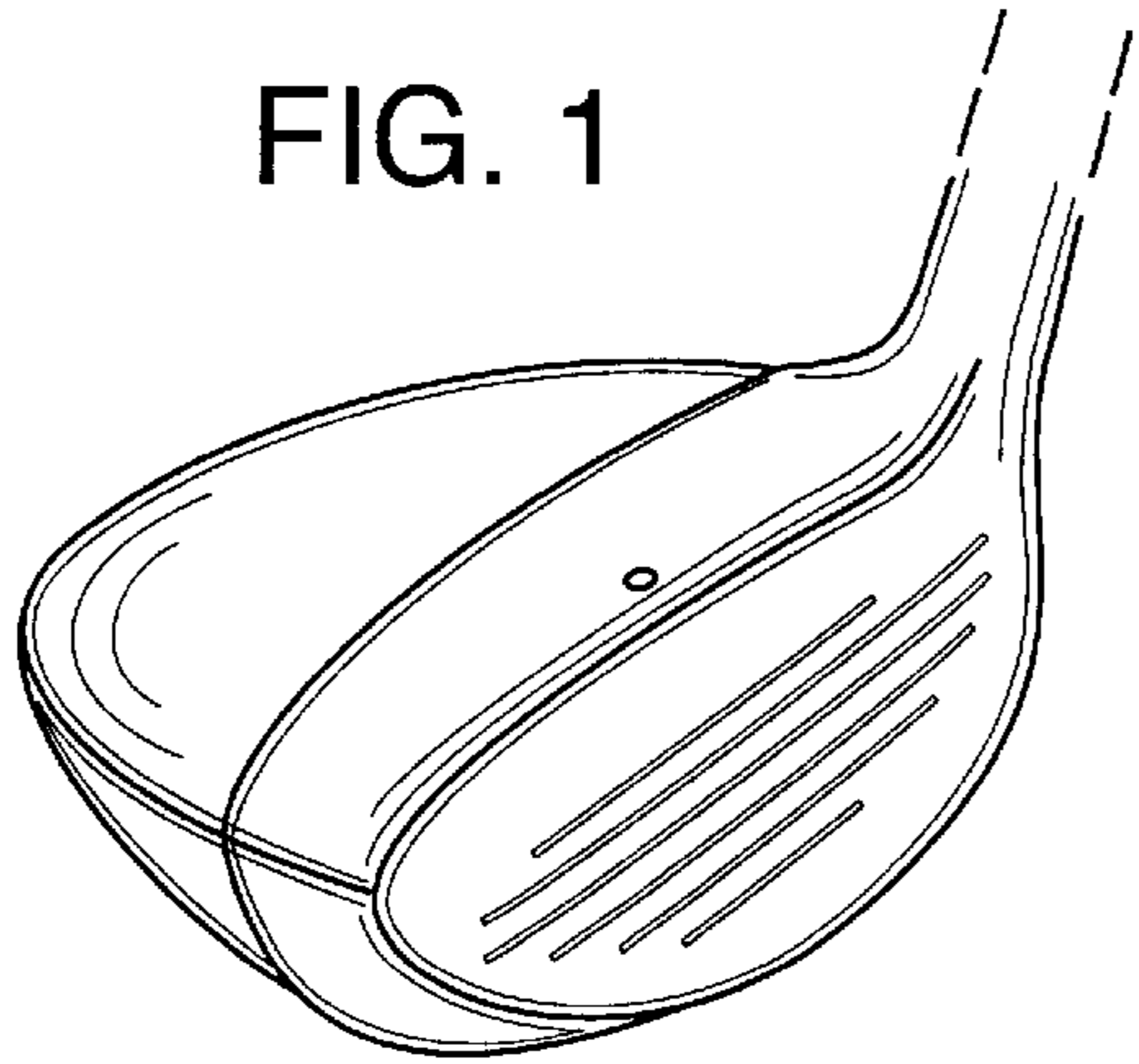

FIG. 2

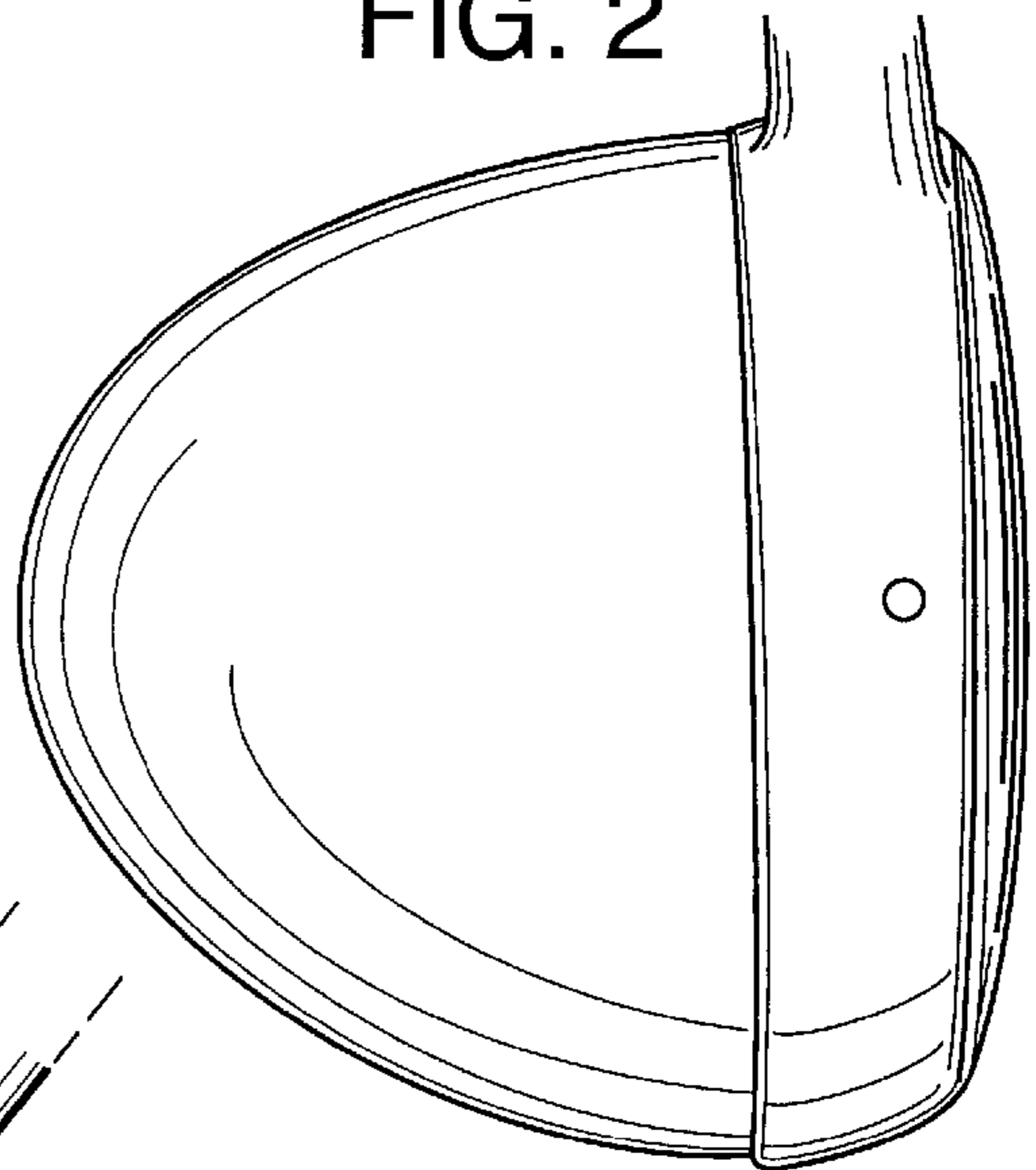

FIG. 3

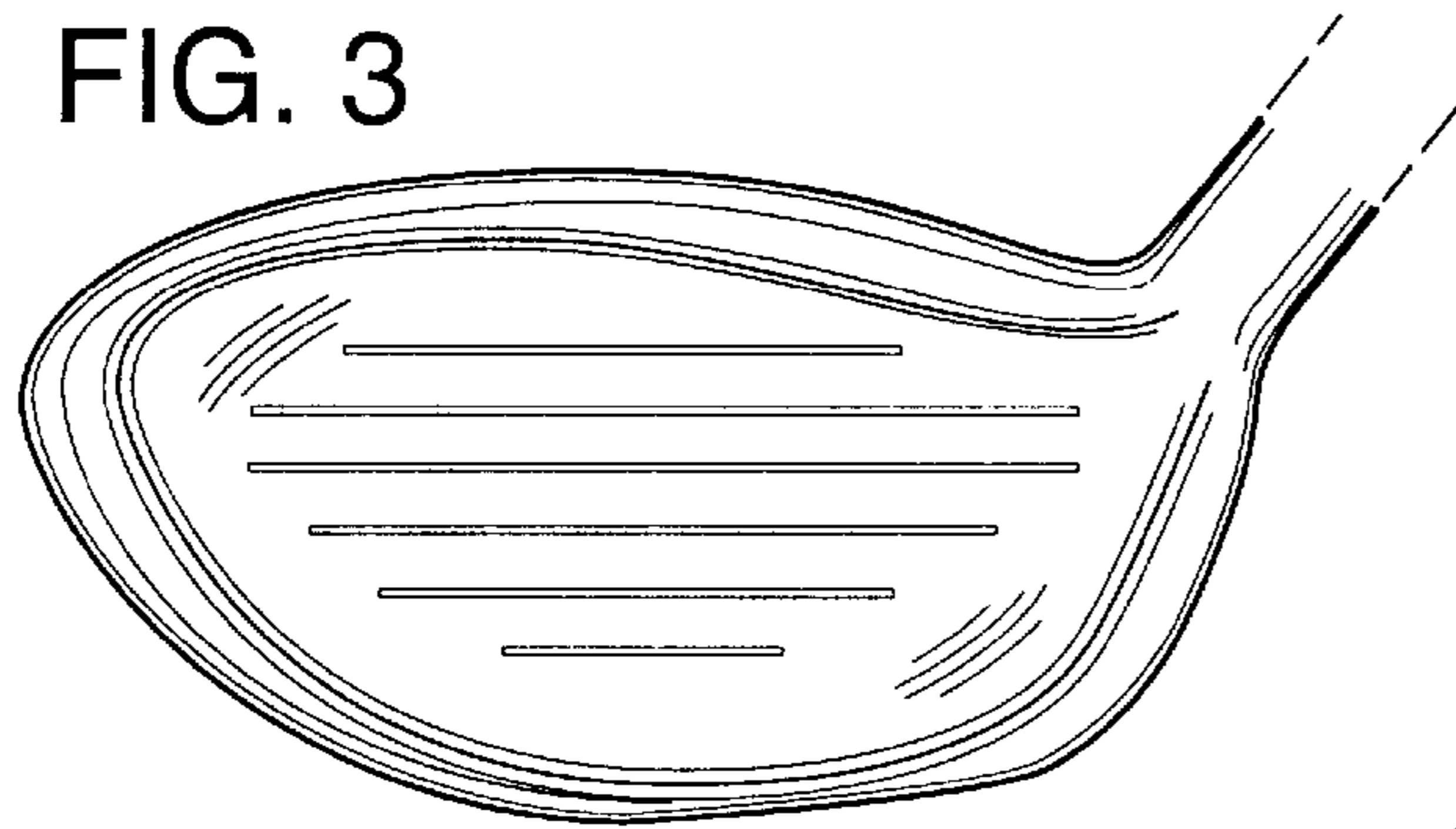

FIG. 4

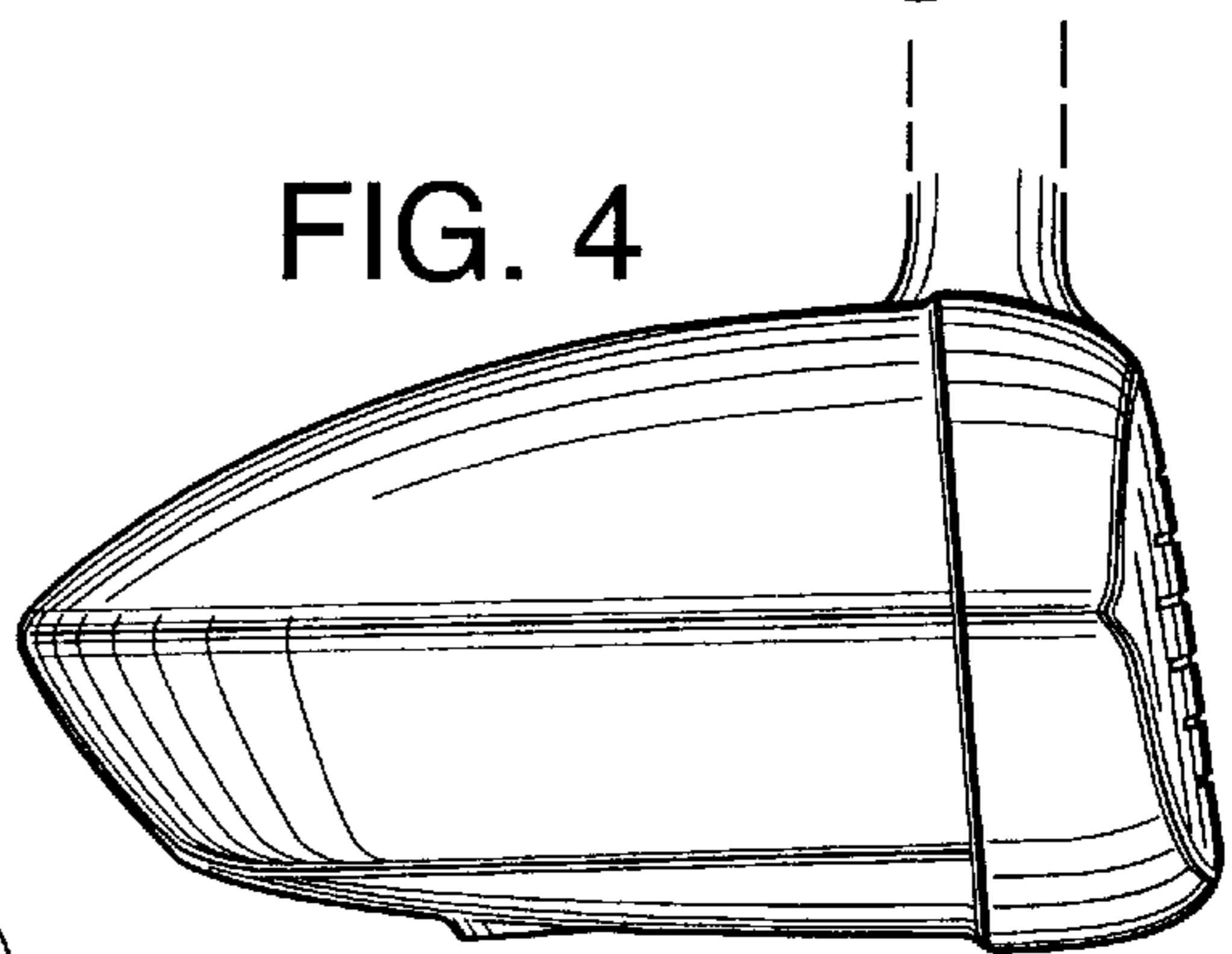

FIG. 5

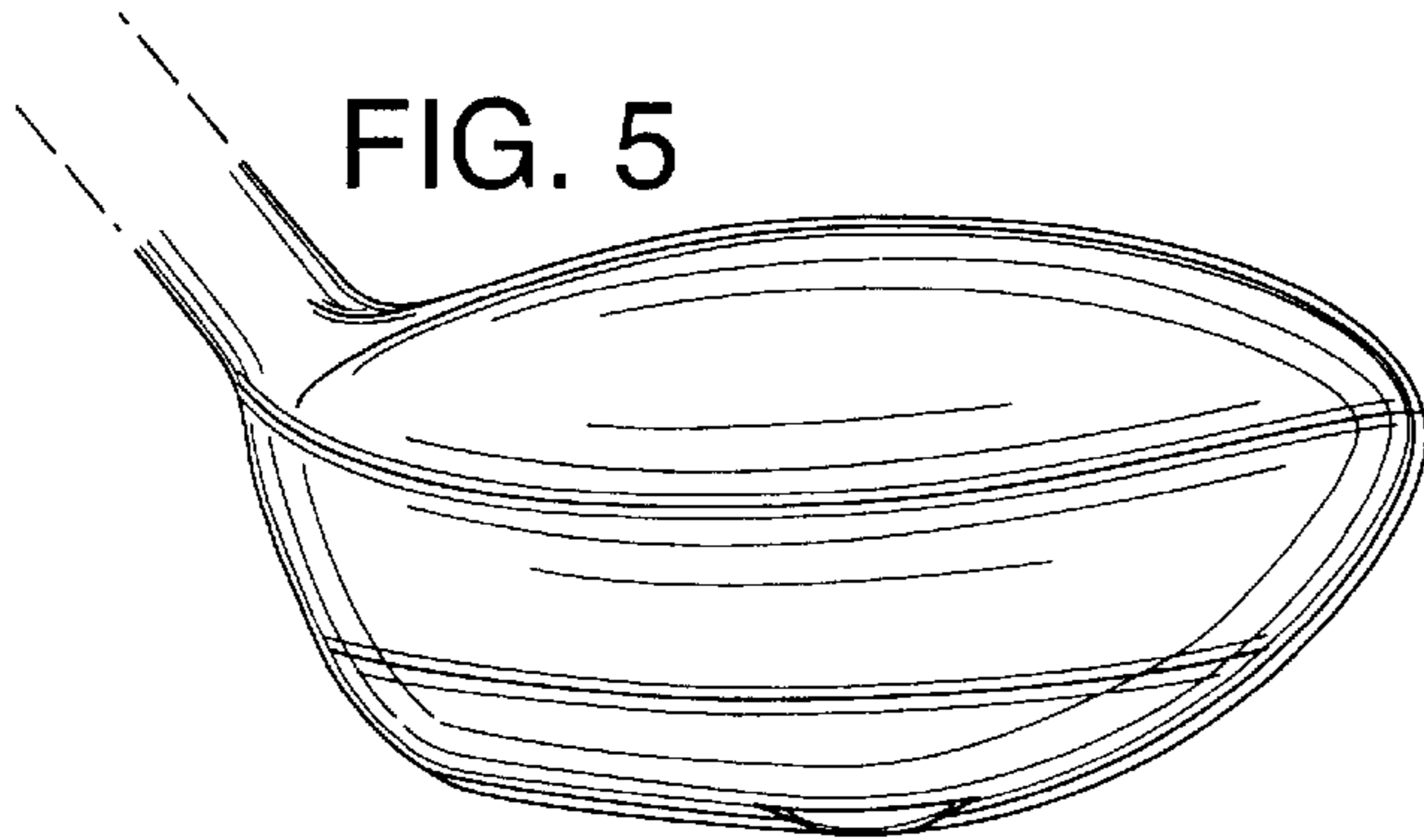

FIG. 7

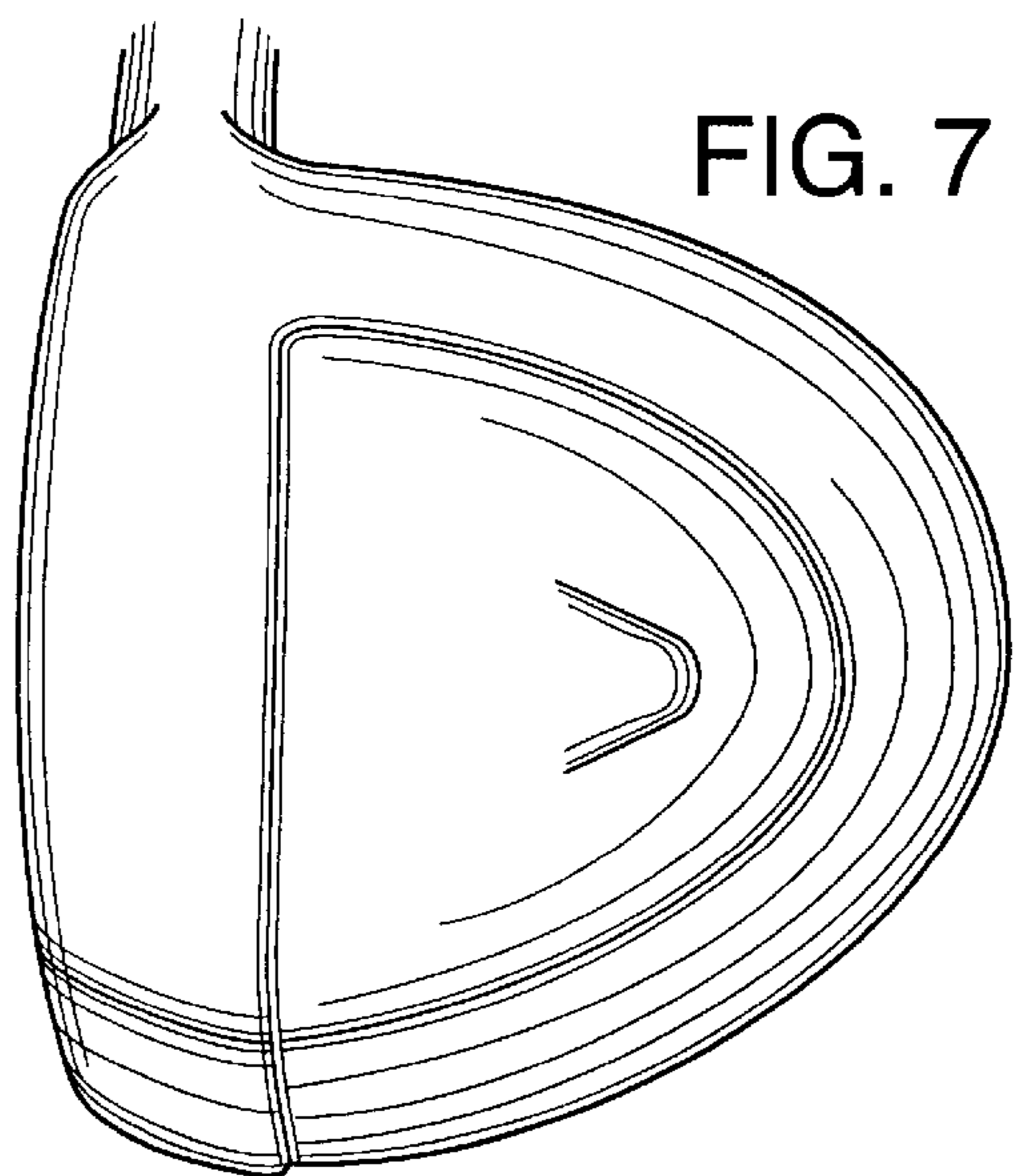

FIG. 6

