



US00D438580S

(12) **United States Design Patent**  
**Shaw**

(10) **Patent No.:** **US D438,580 S**

(45) **Date of Patent:** **\*\* Mar. 6, 2001**

(54) **HOUSING FOR AN EXERCISE MACHINE**

(76) **Inventor:** **Ching-Song Shaw**, 21F-3, No. 218,  
Feng Chia Road, Taichung (TW)

(\*\*) **Term:** **14 Years**

(21) **Appl. No.:** **29/117,493**

(22) **Filed:** **Jan. 28, 2000**

(51) **LOC (7) Cl.** ..... **21-02**

(52) **U.S. Cl.** ..... **D21/697; D21/663**

(58) **Field of Search** ..... D21/662, 663,  
D21/665, 667, 668, 670, 694, 697; 482/51,  
52, 57, 70, 71

(56) **References Cited**

**U.S. PATENT DOCUMENTS**

D. 343,659	*	1/1994	Kiishi	.....	D21/667
D. 344,313	*	2/1994	Wu	.....	D21/663
D. 353,690	*	12/1994	Tsushi et al.	.....	D21/663
D. 360,002	*	7/1995	Wu	.....	D21/667
D. 366,298	*	1/1996	Wu	.....	D21/663
D. 372,061	*	7/1996	Chen	.....	D21/667
D. 397,383	*	8/1998	Sands et al.	.....	D21/663

D. 401,644	*	11/1998	Chen	.....	D21/663
D. 406,288	*	3/1999	Chen	.....	D21/663
5,902,215	*	5/1999	Kuo	.....	482/57
6,007,462	*	12/1999	Chen	.....	482/57

\* cited by examiner

*Primary Examiner*—Philip S. Hyder

(74) *Attorney, Agent, or Firm*—Browdy and Neimark

(57) **CLAIM**

The ornamental design for a housing for an exercise machine, as shown and described.

**DESCRIPTION**

FIG. 1 shows a perspective view of the present design.  
 FIG. 2 shows a right side elevational view of the present design.  
 FIG. 3 shows a top plan view of the present design.  
 FIG. 4 shows a front elevational view of the present design.  
 FIG. 5 shows a bottom plan view of the present design.  
 FIG. 6 shows a left side elevational view of the present design; and,  
 FIG. 7 shows a rear elevational view of the present design.

**1 Claim, 3 Drawing Sheets**

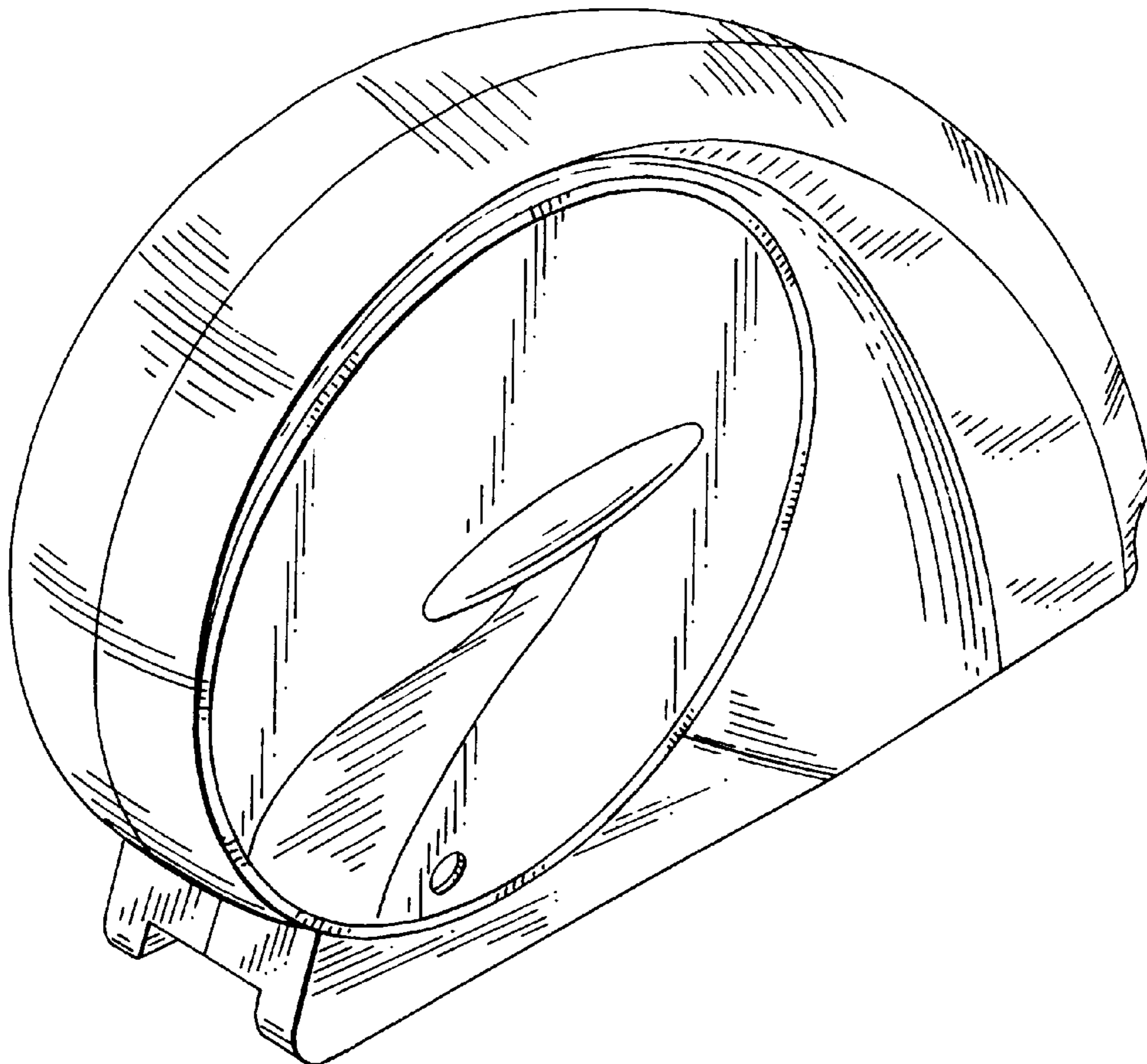

FIG. 1

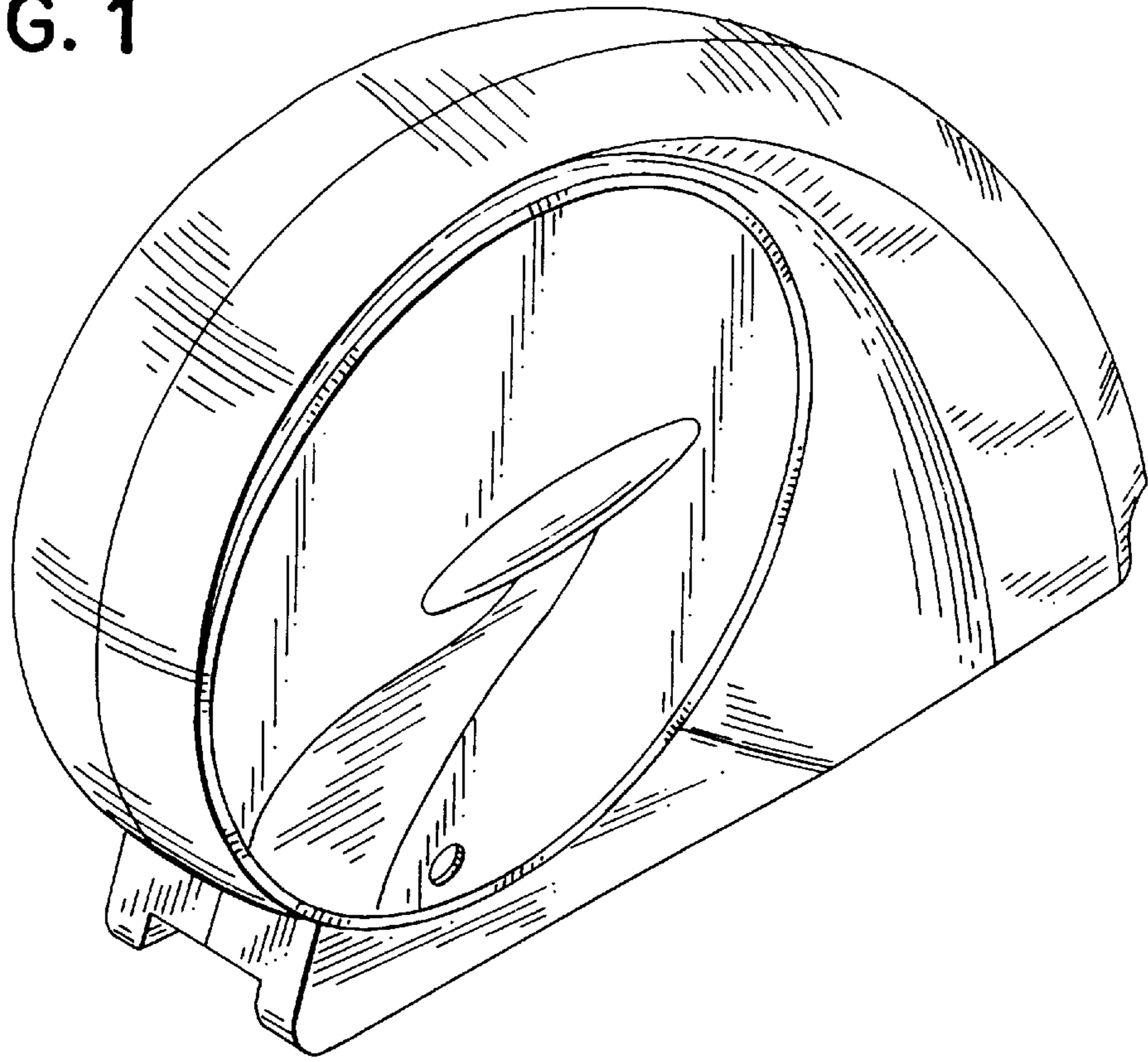

FIG. 2

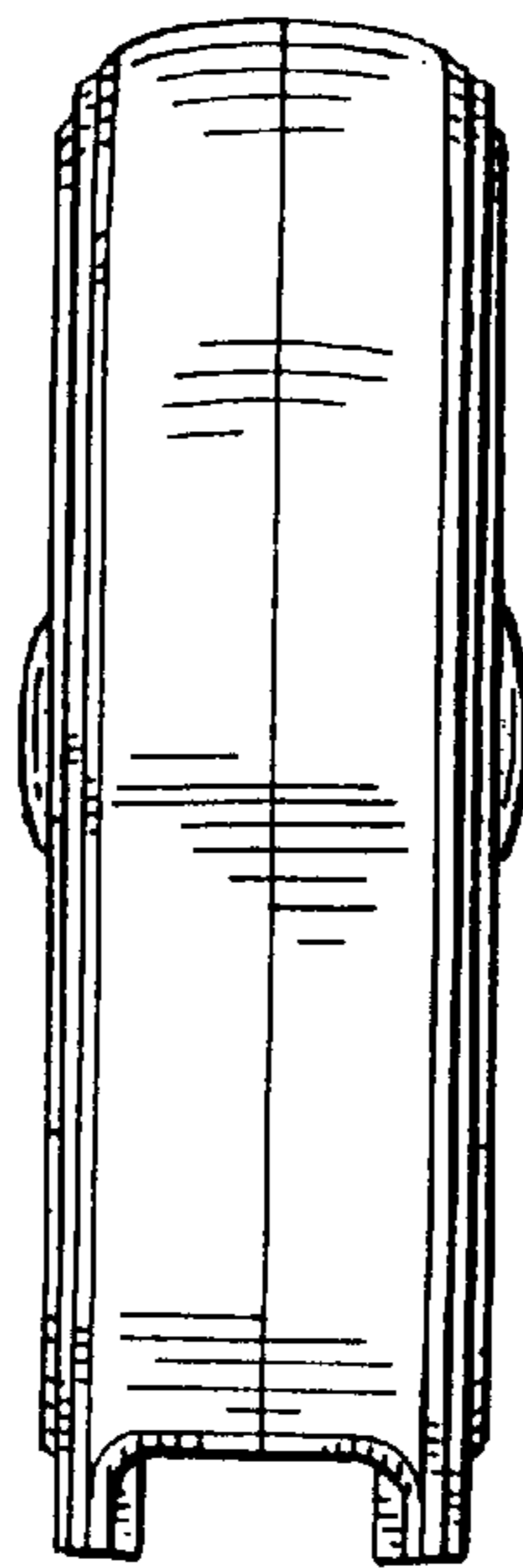

FIG. 3

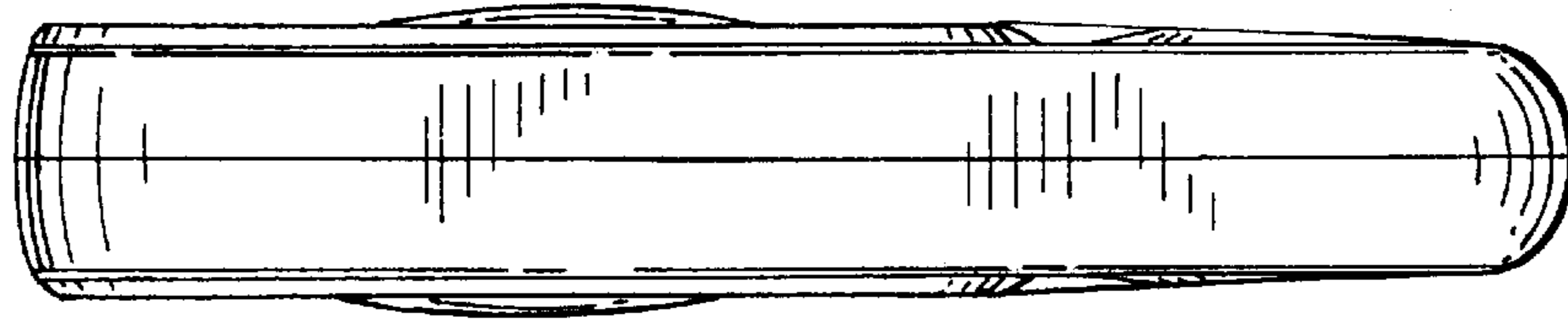

FIG. 4

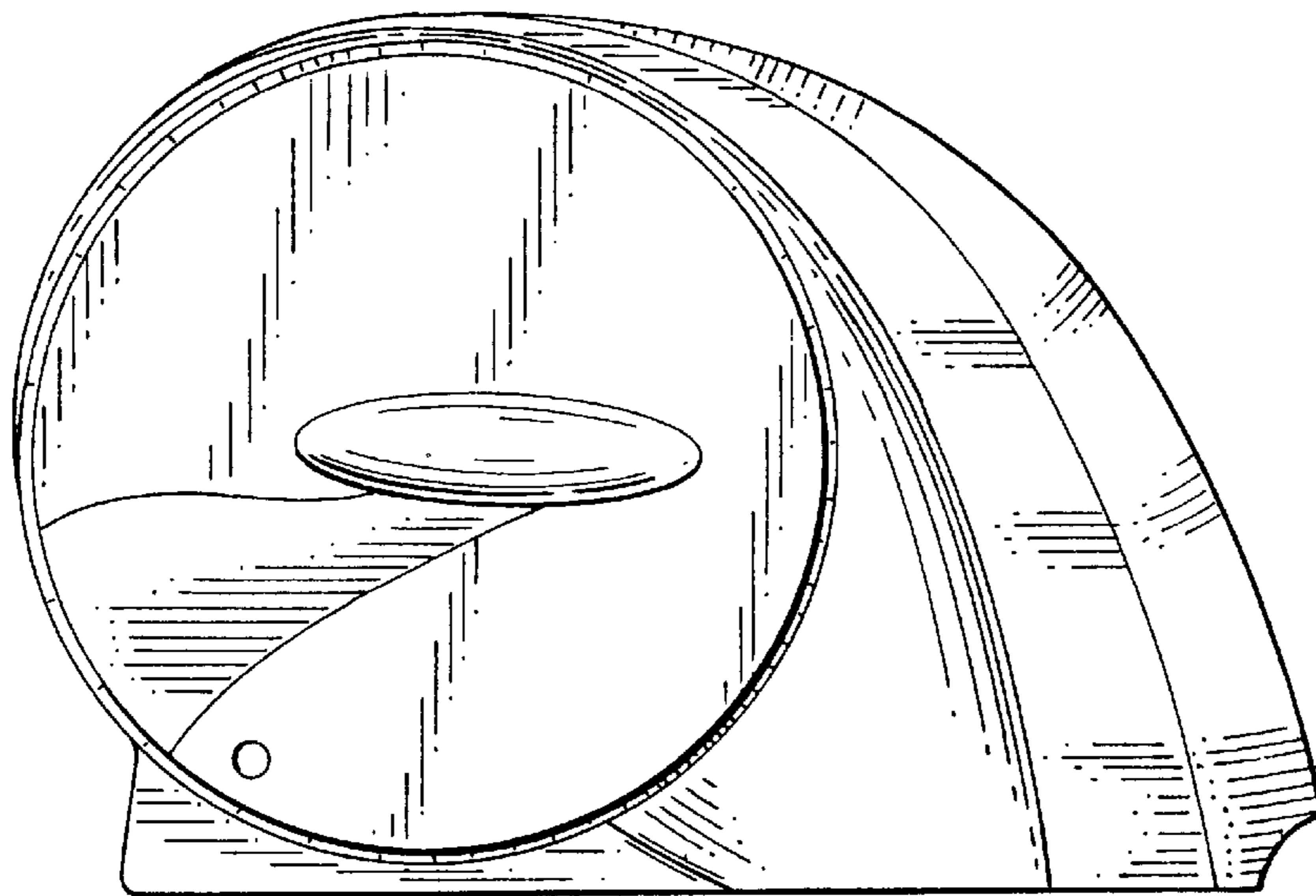

FIG. 5

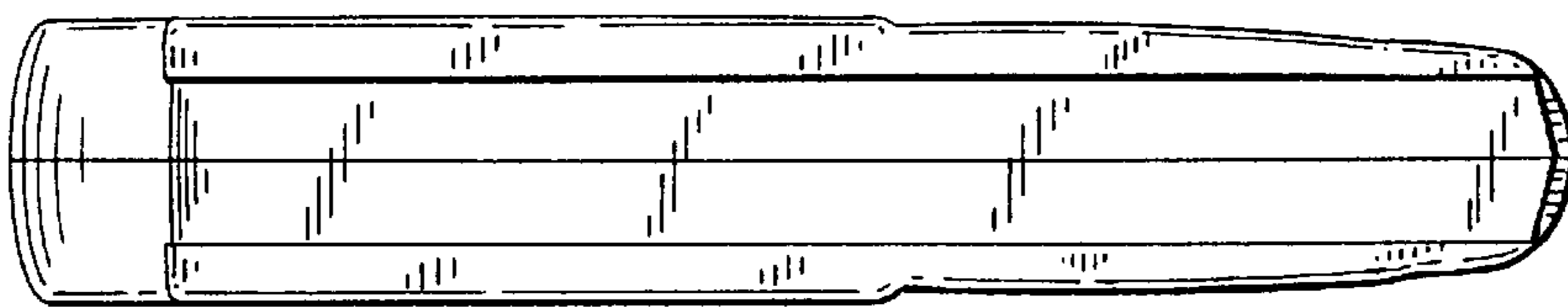

FIG. 6

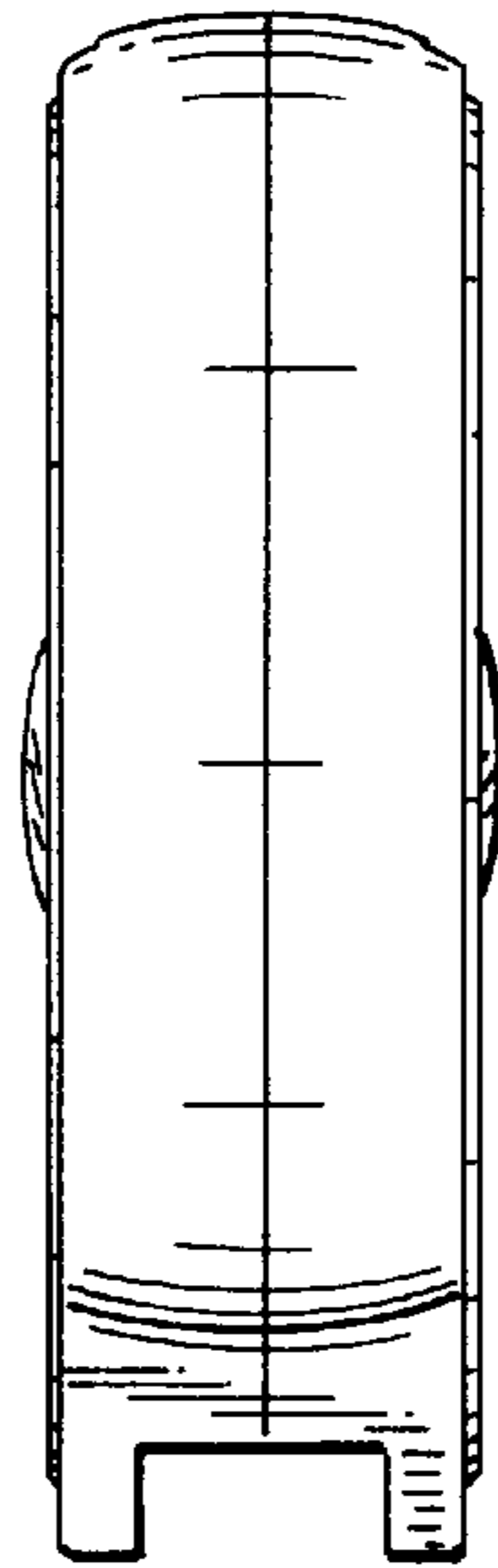

FIG. 7

