



US00D438559S

(12) **United States Design Patent**
Matsumoto et al.

(10) **Patent No.:** **US D438,559 S**

(45) **Date of Patent:** **** Mar. 6, 2001**

(54) **ELECTRONIC COPIER**

(75) Inventors: **Kenji Matsumoto**, Tokyo; **Atsushi Ogane**, Hachioji; **Naoki Otomo**, Hachioji; **Shun Kawata**, Hachioji, all of (JP)

(73) Assignee: **Konica Corporation**, Tokyo (JP)

(**) Term: **14 Years**

(21) Appl. No.: **29/122,811**

(22) Filed: **May 4, 2000**

(30) **Foreign Application Priority Data**

Nov. 25, 1999 (JP) 11-32441

(51) **LOC (7) Cl.** **16-03**

(52) **U.S. Cl.** **D18/39**

(58) **Field of Search** D18/36-39; 399/1-7, 399/130, 151, 411

(56) **References Cited**

U.S. PATENT DOCUMENTS

- D. 320,808 * 10/1991 Ishida D18/37
- D. 328,609 * 8/1992 Isida D18/36
- D. 331,595 * 12/1992 Ishida D18/38

- D. 374,454 * 10/1996 Naruki et al. D18/36
- D. 404,419 * 1/1999 Kusanagi D18/39
- D. 408,443 * 4/1999 Sasaki D18/36
- D. 410,675 * 6/1999 Ohashi D18/36
- D. 415,787 * 10/1999 Clark, III et al. D18/36
- D. 423,040 * 4/2000 Ohta et al. D18/36
- D. 425,929 * 5/2000 Imai D18/36

* cited by examiner

Primary Examiner—Caron D. Veynar

(74) *Attorney, Agent, or Firm*—Frishauf, Holtz, Goodman, Langer & Chick, P.C.

(57) **CLAIM**

The ornamental design for an electronic copier, as shown and described.

DESCRIPTION

FIG. 1 is a front elevational view of an electronic photocopier showing our new design;
 FIG. 2 is a left side-elevational view thereof;
 FIG. 3 is a right-side elevational view thereof;
 FIG. 4 is a rear elevational view thereof;
 FIG. 5 is a top plan view thereof;
 FIG. 6 is a bottom plan view thereof; and,
 FIG. 7 is a front, left side and top perspective view thereof.

1 Claim, 6 Drawing Sheets

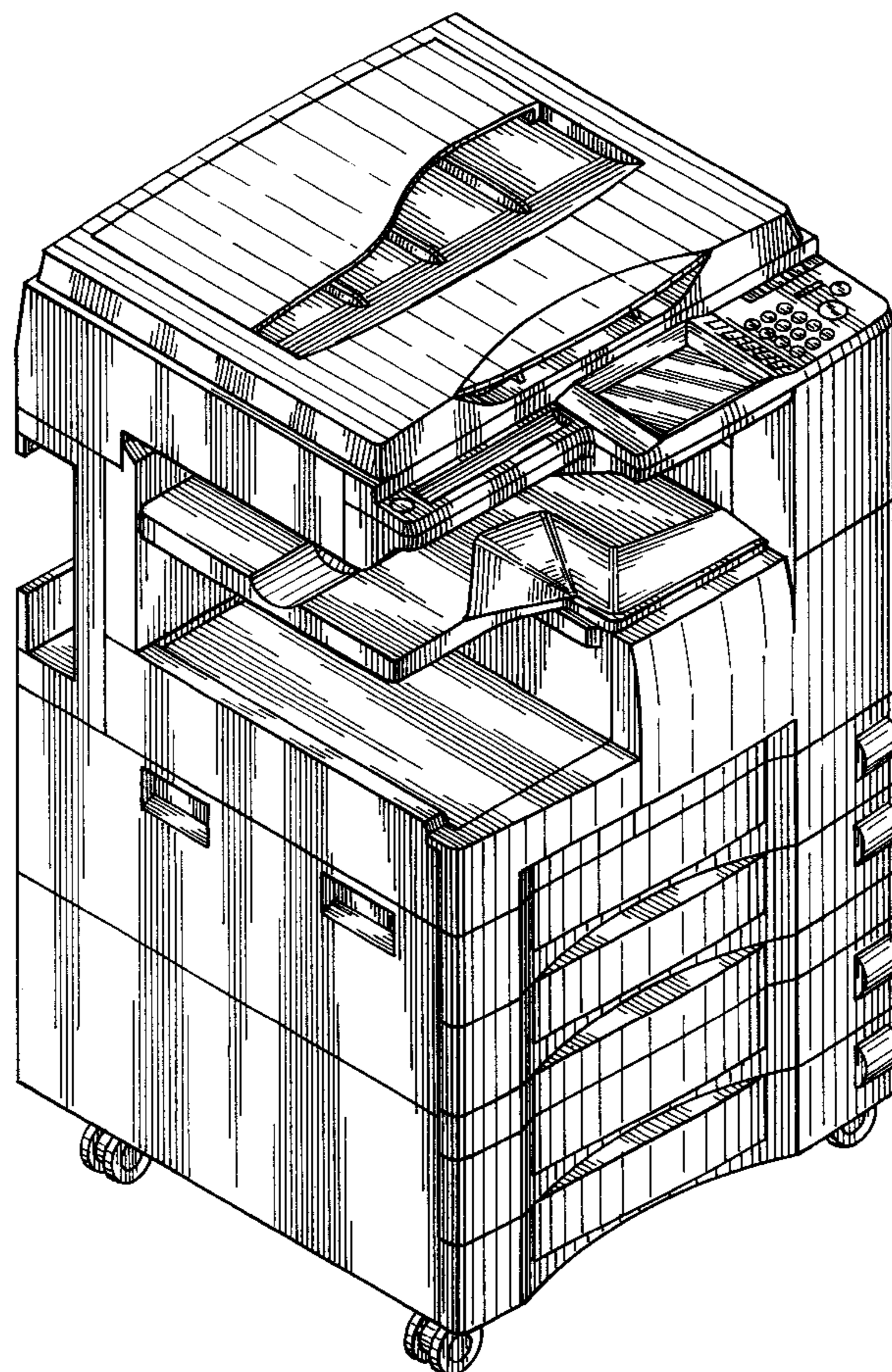

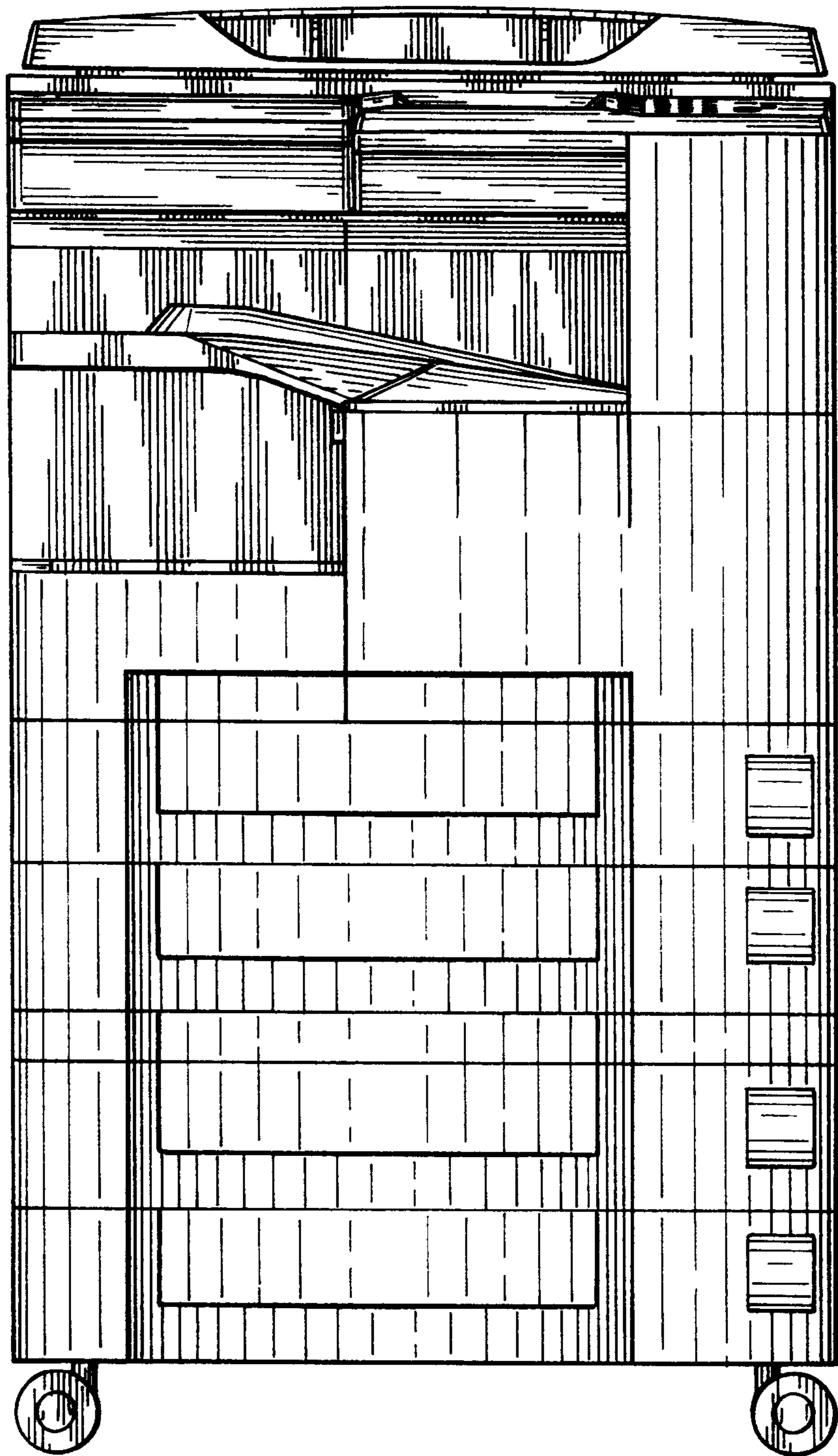

Fig. 1

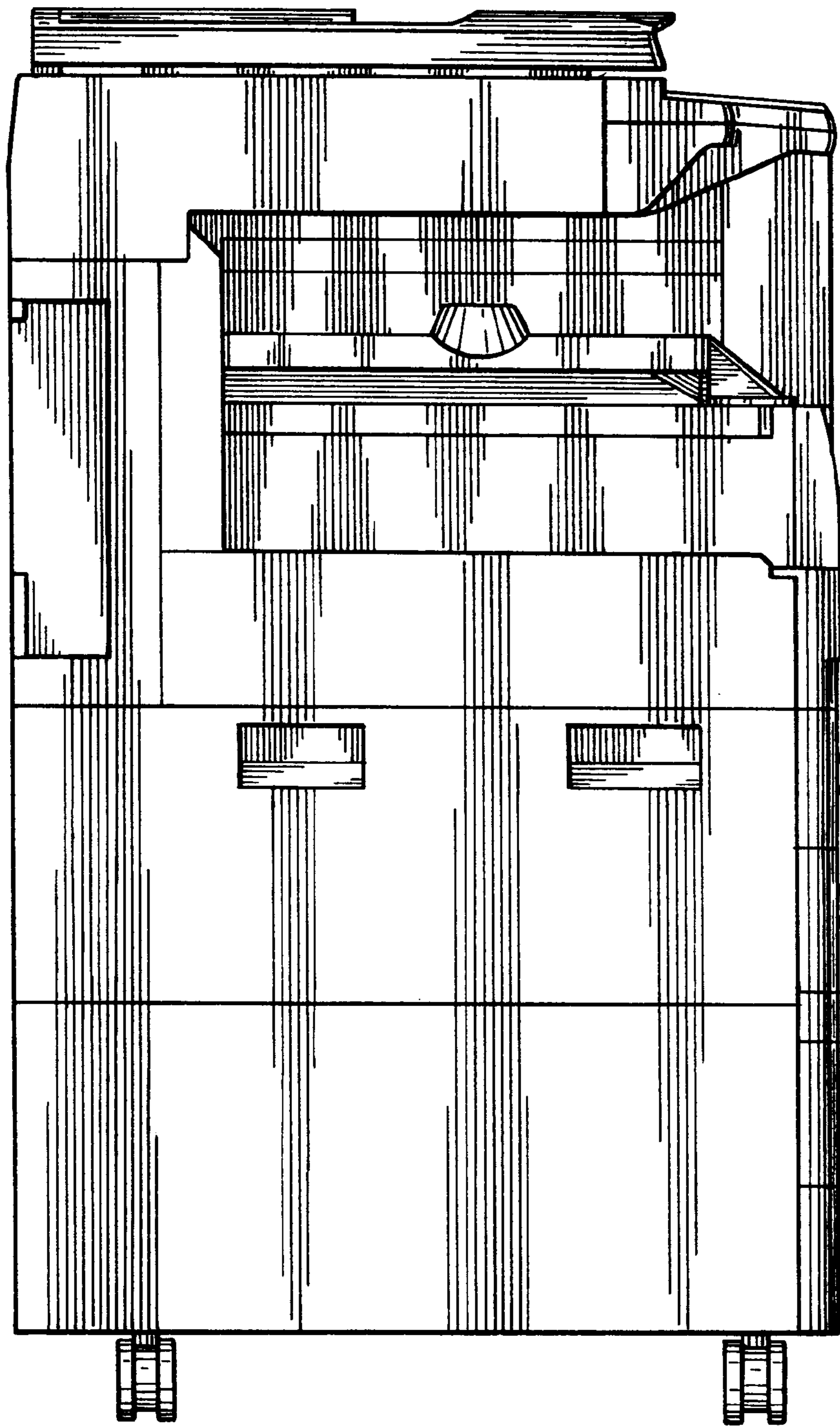

Fig. 2

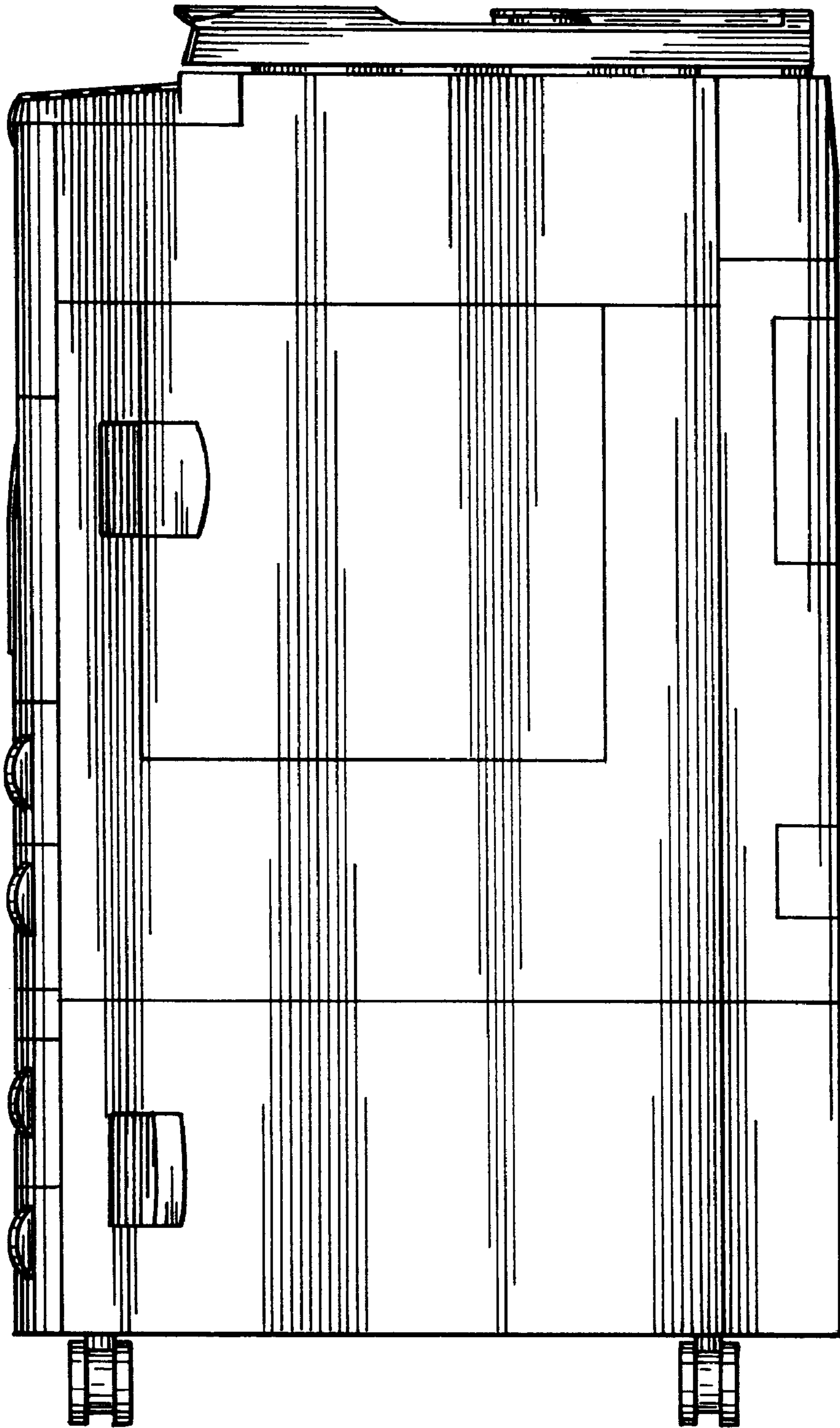

Fig. 3

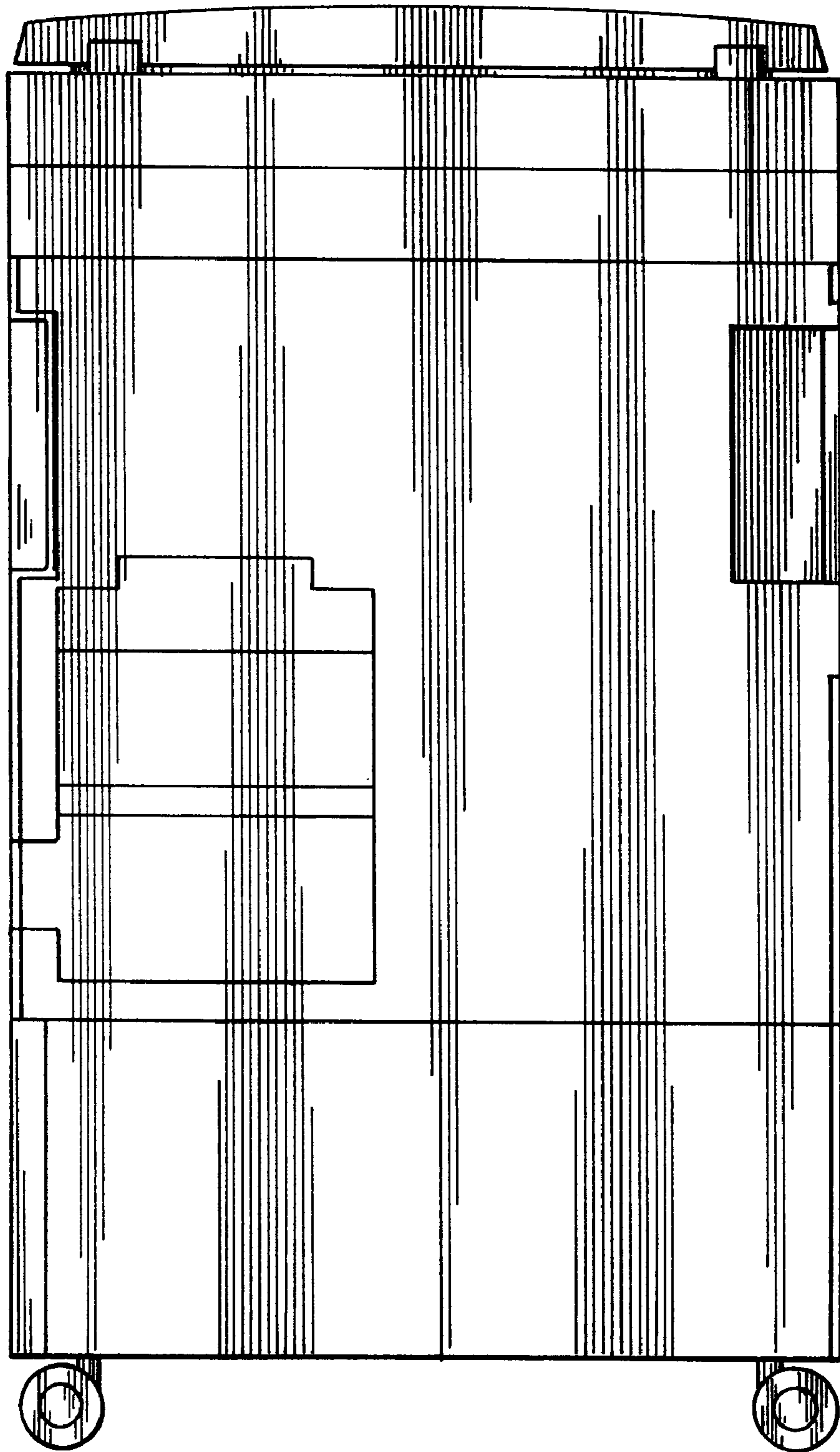

Fig. 4

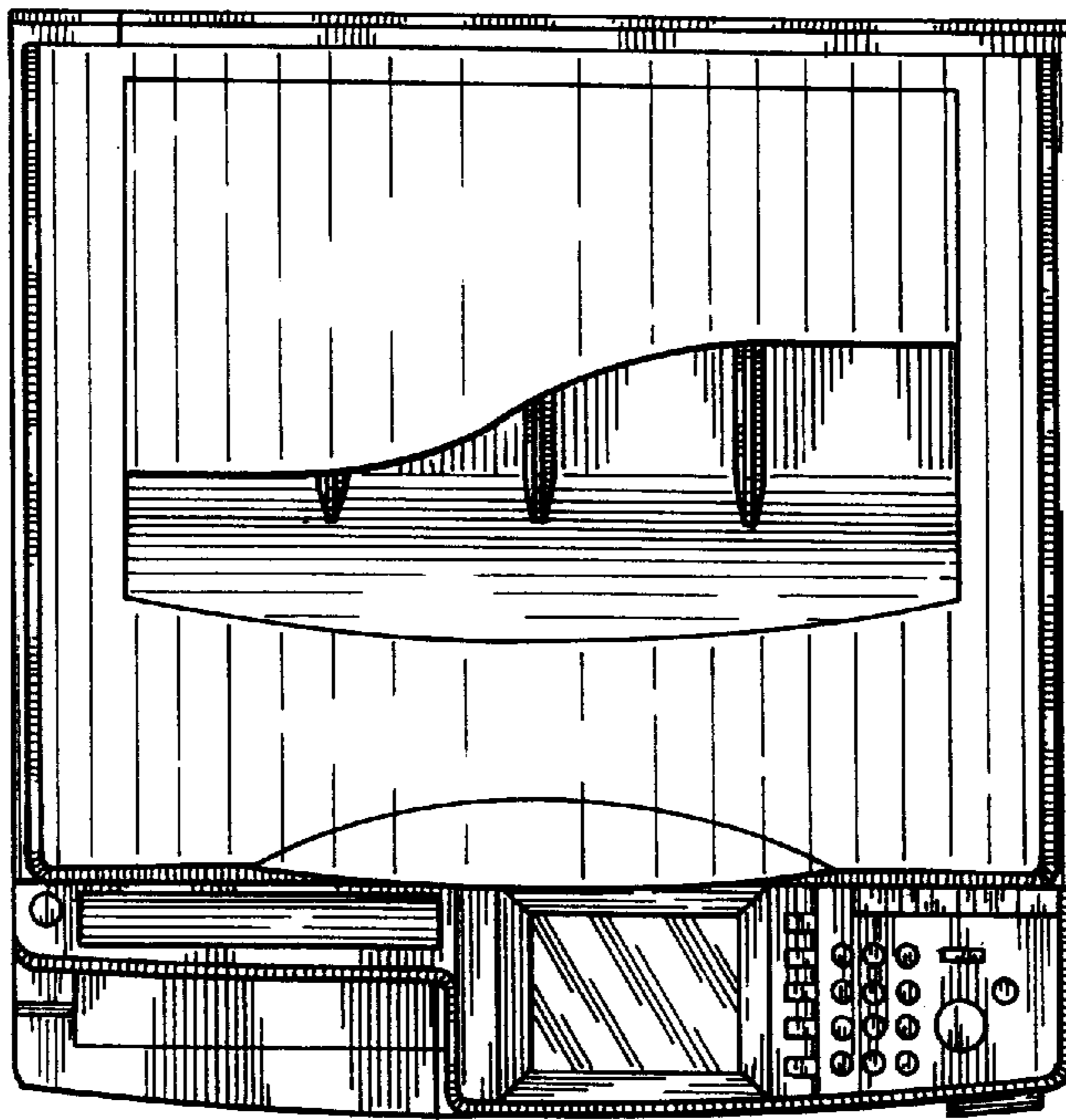

Fig. 5

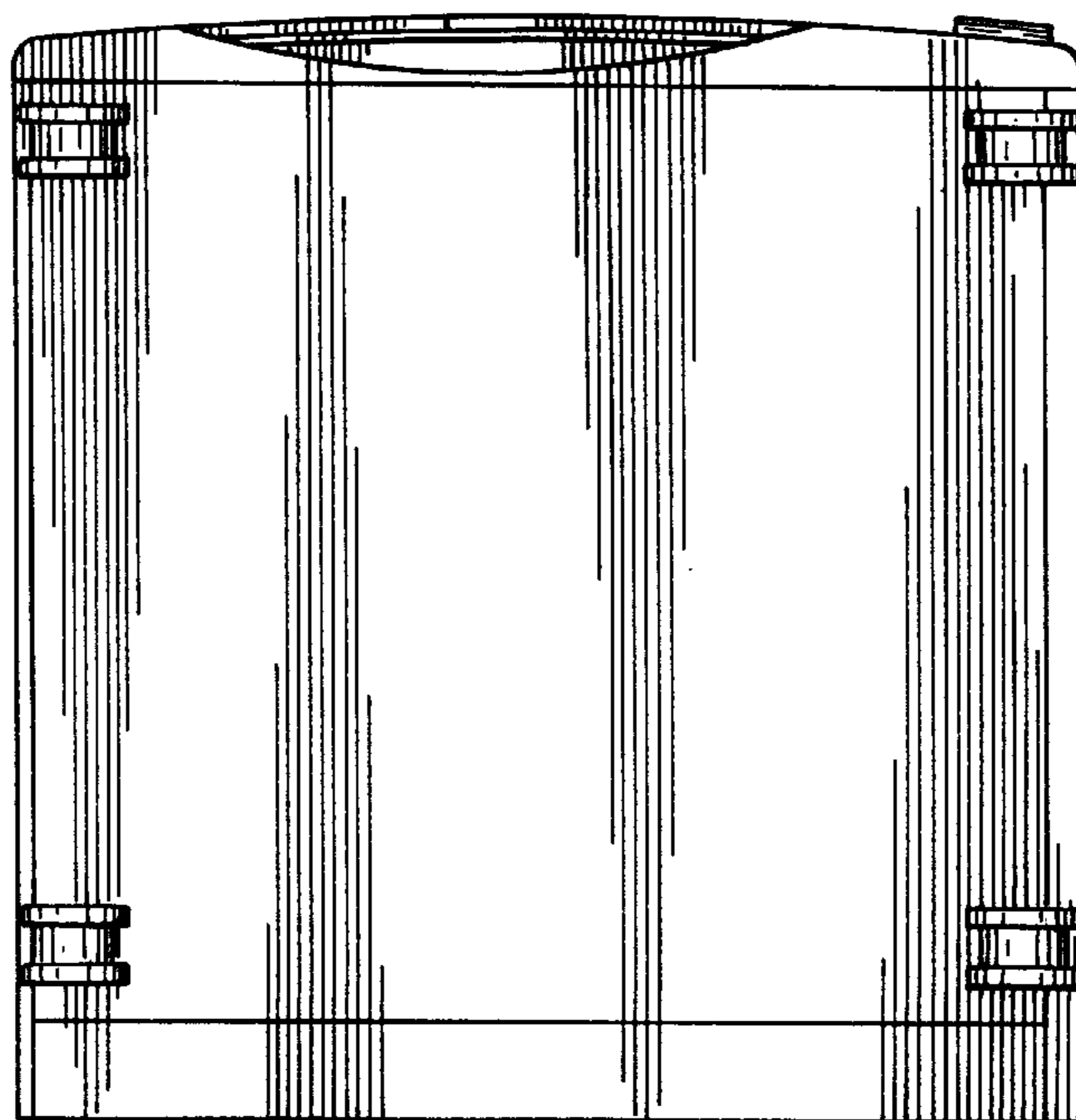

Fig. 6

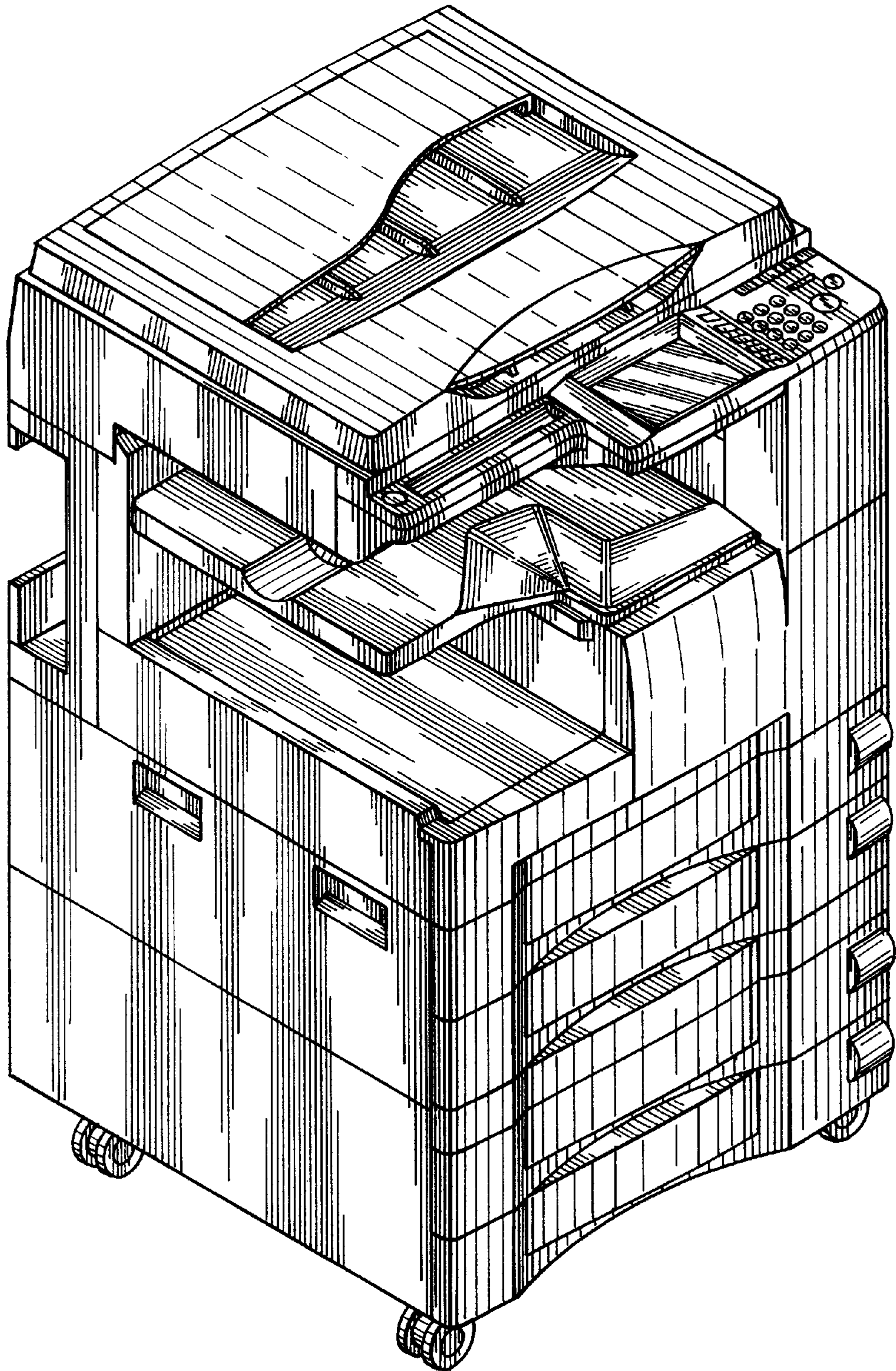

Fig. 7