



US00D438553S

(12) **United States Design Patent**  
**Sekine et al.**

(10) **Patent No.:** **US D438,553 S**  
(45) **Date of Patent:** **\*\* Mar. 6, 2001**

(54) **VIDEO CAMERA WITH VIDEO TAPE RECORDER**

(75) Inventors: **Tetsuya Sekine; Masahito Owada,**  
both of Yokohama (JP)

(73) Assignee: **Canon Kabushiki Kaisha, Tokyo (JP)**

(\*\*) Term: **14 Years**

(21) Appl. No.: **29/125,179**

(22) Filed: **Jun. 20, 2000**

(30) **Foreign Application Priority Data**

Dec. 27, 1999 (JP) ..... 11-036154

(51) **LOC (7) Cl.** ..... **16-01**

(52) **U.S. Cl.** ..... **D16/202**

(58) **Field of Search** ..... D16/200-206,  
D16/208; 348/373-376; 352/242, 243; 358/906;  
396/535-541

(56) **References Cited**

**U.S. PATENT DOCUMENTS**

D. 381,995 \* 8/1997 Sumita ..... D16/202  
D. 388,106 \* 12/1997 Tanaka ..... D16/202

D. 390,243 \* 2/1998 Choi ..... D16/202  
D. 423,541 \* 4/2000 Ohwada ..... D16/202  
D. 429,742 \* 8/2000 Fukushima ..... D16/202  
5,499,052 \* 3/1996 Nakanishi et al. .... 348/373

\* cited by examiner

*Primary Examiner*—Adir Aronovich

(74) *Attorney, Agent, or Firm*—Fitzpatrick, Cella, Harper & Scinto

(57) **CLAIM**

The ornamental design for a video camera with video tape recorder, as shown and described.

**DESCRIPTION**

FIG. 1 is a front view of a video camera with video tape recorder showing our new design;  
FIG. 2 is a rear view thereof;  
FIG. 3 is a top plan view thereof;  
FIG. 4 is a bottom plan view thereof;  
FIG. 5 is a left side view thereof;  
FIG. 6 is a right side view thereof; and,  
FIG. 7 is a perspective view as viewed from right and front thereof.

**1 Claim, 5 Drawing Sheets**

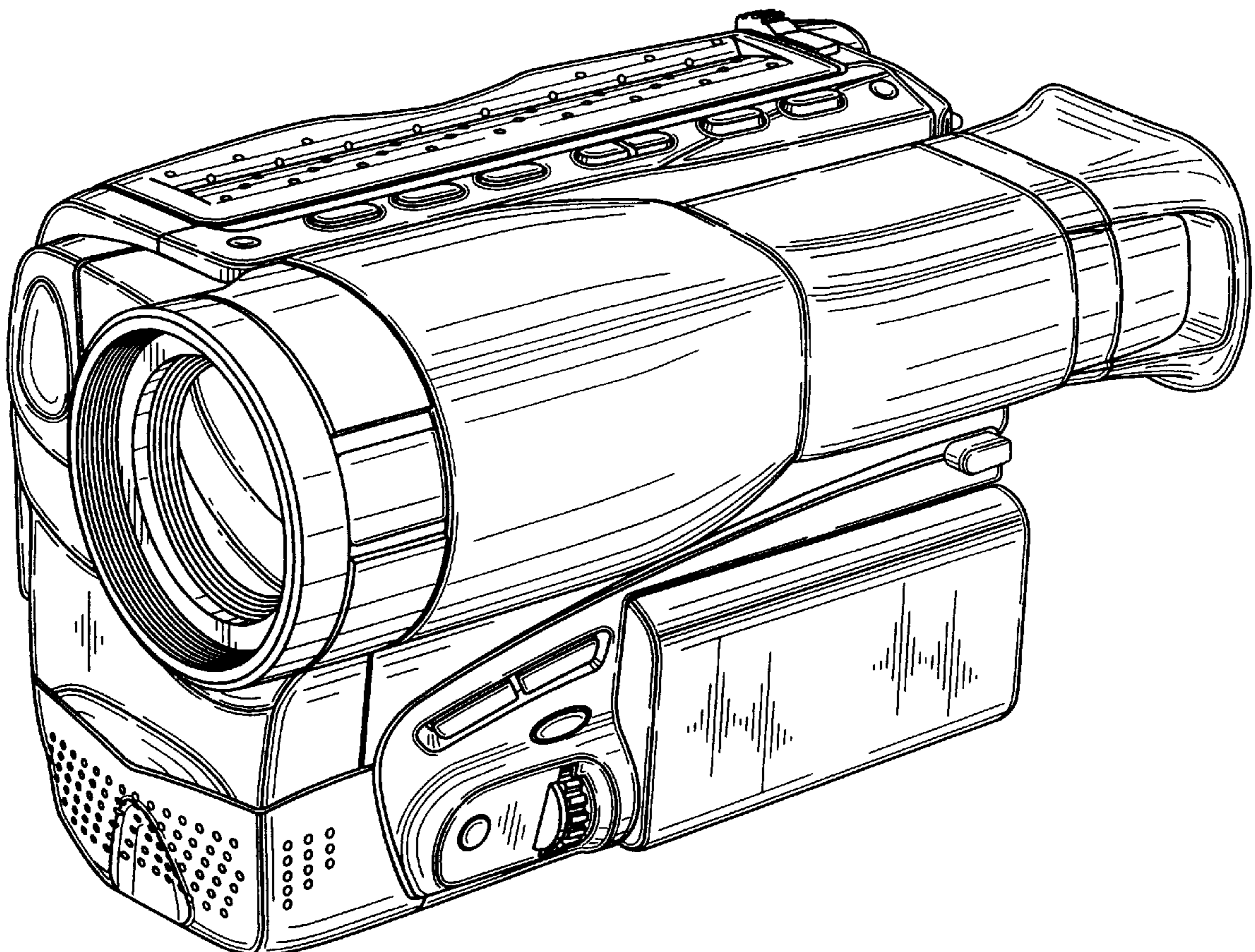

*FIG. 1*

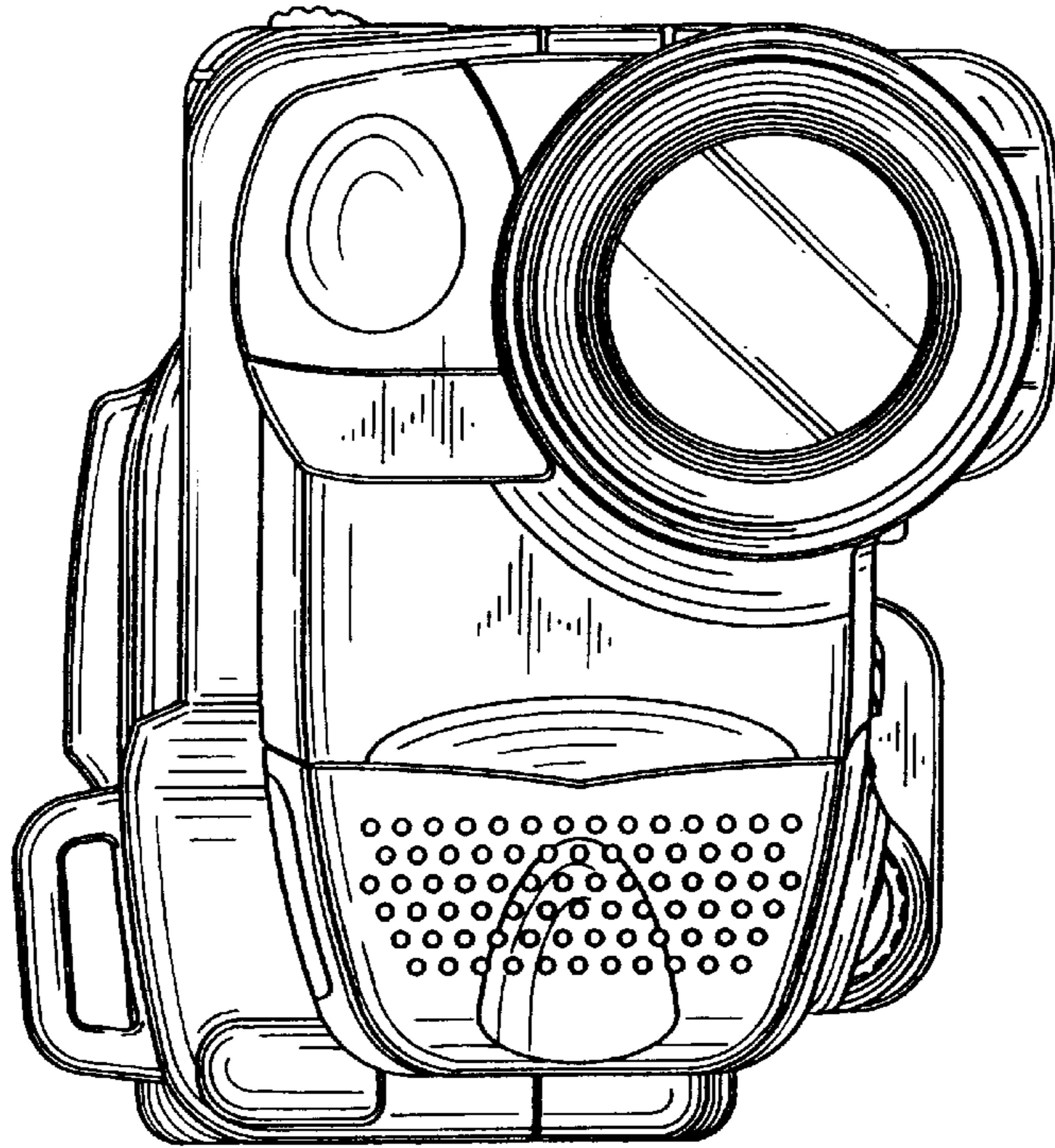

*FIG. 2*

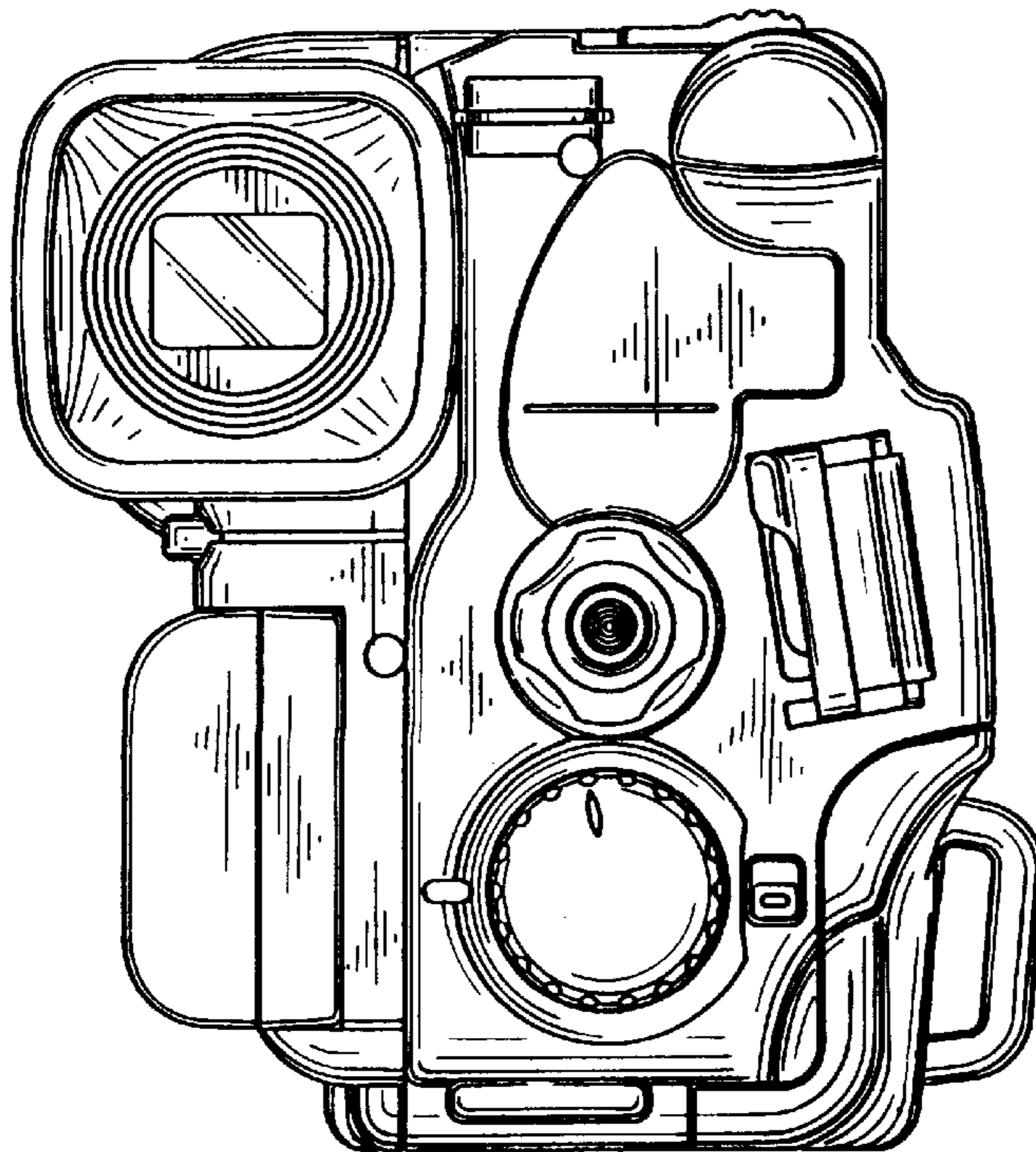

*FIG. 3*

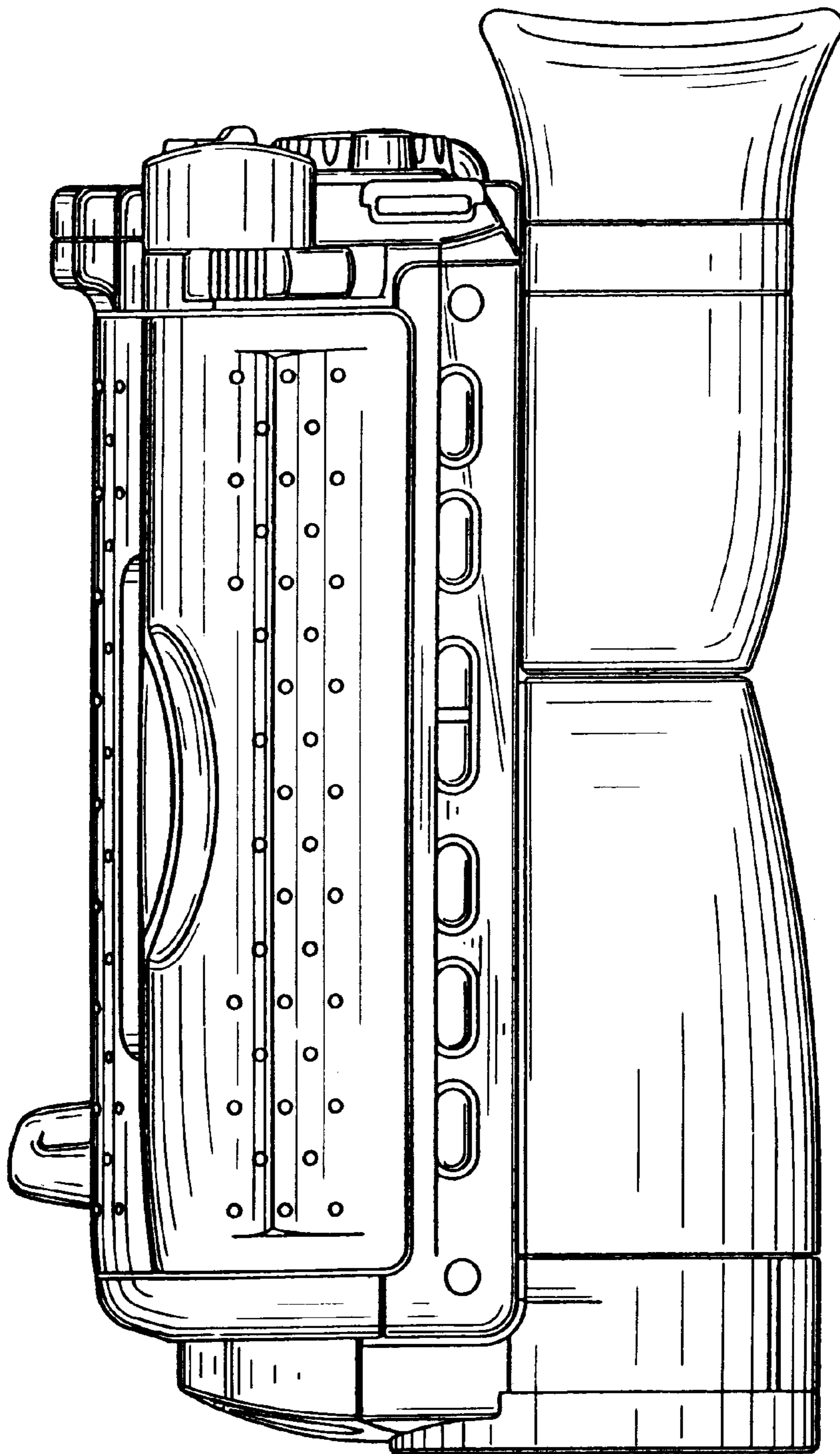

*FIG. 4*

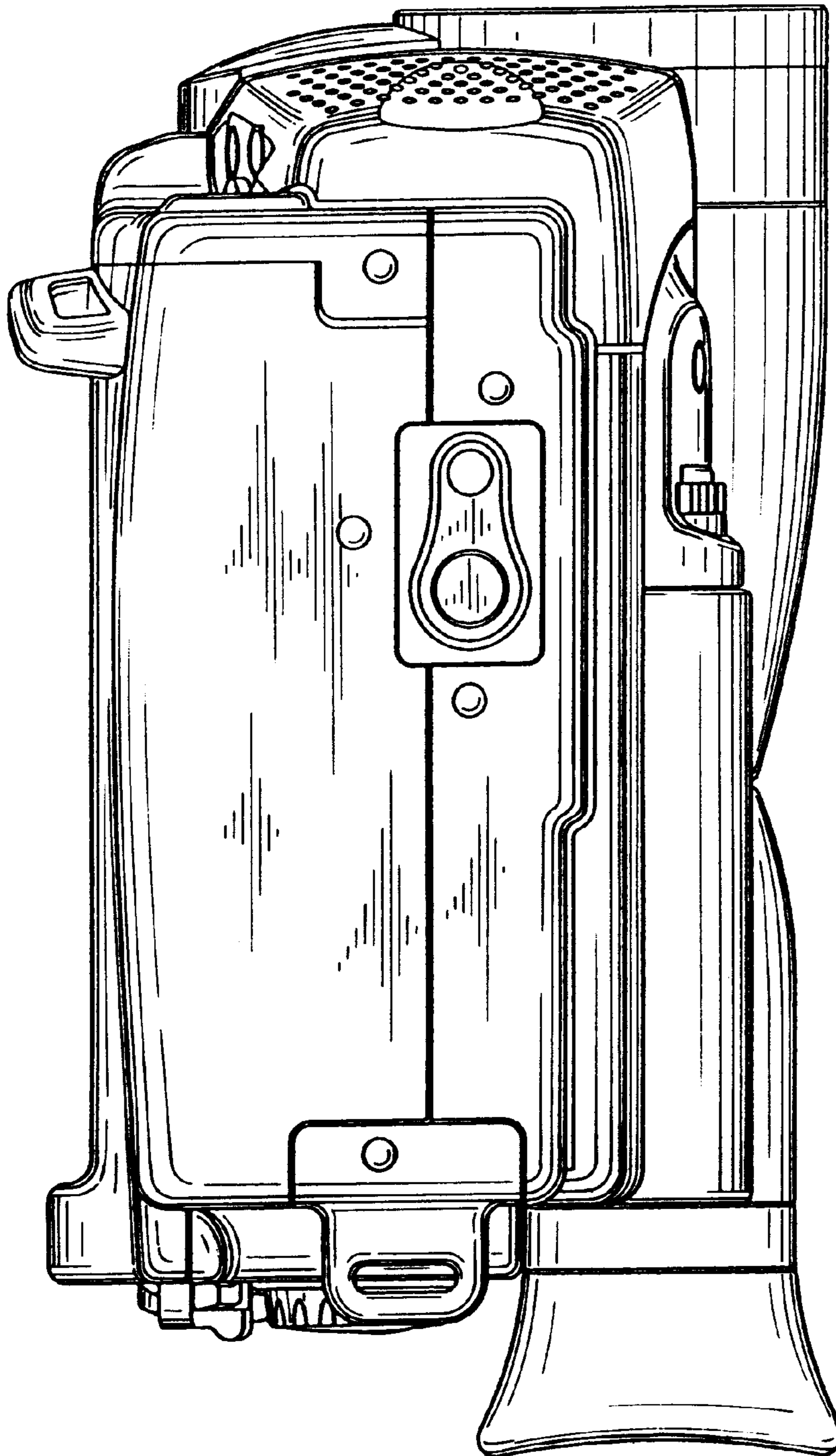

*FIG. 5*

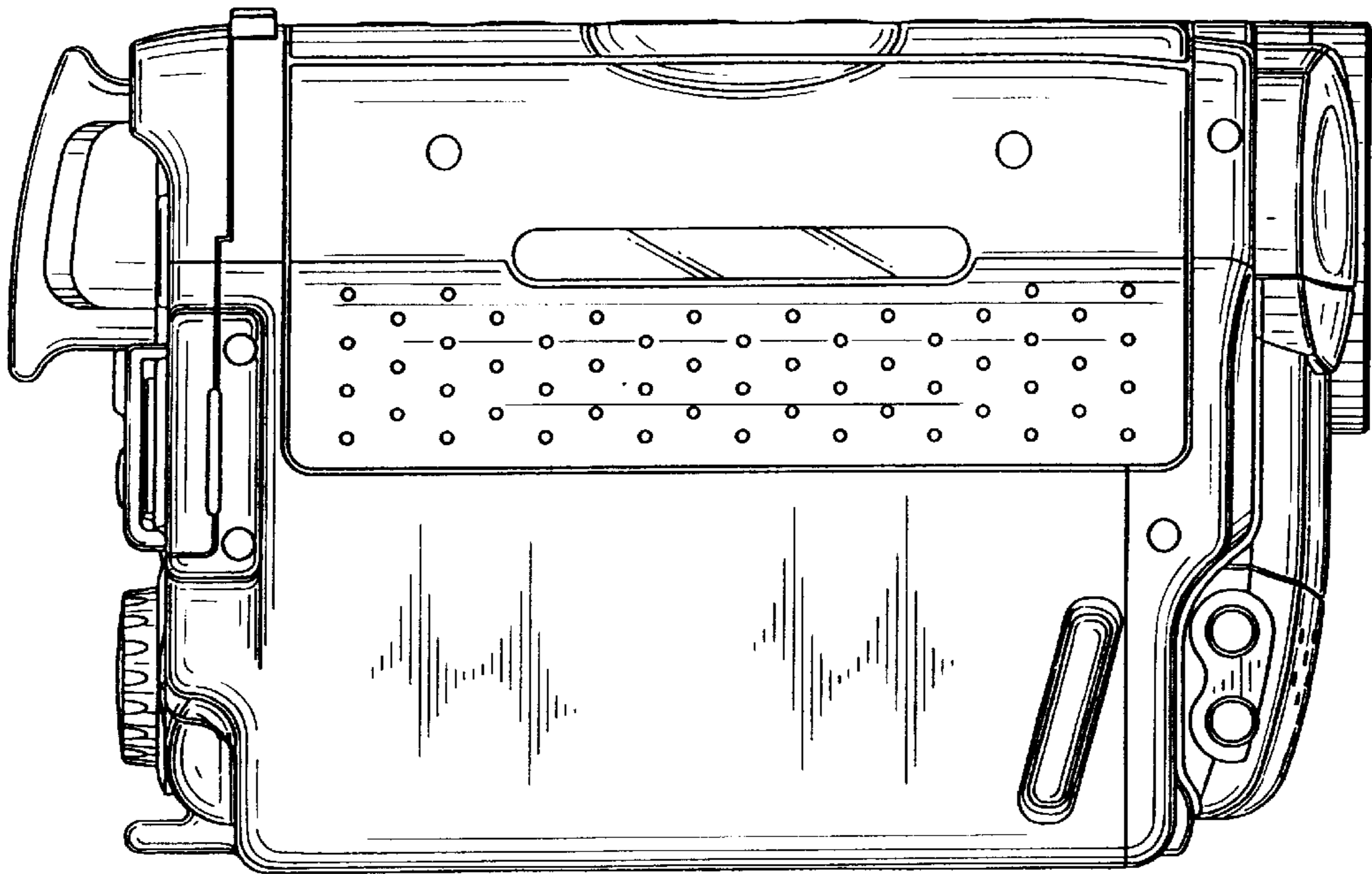

*FIG. 6*

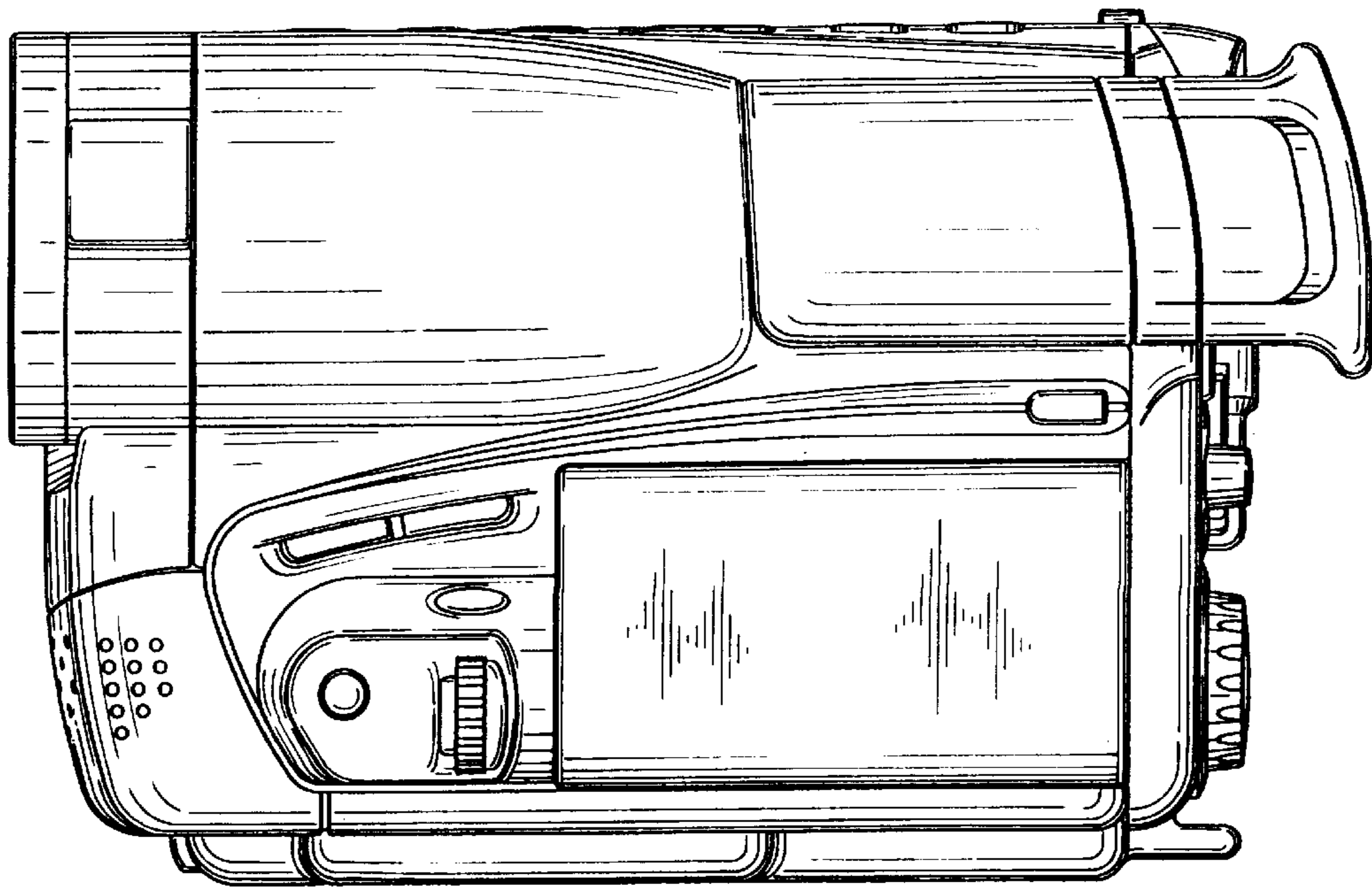

*FIG. 7*

