



US00D438536S

(12) **United States Design Patent**
Willison et al.

(10) **Patent No.:** **US D438,536 S**

(45) **Date of Patent:** **** Mar. 6, 2001**

(54) **CELLULAR PHONE HOLDER**

(75) Inventors: **Phillip Blake Willison**, Scottsdale;
Michael Sorenson, Fountain Hills;
Clyde McKay, Scottsdale, all of AZ
(US)

(73) Assignee: **International Components Corporation**, Chicago, IL (US)

(**) Term: **14 Years**

(21) Appl. No.: **29/110,231**

(22) Filed: **Sep. 1, 1999**

(51) **LOC (7) Cl.** **14-03**

(52) **U.S. Cl.** **D14/253; D8/373**

(58) **Field of Search** D14/137, 138,
D14/148, 147, 149-151, 140-142, 240,
241, 251, 253; 379/433-436, 419, 420,
428, 440, 454, 455, 446, 447; D13/107,
108; 320/110, 113, 114, 115; D8/373, 363;
224/271, 666, 197; 24/597, 3.12; D3/218

(56) **References Cited**

U.S. PATENT DOCUMENTS

D. 301,685	*	6/1989	Vories	D8/373
D. 318,707	*	7/1991	Barrow	D22/107
D. 378,290		3/1997	Hahn	.	
D. 378,291		3/1997	Hahn	.	
D. 379,003		4/1997	Hahn	.	
D. 381,314		7/1997	Hahn	.	
D. 382,540		8/1997	Hahn	.	
D. 384,937		10/1997	Liu	.	
D. 404,038	*	1/1999	Fransson et al.	D14/253
681,392	*	8/1901	Fugate	224/271
757,343	*	4/1904	Patterson	224/157
3,868,571	*	2/1975	Greiner	455/88
3,878,589	*	4/1975	Schaefer	24/669
4,151,467	*	4/1979	Kongelka et al.	455/35.1
4,378,603		3/1983	Eastmond	.	
4,419,794	*	12/1983	Horton, Jr. et al.	24/667
4,642,859	*	2/1987	Kaiser	24/669
4,718,586	*	1/1988	Hagino	224/666

4,737,976		4/1988	Borth et al.	.	
5,014,892	*	5/1991	Copeland	224/271
5,054,170	*	10/1991	Otrusina	24/597
5,109,410		4/1992	Suhani et al.	.	
5,201,858	*	4/1993	Otrusina	24/597
5,347,693	*	9/1994	Otrusina	24/597
5,375,749	*	12/1994	Oliva	224/271
5,407,113		4/1995	Golliher	.	
5,433,416	*	7/1995	Johnson	248/475.1
5,507,667		4/1996	Hahn et al.	.	
5,551,613	*	9/1996	Malinowski	224/666
5,568,365		10/1996	Hahn et al.	.	
5,597,102	*	1/1997	Saarikko et al.	224/197
5,610,979	*	3/1997	Yu	379/455
5,611,701		3/1997	Hahn	.	
5,613,222		3/1997	Guenther	.	
5,620,120	*	4/1997	Tien	224/199
5,626,496		5/1997	Hahn	.	

(List continued on next page.)

Primary Examiner—Jeffrey Asch

(74) *Attorney, Agent, or Firm*—Katten Muchin Zavis

(57) **CLAIM**

The ornamental design for a cellular phone holder, as shown and described.

DESCRIPTION

FIG. 1 is a perspective view of a cellular phone holder in accordance with the present invention.

FIG. 2 is a reduced bottom view of the cellular phone holder shown in FIG. 1.

FIG. 3 is a reduced top view of the cellular phone holder illustrated in FIG. 1.

FIG. 4 is a reduced side-elevational view of the cellular phone holder illustrated in FIG. 1.

FIG. 5 is a reduced opposing side-elevational view relative to FIG. 4 of the cellular phone holder illustrated in FIG. 1.

FIG. 6 is a reduced front view of the cellular phone holder illustrated in FIG. 1; and,

FIG. 7 is a reduced rear view of the cellular phone holder illustrated in FIG. 1.

1 Claim, 3 Drawing Sheets

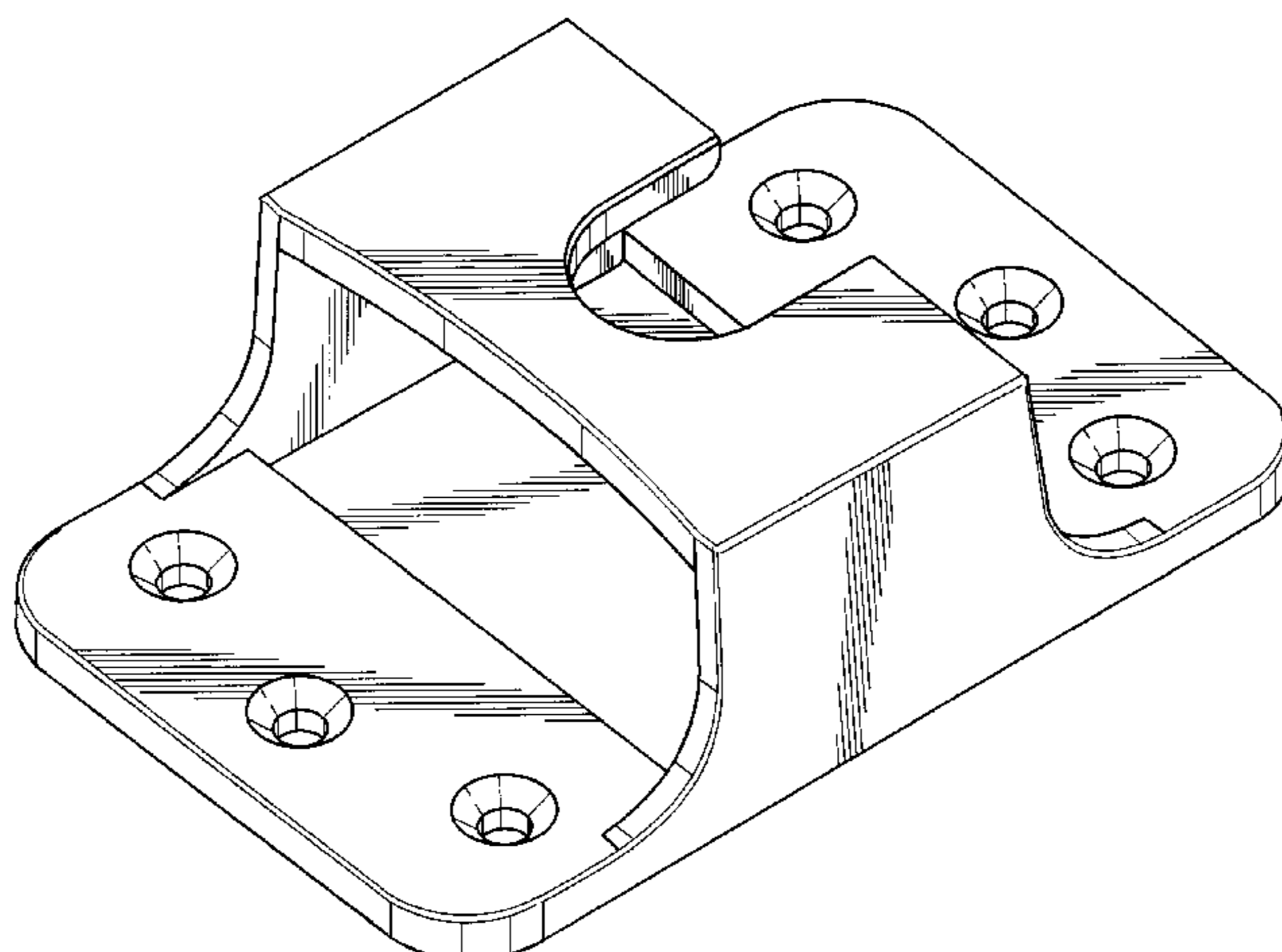

US D438,536 S

Page 2

U.S. PATENT DOCUMENTS

5,628,641	5/1997	Hahn .	5,839,173	*	11/1998	Otrusina	24/597
5,634,806	6/1997	Hahn .	5,841,856		11/1998	Ide .	
5,648,712	7/1997	Hahn .	5,847,541		12/1998	Hahn .	
5,659,236	8/1997	Hahn .	5,850,954	*	12/1998	Dong-Joo	224/197
5,689,558	11/1997	Osgood et al. .	5,850,996	*	12/1998	Liang	248/221.11
5,764,627	6/1998	Sharma et al. .	5,884,191		3/1999	Karpus et al. .	
5,787,168	*	7/1998	Lien		3/1999	Shiraki .	
5,799,847	*	9/1998	Sandor		5/1999	Jensen	24/3.12
5,802,167		9/1998	Hong .				

* cited by examiner

Fig. 1

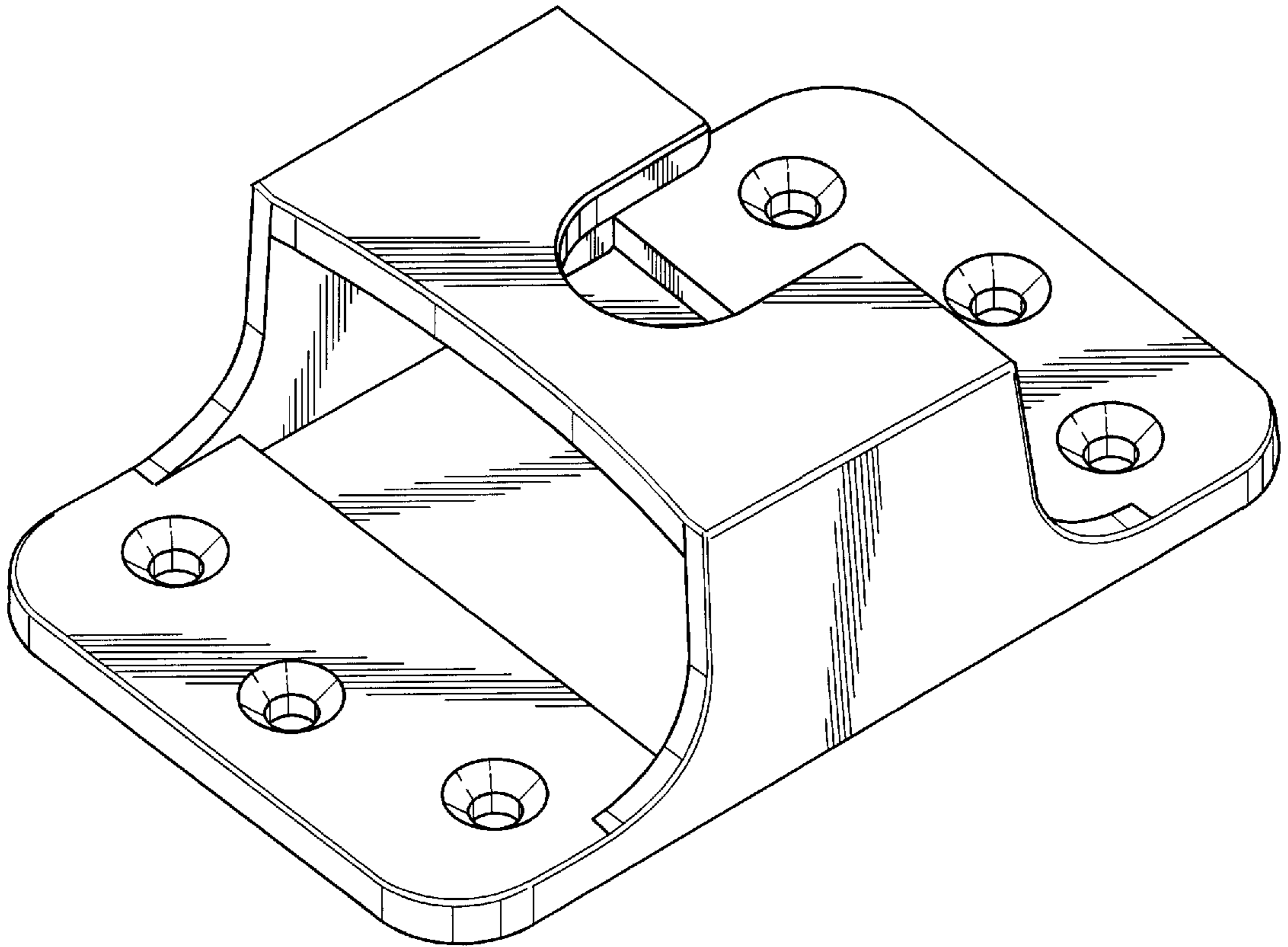

Fig. 2

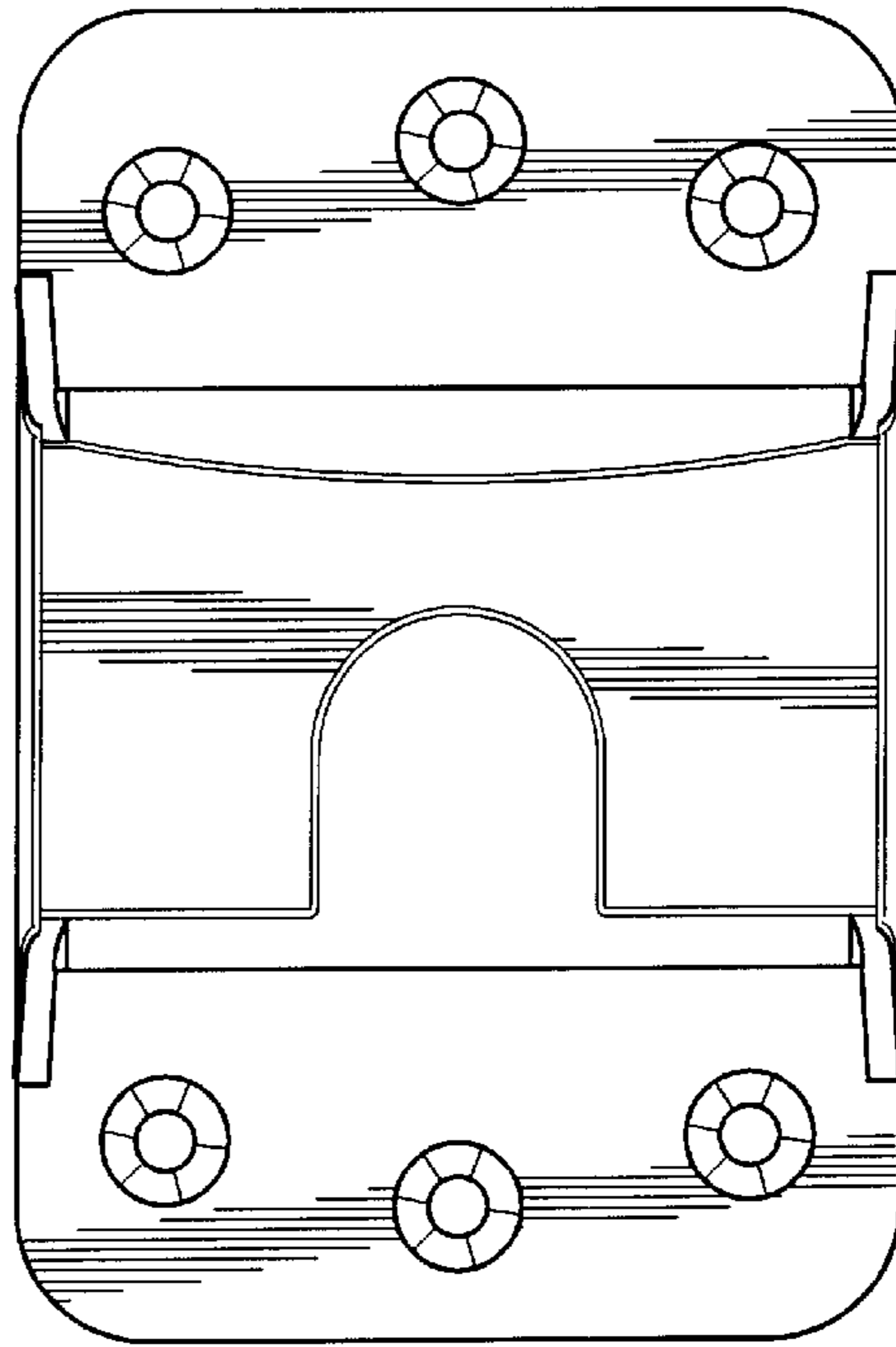

Fig. 3

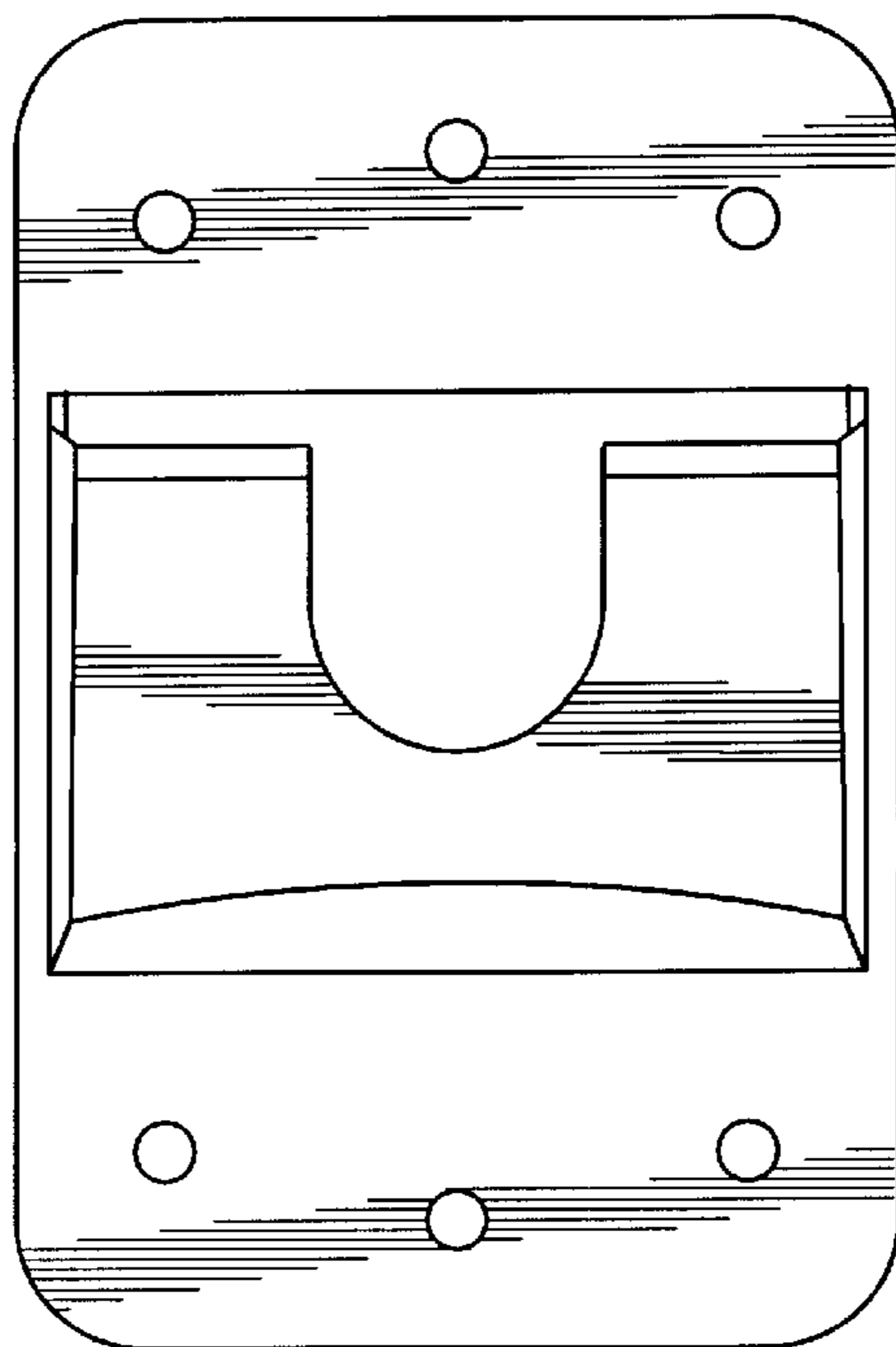

Fig. 4

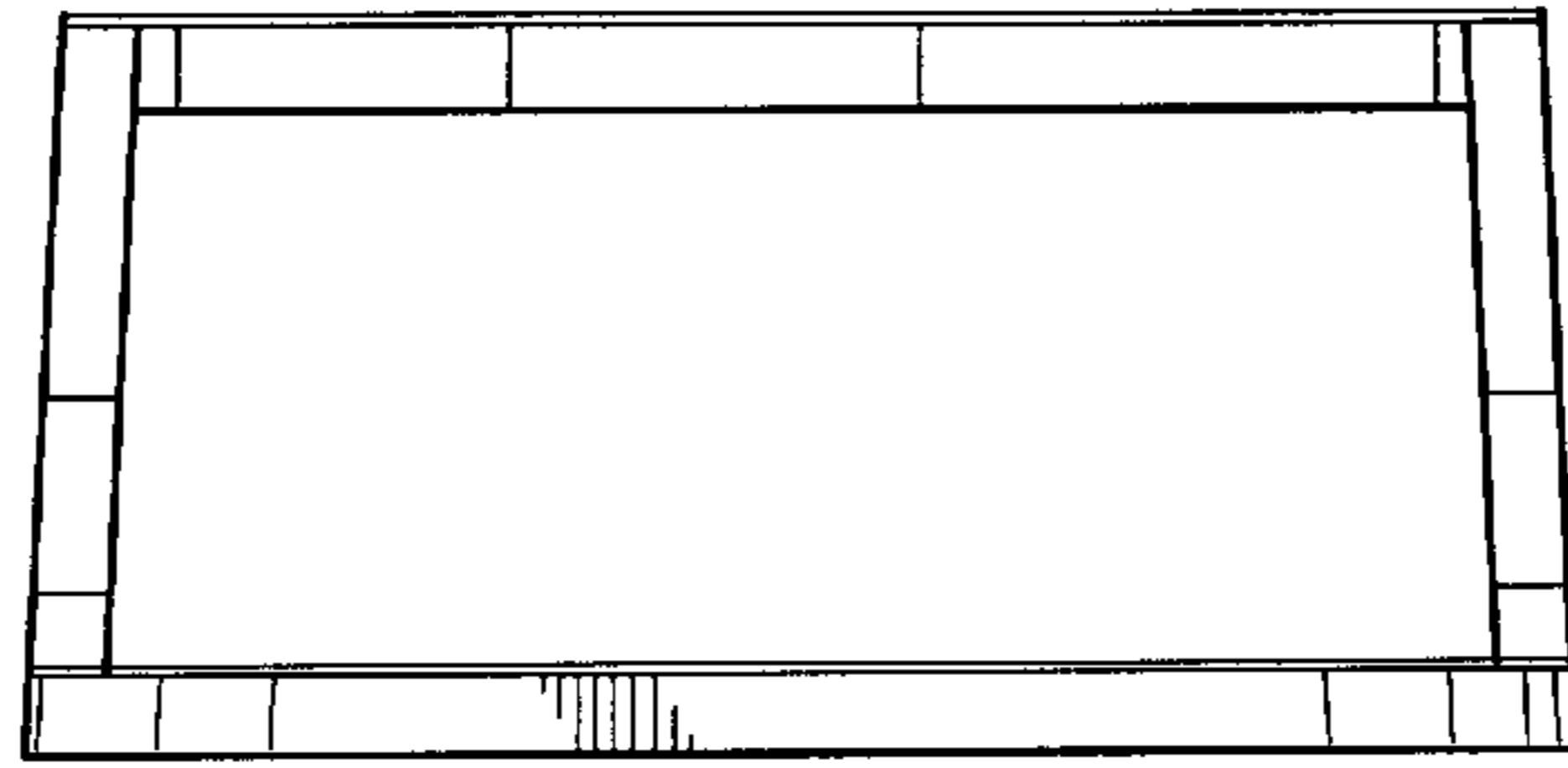

Fig. 5

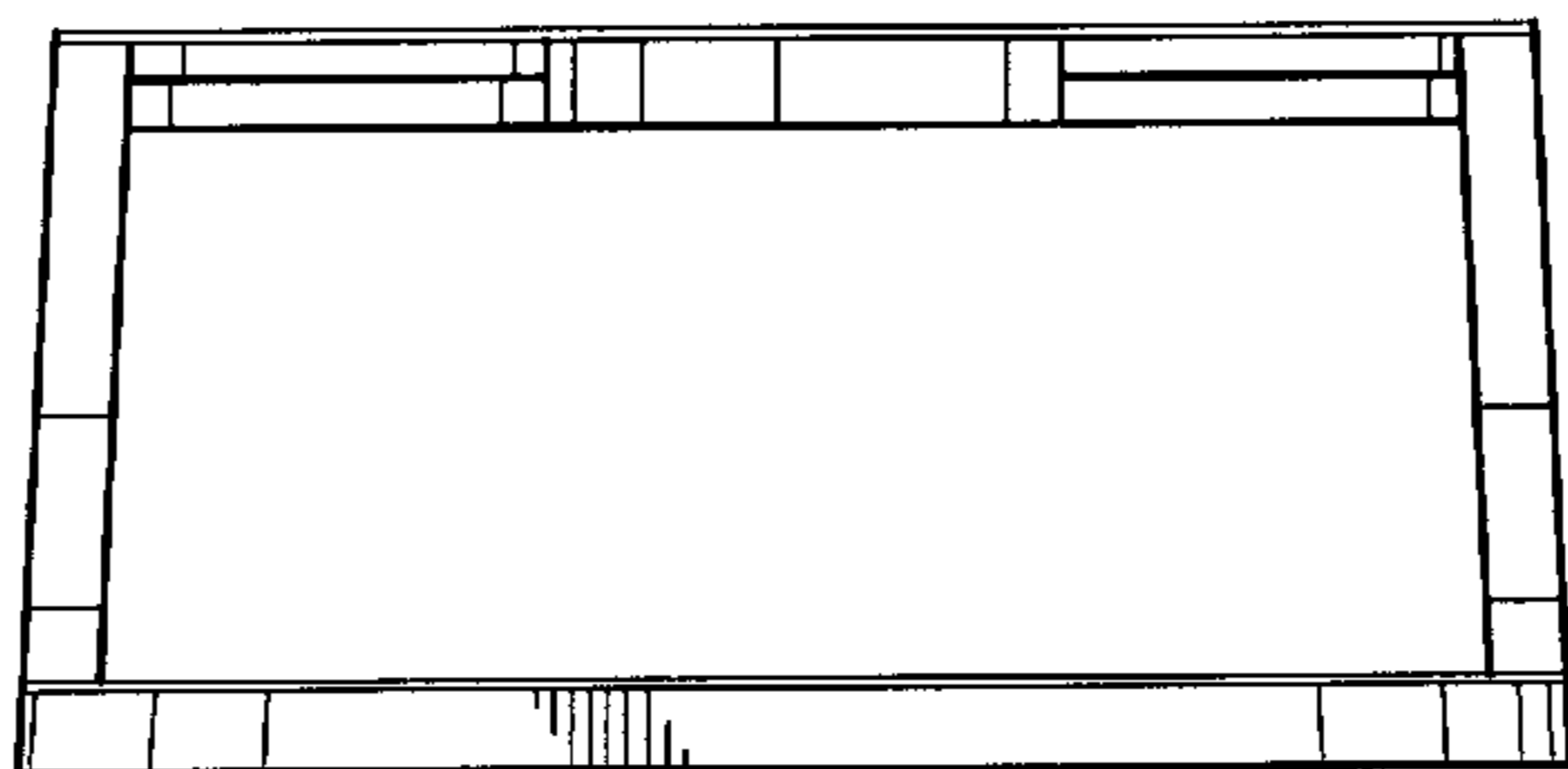

Fig. 6

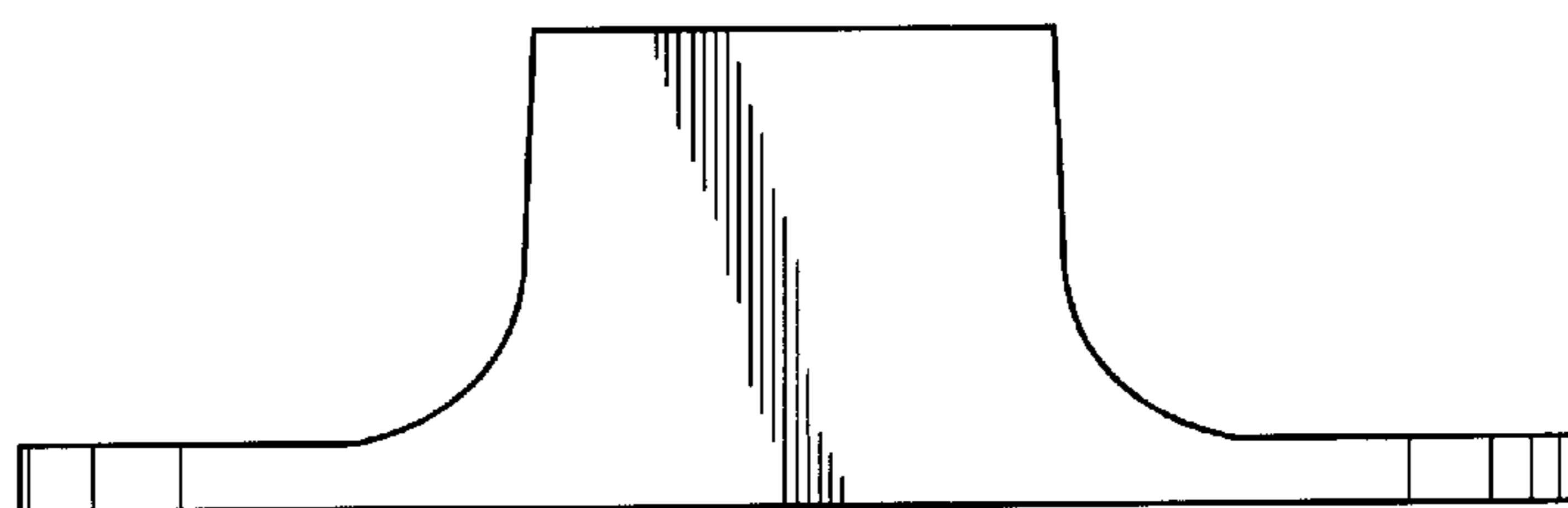

Fig. 7

