



US00D438426S

(12) **United States Design Patent**
Yu et al.

(10) **Patent No.:** **US D438,426 S**

(45) **Date of Patent:** **** Mar. 6, 2001**

(54) **HANDLE FOR COOKING VESSEL**

D. 367,584 * 3/1996 Koch D7/394

(75) Inventors: **Jai Won Yu**, Seoul (KR); **Hyun Seok Kim**, Mt. Prospect, IL (US)

* cited by examiner

(73) Assignees: **Saekwang Aluminum Co., Ltd.**, Ansan (KR); **Master Cookware Corporation**, Chicago, IL (US)

Primary Examiner—Caron D. Veynar

(74) *Attorney, Agent, or Firm*—Ladas & Parry

(**) Term: **14 Years**

(57) **CLAIM**

The ornamental design for a handle for cooking vessel, as shown.

(21) Appl. No.: **29/100,088**

DESCRIPTION

(22) Filed: **Feb. 3, 1999**

FIG. 1 is a front view of the handle for a cooking vessel showing our design;

(51) **LOC (7) Cl.** **07-02**

FIG. 2 is a rear view thereof;

(52) **U.S. Cl.** **D7/394**

FIG. 3 is a right view (left view the same) thereof;

(58) **Field of Search** D7/354-361, 393-395; 220/573.1, 752, 755, 760, 912; D8/107

FIG. 4 is a top view thereof;

FIG. 5 is a bottom view thereof;

(56) **References Cited**

FIG. 6 is a perspective view thereof; and,

FIG. 7 is a cross-section taken along line 7-7 in FIG. 1.

U.S. PATENT DOCUMENTS

D. 59,534 * 11/1921 Barchoff D8/107

1 Claim, 5 Drawing Sheets

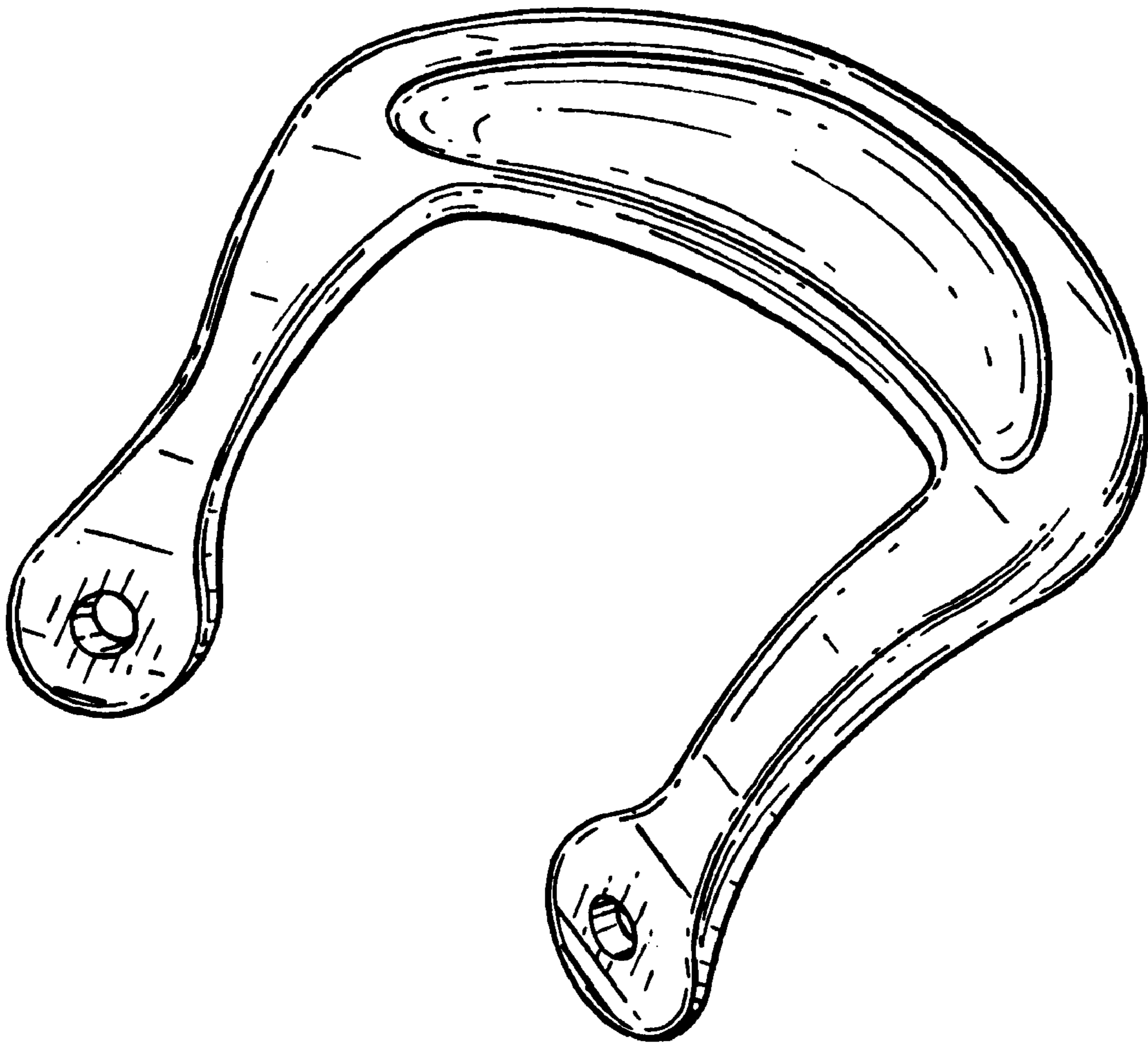

FIG.1

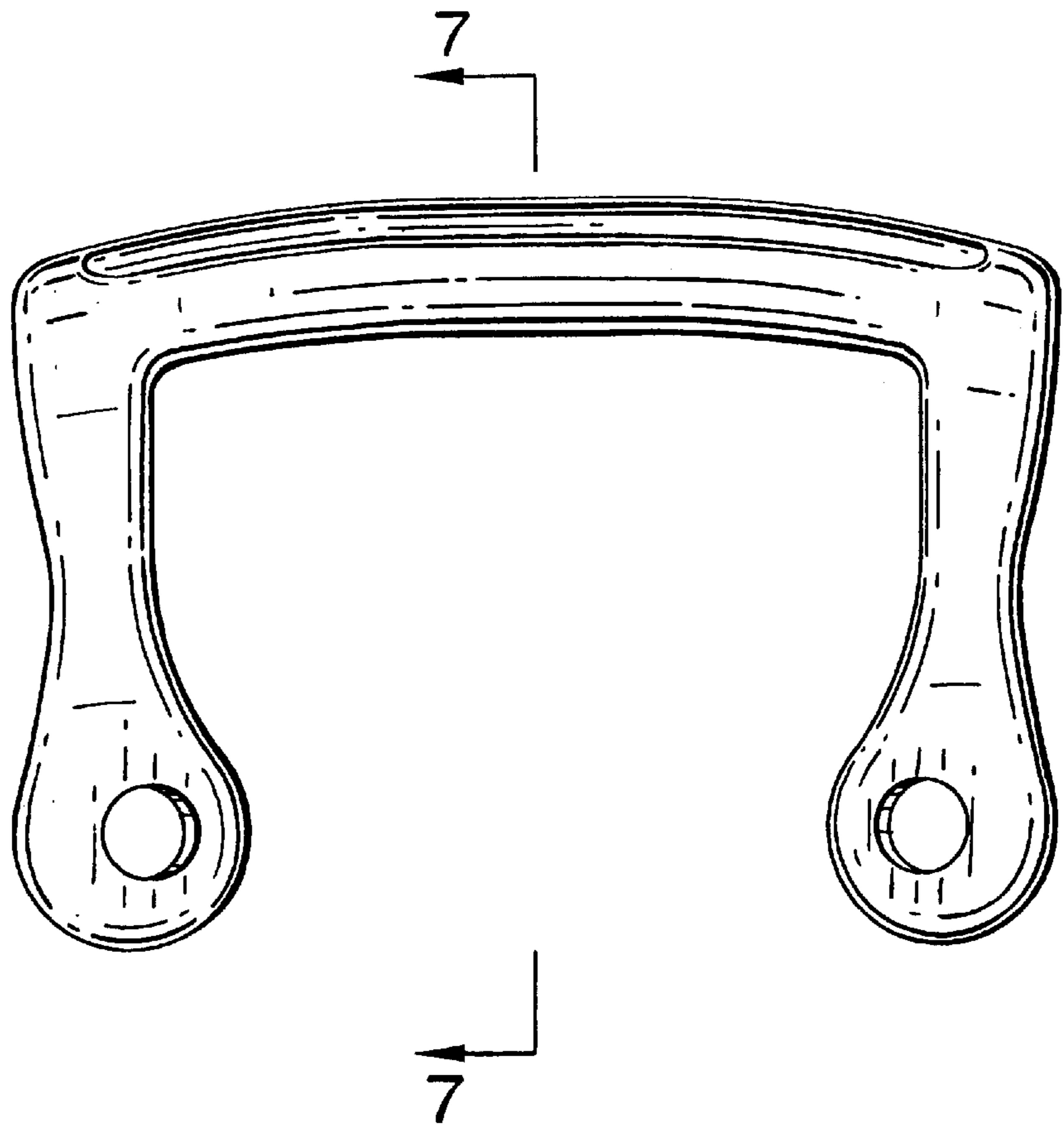

FIG.2

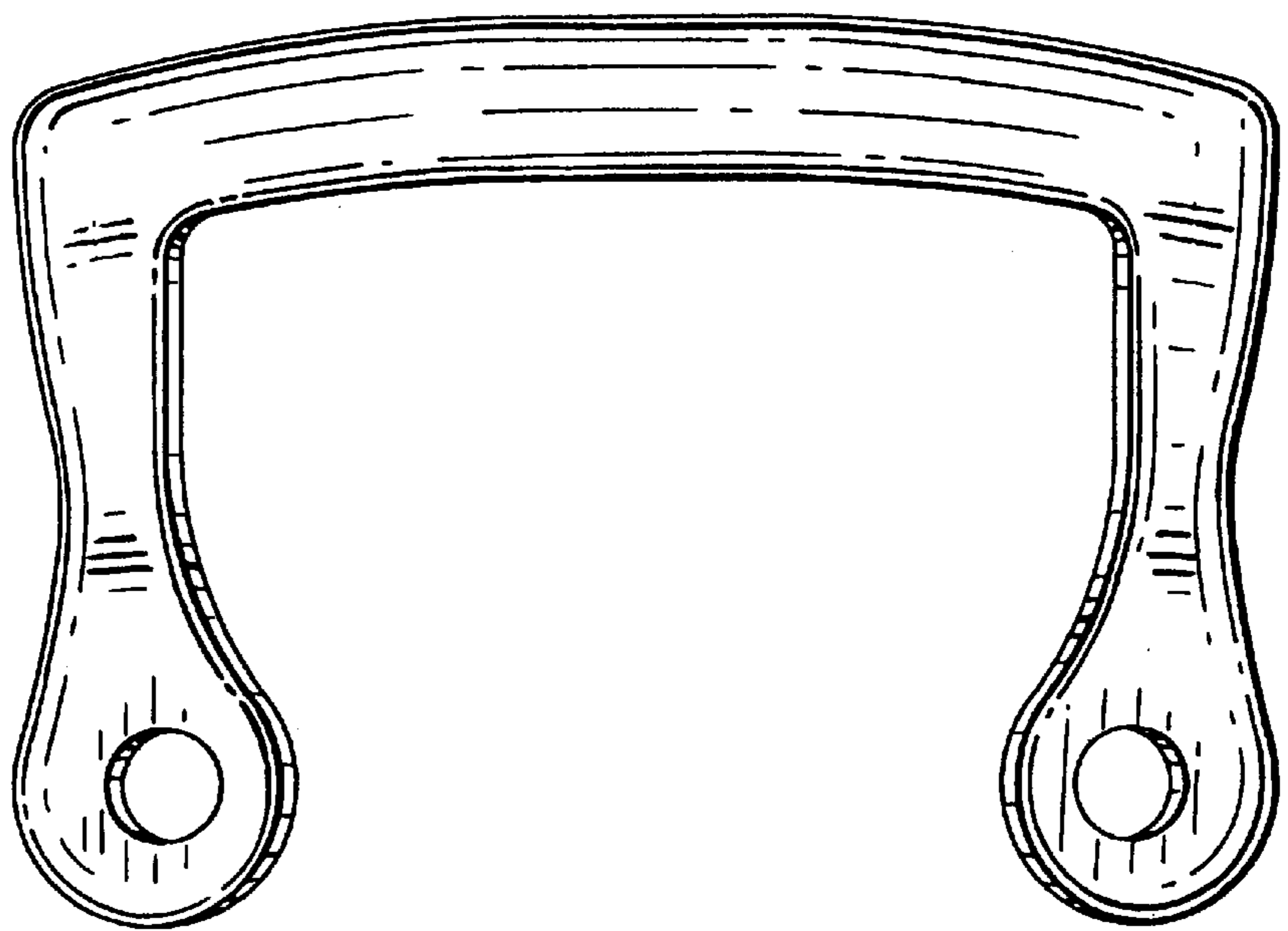

FIG.3

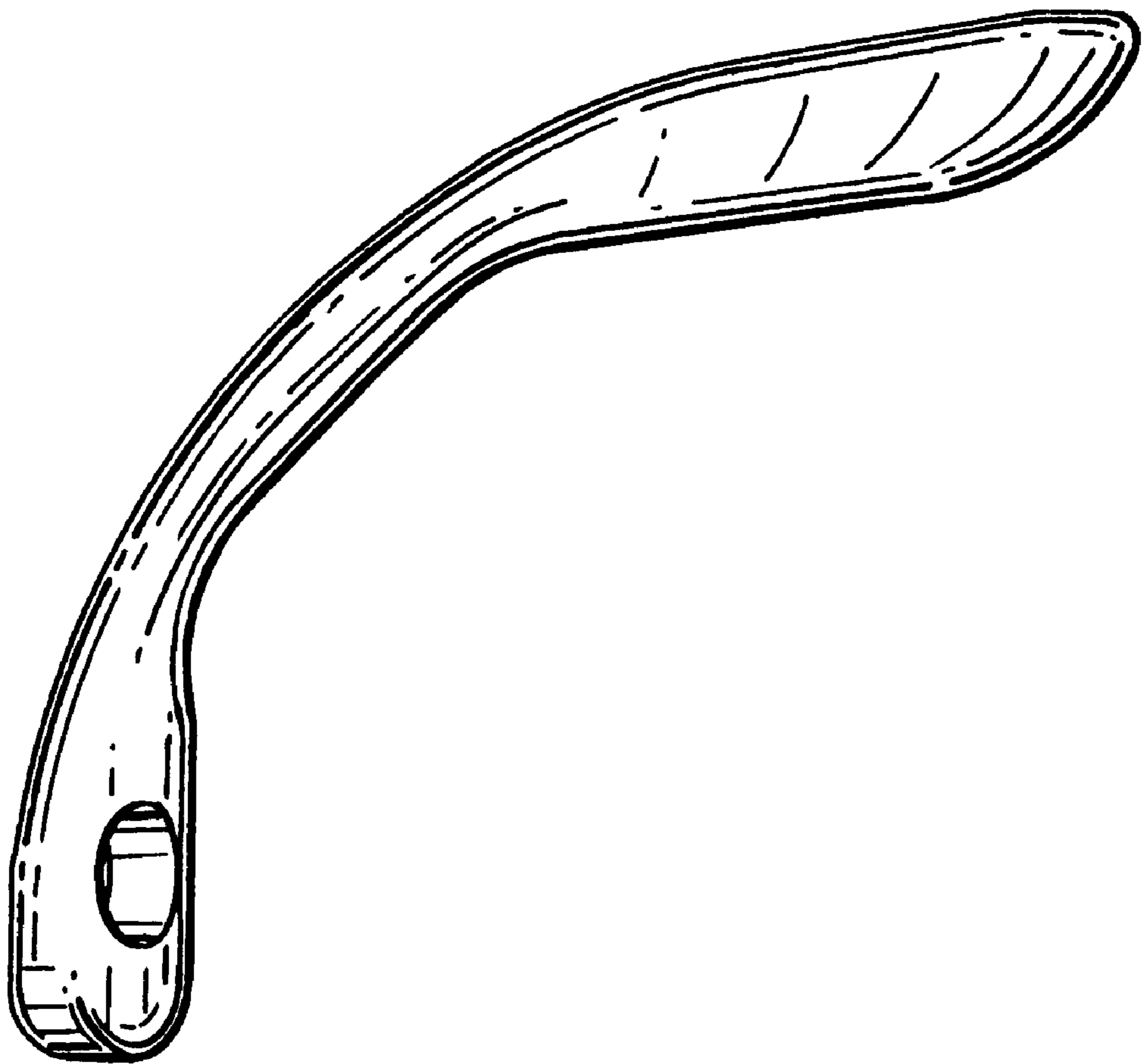

FIG.4

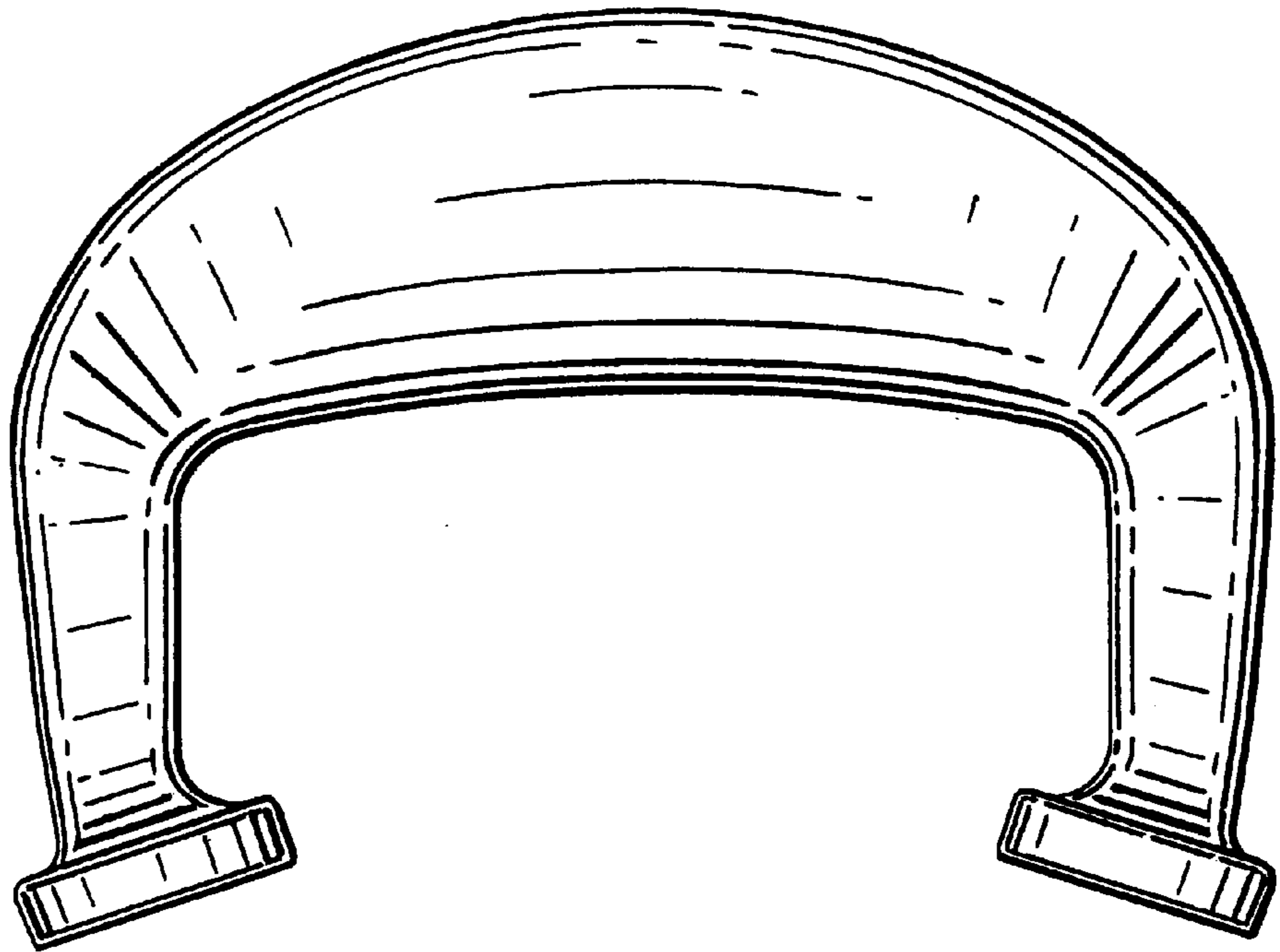

FIG.5

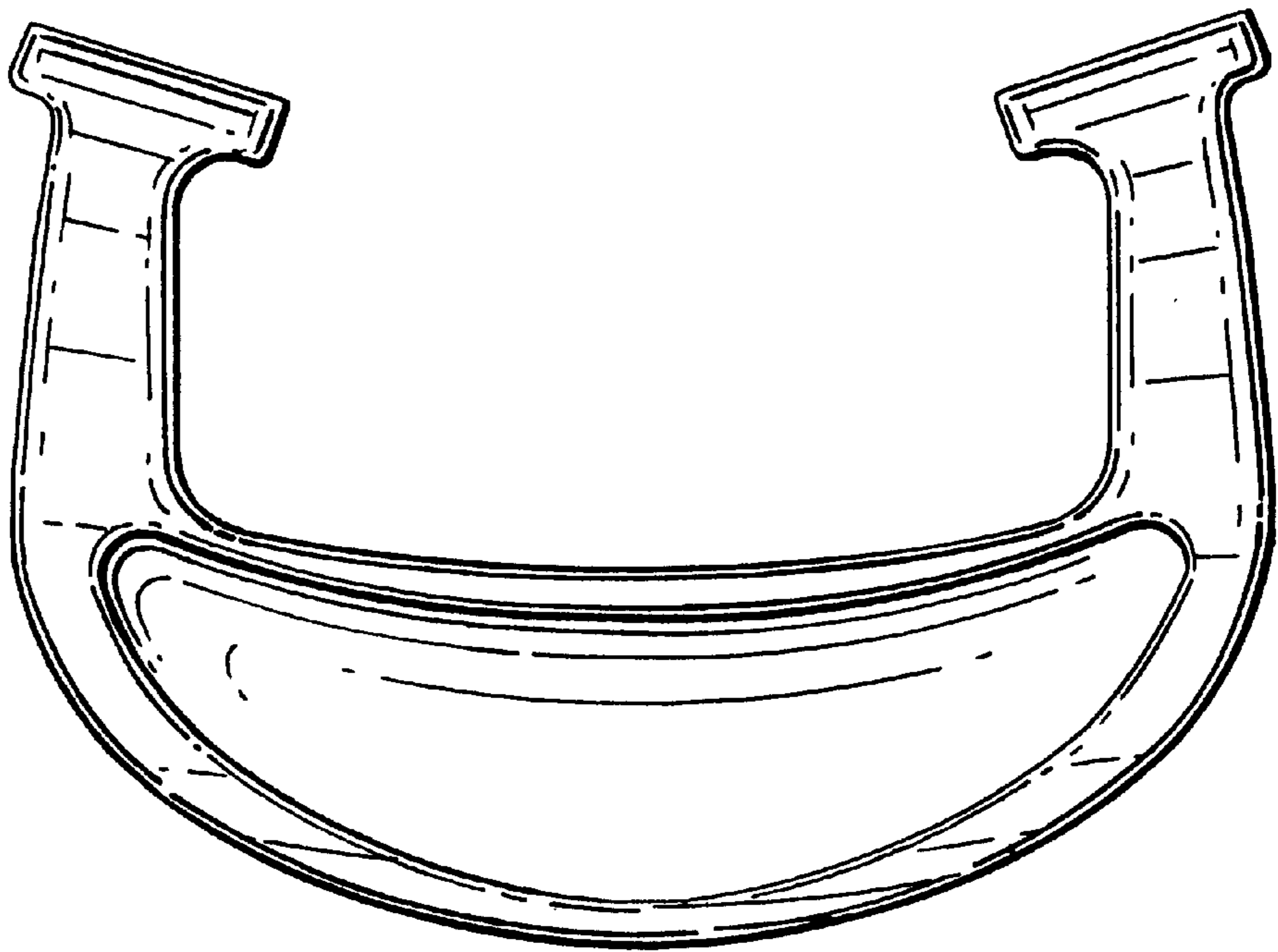

FIG.6

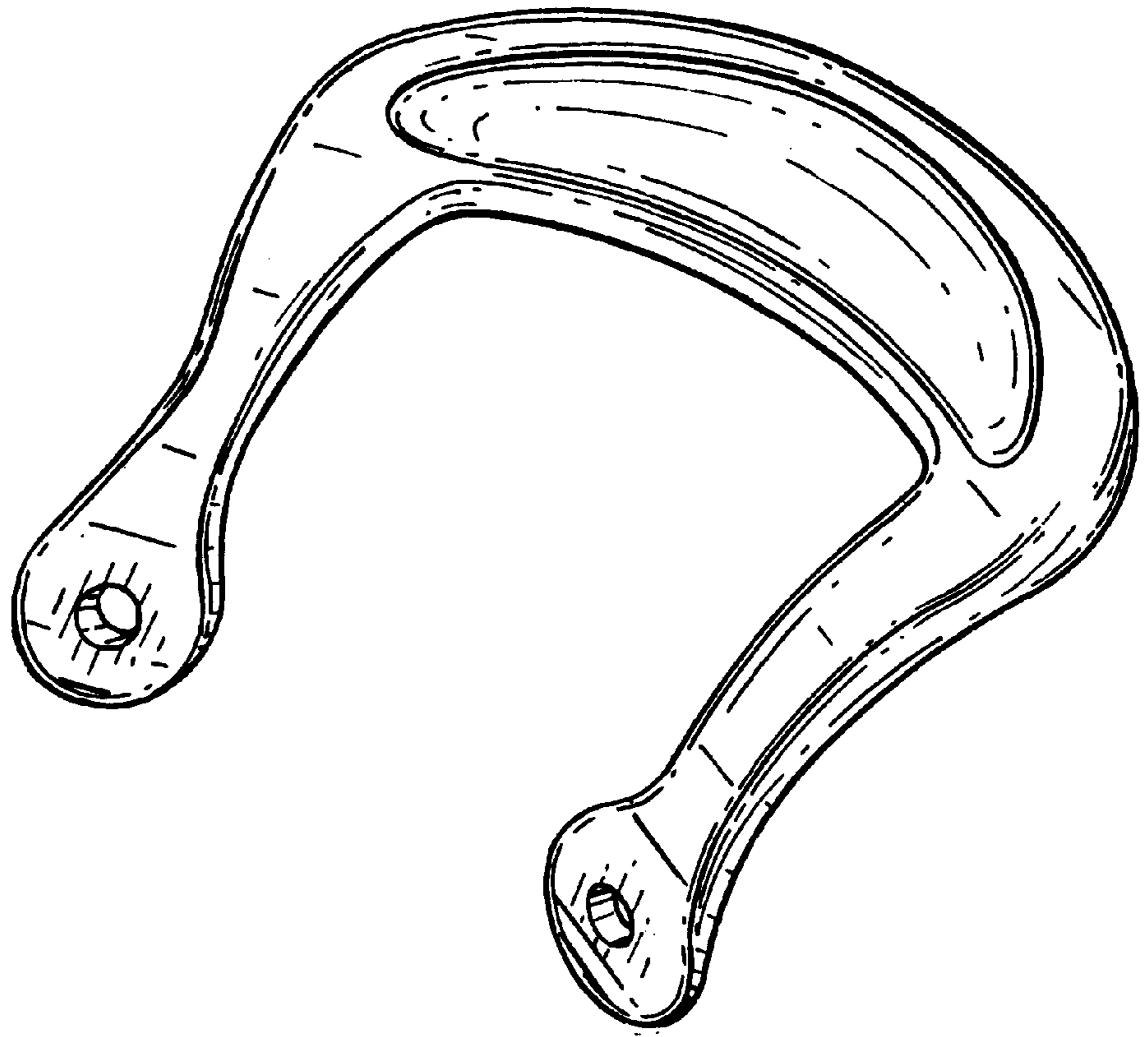

FIG. 7

