



US00D438375S

(12) **United States Design Patent**
Terry

(10) **Patent No.:** **US D438,375 S**

(45) **Date of Patent:** **** Mar. 6, 2001**

(54) COSMETIC BAG	2,533,850	12/1950	Syracuse	150/34
	3,759,356	9/1973	Bostick	190/42
(75) Inventor: Katherine Klemmer Terry , New York, NY (US)	4,301,898	11/1981	Plough	190/152
	4,961,522	10/1990	Weber	224/151
	5,265,719	11/1993	Wand	206/223
(73) Assignee: Revlon Consumer Products Corporation , New York, NY (US)	5,813,445	9/1998	Christman	150/106
	5,826,714	10/1998	Martin	206/232
	5,868,227	2/1999	Garcia	190/112

(**) Term: **14 Years**

* cited by examiner

(21) Appl. No.: **29/120,476**

Primary Examiner—Louis S. Zarfaz

(22) Filed: **Mar. 20, 2000**

Assistant Examiner—Monica Weingart

(51) **LOC (7) Cl.** **03-01**

(74) *Attorney, Agent, or Firm*—Julie Blackburn

(52) **U.S. Cl.** **D3/233; D3/245; D3/901**

(57) **CLAIM**

(58) **Field of Search** D3/232, 233, 245,
D3/246, 301, 901; 150/100, 107, 117, 118,
109, 110, 112, 127; 190/100, 109, 111,
115, 118, 119, 903

The ornamental design for a cosmetic bag, as shown and described.

DESCRIPTION

(56) **References Cited**

FIG. 1: is a front perspective view of the cosmetic bag in accordance with the invention.

U.S. PATENT DOCUMENTS

FIG. 2: is a front view of the cosmetic bag.

D. 125,508	*	2/1941	Pichel	D3/246
D. 263,897	*	4/1982	Thornton	D3/243
D. 380,087		6/1997	Roth	D3/243
D. 423,771	*	5/2000	Gomez et al.	D3/205
922,567		5/1909	Cosgrove .	
1,979,987	*	11/1934	Martin	190/115
2,512,101	*	6/1950	Hack	150/107

FIG. 3: is a rear view of the cosmetic bag.

FIG. 4: is a right side view of the cosmetic bag.

FIG. 5: is a left side view of the cosmetic bag.

FIG. 6: is a top plan view of the cosmetic bag; and,

FIG. 7: is a bottom plan view of the cosmetic bag.

1 Claim, 5 Drawing Sheets

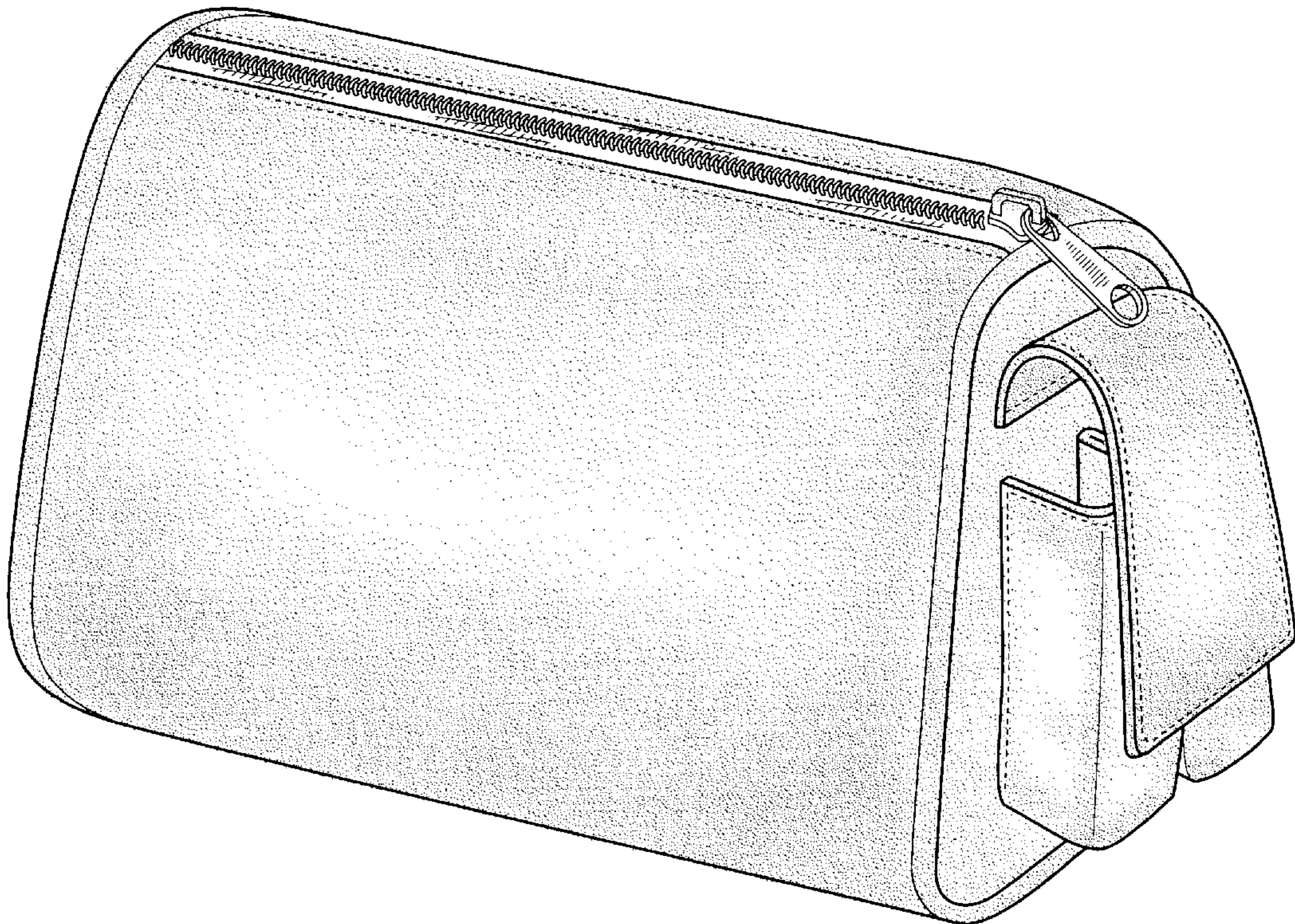

FIG. 1

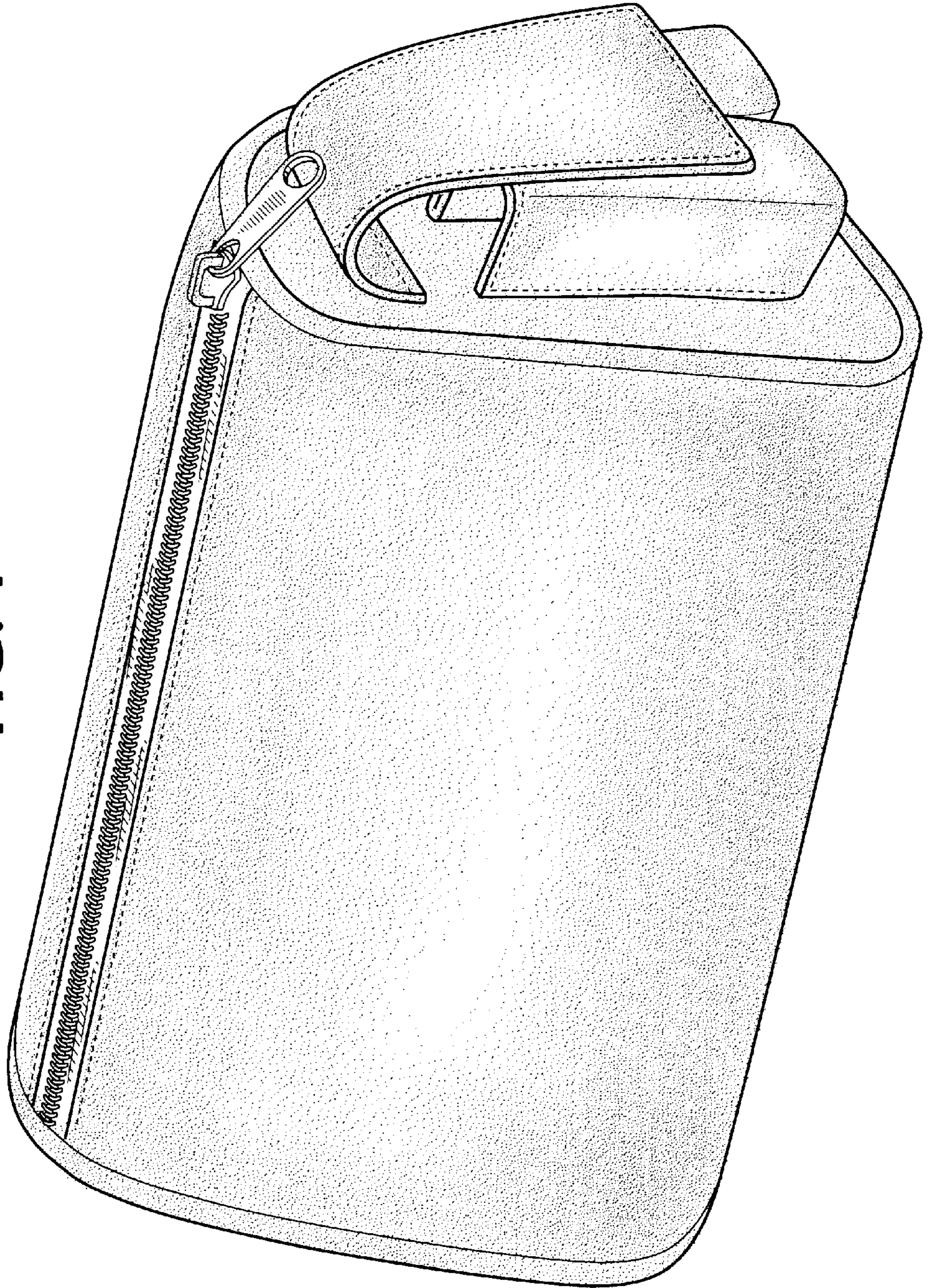

FIG. 2

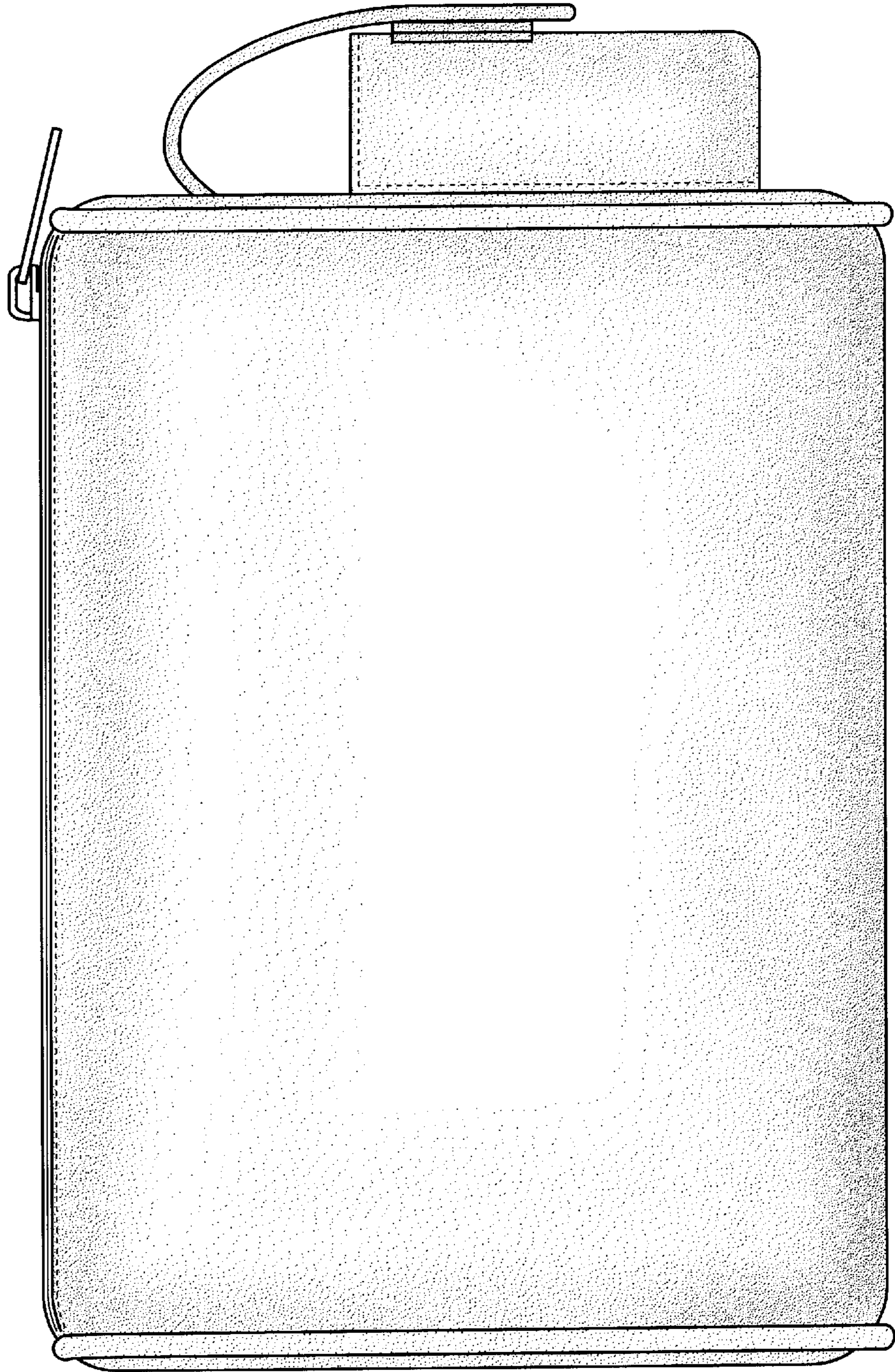

FIG. 3

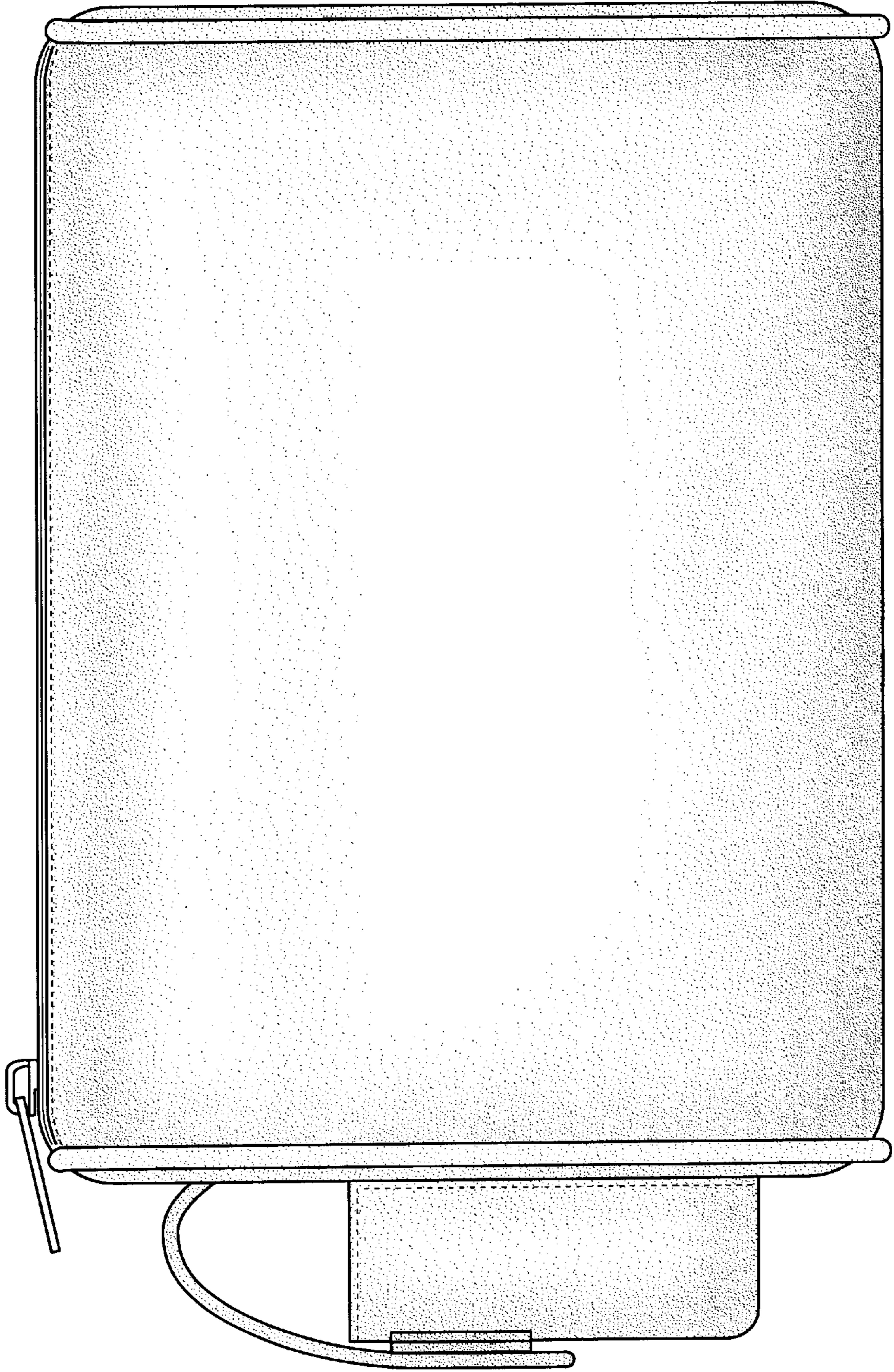

FIG. 5

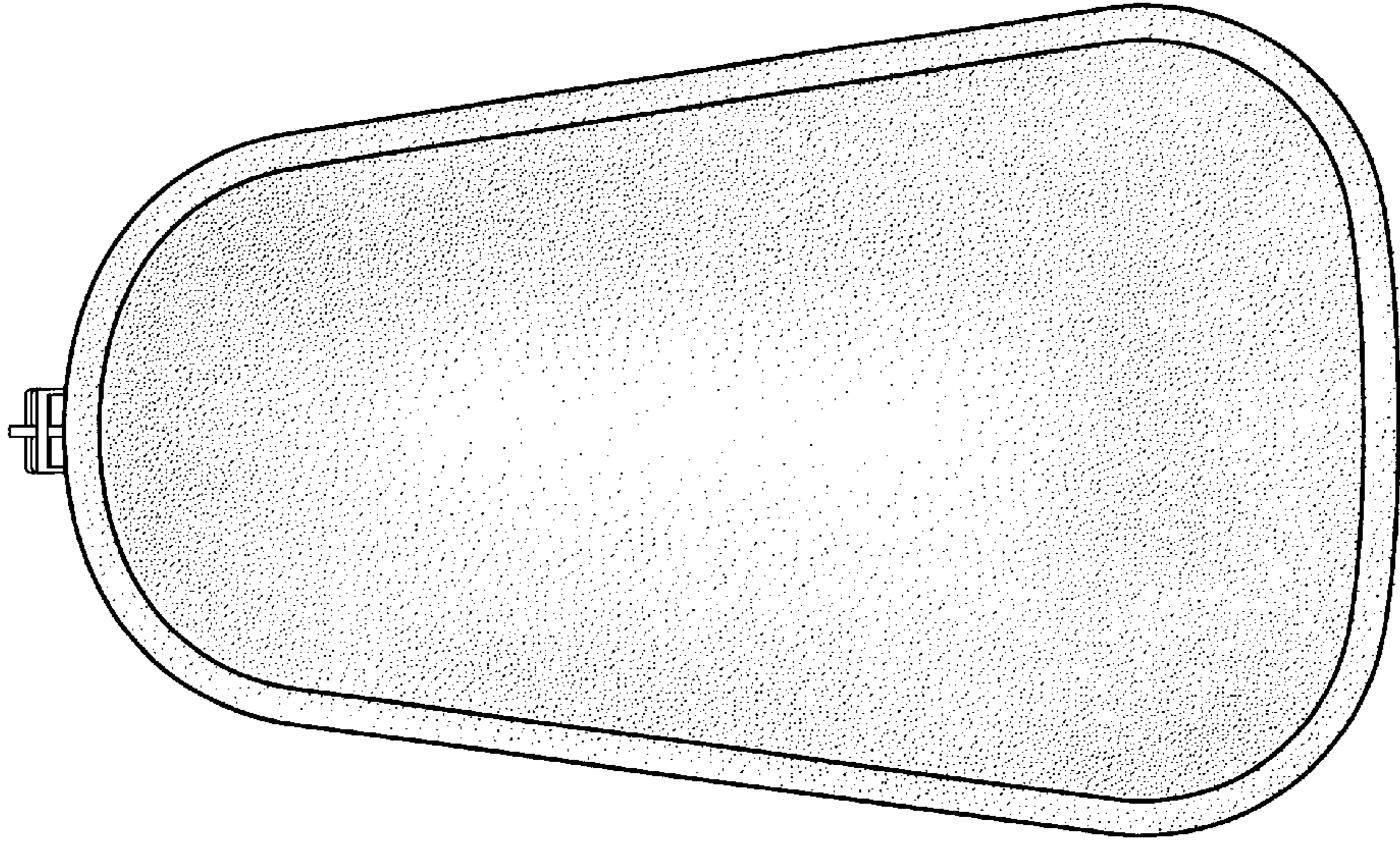
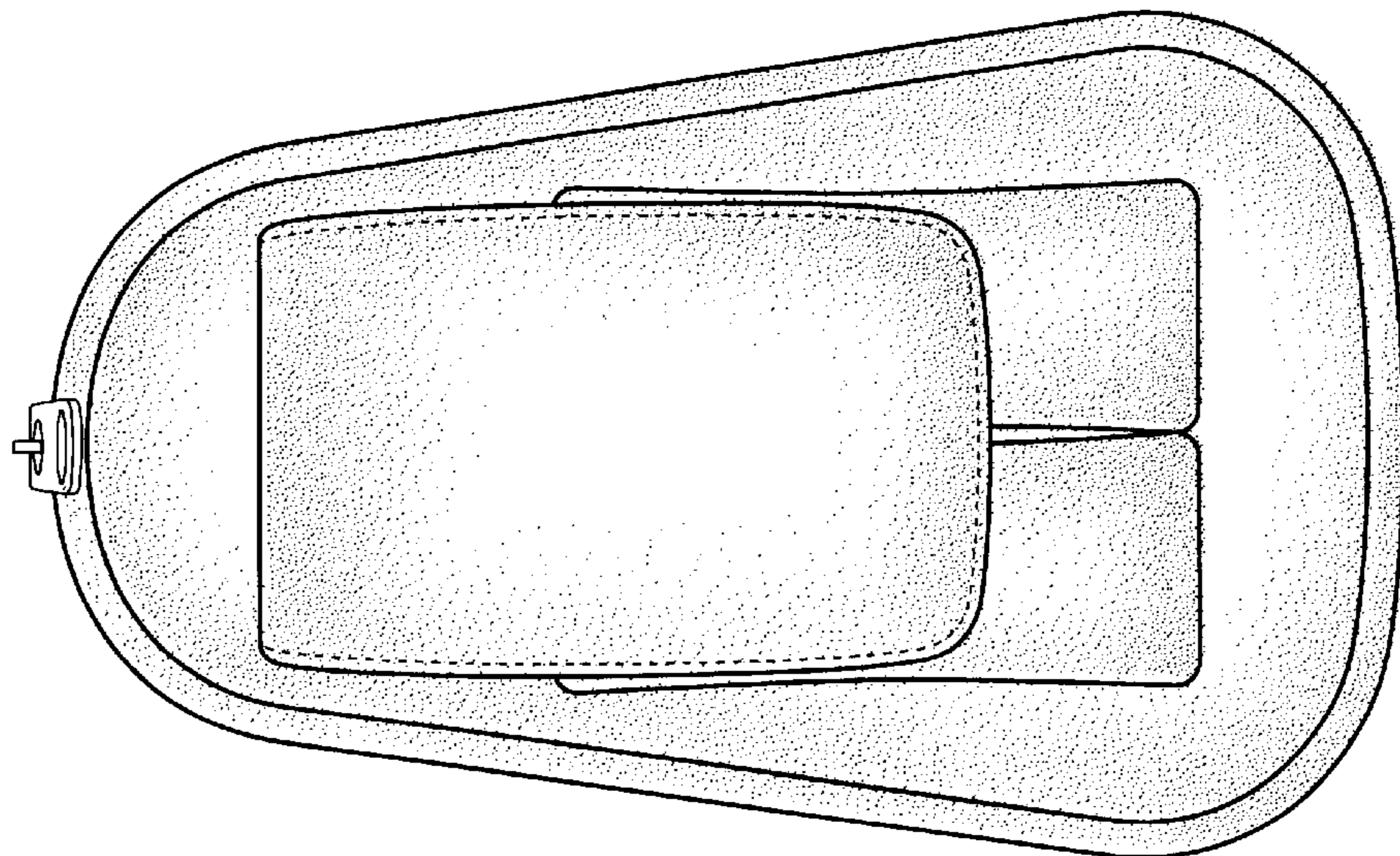

FIG. 4



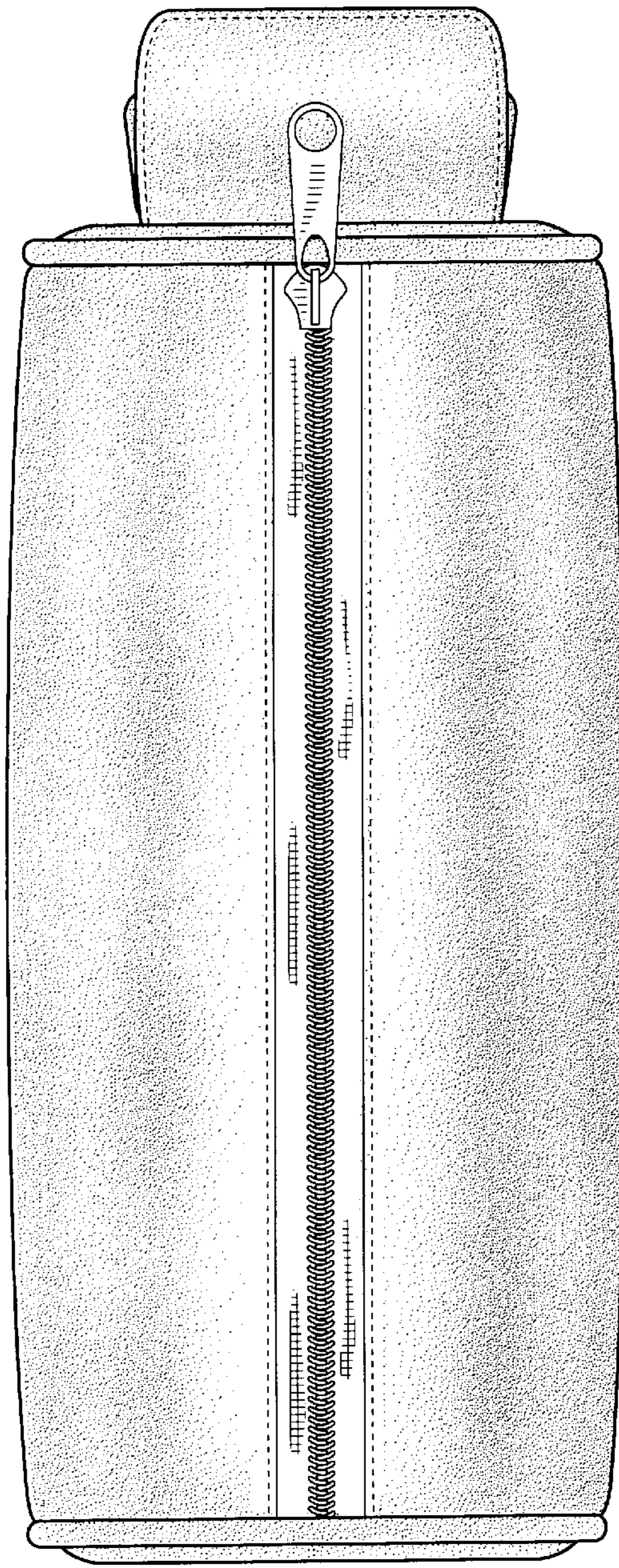

FIG. 6

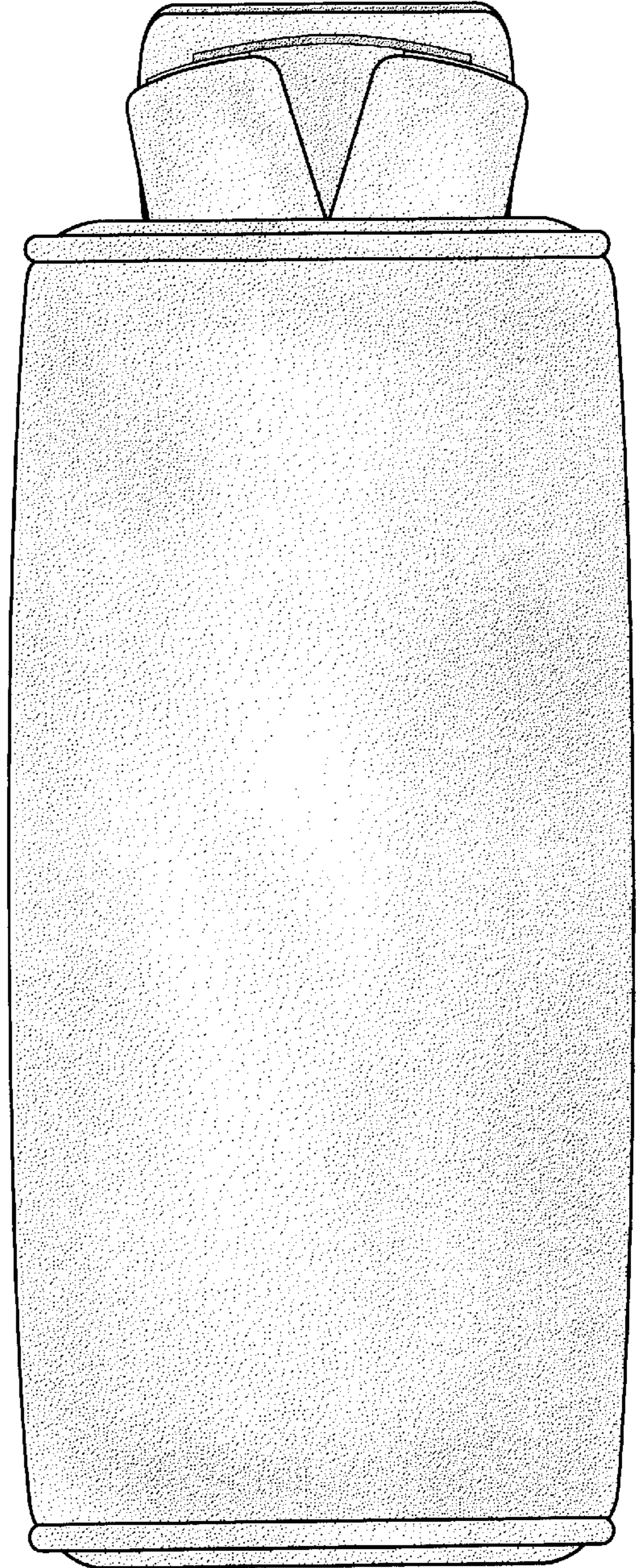

FIG. 7