



US00D438258S

(12) **United States Design Patent**
Itoh et al.

(10) **Patent No.:** **US D438,258 S**

(45) **Date of Patent:** **** Feb. 27, 2001**

- (54) **ELECTRONIC DISPLAY BOARD**
- (75) Inventors: **Kazuo Itoh; Osamu Nagata**, both of Aichi-ken; **Tsugio Okamoto**, Kani; **Osamu Takagi**, Nagoya, all of (JP)
- (73) Assignee: **Brother Industries, Ltd.**, Nagoya (JP)
- (**) Term: **14 Years**

D. 424,538 * 5/2000 Hayashi et al. D20/10
* cited by examiner

Primary Examiner—Marcus A. Jackson
(74) *Attorney, Agent, or Firm*—Oliff & Berridge, PLC

(57) **CLAIM**

The ornamental design for electronic display board, as shown and described.

DESCRIPTION

FIG. 1 is a front view of the electronic display board;
 FIG. 2 is a left side view thereof;
 FIG. 3 is a right side view thereof;
 FIG. 4 is a top view thereof;
 FIG. 5 is a bottom view thereof;
 FIG. 6 is a perspective view thereof with encircled portions 7, 8 being enlarged views in FIGS. 7 and 8, respectively;
 FIG. 7 is an enlarged view of the encircled portion 7 in FIG. 6;
 FIG. 8 is an enlarged view of the encircled portion 8 in FIG. 6; and,
 FIG. 9 is a perspective view showing the electronic display board in a different orientation.
 The rear surface of the electronic display board contains no ornamentality, and therefore, a rear view is not provided.

- (21) Appl. No.: **29/124,270**
- (22) Filed: **Jun. 5, 2000**
- (30) **Foreign Application Priority Data**
 Dec. 29, 1999 (JP) 11-36991
- (51) **LOC (7) Cl.** **20-02**
- (52) **U.S. Cl.** **D20/10**
- (58) **Field of Search** D20/10, 39, 40,
 D20/42; 40/568, 541, 549, 574, 578, 714,
 604, 605; D19/52

(56) **References Cited**

U.S. PATENT DOCUMENTS

- D. 405,473 * 2/1999 Jikhonski et al. D20/10
- D. 415,205 * 10/1999 Gongona et al. D20/10

1 Claim, 6 Drawing Sheets

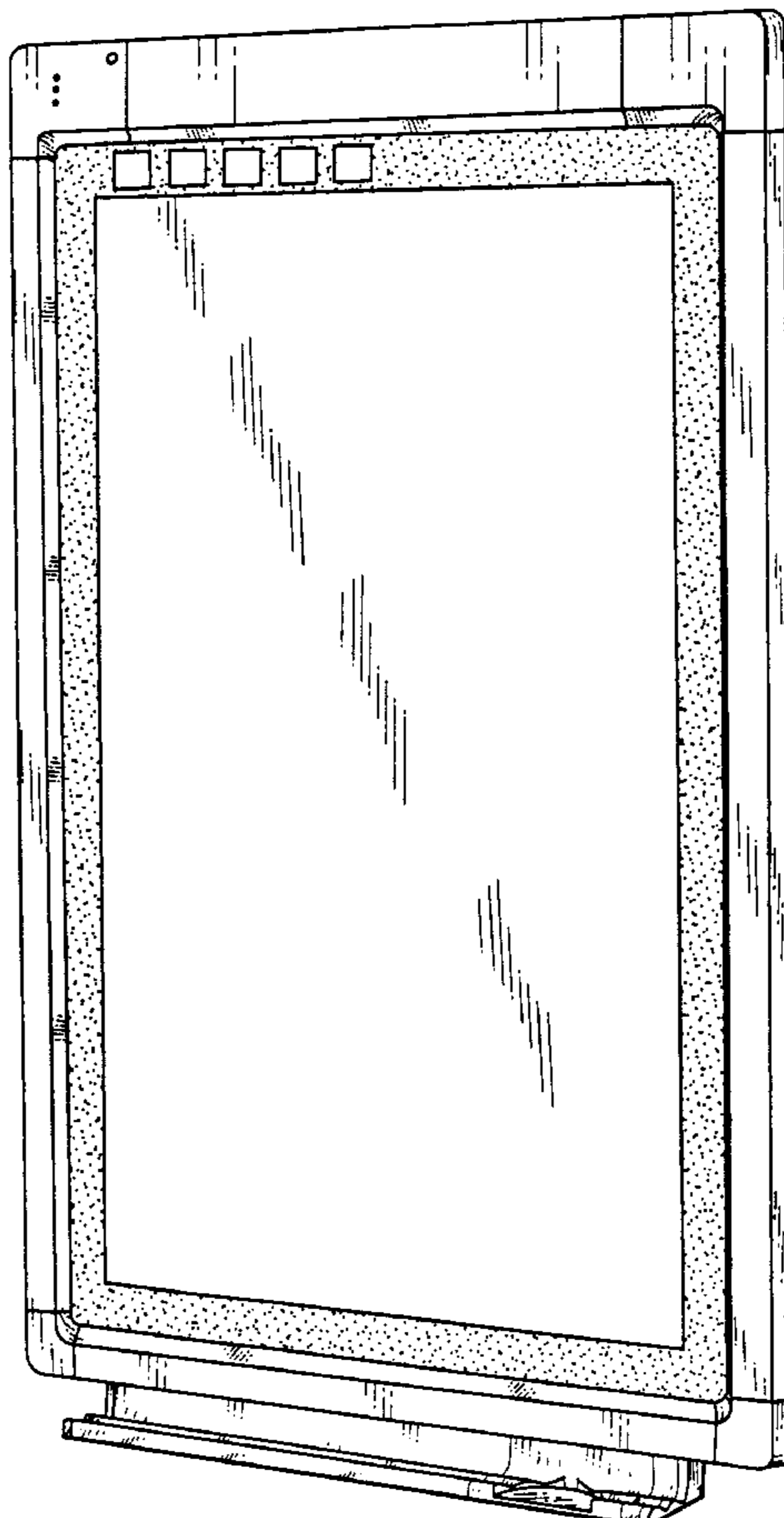

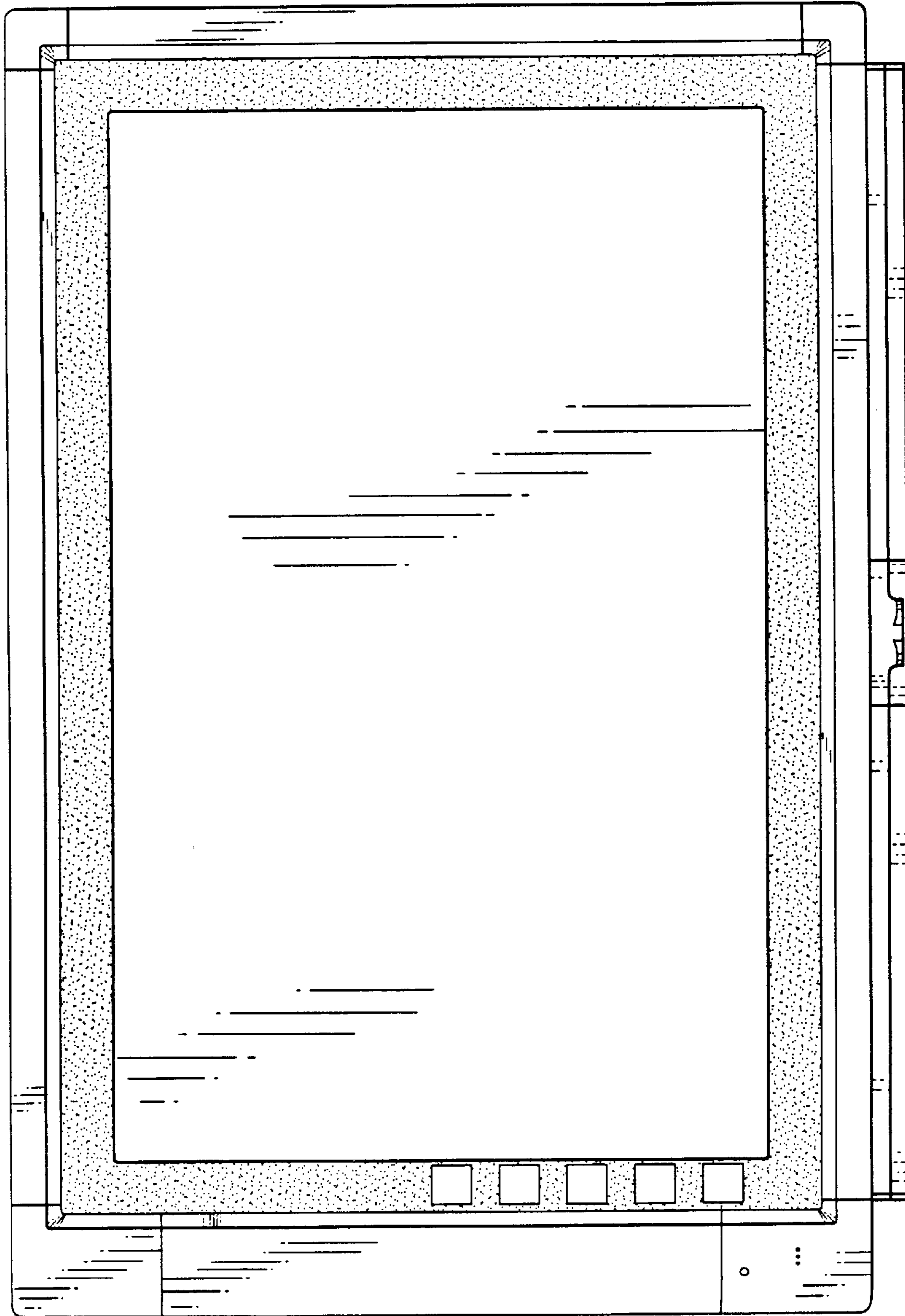

Fig. 1

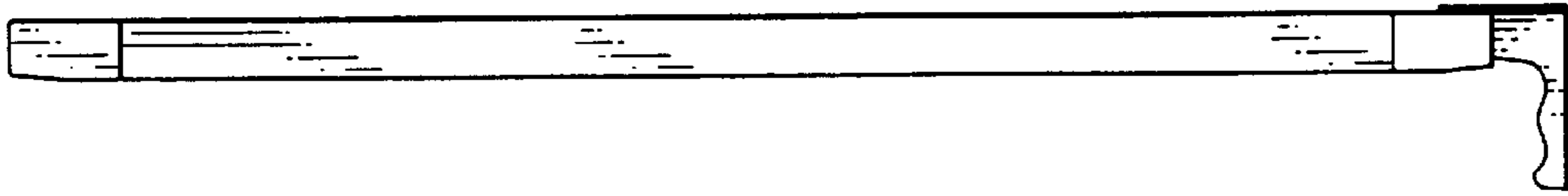

Fig. 3

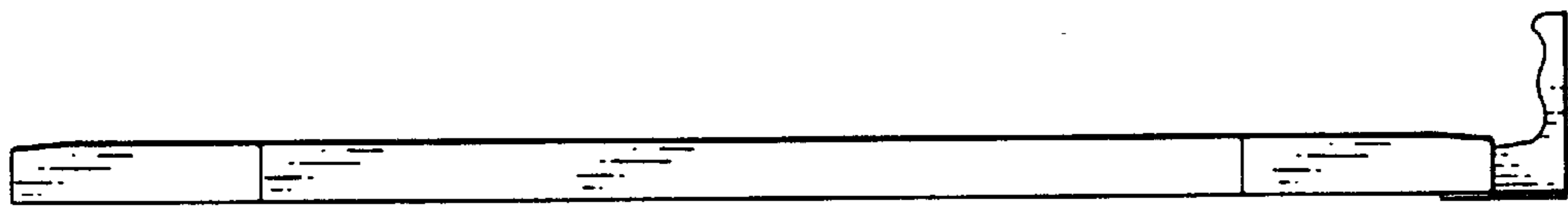

Fig. 2

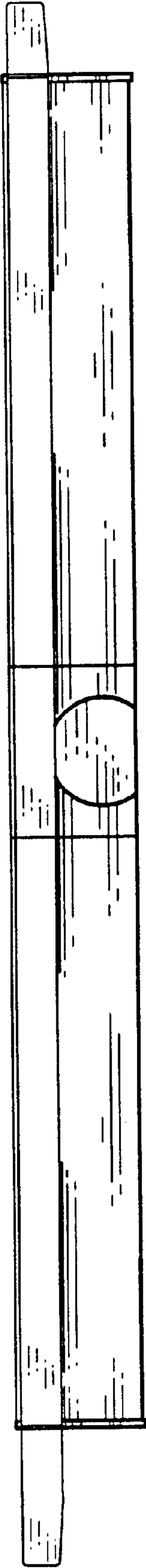

Fig. 4

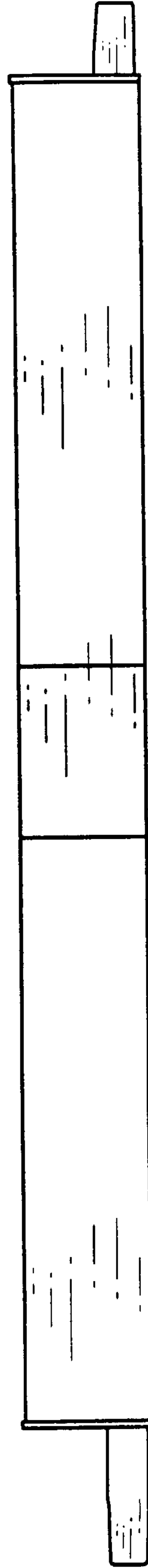

Fig. 5

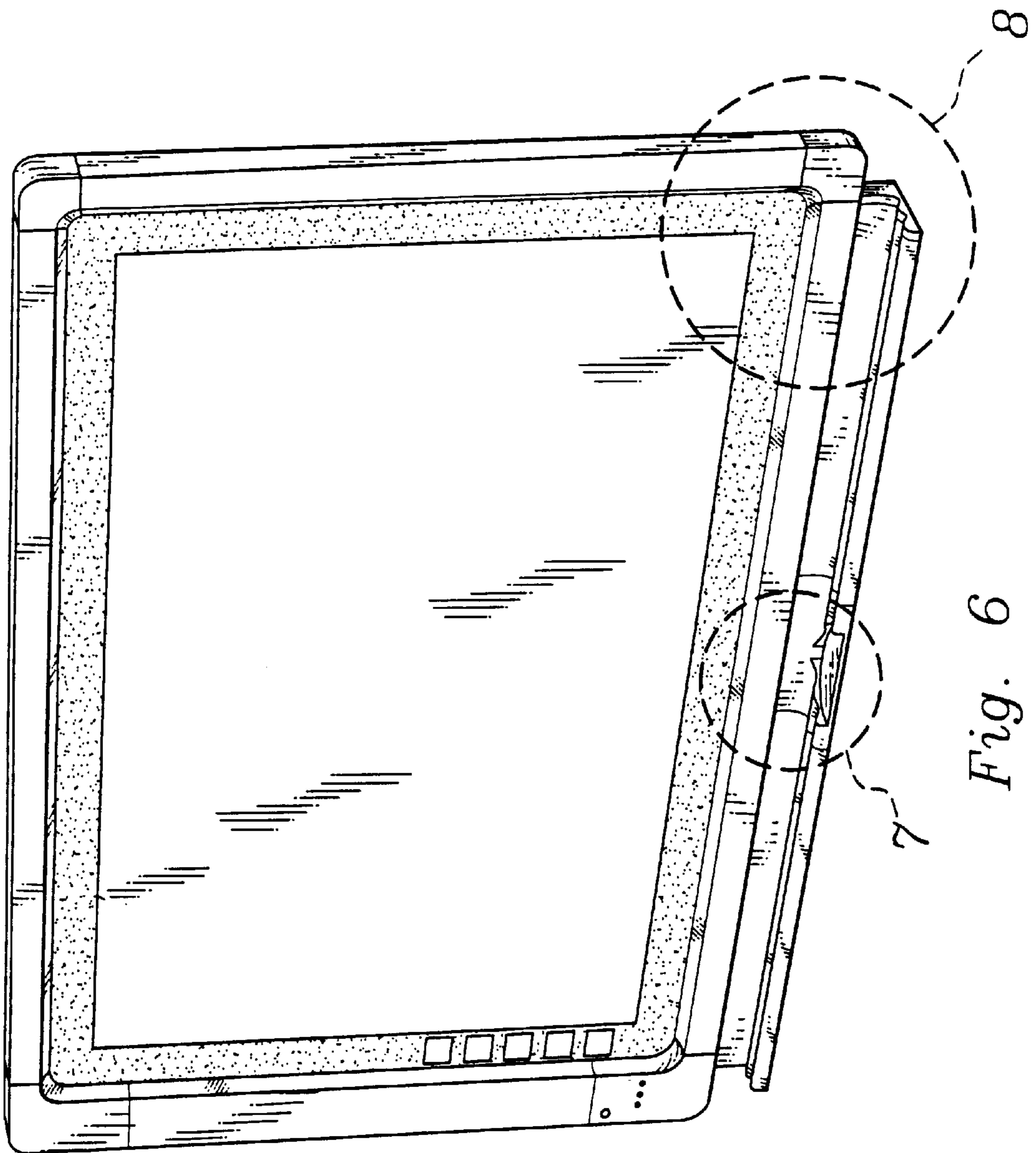

Fig. 6

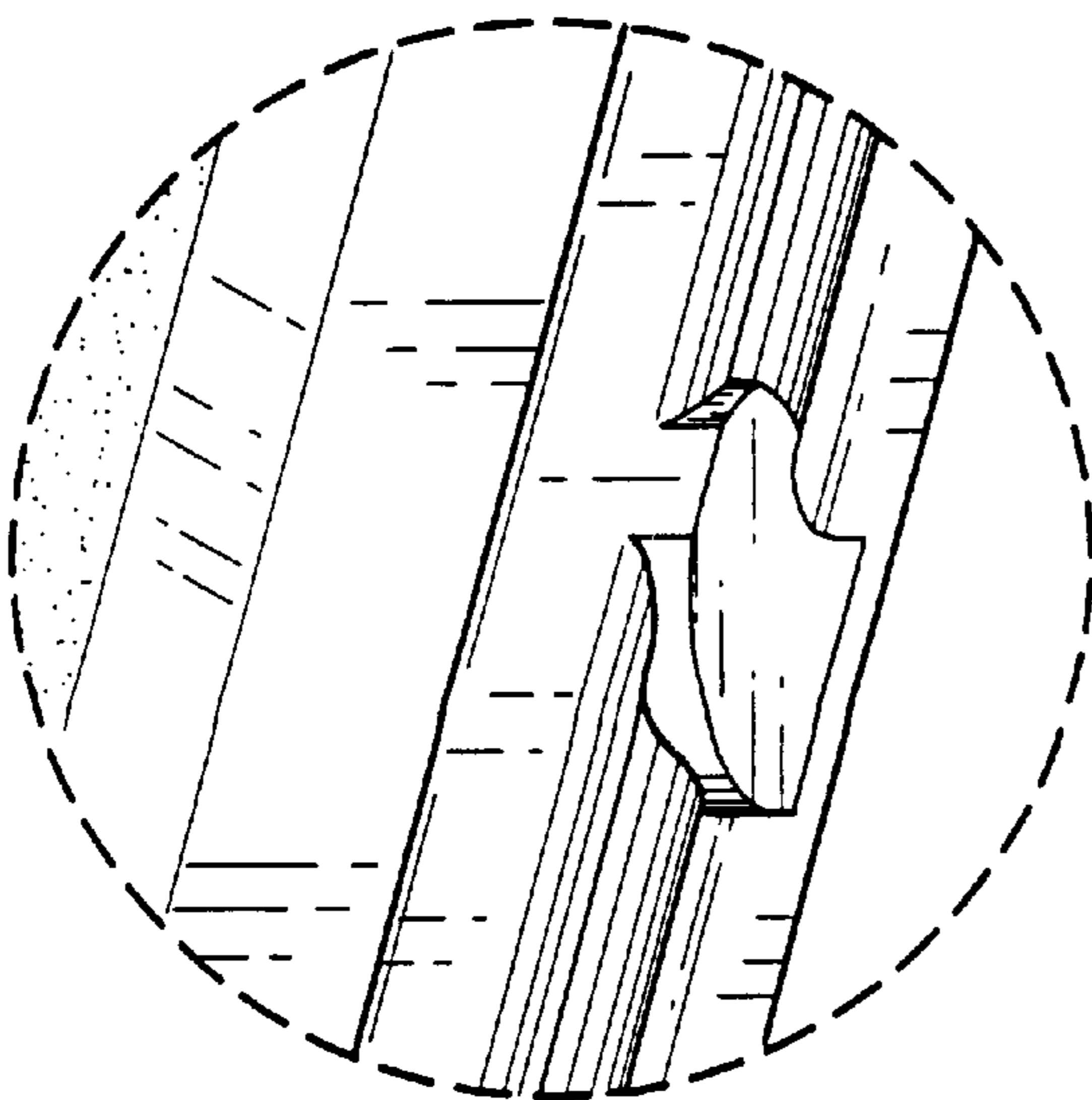

Fig. 7

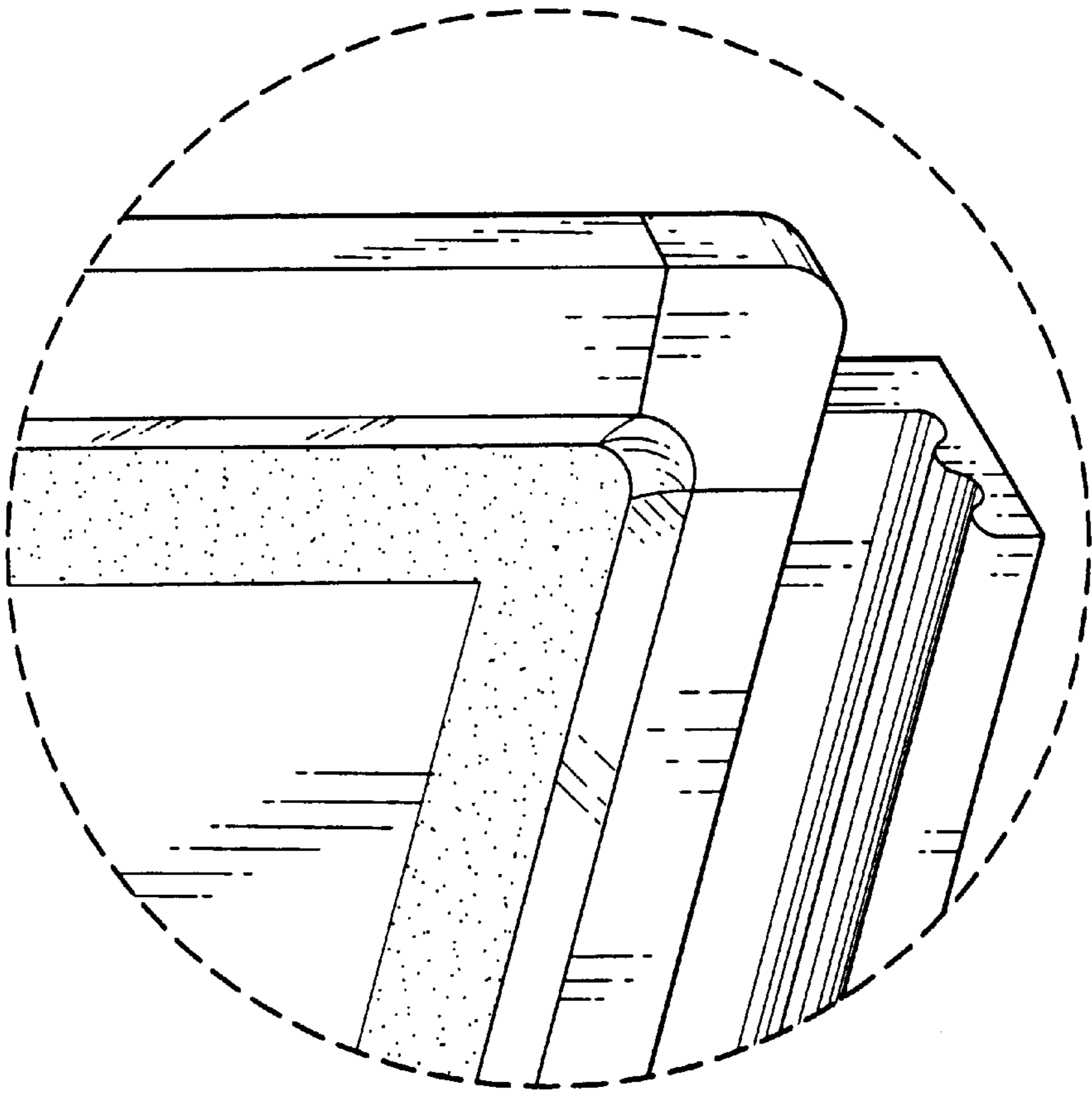

Fig. 8

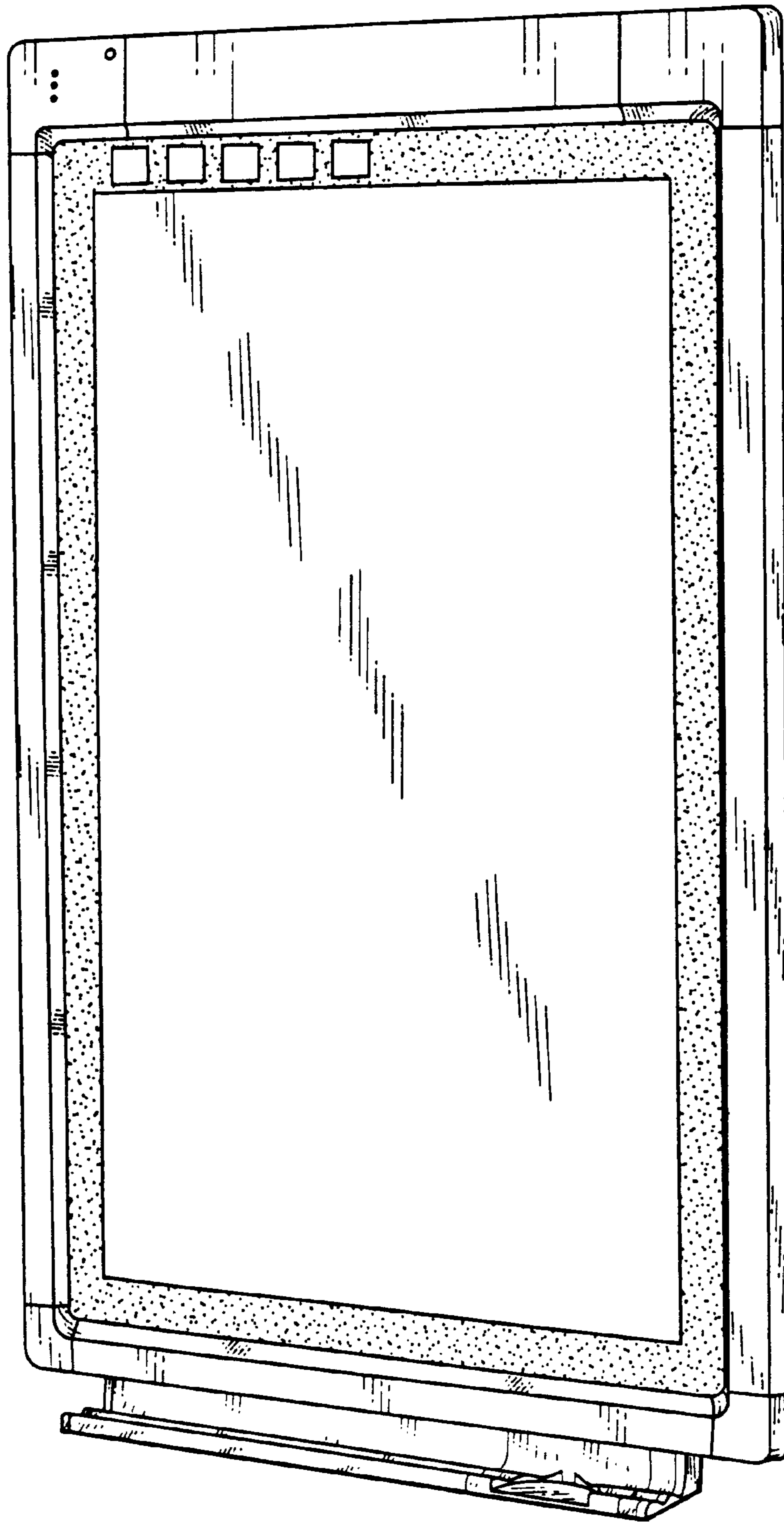

Fig. 9