



US00D438245S

(12) **United States Design Patent** (10) **Patent No.:** **US D438,245 S**  
**Hollington et al.** (45) **Date of Patent:** **\*\* Feb. 27, 2001**

(54) **WRITING INSTRUMENT**

(75) Inventors: **Geoffrey A. Hollington; David Townsend-Elliott**, both of London (GB)

(73) Assignee: **The Gillette Company**, Boston, MA (US)

(\*\*) Term: **14 Years**

(21) Appl. No.: **29/117,889**

(22) Filed: **Feb. 1, 2000**

(51) **LOC (7) Cl.** ..... **19-06**

(52) **U.S. Cl.** ..... **D19/50; D19/43; D19/51; D19/56; D19/57**

(58) **Field of Search** ..... D19/35, 36, 41-51, D19/53-58, 81-85; 401/99, 100, 101, 102, 103, 104, 110, 116, 209, 221, 222, 243-247, 202, 262

(56) **References Cited**

**U.S. PATENT DOCUMENTS**

- D. 81,254 5/1930 Parker .
- D. 84,249 5/1931 Larsen .

(List continued on next page.)

**OTHER PUBLICATIONS**

Sheaffer Brochure, Targa by Sheaffer 1001, Targa by Sheaffer 1005, Targa by Sheaffer 1006 date unknown.

(List continued on next page.)

*Primary Examiner*—Martie K. Holtje

(74) *Attorney, Agent, or Firm*—Chester Cekala; David A. Howley

(57) **CLAIM**

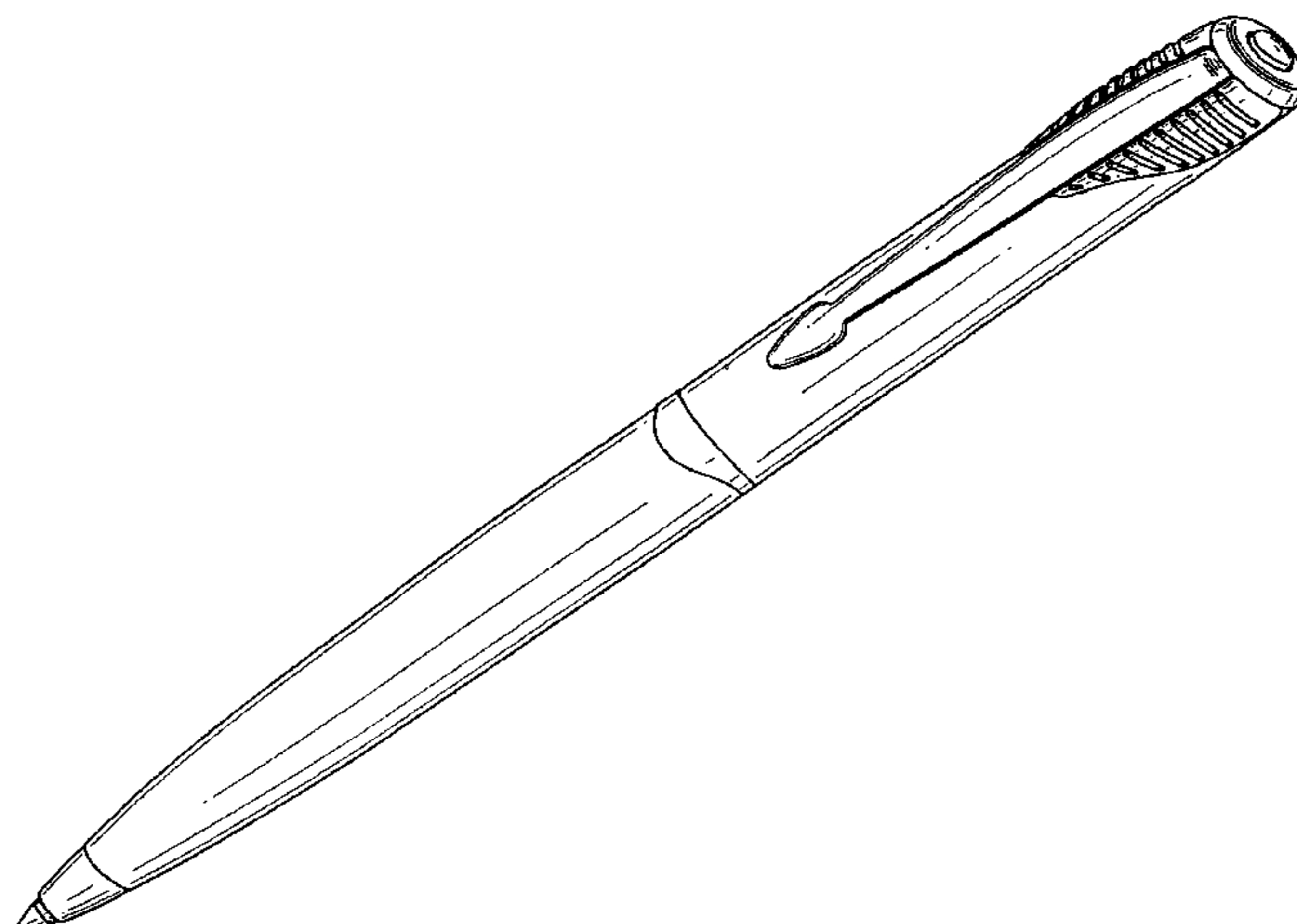
The ornamental design for a writing instrument, as shown and described.

**DESCRIPTION**

FIG. 1 is a perspective view as seen from the top, front and right side of a first embodiment of a writing instrument showing our new design;

FIG. 2 is a top plan view thereof;  
 FIG. 3 is a left side elevational view thereof, the right side elevation being a mirror image thereof;  
 FIG. 4 is a bottom plan view thereof;  
 FIG. 5 is a front elevational view thereof;  
 FIG. 6 is a rear elevational view thereof;  
 FIG. 7 is a perspective view as seen from the top, front and right side of a second embodiment of a writing instrument showing our new design;  
 FIG. 8 is a top plan view thereof;  
 FIG. 9 is a left side elevational view thereof, the right side elevation being a mirror image thereof;  
 FIG. 10 is a bottom plan view thereof;  
 FIG. 11 is a front elevational view thereof;  
 FIG. 12 is a rear elevational view thereof;  
 FIG. 13 is a perspective view as seen from the top, front and right side of a third embodiment of a writing instrument showing our new design;  
 FIG. 14 is a top plan view thereof;  
 FIG. 15 is a left side elevational view thereof, the right side elevation being a mirror image thereof;  
 FIG. 16 is a bottom plan view thereof;  
 FIG. 17 is a front elevational view thereof;  
 FIG. 18 is a rear elevational view thereof;  
 FIG. 19 is a perspective view as seen from the top, front and right side of a fourth embodiment of a writing instrument showing our new design;  
 FIG. 20 is a top plan view thereof;  
 FIG. 21 is a left side elevational view thereof, the right side elevation being a mirror image thereof;  
 FIG. 22 is a bottom plan view thereof;  
 FIG. 23 is a front elevational view thereof;  
 FIG. 24 is a rear elevational view thereof;  
 FIG. 25 is a perspective view as seen from the top, front and right side of the writing instrument of FIG. 13 or 19 with a cap over the writing end of the writing instrument showing our new design;  
 FIG. 26 is a top plan view thereof;  
 FIG. 27 is a left side elevational view thereof, the right side elevation being a mirror image thereof;  
 FIG. 28 is a bottom plan view thereof;  
 FIG. 29 is a front elevational view thereof; and,  
 FIG. 30 is a rear elevational view thereof.

**1 Claim, 15 Drawing Sheets**

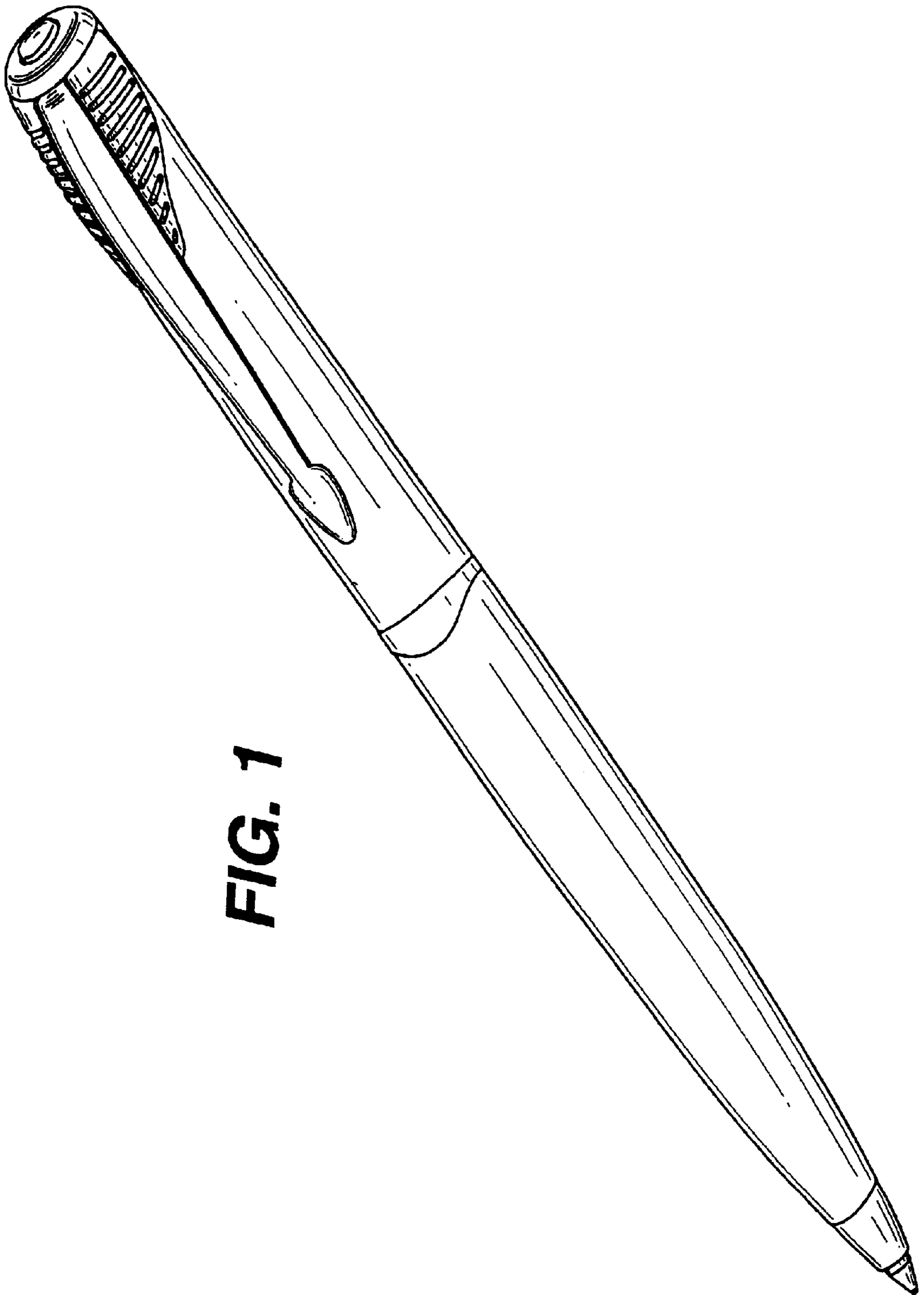


U.S. PATENT DOCUMENTS

D. 88,821	*	12/1932	Platt et al.	.....	D19/42
D. 93,444	*	10/1934	Blakeman	.....	D19/56
D. 98,522		2/1936	Juelss .		
D. 212,788	*	11/1968	Perwas	.....	D19/56
D. 279,383	*	6/1985	Hillebrand et al.	.....	D19/51
D. 312,477		11/1990	Porsche	.....	D19/43
D. 316,427		4/1991	Tinz	.....	D19/48
D. 323,189		1/1992	Tu	.....	D19/48
D. 323,673		2/1992	Gomez	.....	D19/49
D. 324,067		2/1992	Katami	.....	D19/48
D. 324,072		2/1992	Von Edler et al.	.....	D19/51
D. 327,707		7/1992	Datami	.....	D19/49
D. 330,217	*	10/1992	Booker	.....	D19/48
D. 338,491	*	8/1993	Hollington	.....	D19/50
D. 342,546		12/1993	Song	.....	D19/50
D. 355,439		2/1995	Hollington	.....	D19/43
D. 362,269	*	9/1995	Hollington	.....	D19/51
D. 378,763	*	4/1997	Hollington	.....	D19/51
D. 381,043		7/1997	Hasegawa	.....	D19/51
D. 391,606		3/1998	Compte	.....	D19/51
D. 398,934		9/1998	Veillon	.....	D19/51
D. 404,426		1/1999	Takanashi	.....	D19/43
D. 407,436		3/1999	Chevalier et al.	.....	D19/43
D. 415,198		10/1999	Mouawad	.....	D19/48
D. 416,577		11/1999	Andrews et al.	.....	D19/50
D. 416,580	*	11/1999	Andrews et al.	.....	D19/56

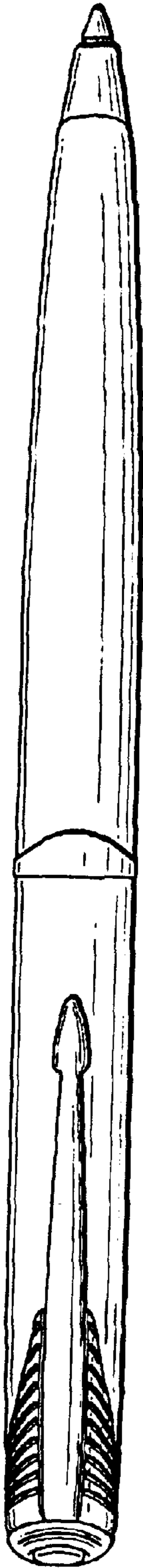
OTHER PUBLICATIONS

Parker Brochure, The Famous Parker "51" date unknown.  
 Parker, T-Ball Jotter Ballpoints, No. J-2, No. J-1, No. MP-1, No. P-1, Parker Circular #9508, Feb., 1960.  
 The Parker 75 Brochure date unknown.  
 Parker, Parker T-Ball Ballpoint, Parker Circular #9086-RI, Sep., 1961.  
 \* cited by examiner

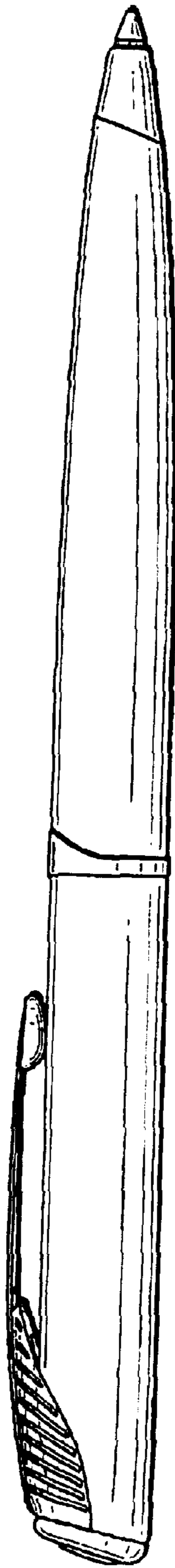


**FIG. 1**

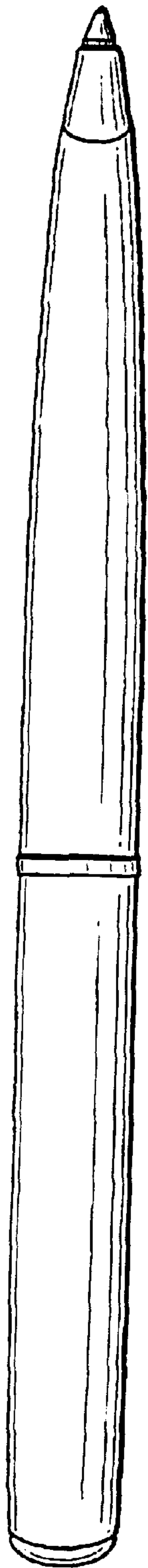
**FIG. 2**



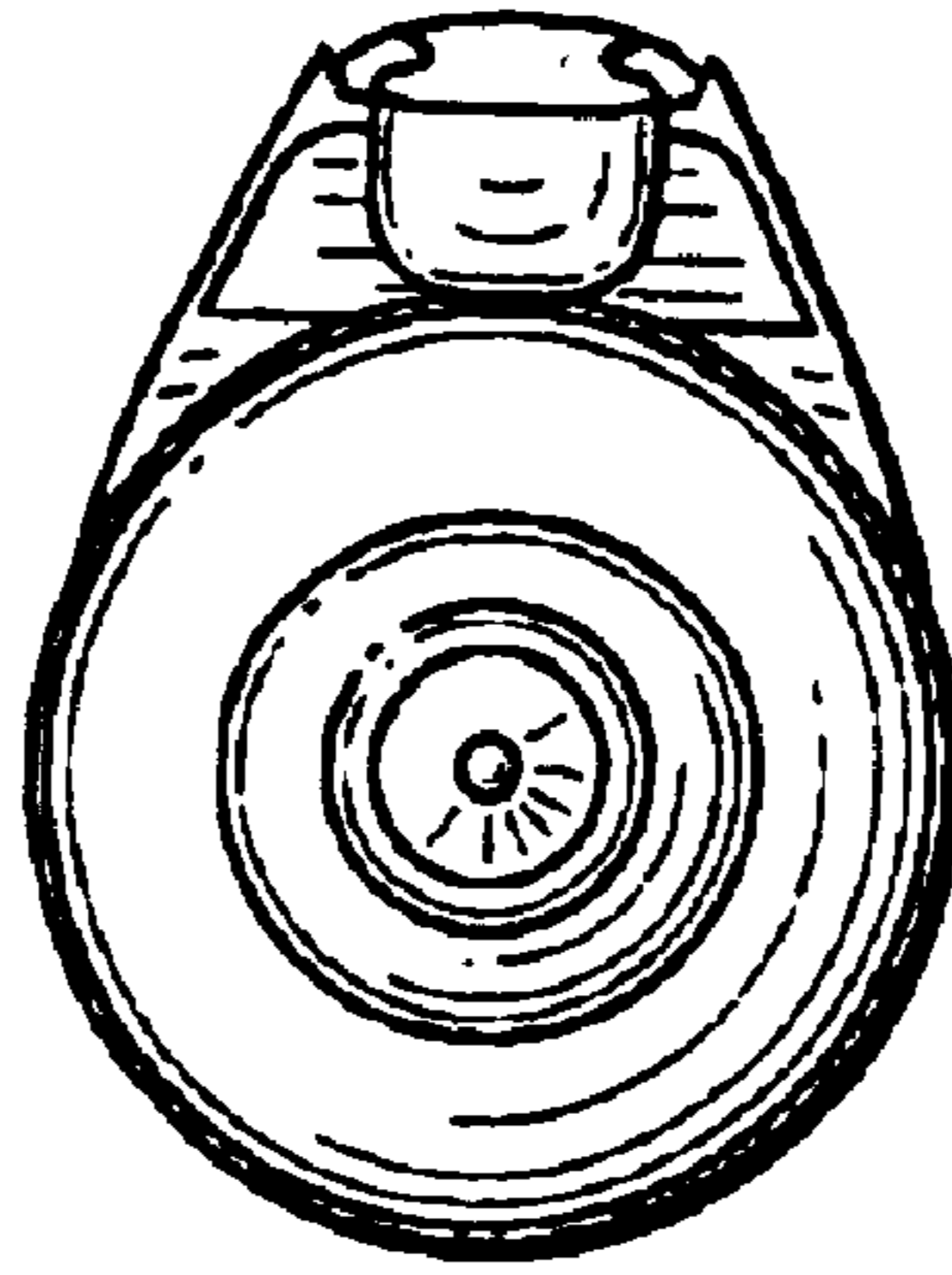
**FIG. 3**



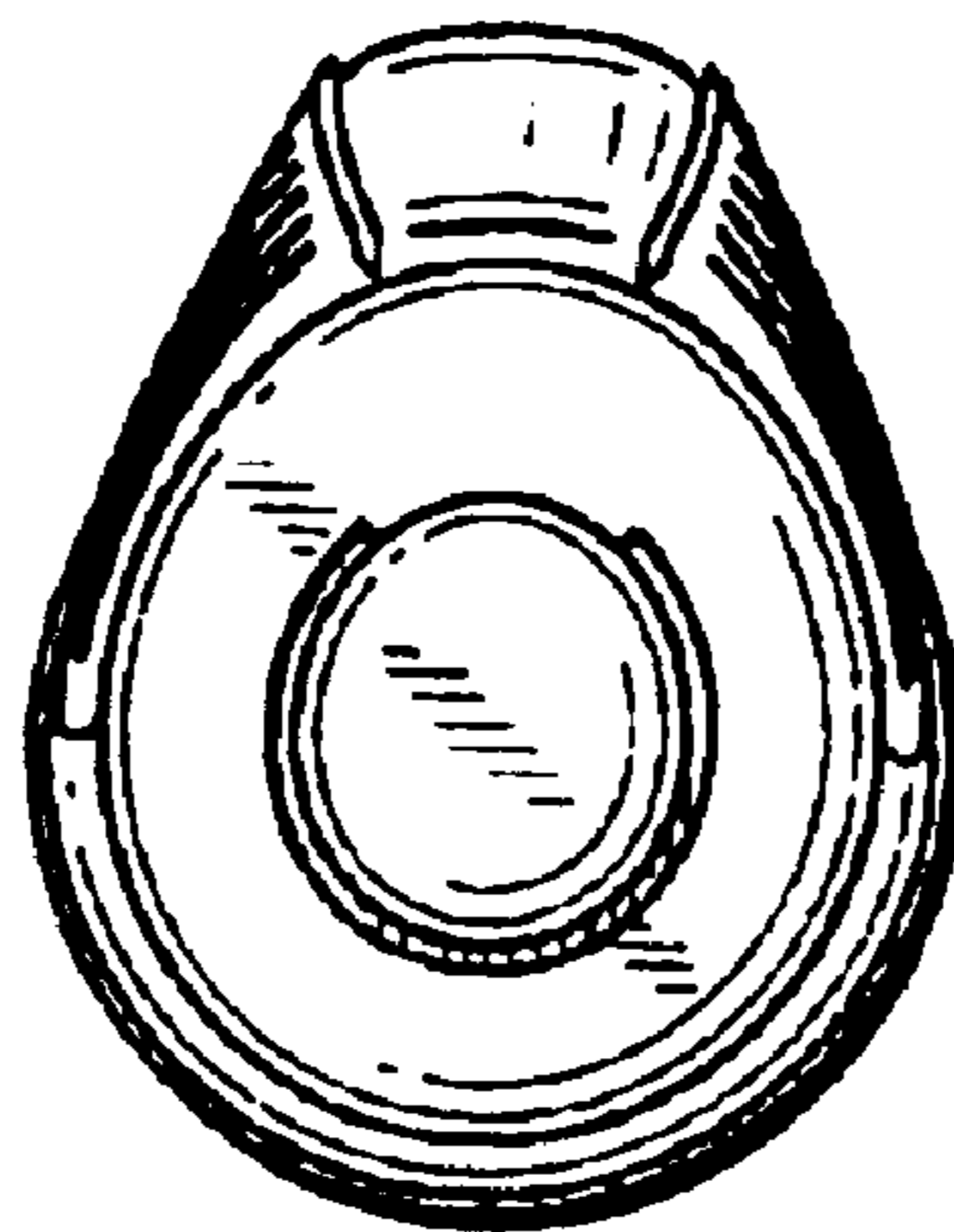
**FIG. 4**

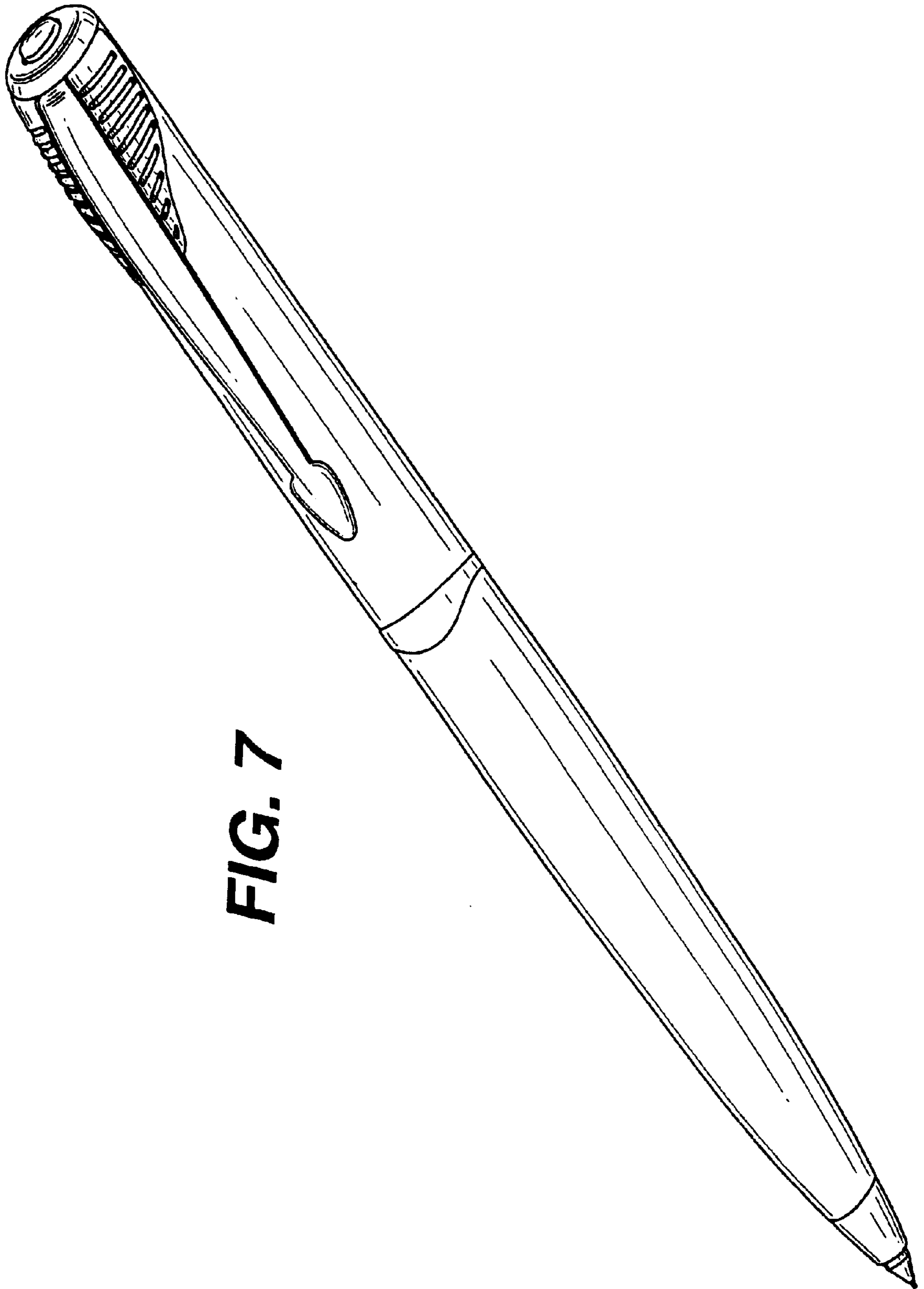


**FIG. 5**



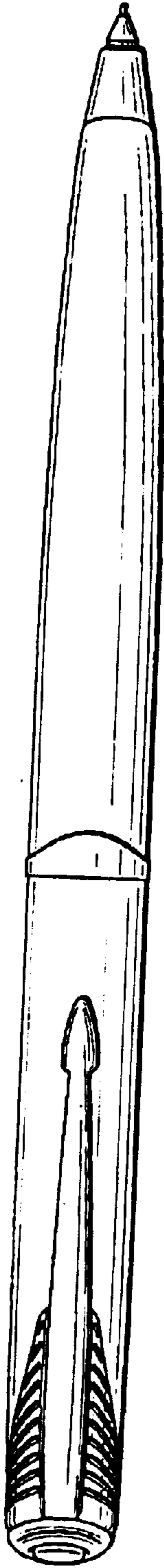
**FIG. 6**



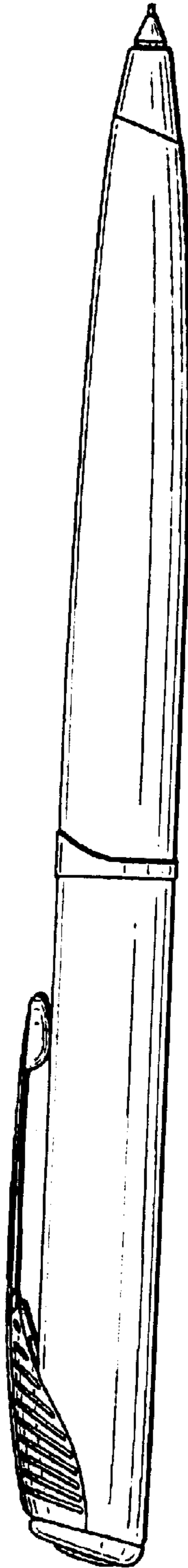


**FIG. 7**

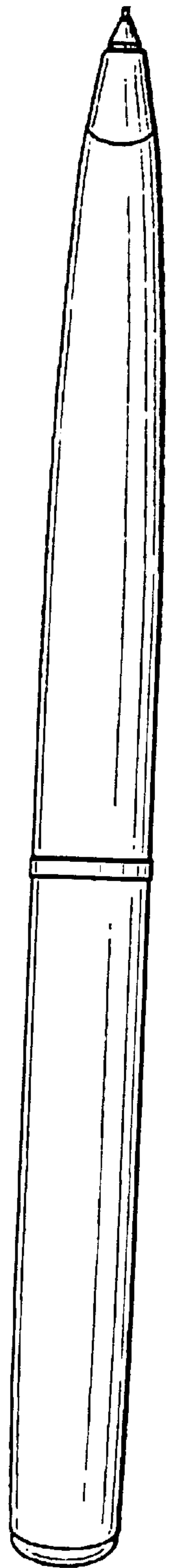
**FIG. 8**



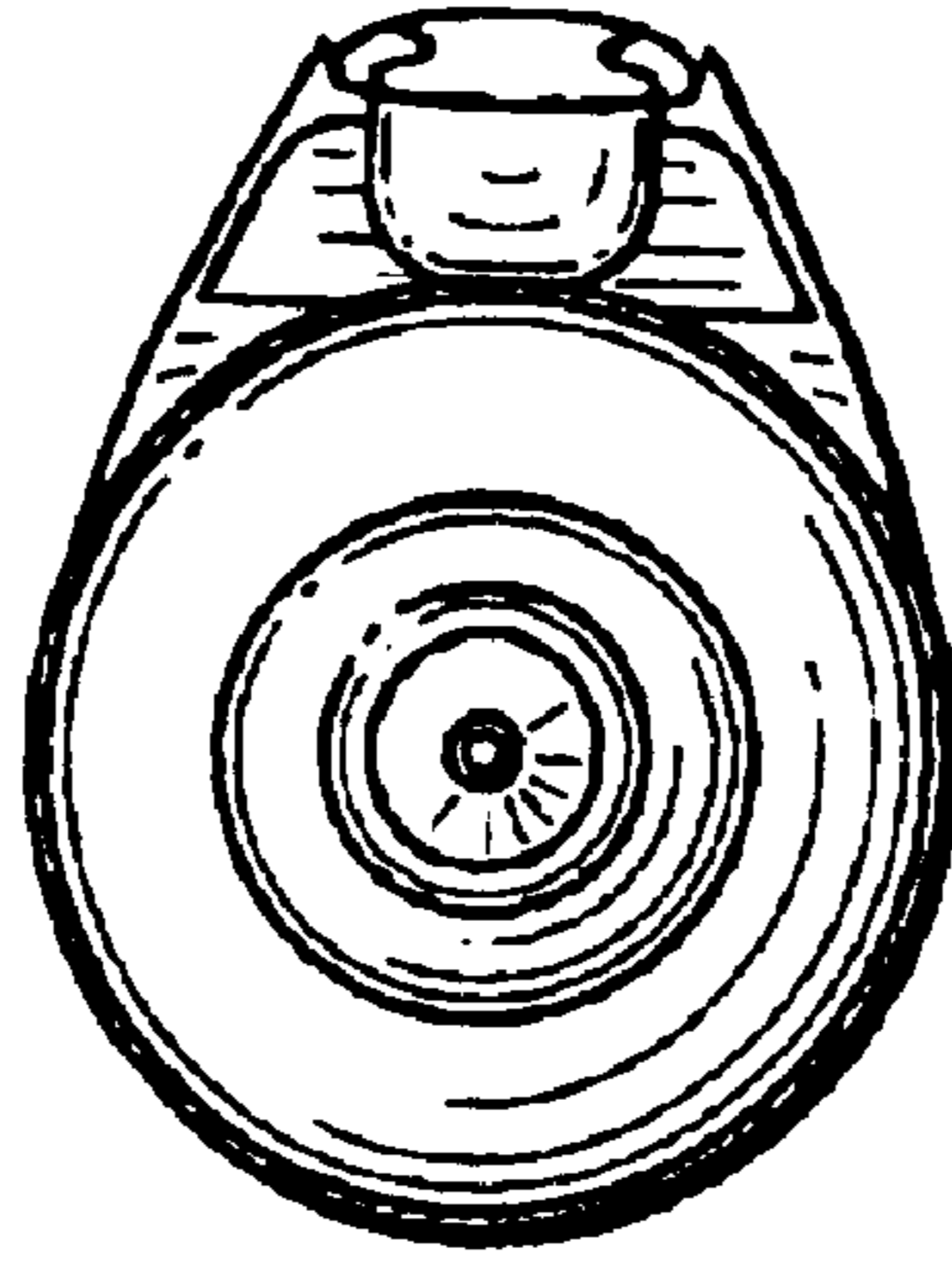
**FIG. 9**



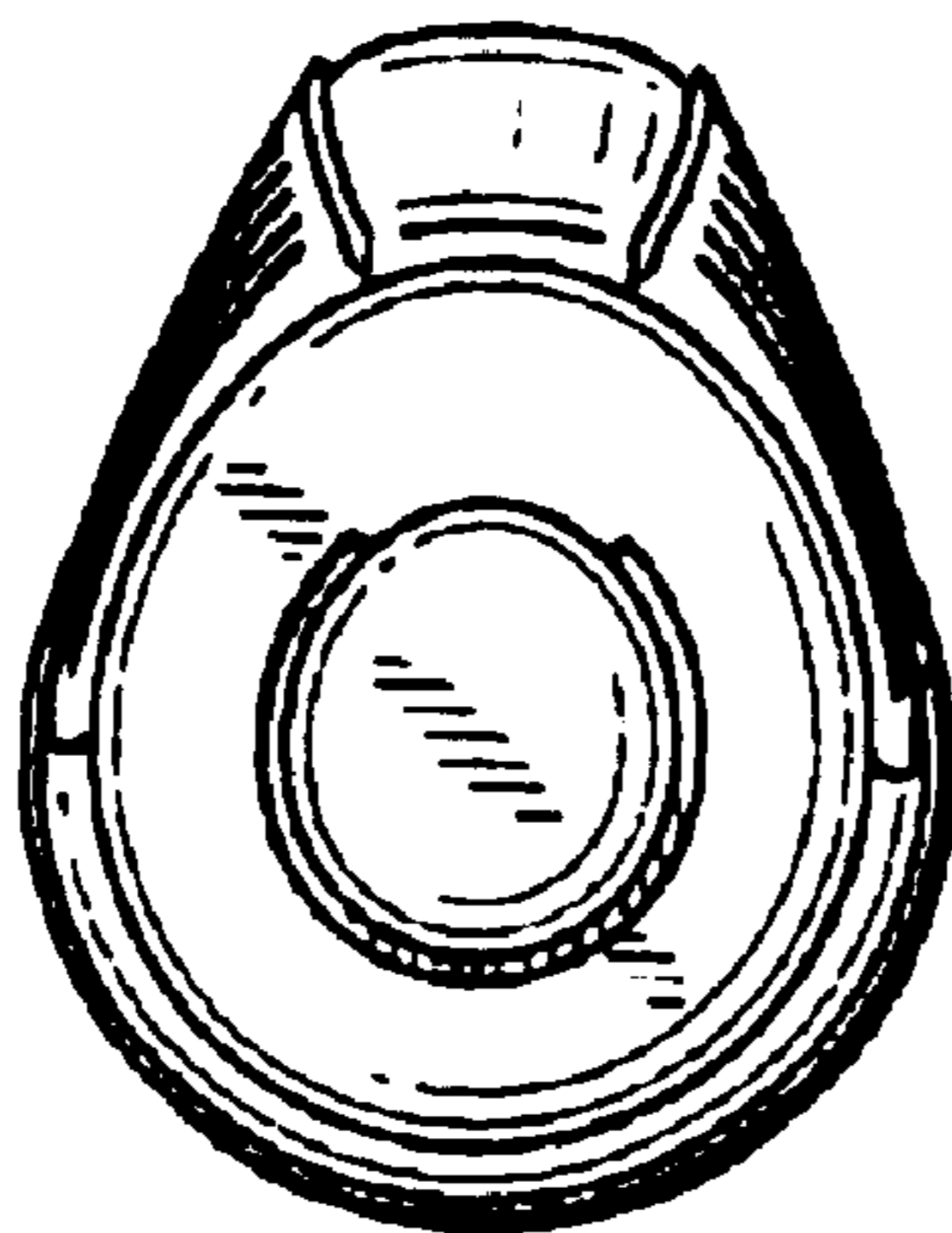
**FIG. 10**



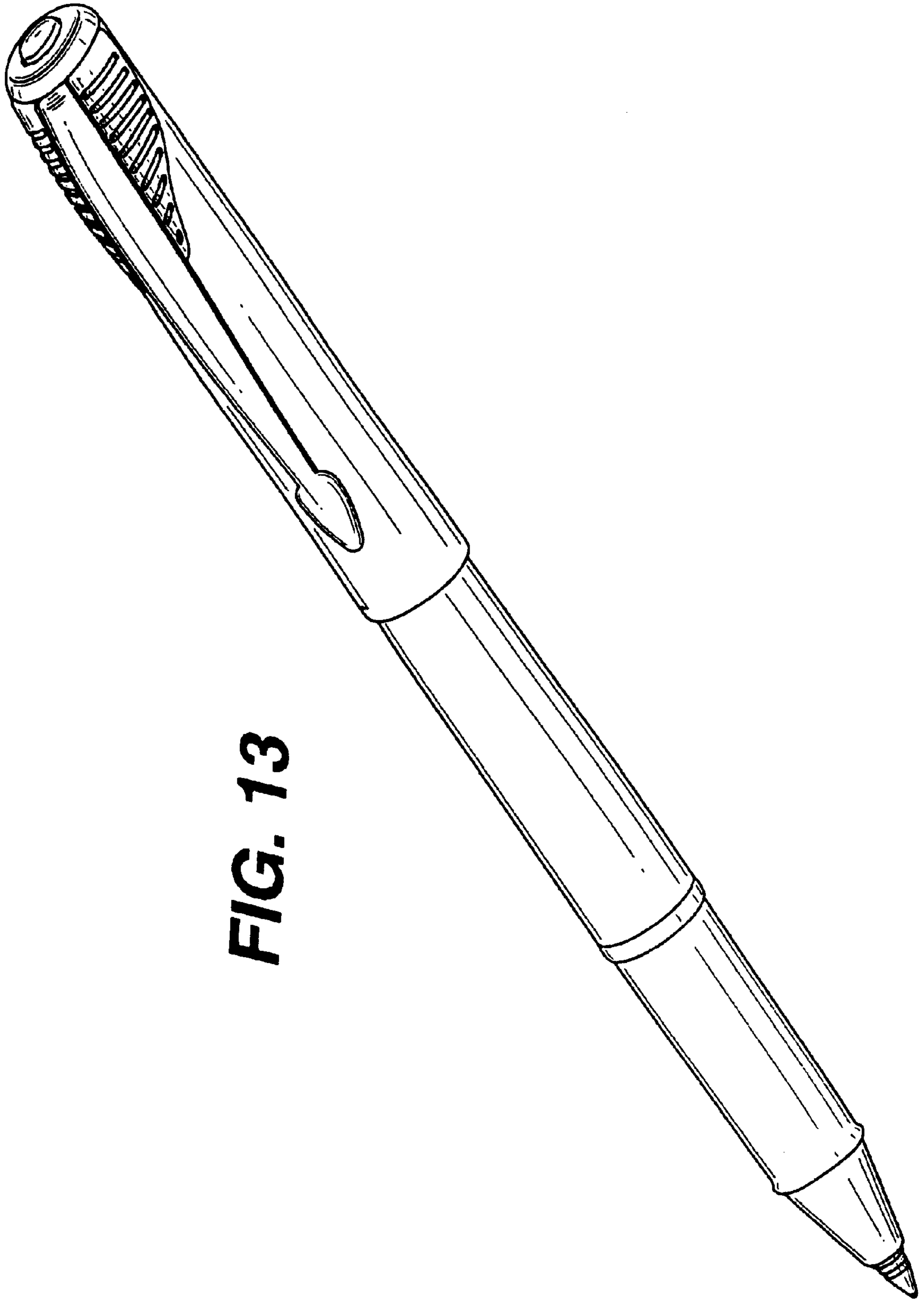
***FIG. 11***



***FIG. 12***

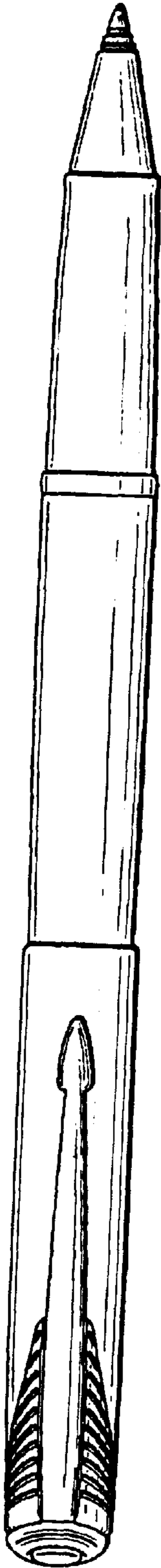




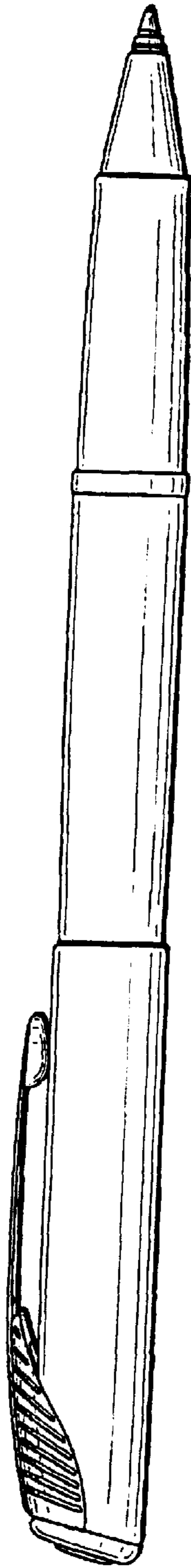


**FIG. 13**

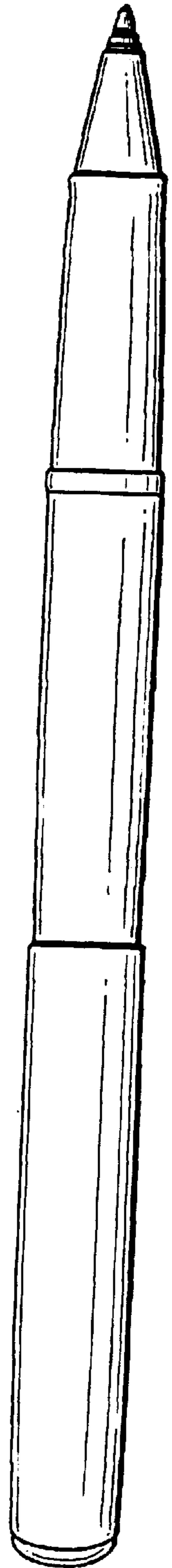
**FIG. 14**



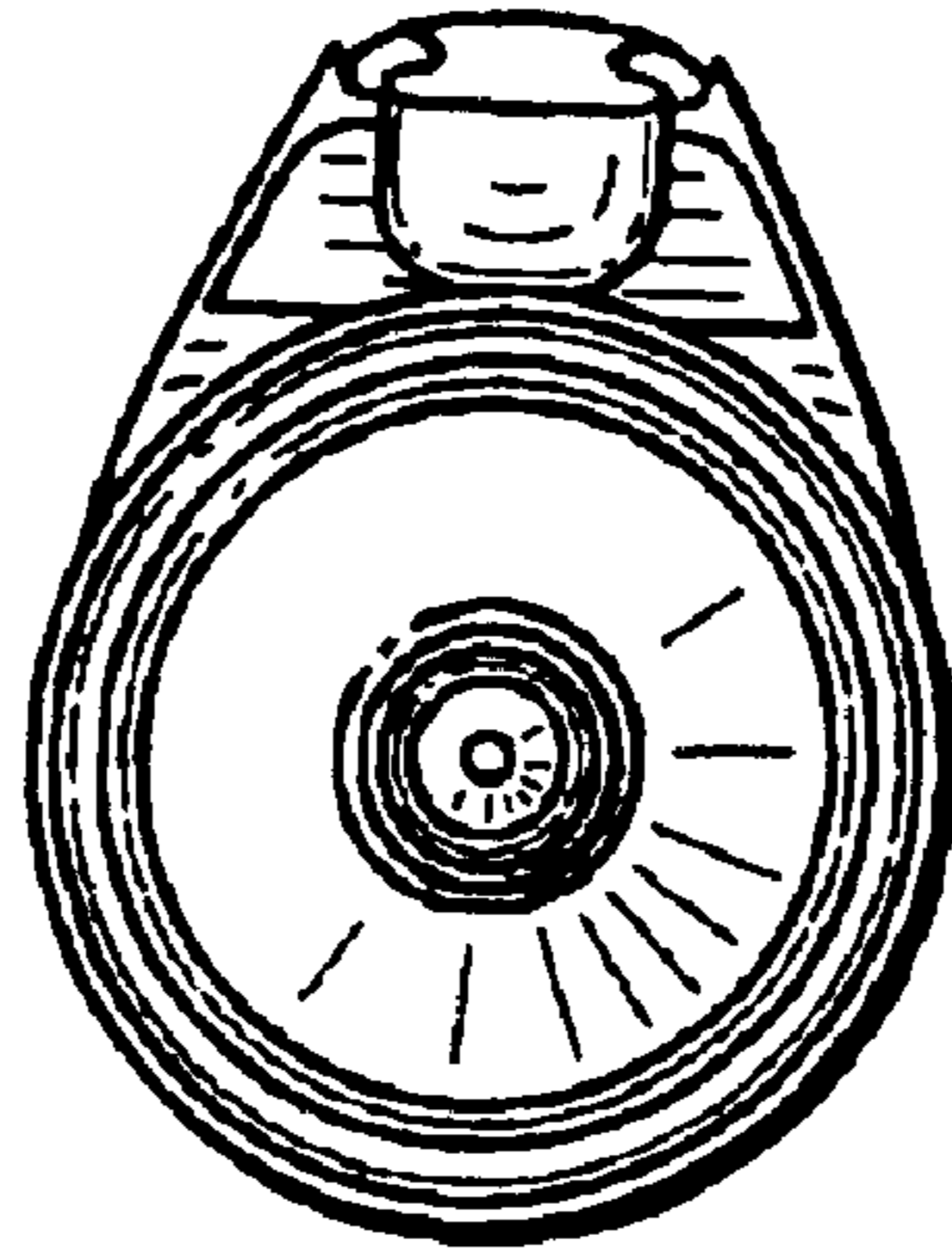
**FIG. 15**



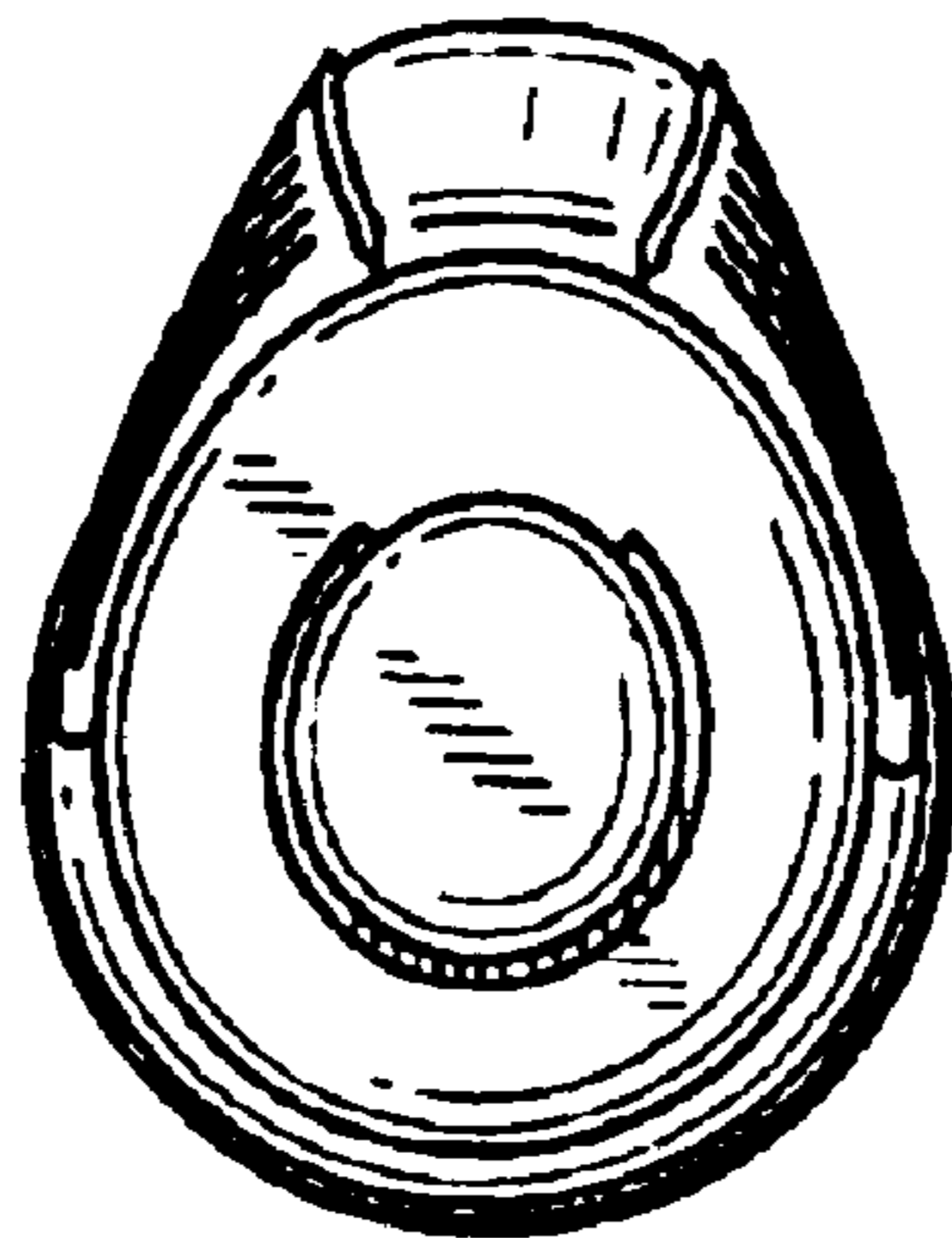
**FIG. 16**

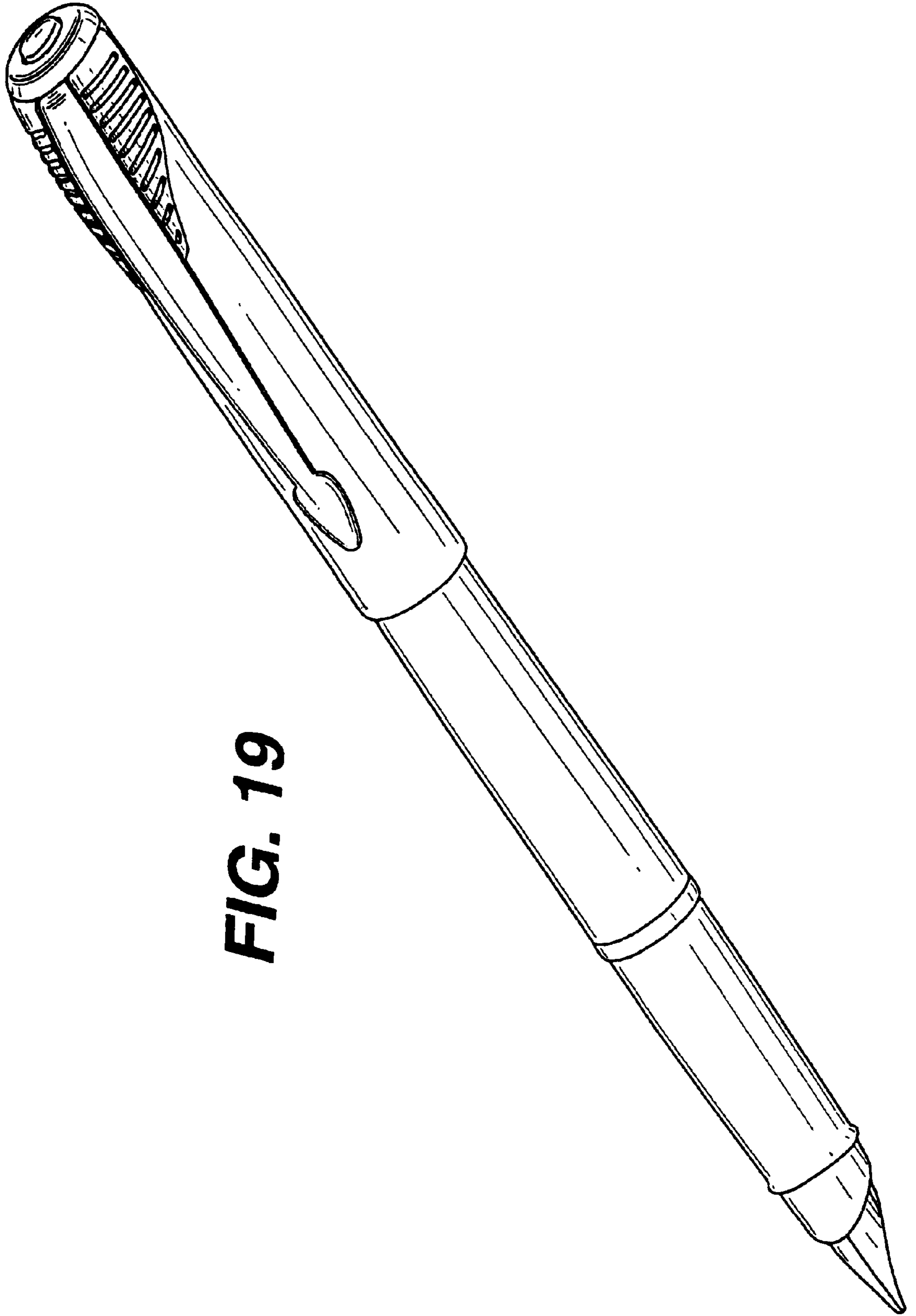


***FIG. 17***



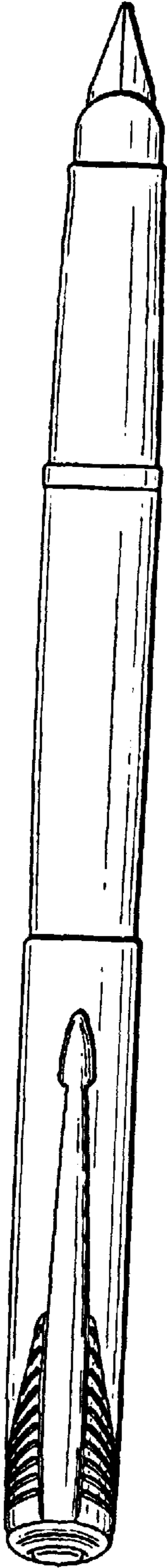
***FIG. 18***



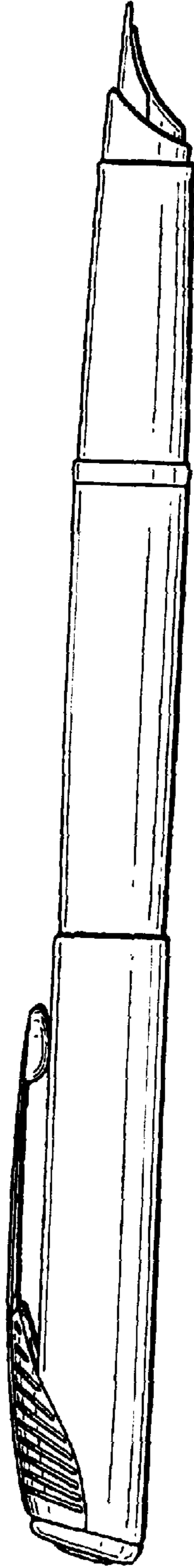


**FIG. 19**

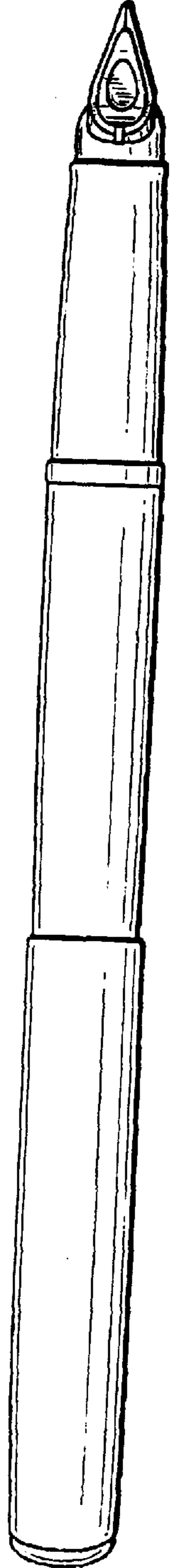
**FIG. 20**



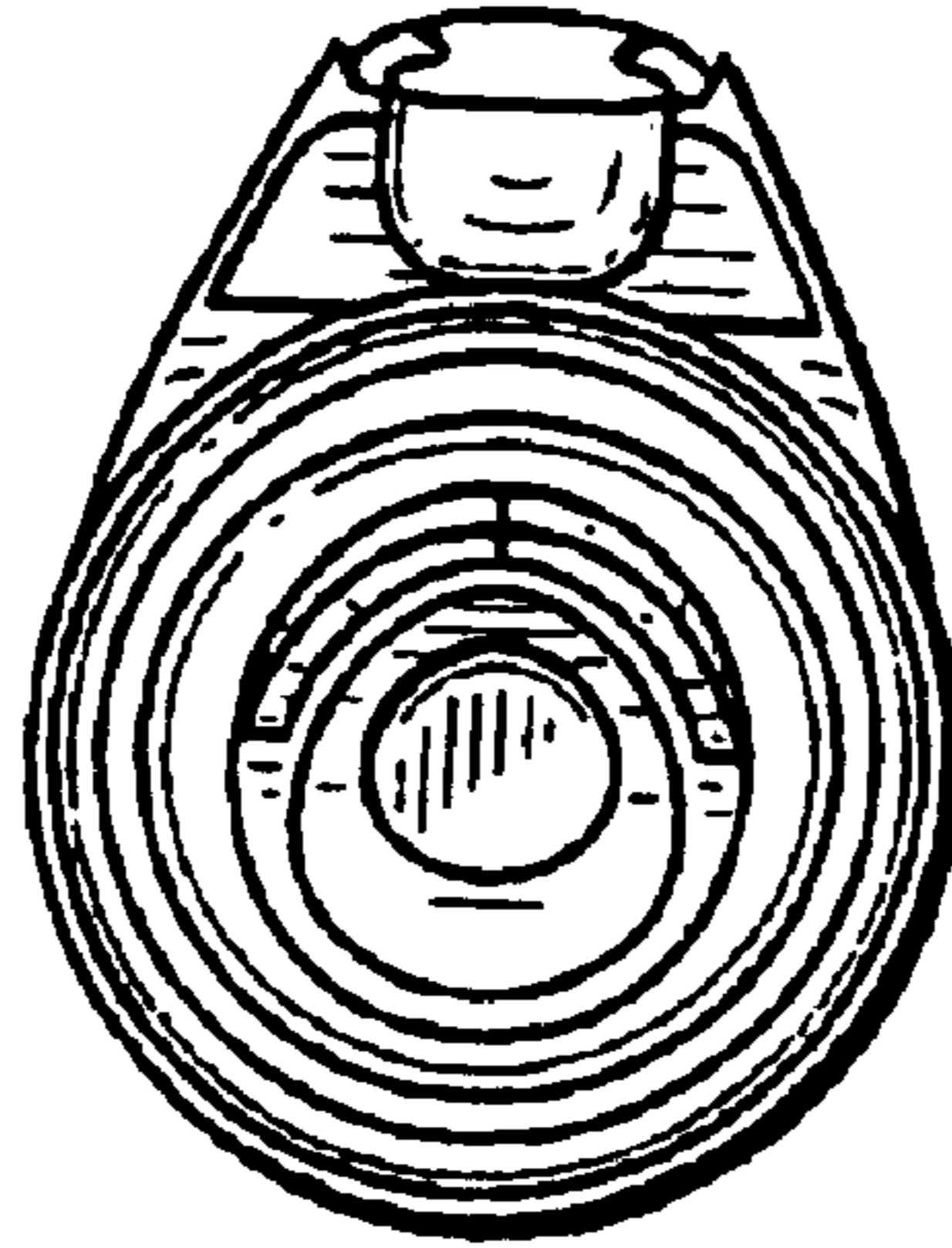
**FIG. 21**



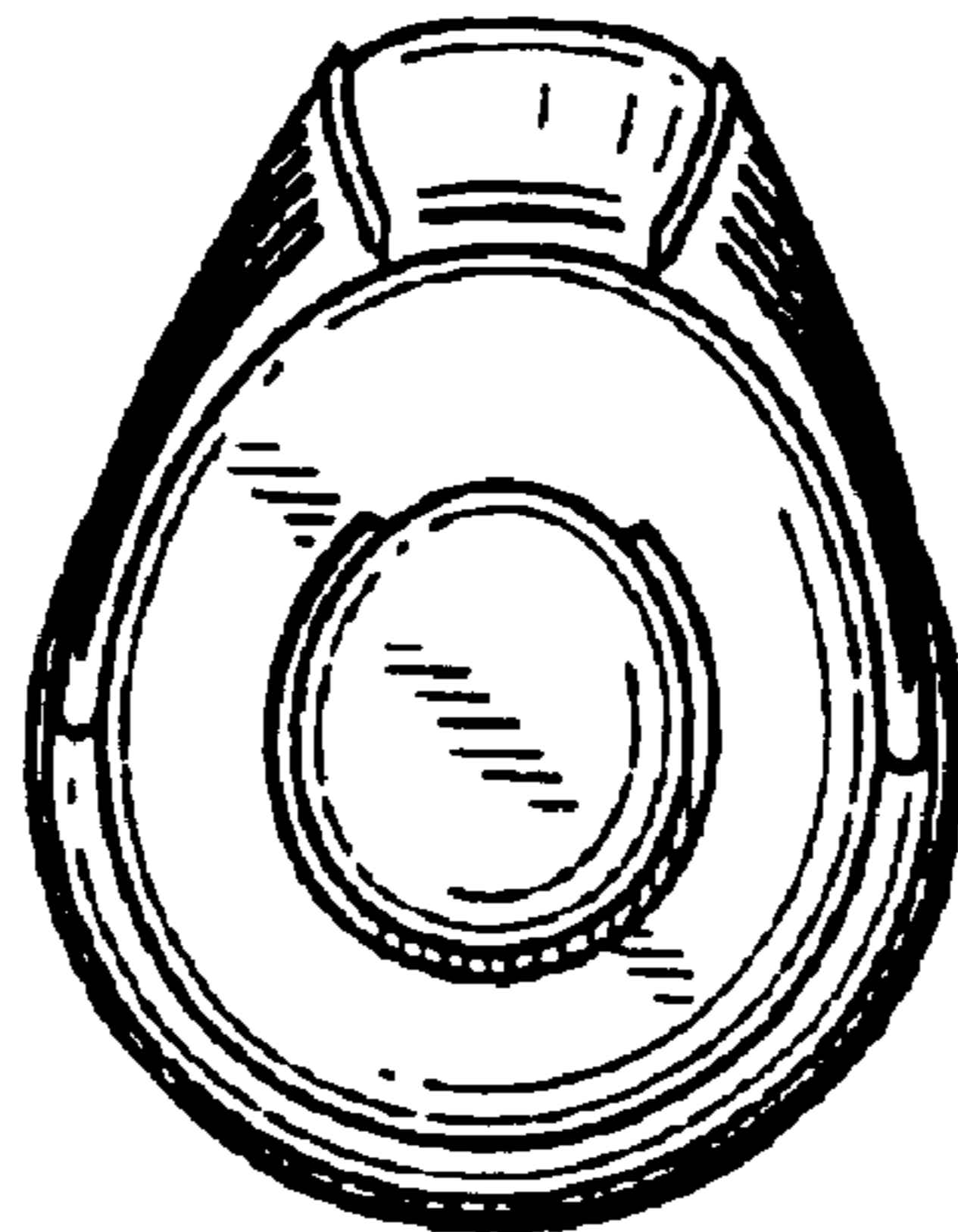
**FIG. 22**

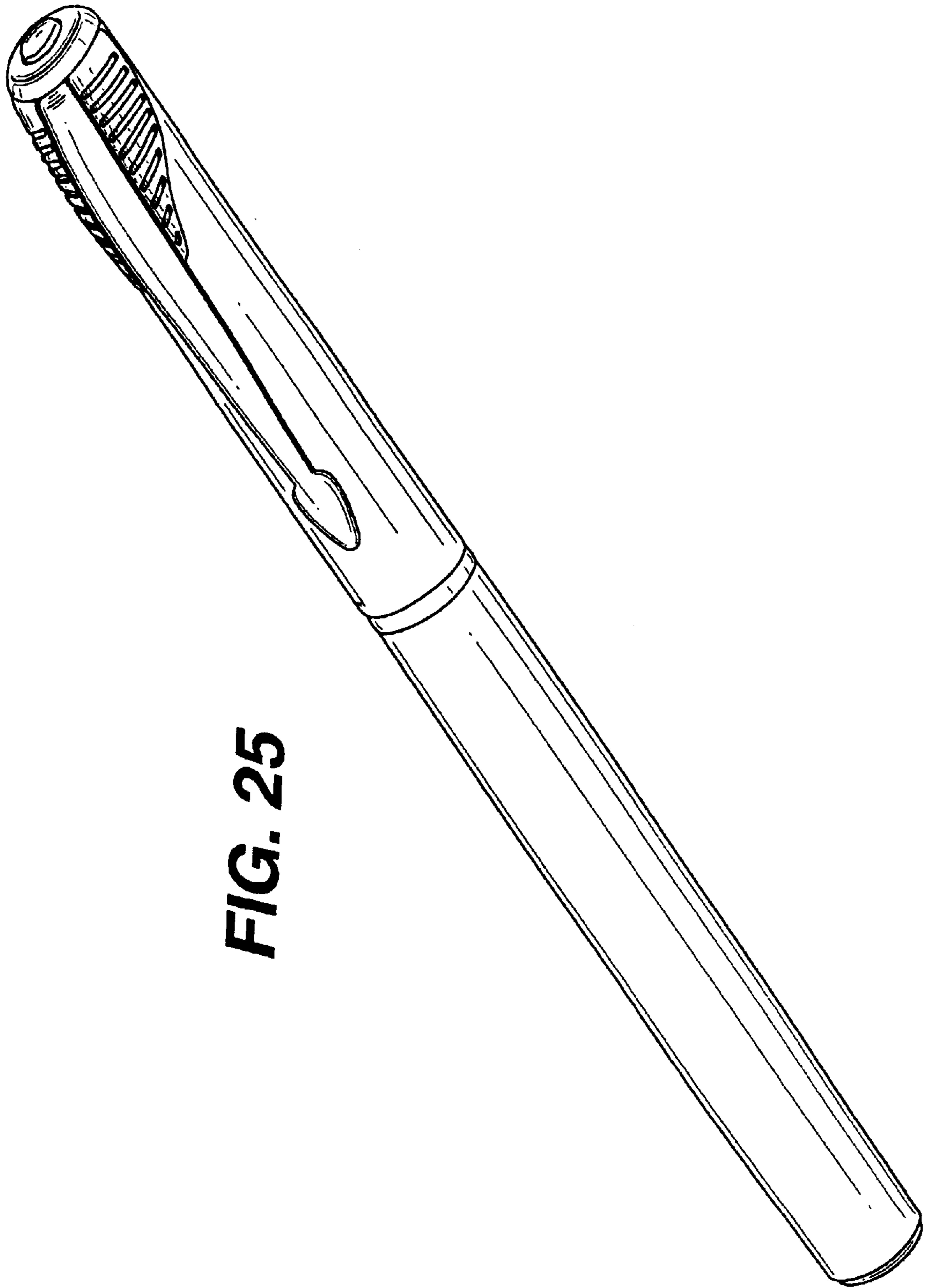


**FIG. 23**



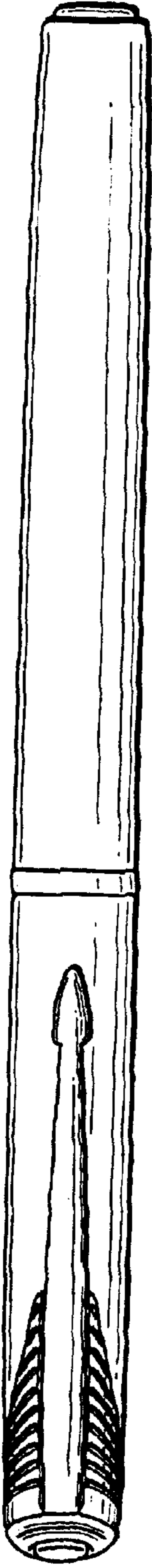
**FIG. 24**



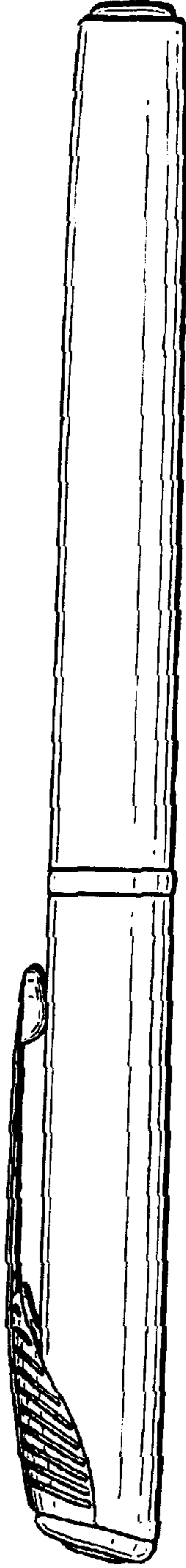


**FIG. 25**

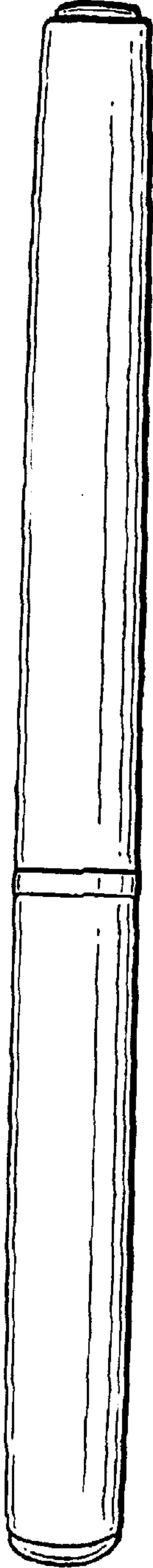
**FIG. 26**



**FIG. 27**

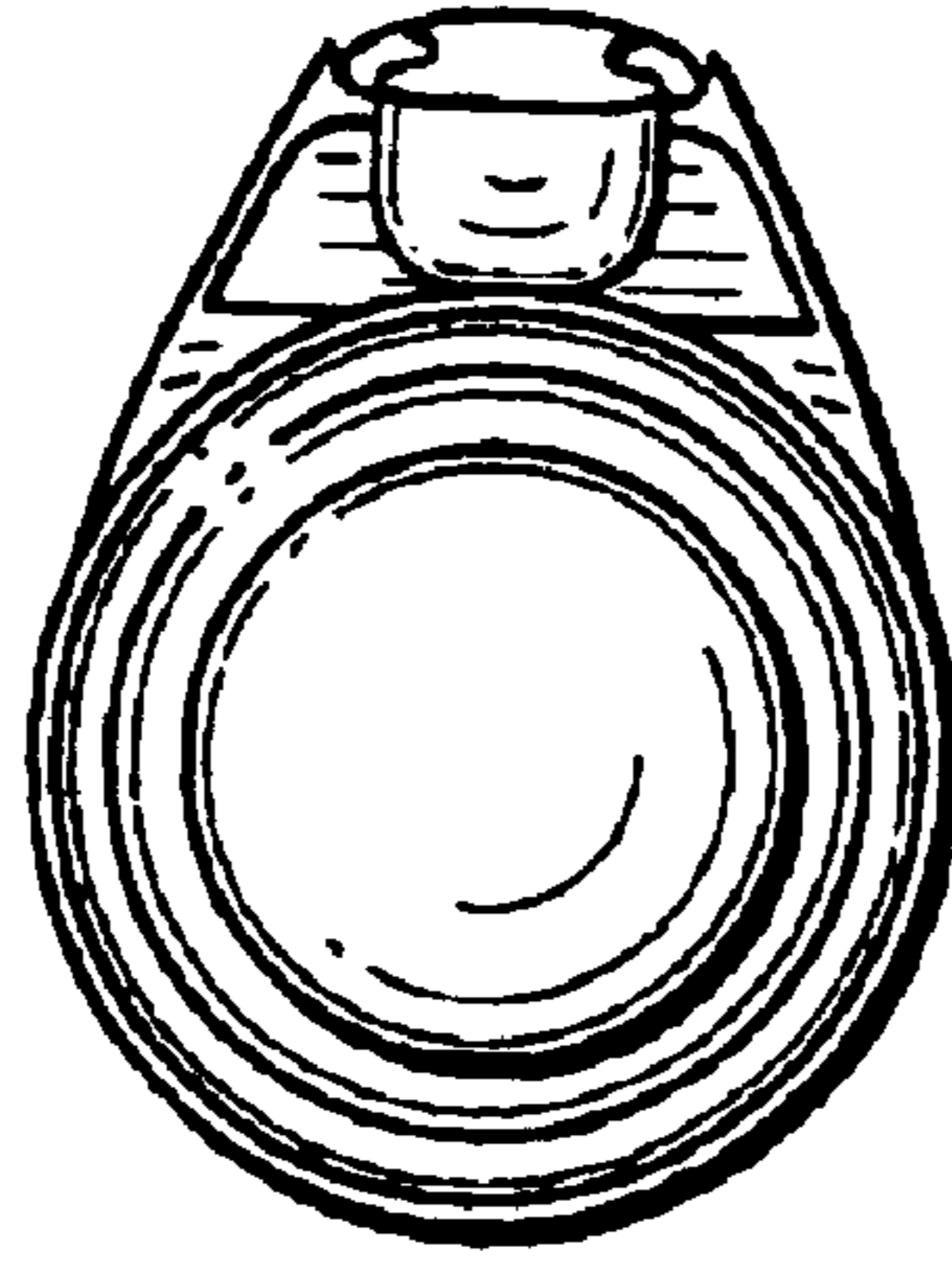


**FIG. 28**





**FIG. 29**



**FIG. 30**

