



US00D438225S

(12) **United States Design Patent**
Sekine

(10) **Patent No.:** **US D438,225 S**

(45) **Date of Patent:** **** Feb. 27, 2001**

(54) **VIDEO CAMERA WITH VIDEO TAPE RECORDER**

(75) **Inventor:** **Tetsuya Sekine, Yokohama (JP)**

(73) **Assignee:** **Canon Kabushiki Kaisha, Tokyo (JP)**

(**) **Term:** **14 Years**

(21) **Appl. No.:** **29/124,549**

(22) **Filed:** **Jun. 8, 2000**

(30) **Foreign Application Priority Data**

Dec. 27, 1999 (JP) 11-36153

(51) **LOC (7) Cl.** **16-01**

(52) **U.S. Cl.** **D16/202**

(58) **Field of Search** D16/200-206,
D16/208; 348/373-376; 352/242, 243; 358/906;
396/535-541

(56) **References Cited**

U.S. PATENT DOCUMENTS

- D. 374,241 * 10/1996 Sekine D16/202
- D. 391,279 * 2/1998 Ohwada D16/202
- D. 396,870 * 8/1998 Ohwada D16/202

- D. 411,849 * 7/1999 Sekine D16/202
- D. 416,031 * 11/1999 Tanaka D16/202
- D. 422,001 * 3/2000 Ohwada D16/202
- 5,444,507 * 8/1995 Palmer 396/421
- 5,499,052 * 3/1996 Nakanishi et al. 348/373

* cited by examiner

Primary Examiner—Adir Aronovich

(74) *Attorney, Agent, or Firm*—Fitzpatrick, Cella, Harper & Scinto

(57) **CLAIM**

The ornamental design for a video camera with video tape recorder, as shown and described.

DESCRIPTION

FIG. 1 is a front view of a video camera with video tape recorder showing my new design;
 FIG. 2 is a rear view thereof;
 FIG. 3 is a top plan view thereof;
 FIG. 4 is a bottom plan view thereof;
 FIG. 5 is a left side view thereof;
 FIG. 6 is a right side view thereof; and,
 FIG. 7 is a perspective view thereof.

1 Claim, 6 Drawing Sheets

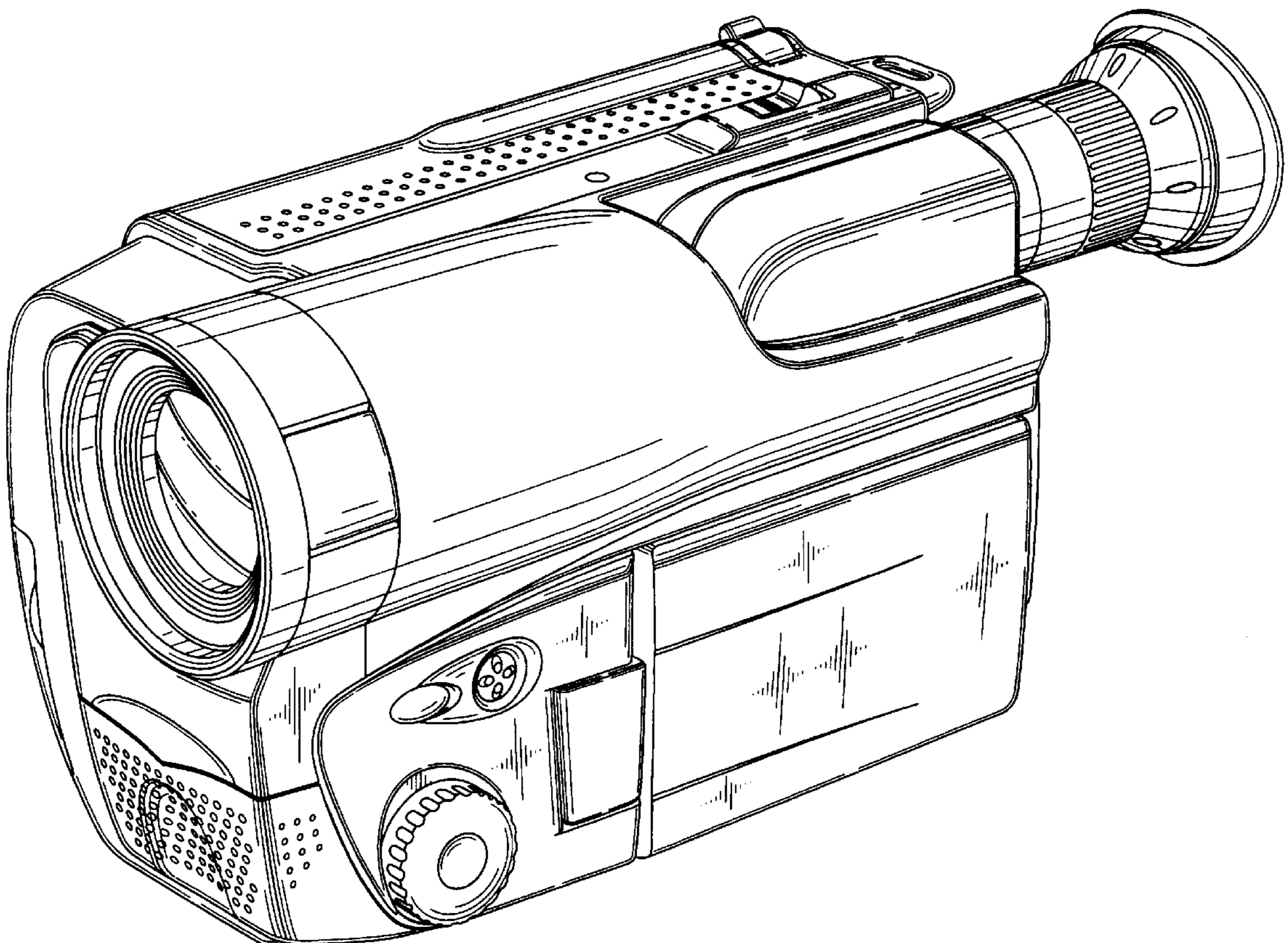

FIG. 1

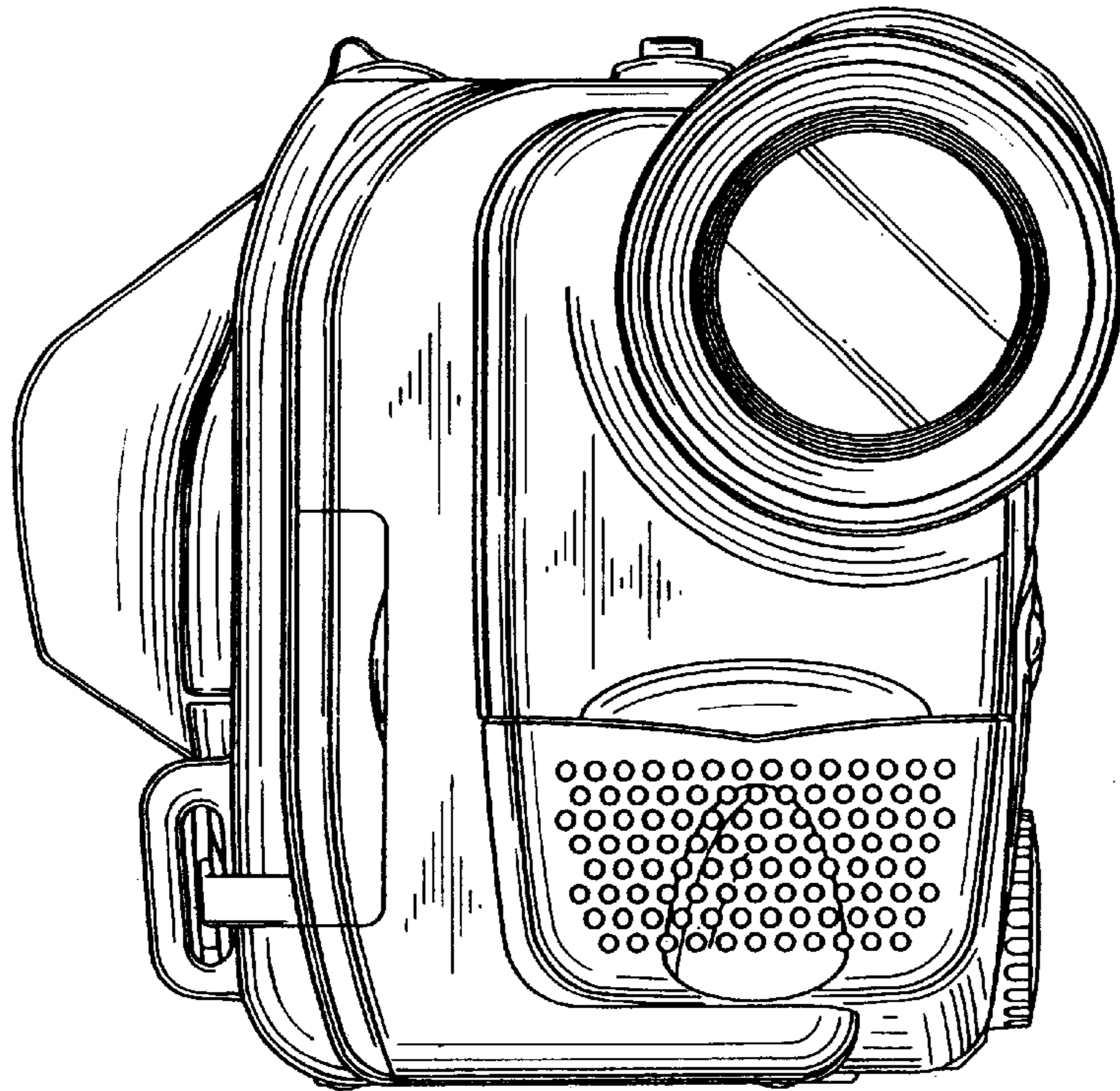

FIG. 2

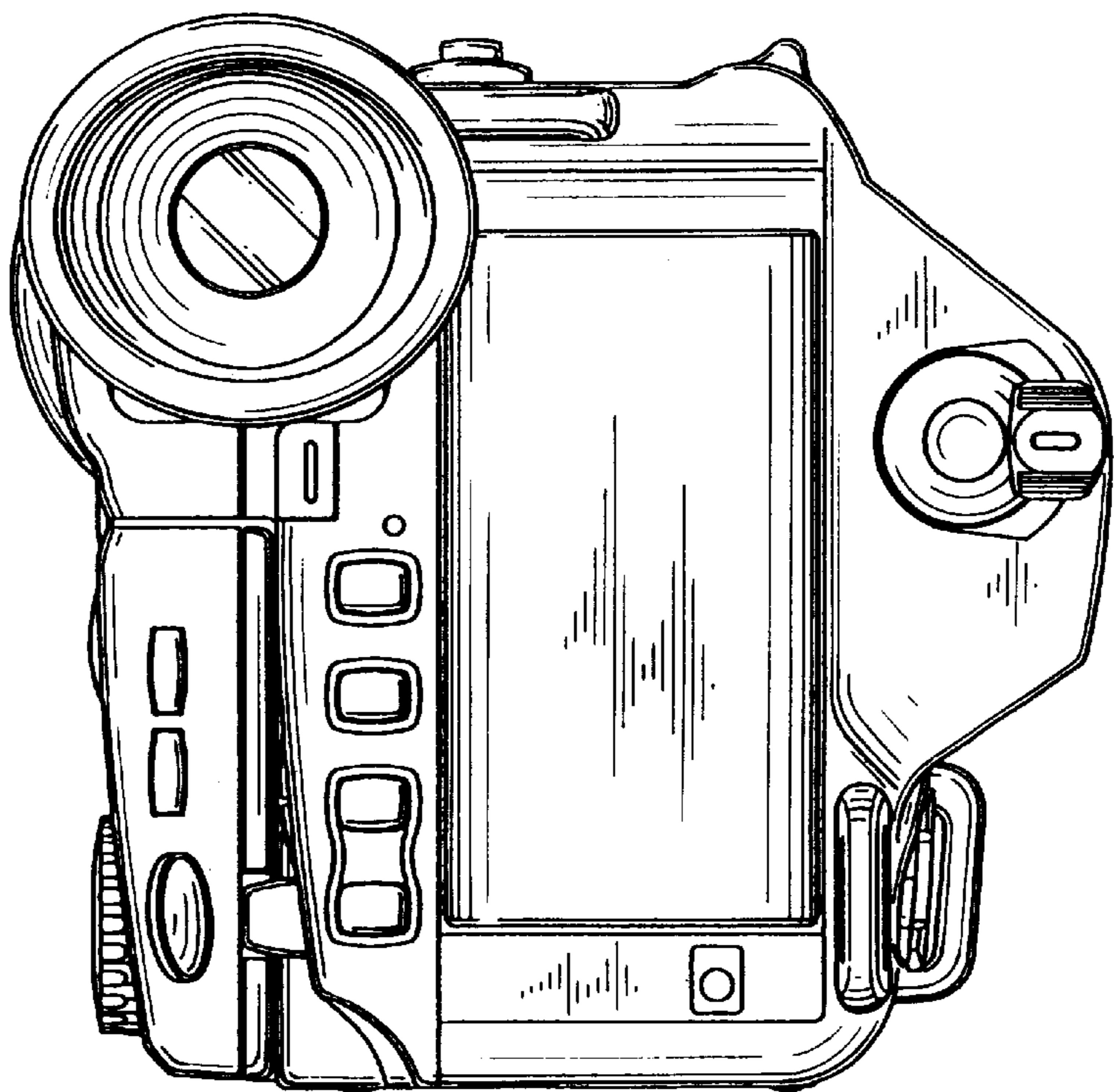

FIG. 3

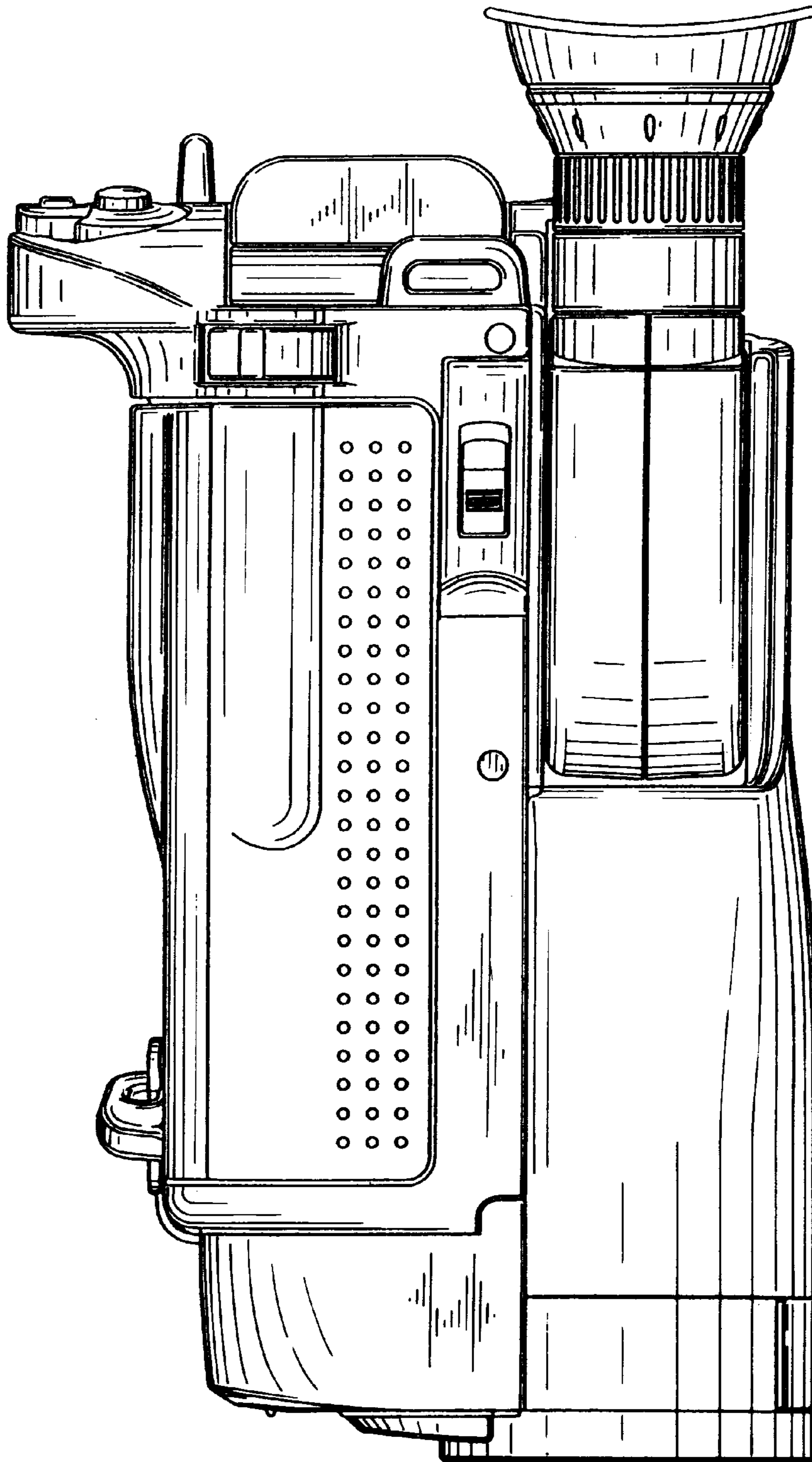

FIG. 4

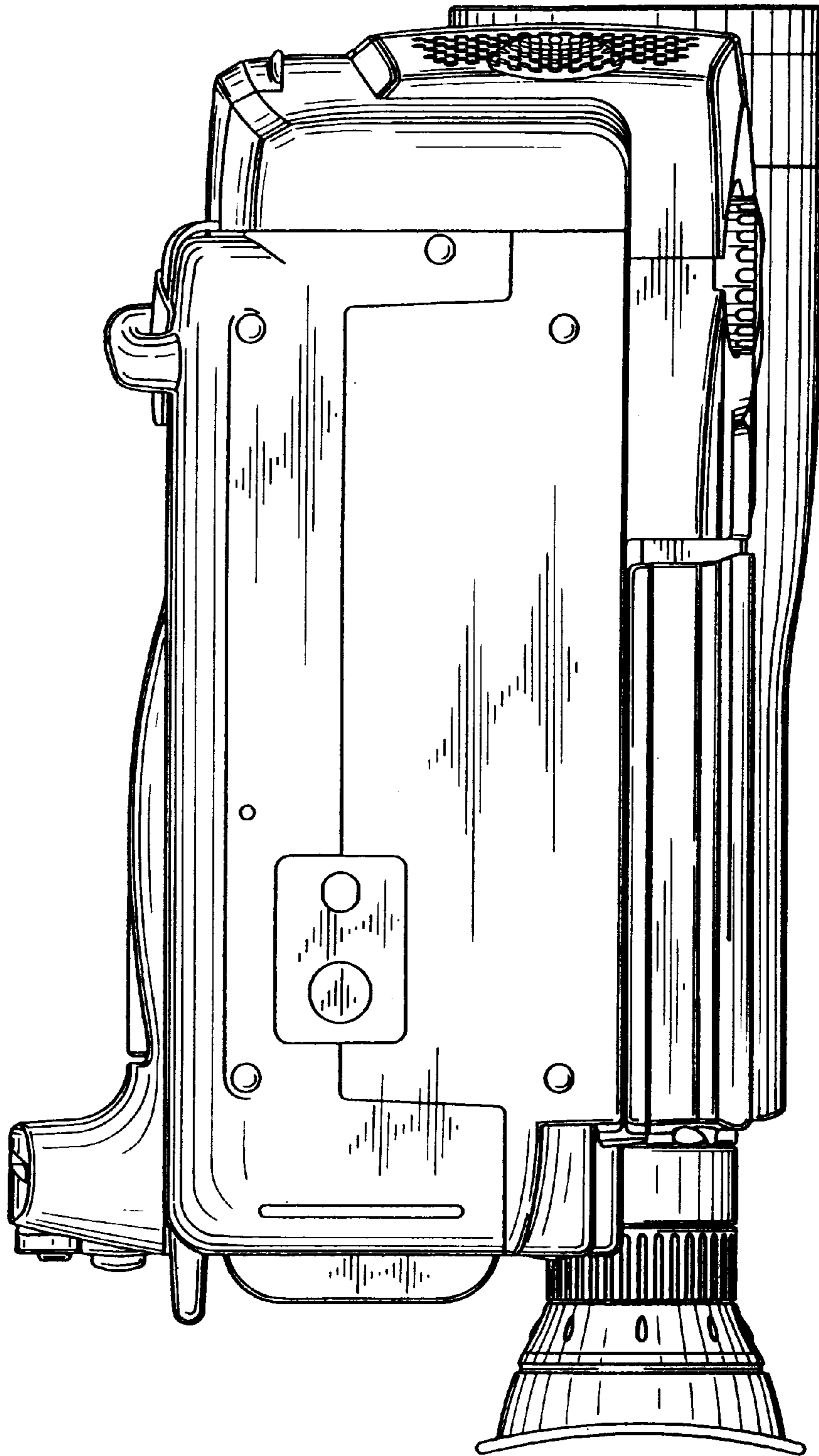

FIG. 5

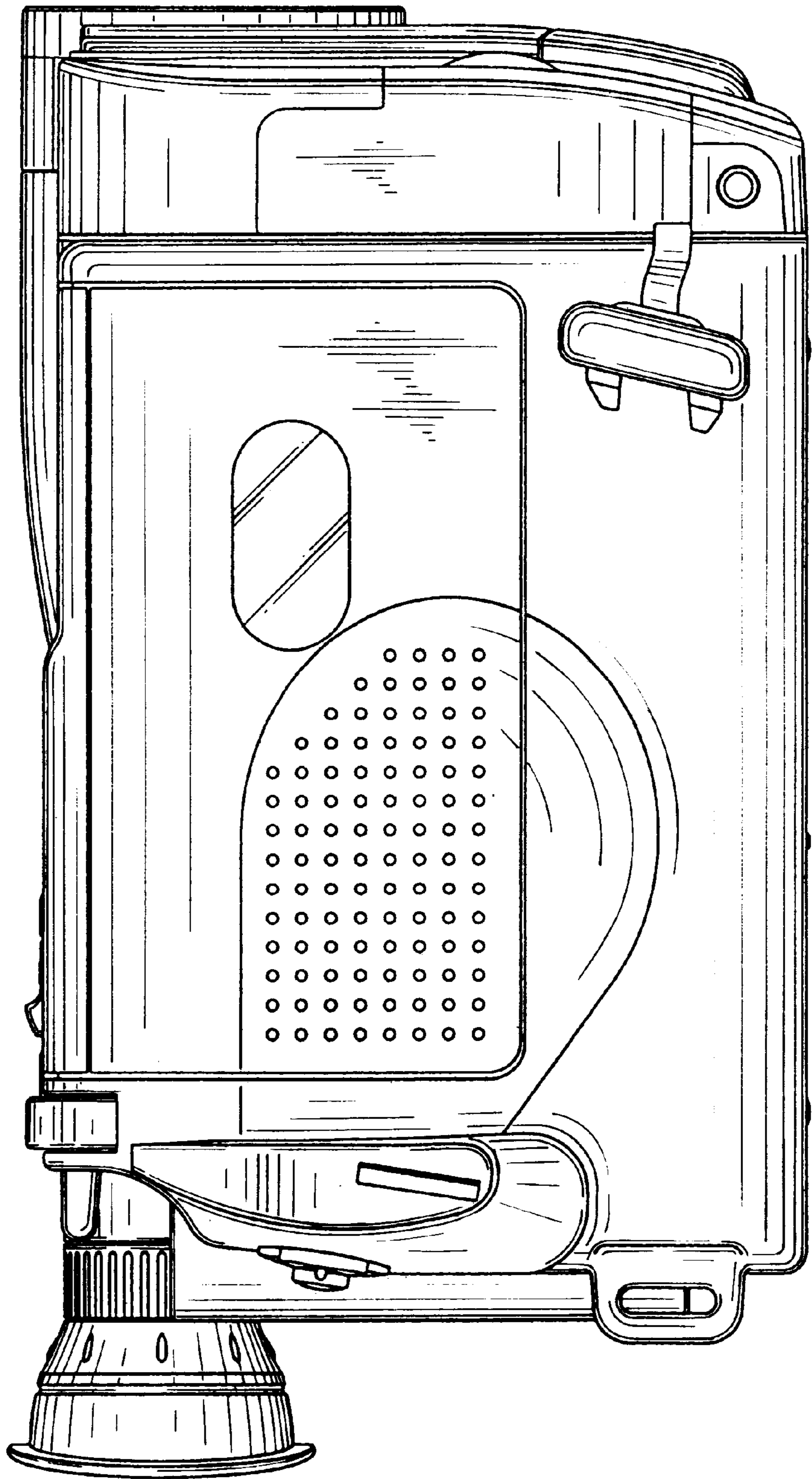

FIG. 6

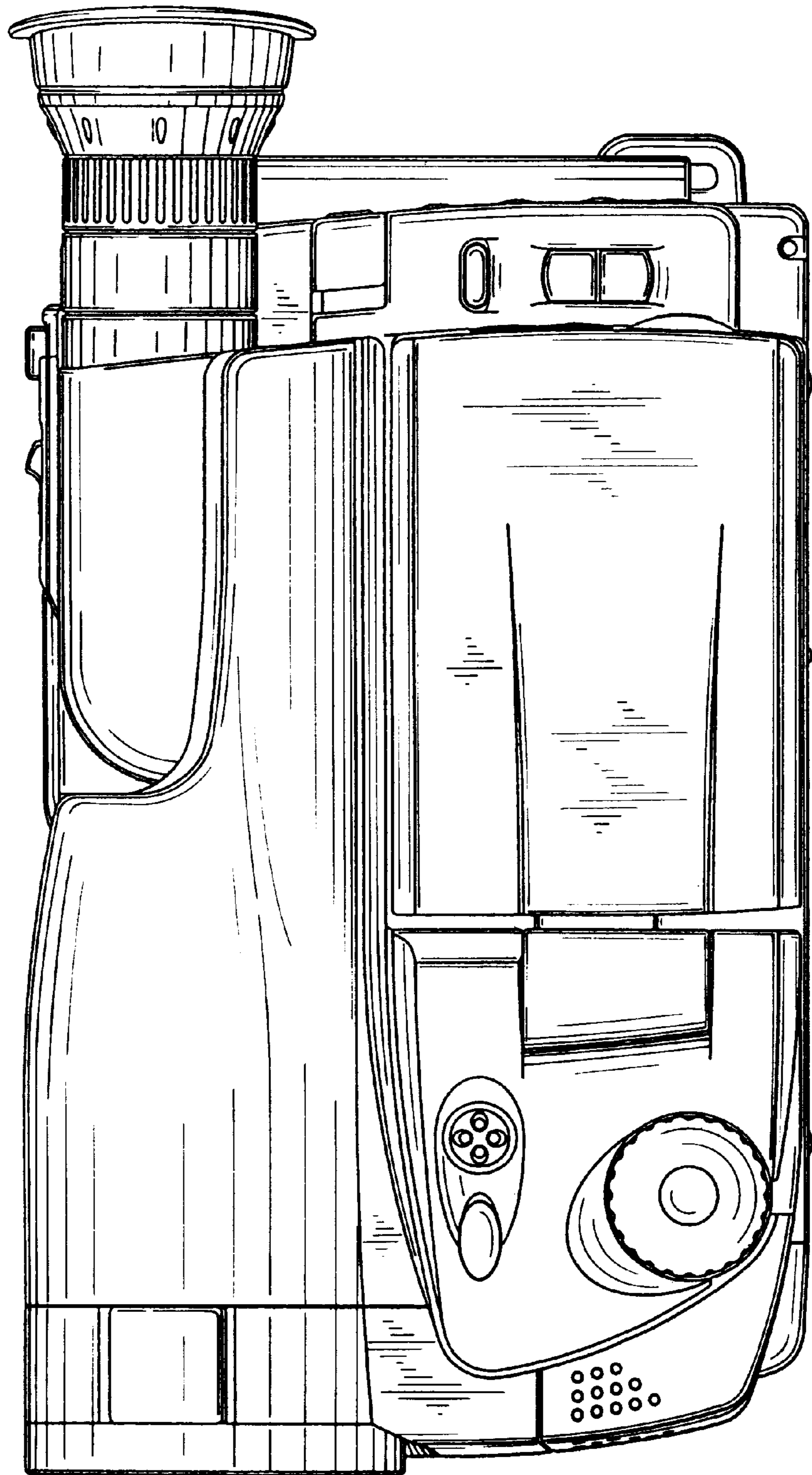

FIG. 7

