



US00D438177S

(12) **United States Design Patent** (10) **Patent No.:** **US D438,177 S**
Rogers (45) **Date of Patent:** **** Feb. 27, 2001**

(54) **CABLE MANAGEMENT RACK**

(76) Inventor: **Joseph W. Rogers**, 3960 E. Bailey Rd.,
Monticello, IN (US) 47960

(**) Term: **14 Years**

(21) Appl. No.: **29/117,240**

(22) Filed: **Jan. 20, 2000**

(51) **LOC (7) Cl.** **13-03**

(52) **U.S. Cl.** **D13/199**

(58) **Field of Search** D13/154, 199;
361/826; 379/326, 327; 211/26

(56) **References Cited**

U.S. PATENT DOCUMENTS

D. 289,636	5/1987	Maurer et al. .	
D. 292,974	12/1987	Kenning et al. .	
D. 360,189	7/1995	Orlando .	
4,496,057	1/1985	Zenitani et al. .	
4,497,411	2/1985	DeBortoli .	
4,641,754	2/1987	Hebel et al. .	
4,715,502	12/1987	Salmon .	
5,323,916	6/1994	Salmon .	
5,566,836	* 10/1996	Lerman	211/26
5,586,012	12/1996	Lerman .	
5,683,001	* 11/1997	Masuda et al.	211/26
5,788,087	* 8/1998	Orlando	211/26
5,867,372	* 2/1999	Shie	361/826
5,975,315	* 11/1999	Jordan	211/26
5,983,590	* 11/1999	Serban	211/26 X
6,006,925	* 12/1999	Sevier	211/26

OTHER PUBLICATIONS

Newton Instrument Company, Inc., *Catalog No. 14, Telephone Office Structural Components* (1993).
 VERO Electronics, Inc., *Catalog: IMRAK and Networking Products* (1994).
 ADC Telecommunications, Inc., *Catalog: Professional Audio and Video Products, 4th Edition*(Apr. 1993).
 Henry Telephone Products, *Product Catalogs* (1993, 1994).
 Chatsworth Products, Inc., *Catalog: Datacom Framework Systems* (Mar. 1995).

Precision Fabrication Technologies, Inc., *Catalog: Modular Enclosures & Data Comm Products* (1996).

PFT, A ZERO Corporation Company, *Product Catalog* (Jul. 1997 or before).

PFT, Inc., *Brochure: Data Comm Products* (Jul. 1997 or before).

Ortronics, *Catalog: System Solutions Product Guide* (1995).

Electronic Metal Products, Inc., *Advertisement: The Sky's the Limit* (Sep. 1996).

Rittal, *Advertisement* (1995).

CPI Wire Management Systems, *Advertisement: The New CatRack Wire Management System*, (Sep. 1996).

DataTel, *Catalog: Data, Networking, Communication, System mounting Solutions*, pp. 1-4 (Spring 96).

Hendry Telephone Products, *Catalog page* (May 1996).

Devtek Electronic Packaging Systems, *Hot Sheet* (1995).

DevTek Electronic Packaging Systems, *Catalog: Enclosure Solutions* (Apr. 95).

* cited by examiner

Primary Examiner—Joel Sincavage
(74) *Attorney, Agent, or Firm*—Woodard, Emhardt, Naughton, Moriarty & McNett

(57) **CLAIM**

The ornamental design for a cable management rack, as shown and described.

DESCRIPTION

FIG. 1 is a front perspective view of the cable management rack incorporating my new design.

FIG. 2 is a front view.

FIG. 3 is a left side view.

FIG. 4 is a rear view.

FIG. 5 is a right side view.

FIG. 6 is a top view; and,

FIG. 7 is a bottom view.

1 Claim, 4 Drawing Sheets

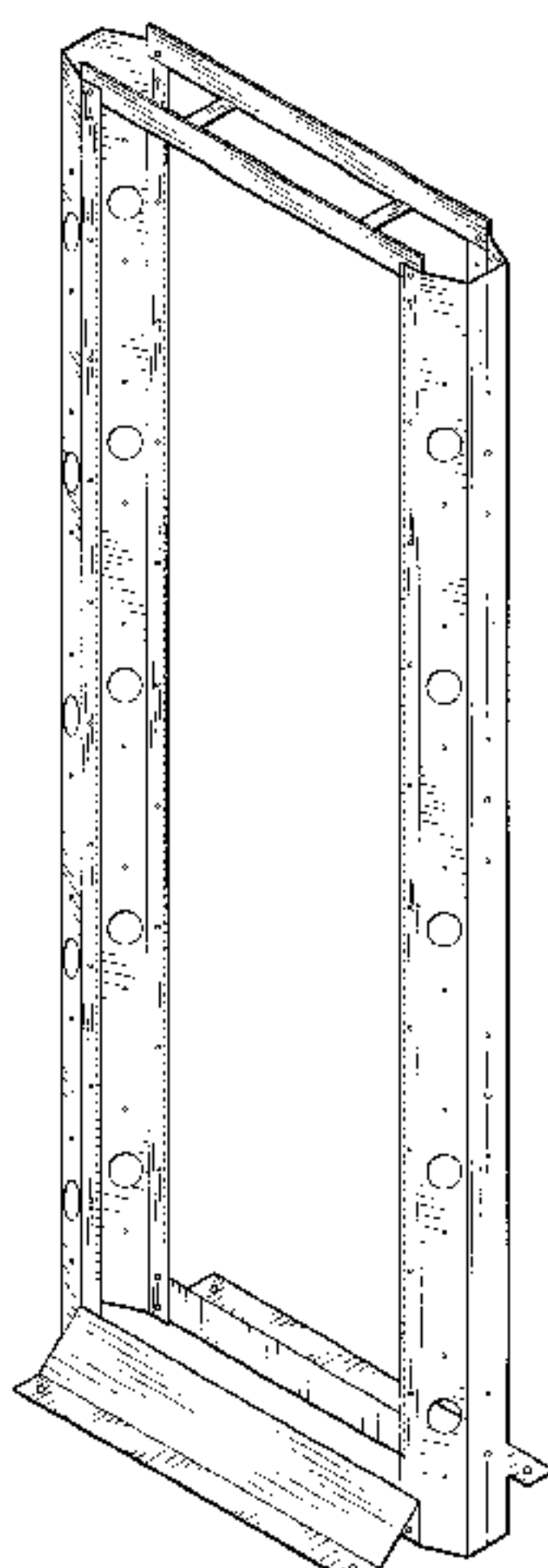

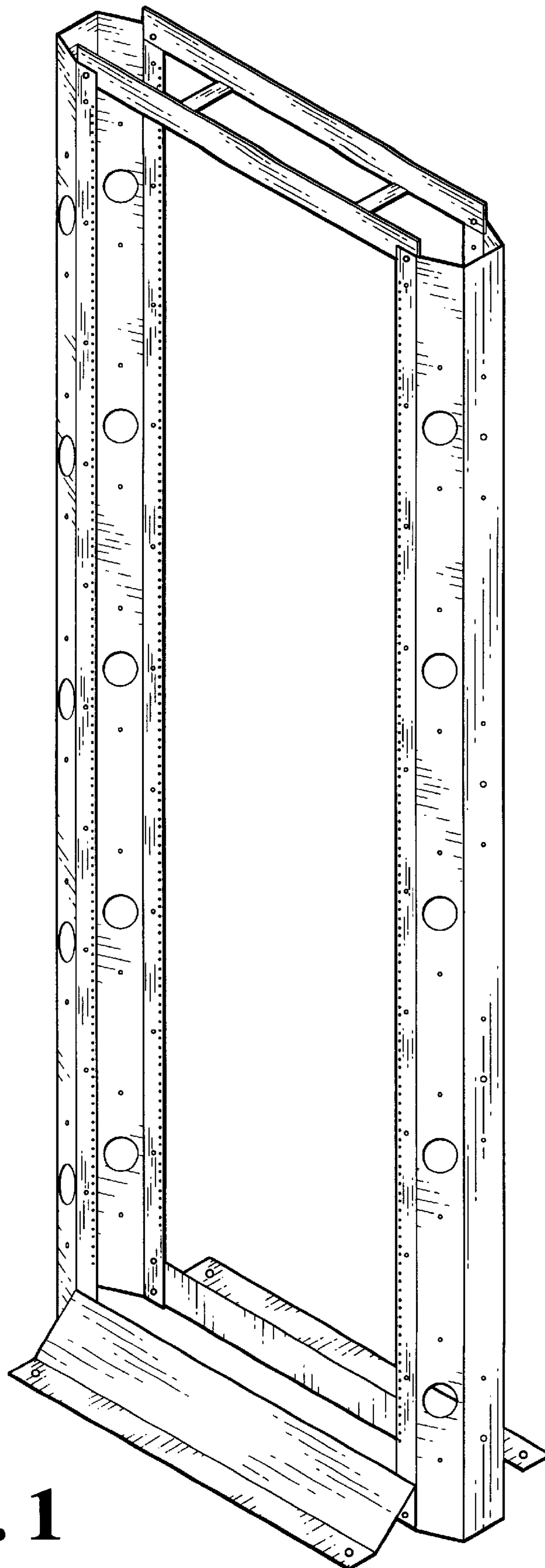

Fig. 1

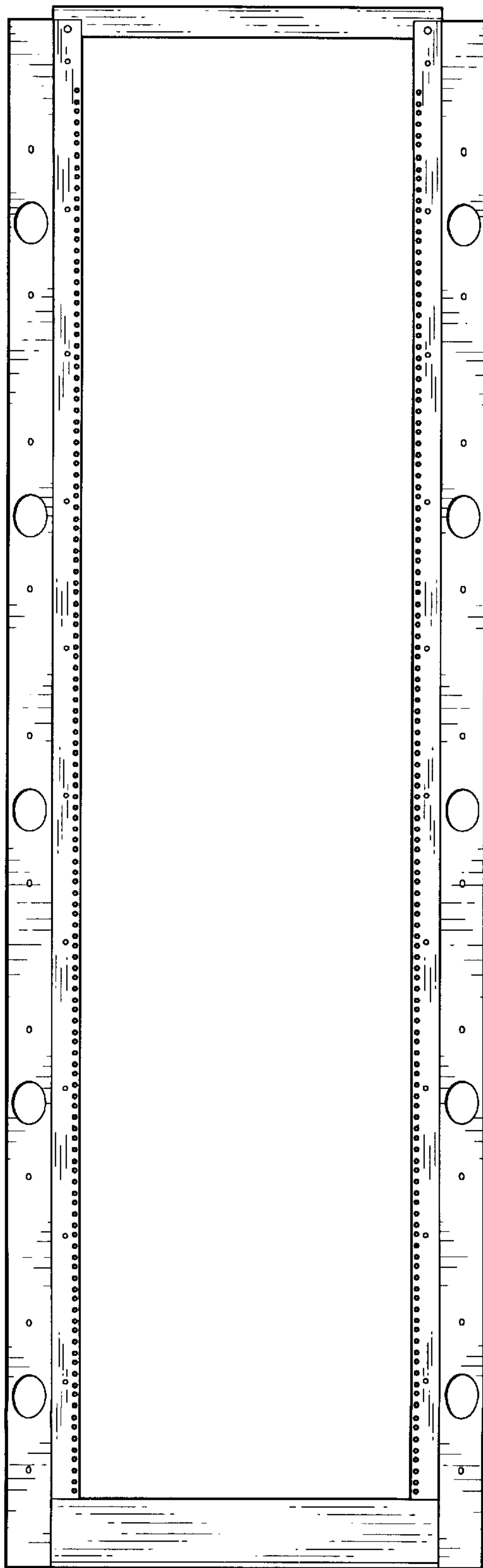

Fig. 2

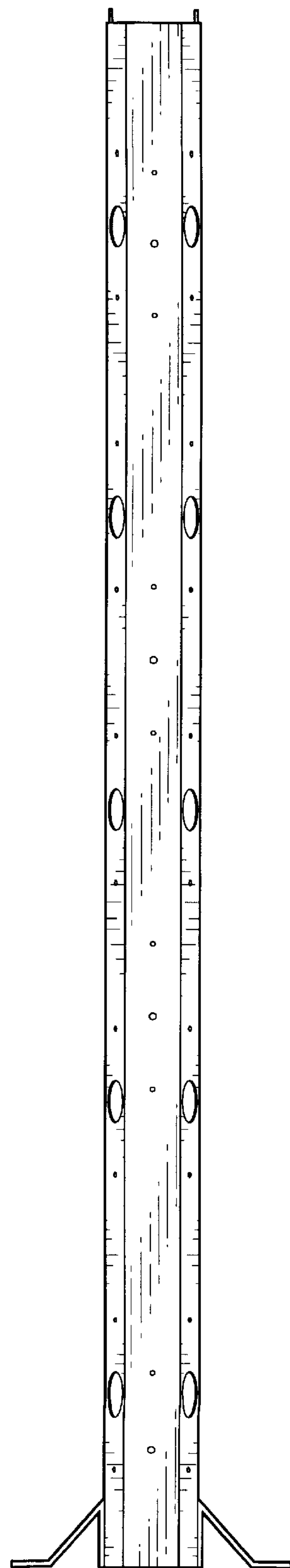

Fig. 3

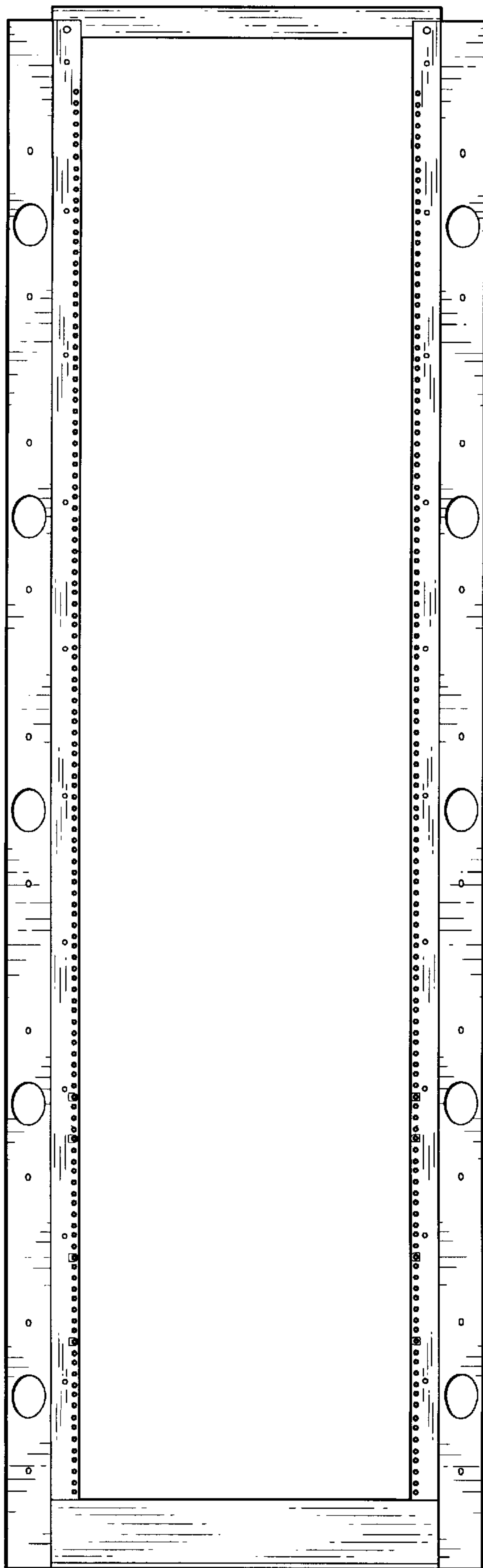

Fig. 4

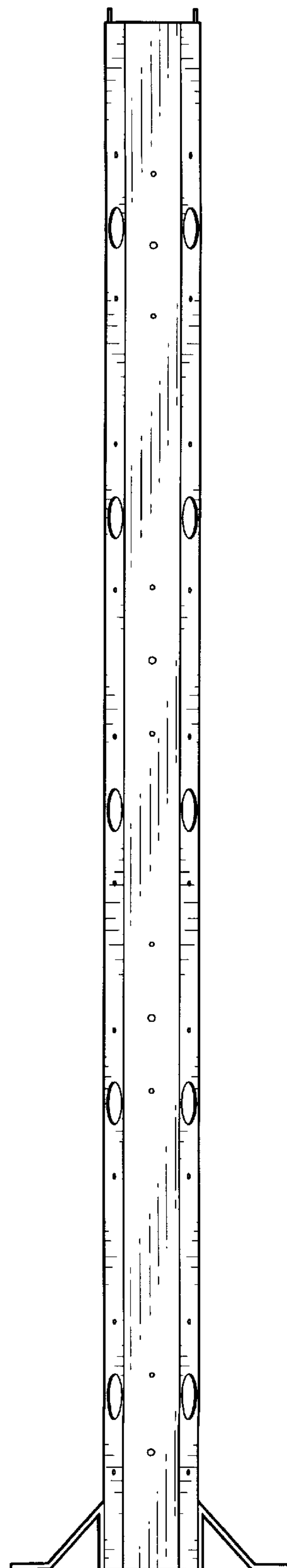

Fig. 5

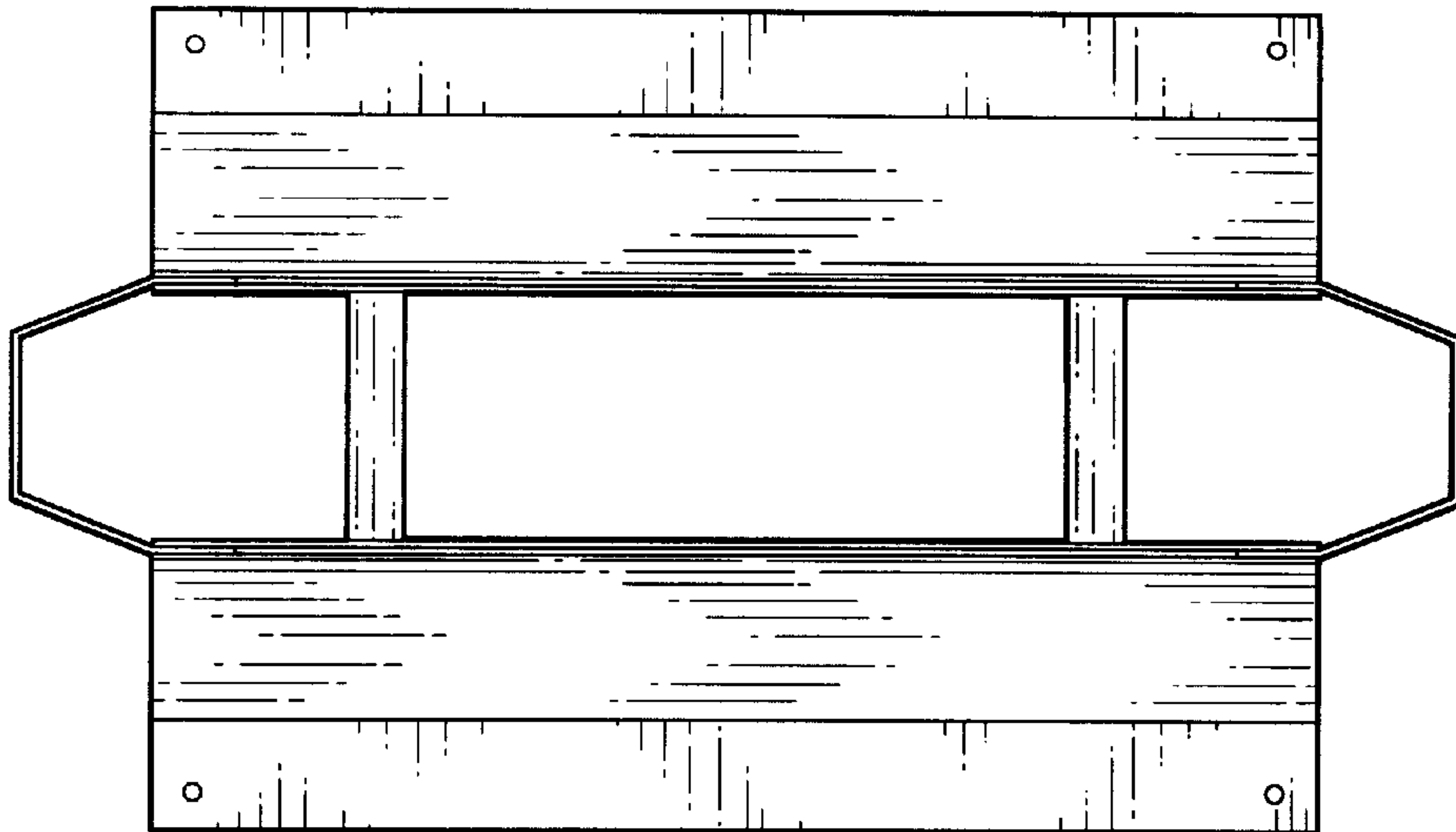

Fig. 6

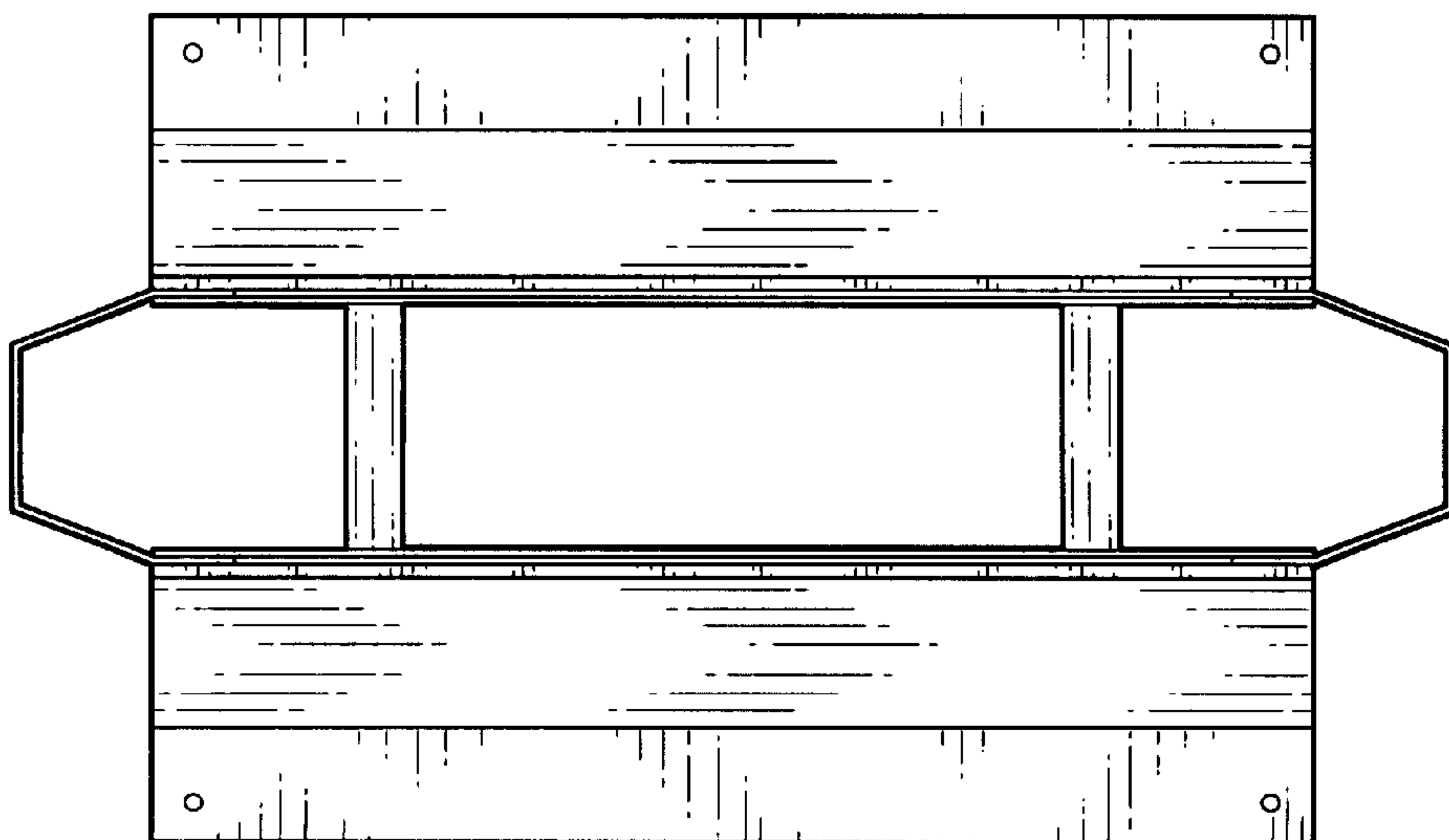

Fig. 7