



US00D438024S

(12) **United States Design Patent**
Catalano et al.

(10) **Patent No.:** **US D438,024 S**

(45) **Date of Patent:** **** Feb. 27, 2001**

(54) **STOOL**

(75) Inventors: **Carol Rhodes Catalano; Aaron Double; Adam Wells**, all of Boston, MA (US)

(73) Assignee: **Catalano Design**, Boston, MA (US)

(**) Term: **14 Years**

(21) Appl. No.: **29/105,039**

(22) Filed: **May 17, 1999**

(51) **LOC (7) Cl.** **06-01**

(52) **U.S. Cl.** **D6/349**

(58) **Field of Search** D6/349-353, 355; 297/461, 462, 423.1, 423.39, 423.41, 423.43

(56) **References Cited**

U.S. PATENT DOCUMENTS

D. 200,466	*	3/1965	Eby	D6/349
2,914,117		11/1959	Underwood	.	
4,235,473		11/1980	Aginar	.	
4,702,521	*	10/1987	Bae	297/440.1
4,792,182		12/1988	McLeod	.	

FOREIGN PATENT DOCUMENTS

671528 11/1950 (GB) .

OTHER PUBLICATIONS

Bentwood Stool, designed by Sori Yanagi, photo, 1956.

Steamer Collection Chair, designed by Thomas Lamb, furniture book, 1982.

Schoner Wohnen, Oct. 1996, p. 180, table at top right.*

* cited by examiner

Primary Examiner—Janice E. Seeger

(74) *Attorney, Agent, or Firm*—SAIDMAN DesignLaw Group

(57) **CLAIM**

The ornamental design for a stool, as shown and described.

DESCRIPTION

FIG. 1 is a perspective view of a stool showing our new design;

FIG. 2 is a front view thereof, the rear view being identical thereto the broken lines showing the possible layering on the edge and the foot are for environmental purposes only and form no part of the claimed design;

FIG. 3 is a left side view thereof, the right side view being identical thereto the broken lines showing the foot and bottom edge are for environmental purposes only and form no part of the claimed design;

FIG. 4 is a top view thereof;

FIG. 5 is a bottom view thereof the broken lines showing the foot and bottom edge are for environmental purposes only and form no part of the claimed design;

FIG. 6 is a front view of a second embodiment of a stool showing our new design the broken lines showing the possible layering on the edge bottom stretcher are for environmental purposes only and form no part of the claimed design;

FIG. 7 is a left side view thereof, the right side view being identical thereto the broken lines showing the possible notch and bottom stretcher are for environmental purposes only and form no part of the claimed design;

FIG. 8 is a top view thereof;

FIG. 9 is a bottom view thereof the broken lines showing the possible notch and bottom stretcher are for environmental purposes only and form no part of the claimed design;

FIG. 10 is a front view of a third embodiment of a stool showing our new design the broken lines showing the possible feet are for environmental purposes only and form no part of the claimed design;

FIG. 11 is a left side view thereof, the right side view being identical thereto the broken lines showing the possible feet are for environmental purposes only and form no part of the claimed design;

FIG. 12 is a top view thereof; and,

FIG. 13 is a bottom view thereof the broken lines showing the possible feet are for environmental purposes only and form no part of the claimed design.

1 Claim, 13 Drawing Sheets

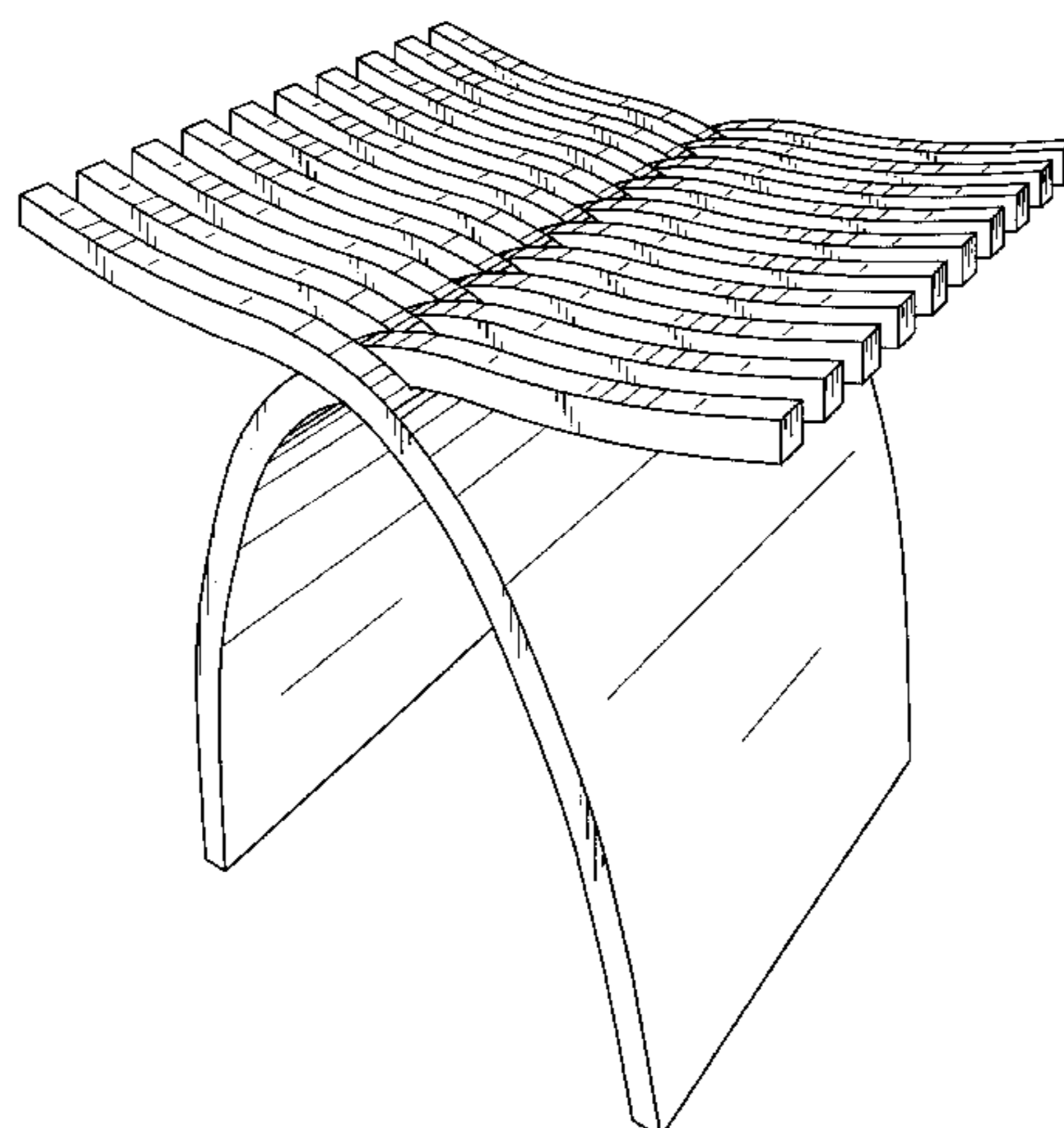

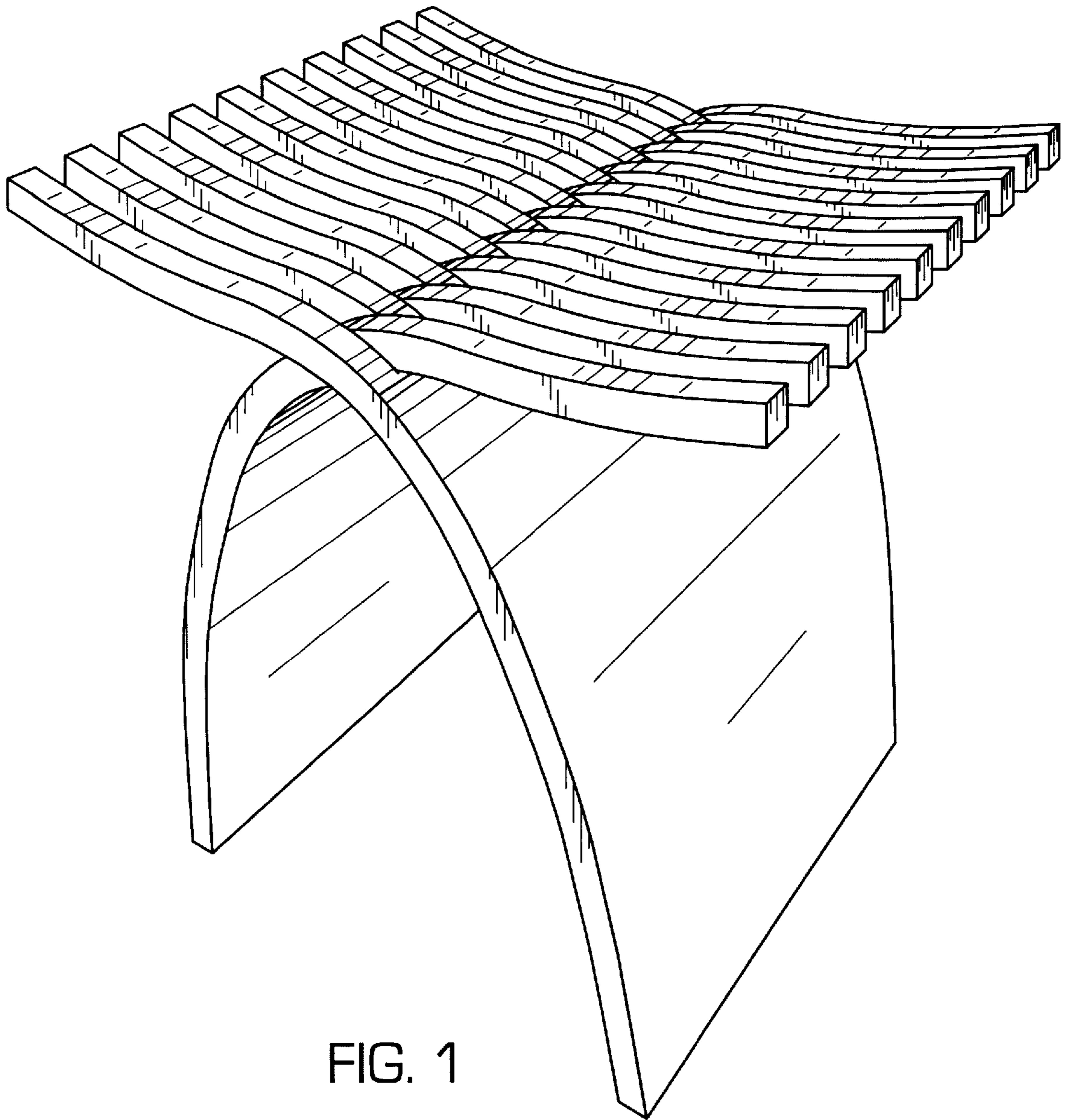

FIG. 1

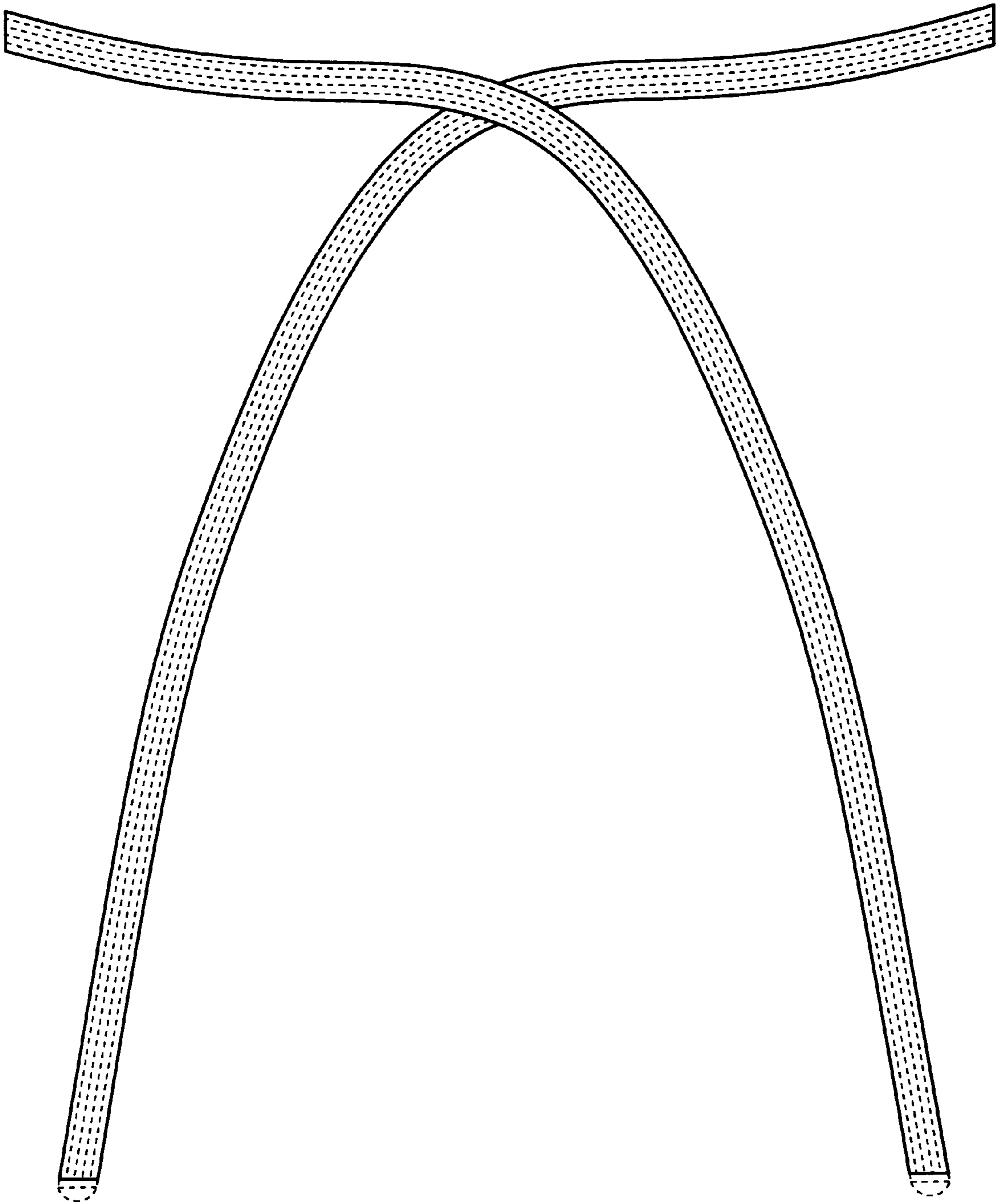

FIG. 2

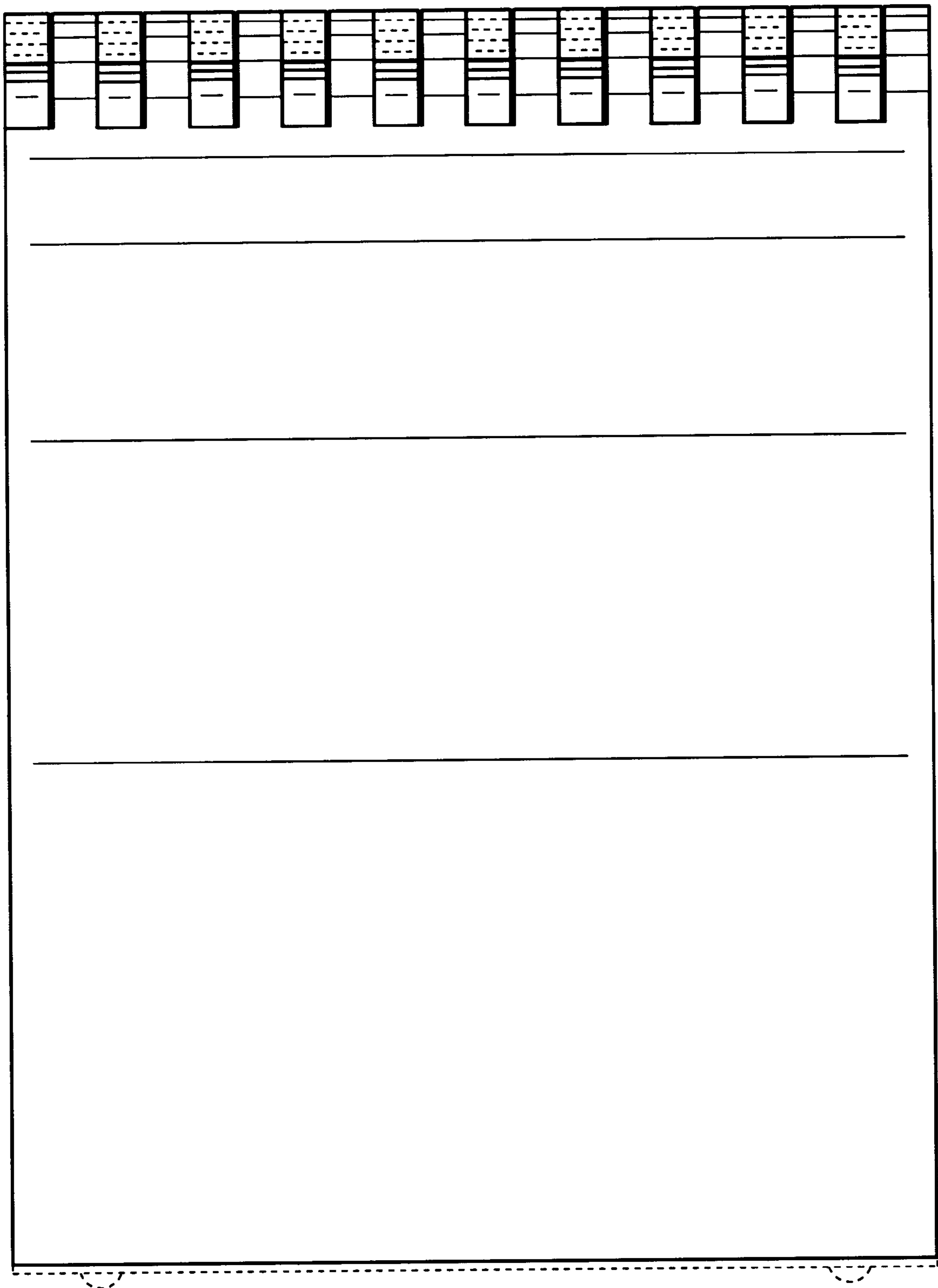

FIG. 3

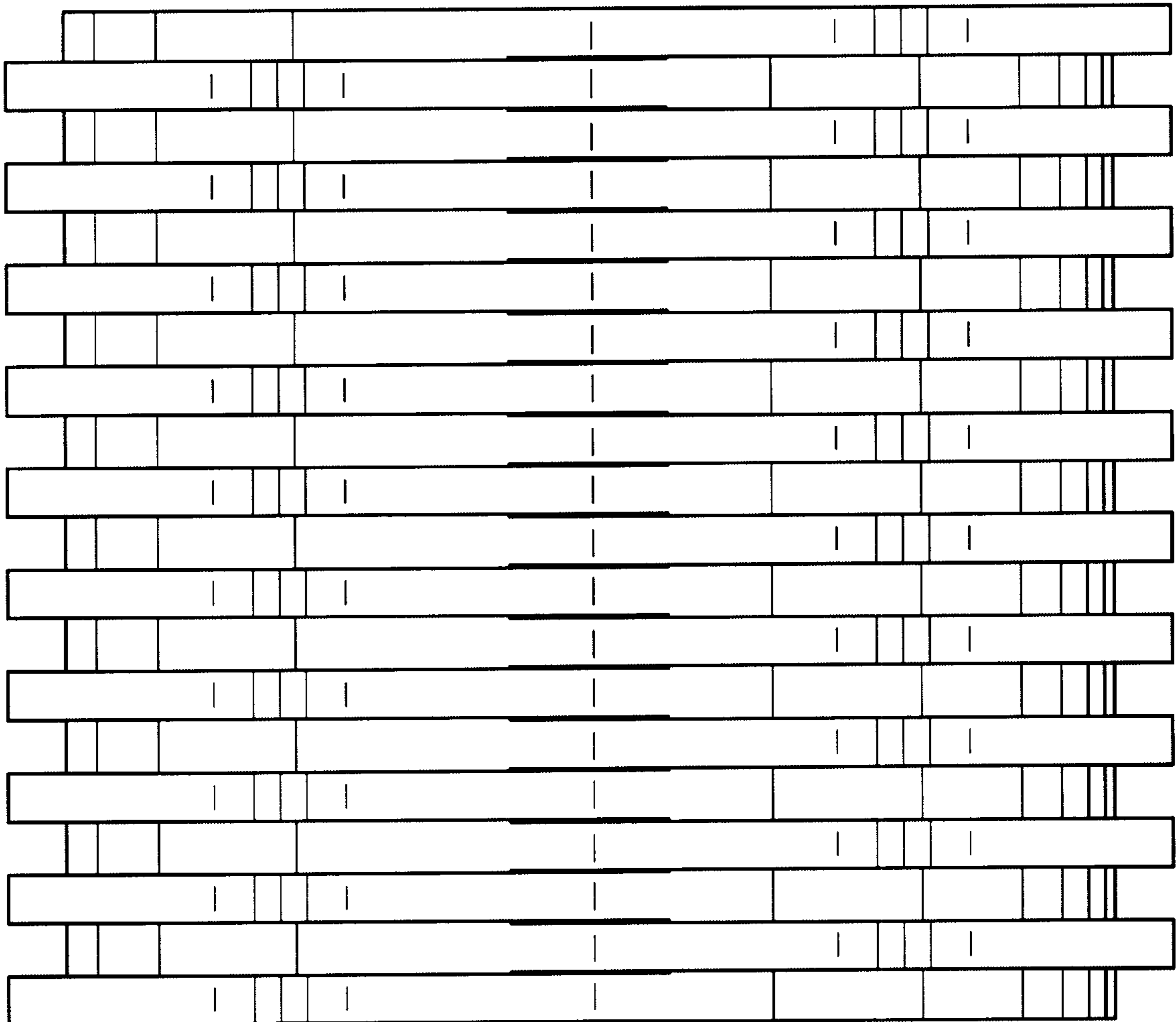

FIG. 4

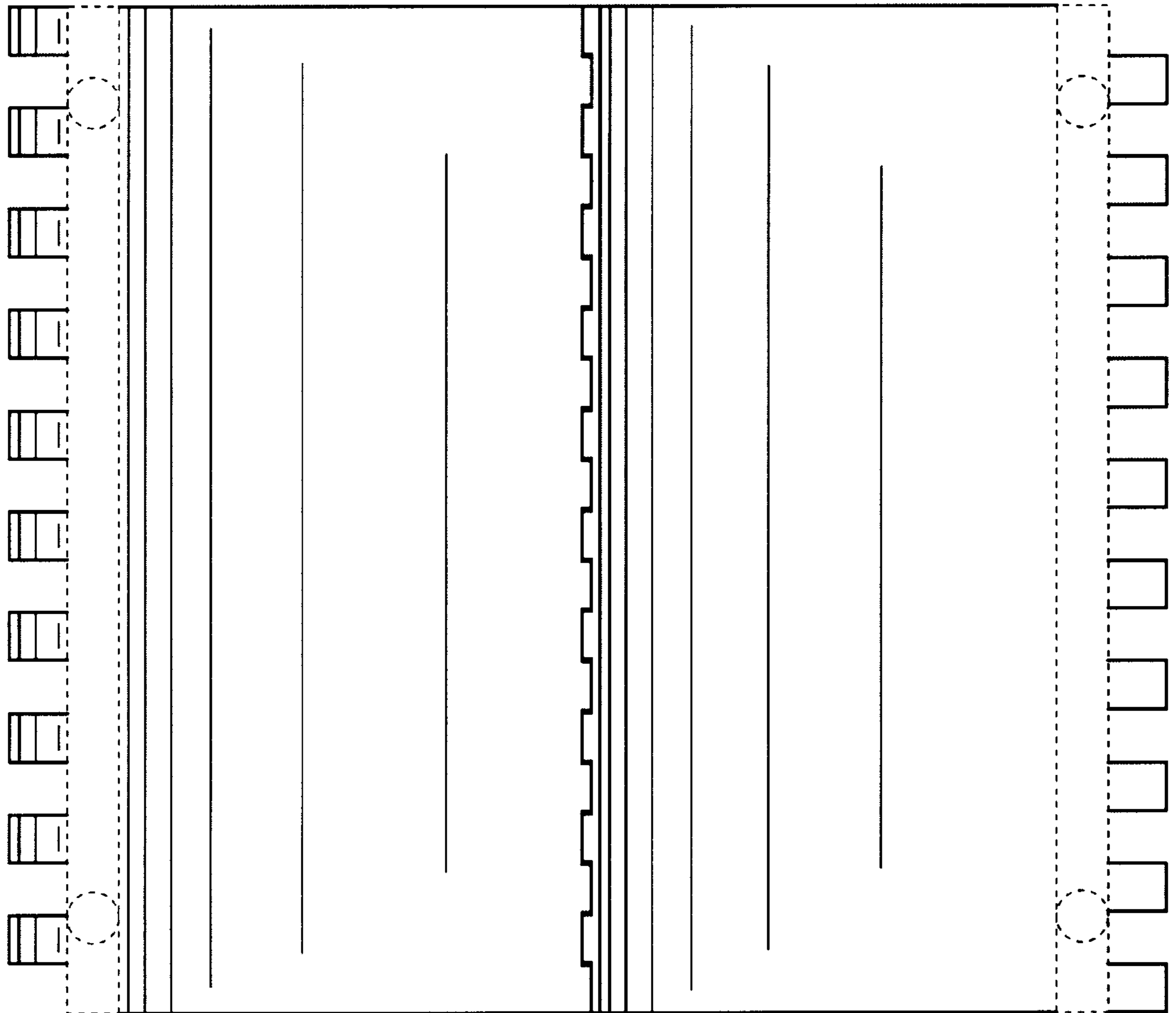

FIG. 5

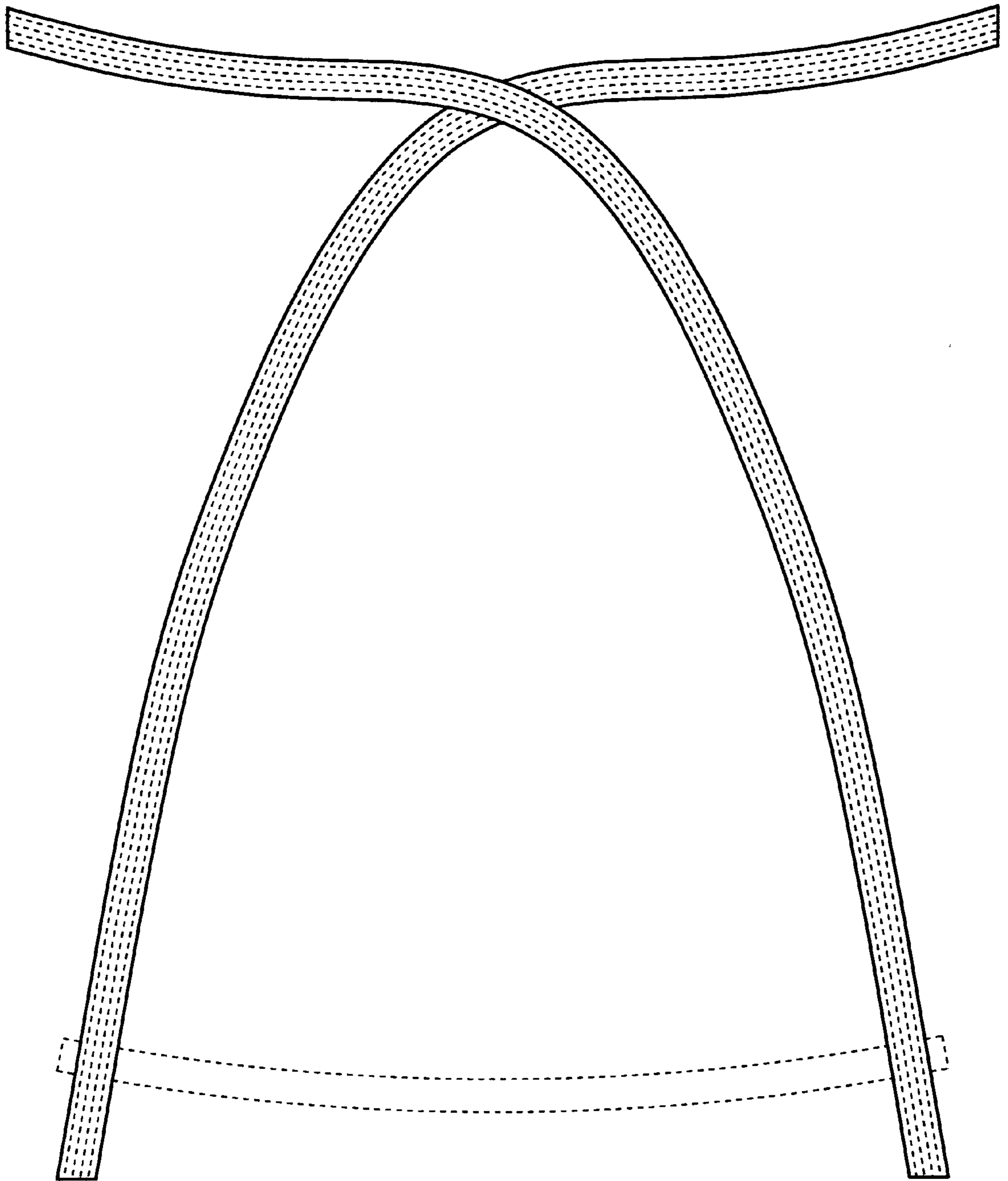

FIG. 6

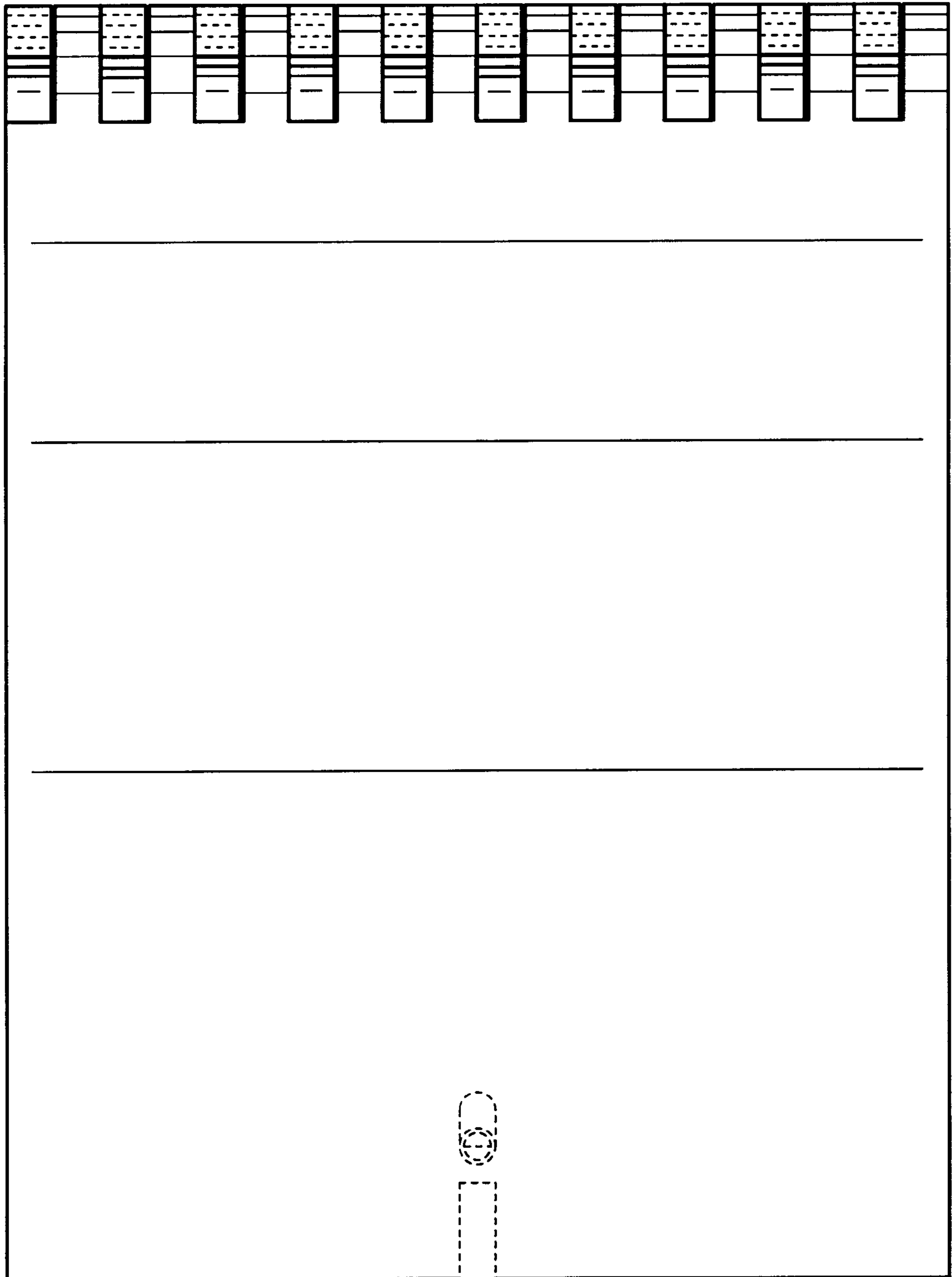

FIG. 7

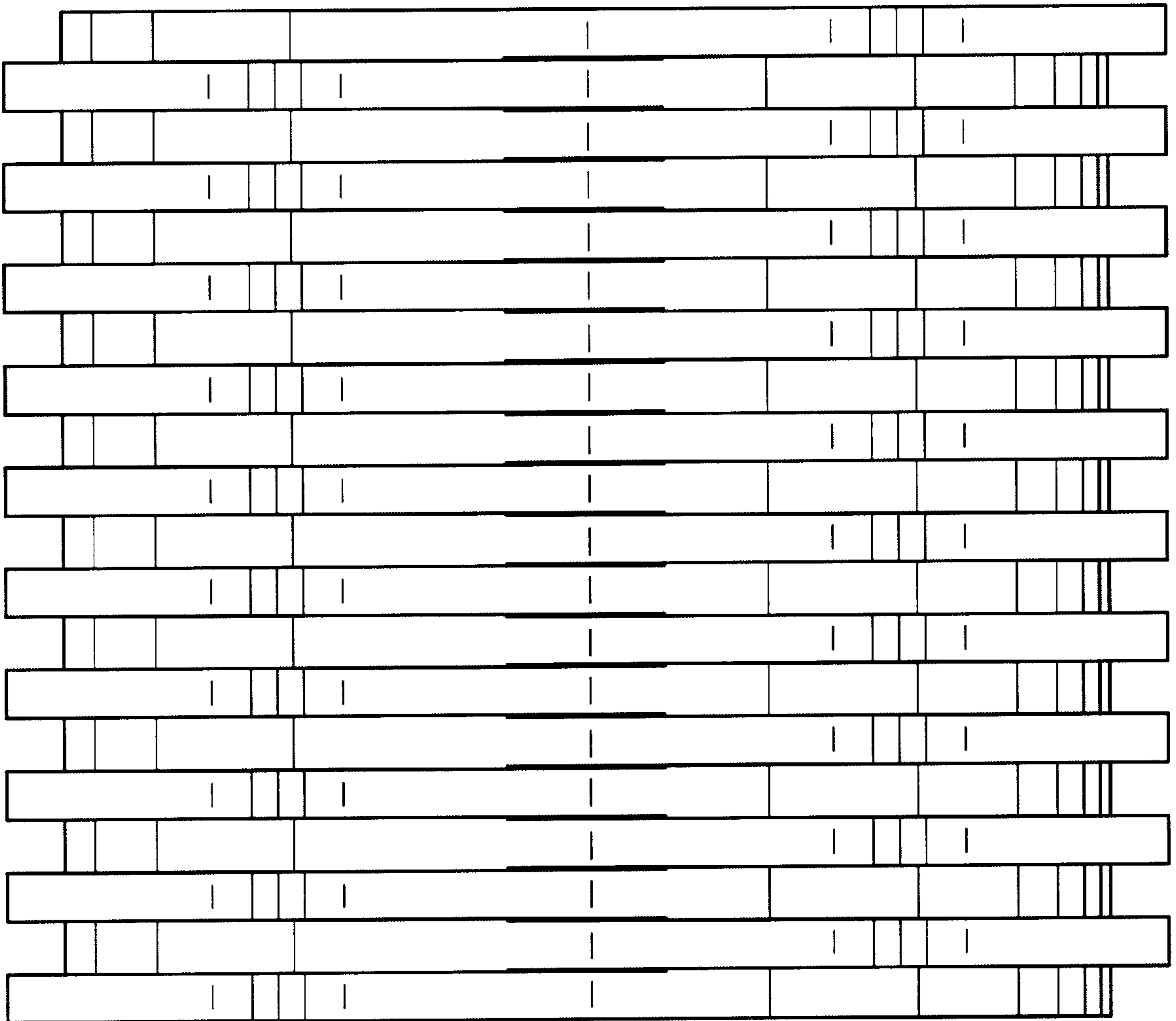

FIG. 8

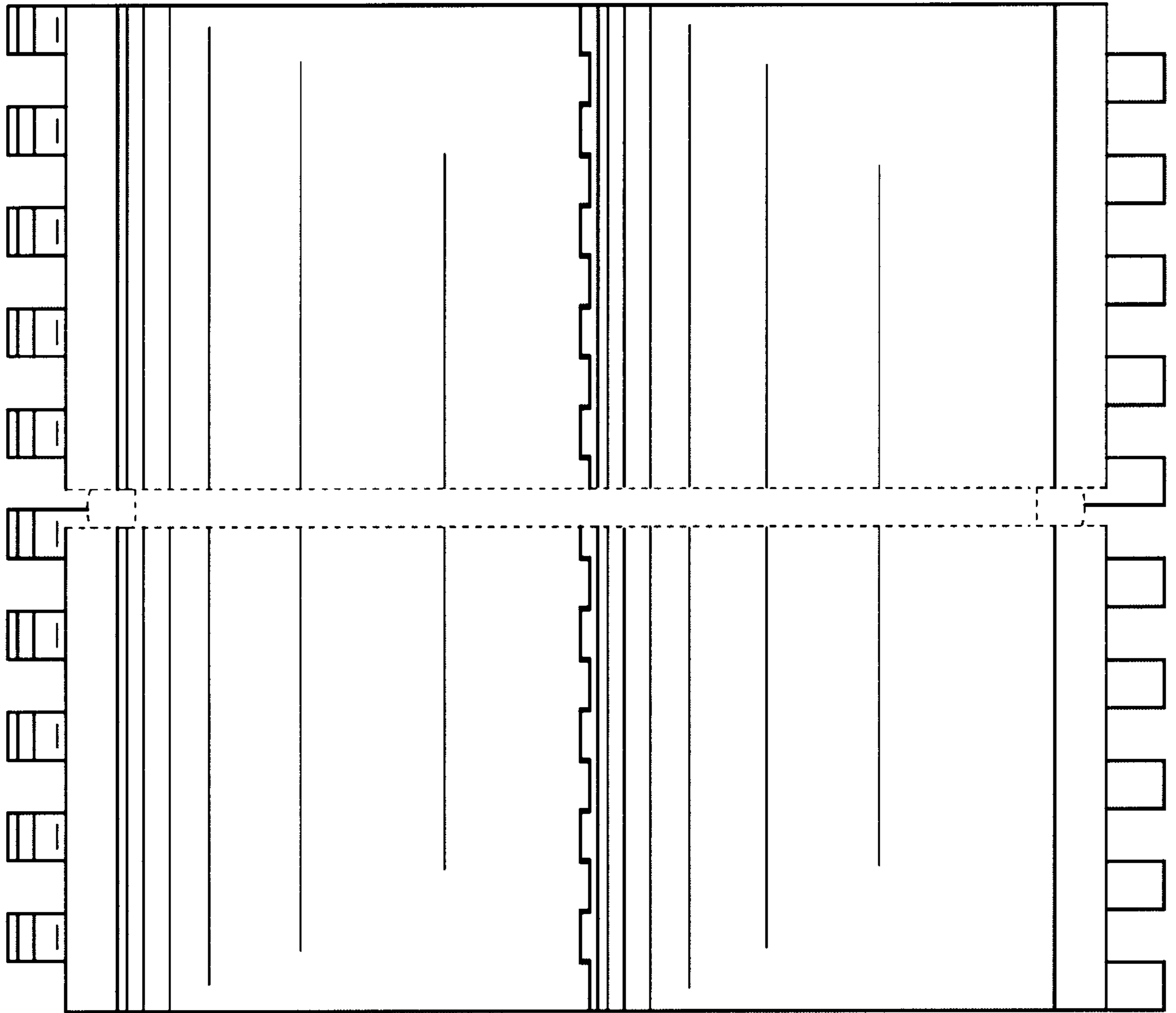

FIG. 9

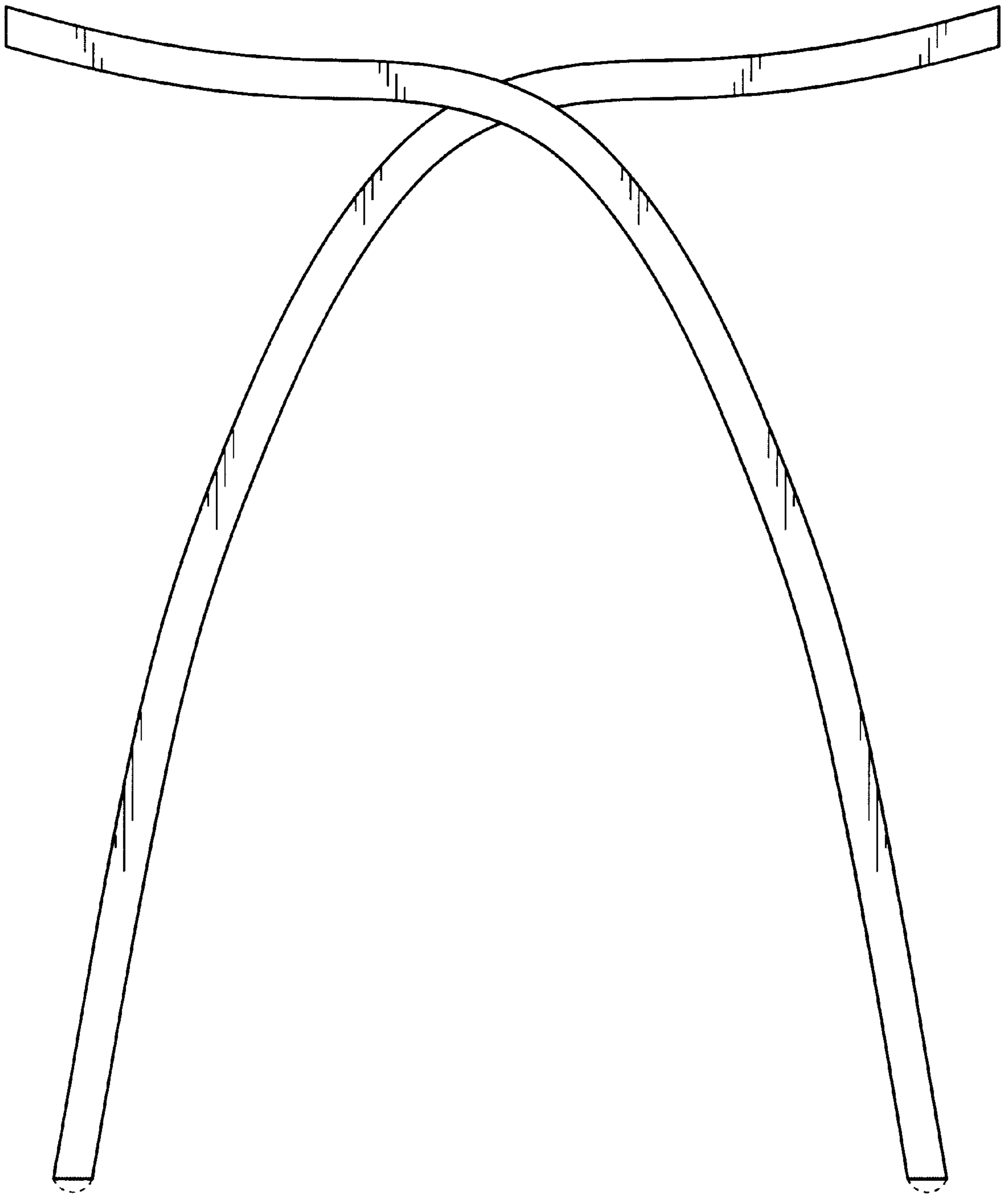

FIG. 10

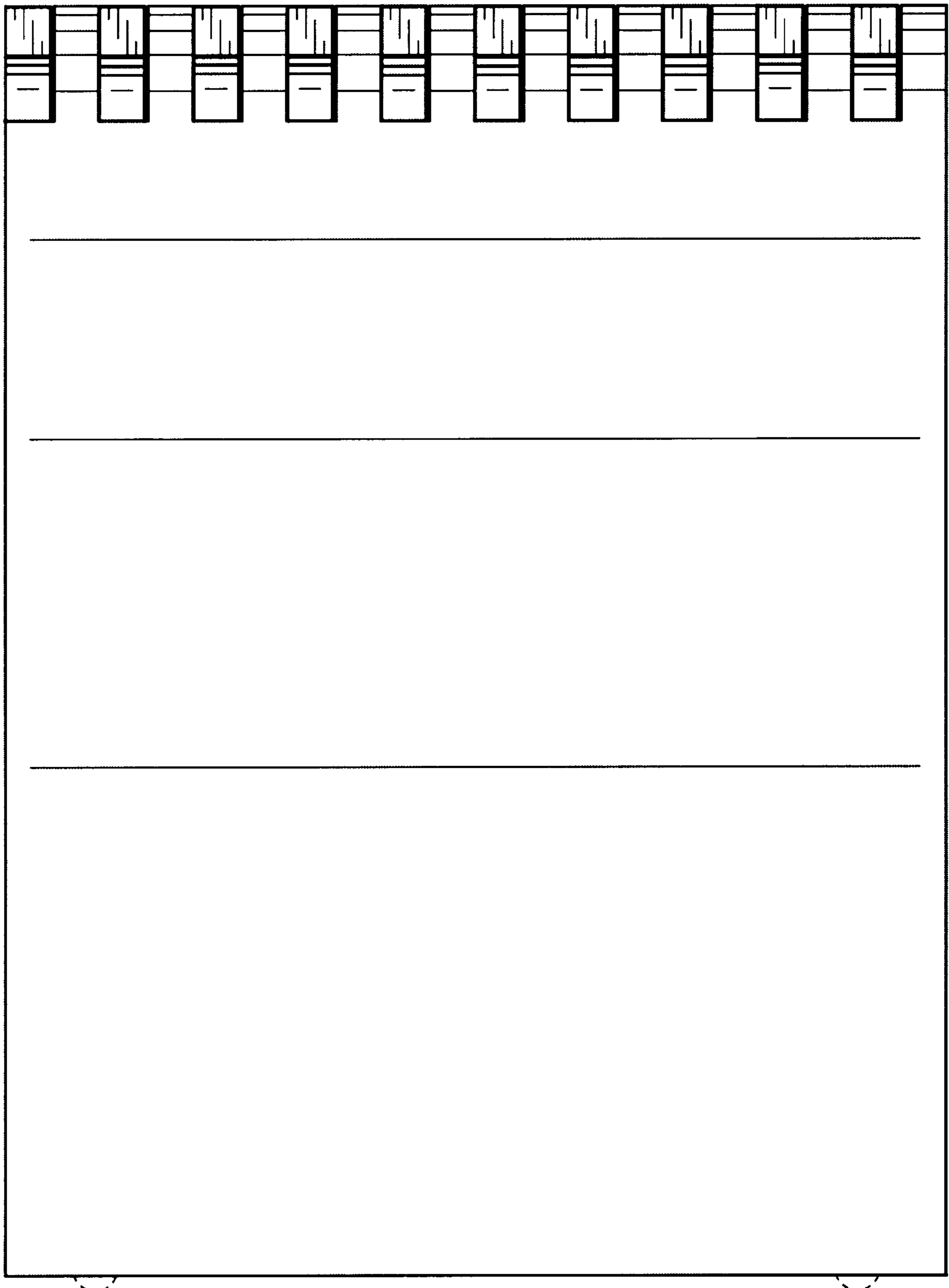

FIG. 11

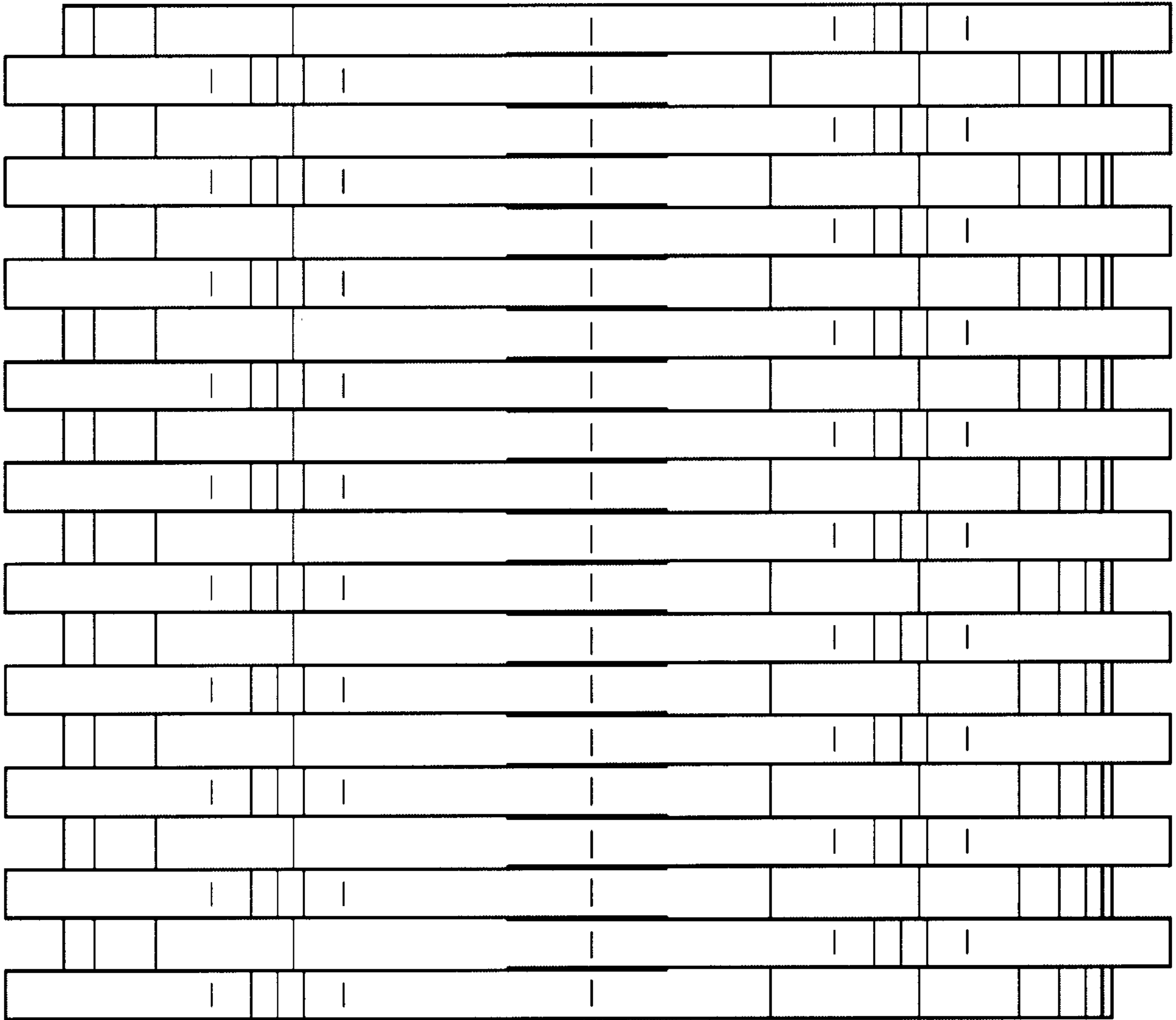

FIG. 12

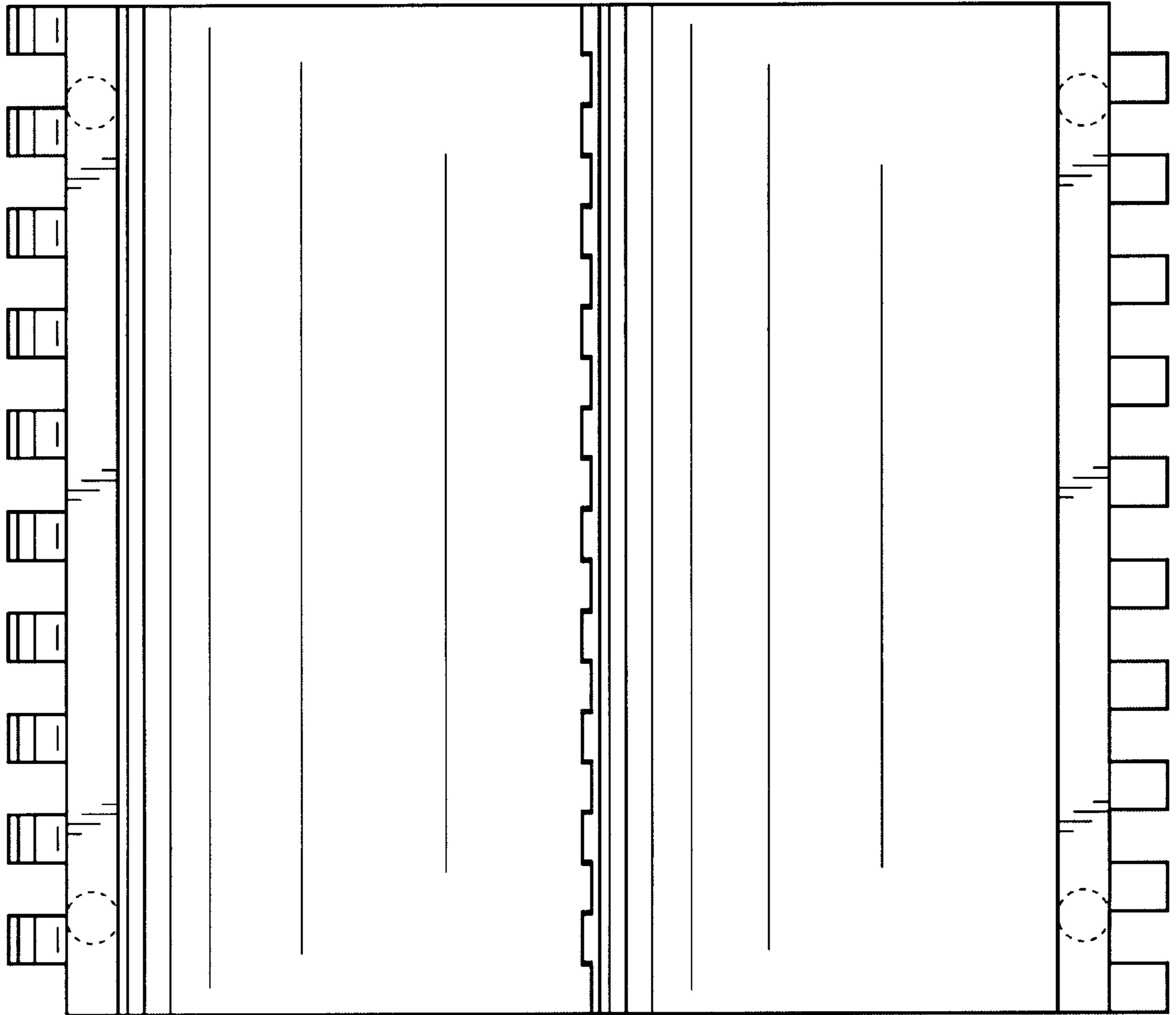

FIG. 13