



US00D438008S

(12) **United States Design Patent**  
**Snider**

(10) **Patent No.:** **US D438,008 S**

(45) **Date of Patent:** **\*\* Feb. 27, 2001**

(54) **ARTICLE CARRIER**

(75) Inventor: **Gregory S. Snider**, Bel Air, MD (US)

(73) Assignee: **Black & Decker Inc.**, Newark, DE (US)

(\*\*) Term: **14 Years**

(21) Appl. No.: **29/117,729**

(22) Filed: **Jan. 31, 2000**

(51) **LOC (7) Cl.** ..... **03-01**

(52) **U.S. Cl.** ..... **D3/299; D3/303**

(58) **Field of Search** ..... D3/290, 299, 273,  
D3/283, 226, 228, 230; 224/901, 904, 914,  
236, 240; 150/134, 143; 206/576

(56) **References Cited**

**U.S. PATENT DOCUMENTS**

- D. 236,556 8/1975 Di Paola .
- D. 239,985 5/1976 Artz .
- D. 239,986 5/1976 Artz .
- D. 245,947 10/1977 Finley .
- D. 266,205 9/1982 Berman .
- D. 288,624 \* 3/1987 Hoard ..... D3/299
- D. 291,627 9/1987 Collins .
- D. 292,843 11/1987 Frezza .
- D. 306,654 3/1990 Brown .
- D. 323,937 \* 2/1992 Solomon ..... D3/299
- D. 333,913 \* 3/1993 Tuman ..... D3/285
- D. 348,776 7/1994 Anderson .
- D. 364,038 11/1995 Stanchin .

(List continued on next page.)

**FOREIGN PATENT DOCUMENTS**

- 81 12 879 10/1981 (DE) .
- 85 01 388 4/1985 (DE) .
- 87 05 604 6/1987 (DE) .
- 38 25 195 A1 4/1989 (DE) .
- 299 01 393
- U1 5/1999 (DE) .
- 0 348 694 B1 8/1995 (EP) .
- WO 93/02586 2/1993 (WO) .

**OTHER PUBLICATIONS**

- Camera Case.
- Nite Ize ® Pock-Its Utility Holster—Website Information (3 pages).
- Nite Ize ® Mini Pock-Its Utility Holster—Website Information (3 pages).

(List continued on next page.)

*Primary Examiner*—Raphael Barkai  
(74) *Attorney, Agent, or Firm*—Harness, Dickey & Pierce, P.L.C.

(57) **CLAIM**

The ornamental design for an article carrier, as shown and described.

**DESCRIPTION**

FIG. 1 is a front exterior perspective view of an article carrier, in accordance with the ornamental design, illustrated in its closed configuration;

FIG. 2 is a front view thereof;

FIG. 3 is a rear view thereof;

FIG. 4 is a side view thereof;

FIG. 5 is a top view thereof;

FIG. 6 is a bottom view thereof;

FIG. 7 is a front view similar to that of FIG. 2, but with the article carrier illustrated in its open configuration;

FIG. 8 is a front exterior perspective view of an alternate embodiment of an article carrier, in accordance with the ornamental design, illustrated in its closed configuration;

FIG. 9 is a front view thereof;

FIG. 10 is a rear view thereof;

FIG. 11 is a side view thereof;

FIG. 12 is a top view thereof;

FIG. 13 is a bottom view thereof; and,

FIG. 14 is a front view similar to that of FIG. 9, but with the alternate article carrier illustrated in its open configuration. The broken lines shown in FIGS. 7 and 14 are for illustrative purposes only and form no part of the claimed design.

**1 Claim, 8 Drawing Sheets**

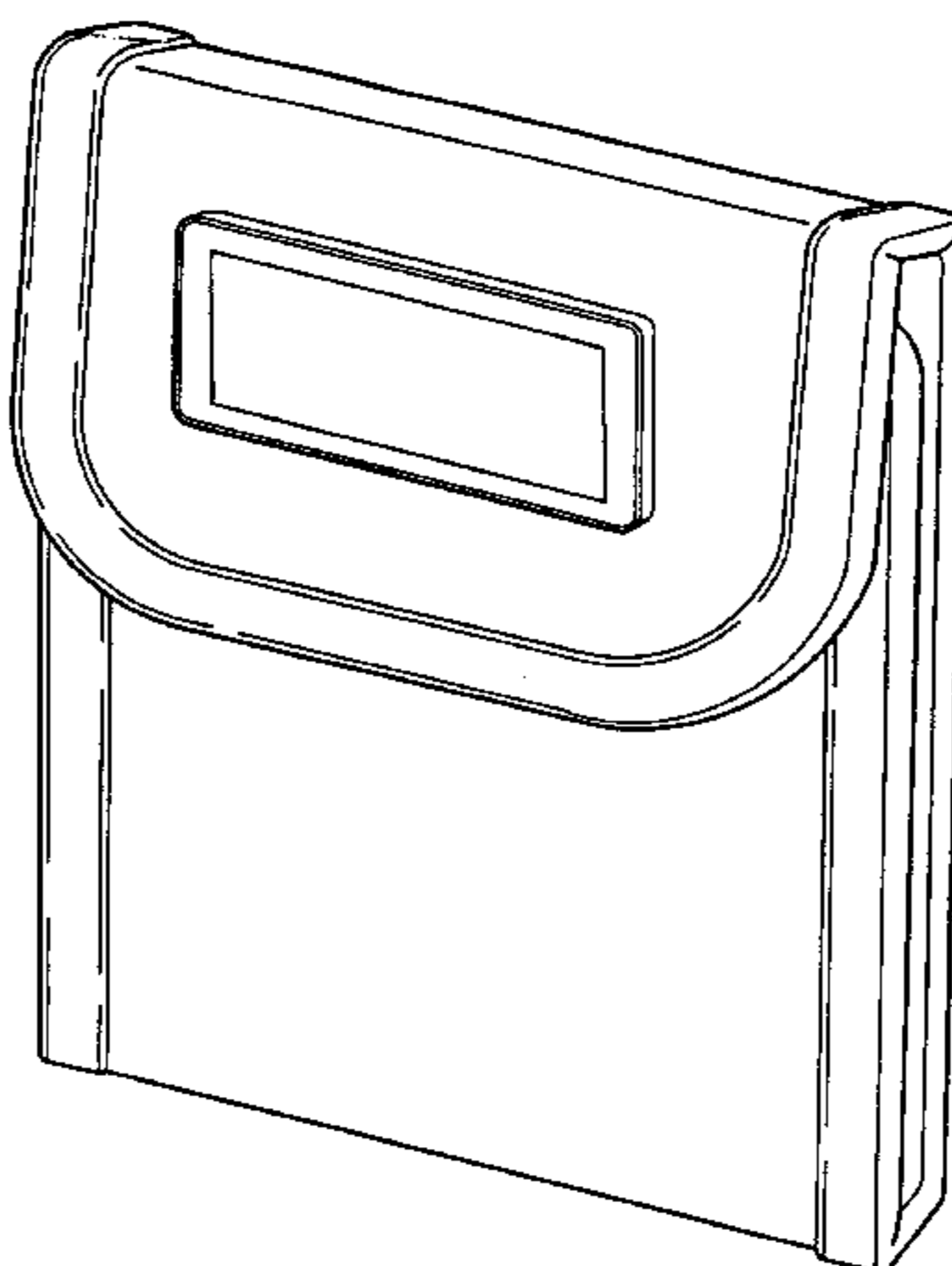

U.S. PATENT DOCUMENTS

D. 368,581 4/1996 Cincotta .  
D. 375,629 \* 11/1996 Chen ..... D3/283  
D. 378,633 4/1997 Granito .  
D. 384,810 10/1997 Kopel .  
D. 387,906 \* 12/1997 Petty ..... D3/285  
1,506,926 9/1924 Gunter .  
2,413,580 12/1946 Perry .  
3,749,233 7/1973 McCormick, Jr. .  
3,949,916 4/1976 Yount .  
3,955,609 5/1976 Siegel .  
4,047,650 9/1977 Domingos .  
4,101,025 7/1978 Jordan .  
4,648,505 3/1987 Belmondo .  
4,773,535 9/1988 Cook .  
4,921,153 5/1990 Smith .

5,002,401 3/1991 Blackman .  
5,139,143 8/1992 Pond .  
5,423,404 6/1995 Shaw .  
5,711,469 1/1998 Gormley et al. .

OTHER PUBLICATIONS

Nite-Ize Mini Pock-Its Utility Holster and packaging (6 photographs).  
Nite Ize Pock-Its and packaging (7 photographs).  
Duluth Tool Chisel Roll Cotton—Website Information (1 page).  
Duluth Wrench Roll—Website Information (1 page).  
Duluth Cotton Wrench Roll; DuckWear Tool Roll; and Tool/Chisel Roll—Duluth Trading Co. (catalog p. 34).

\* cited by examiner

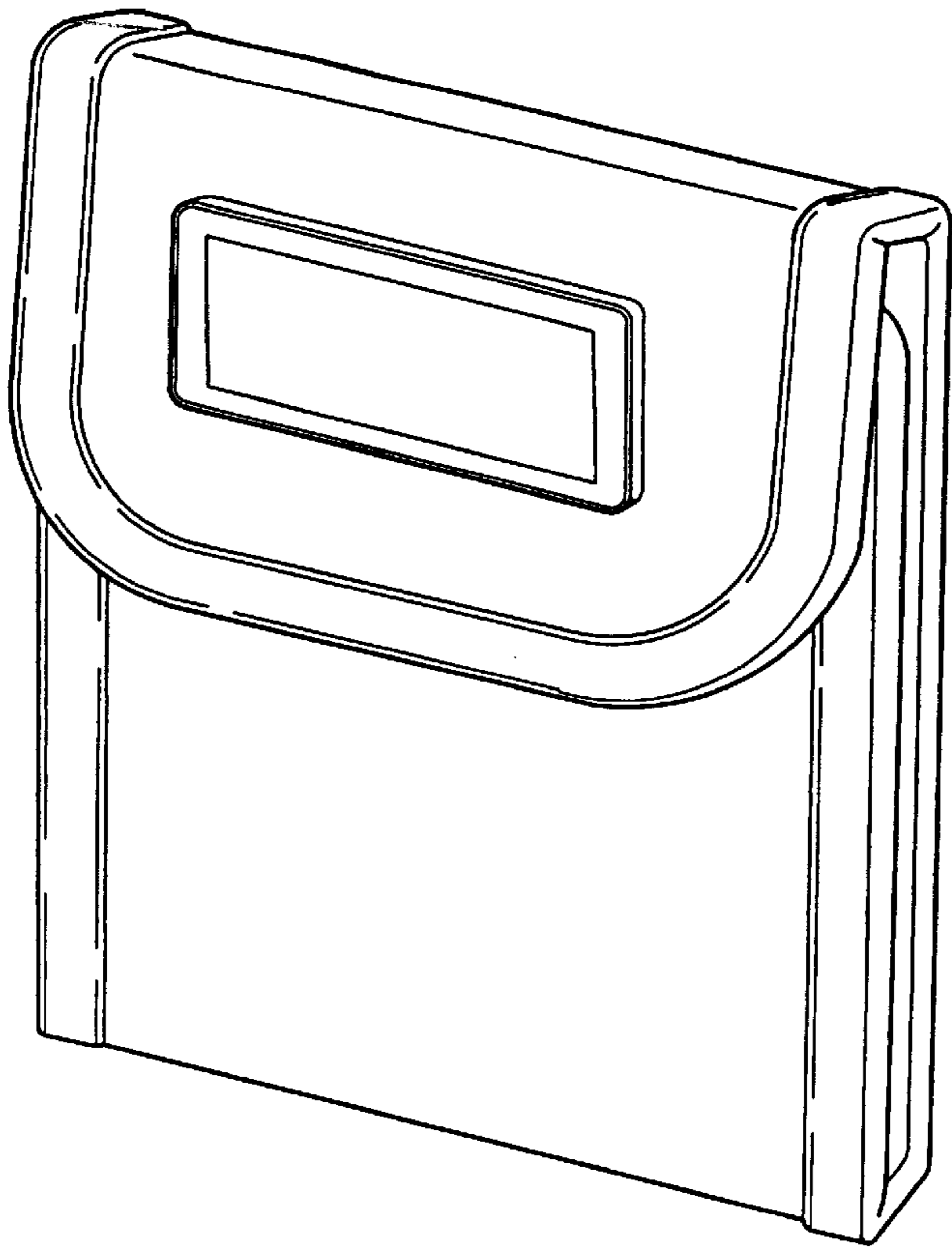

Figure - 1

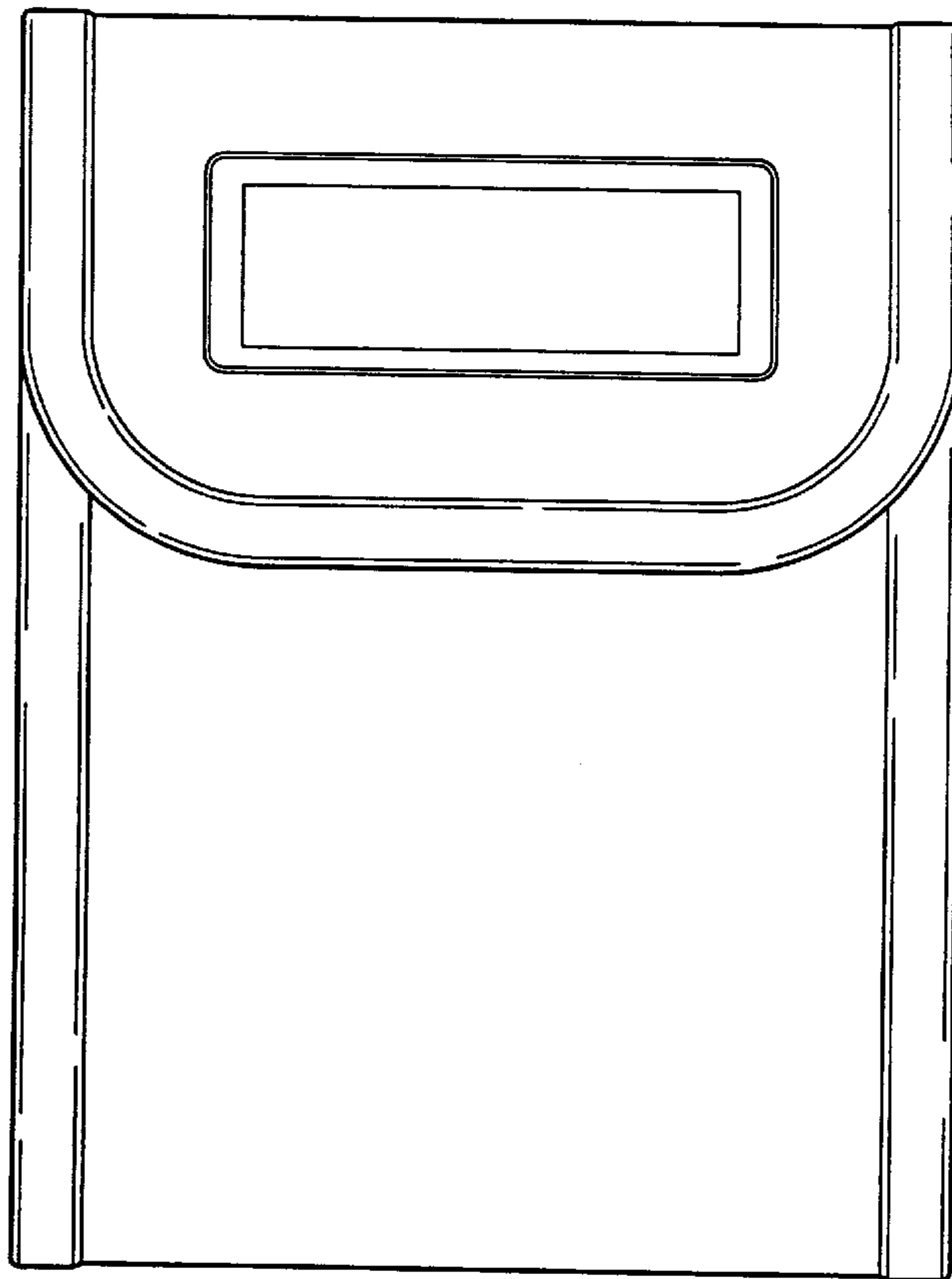

Figure - 2

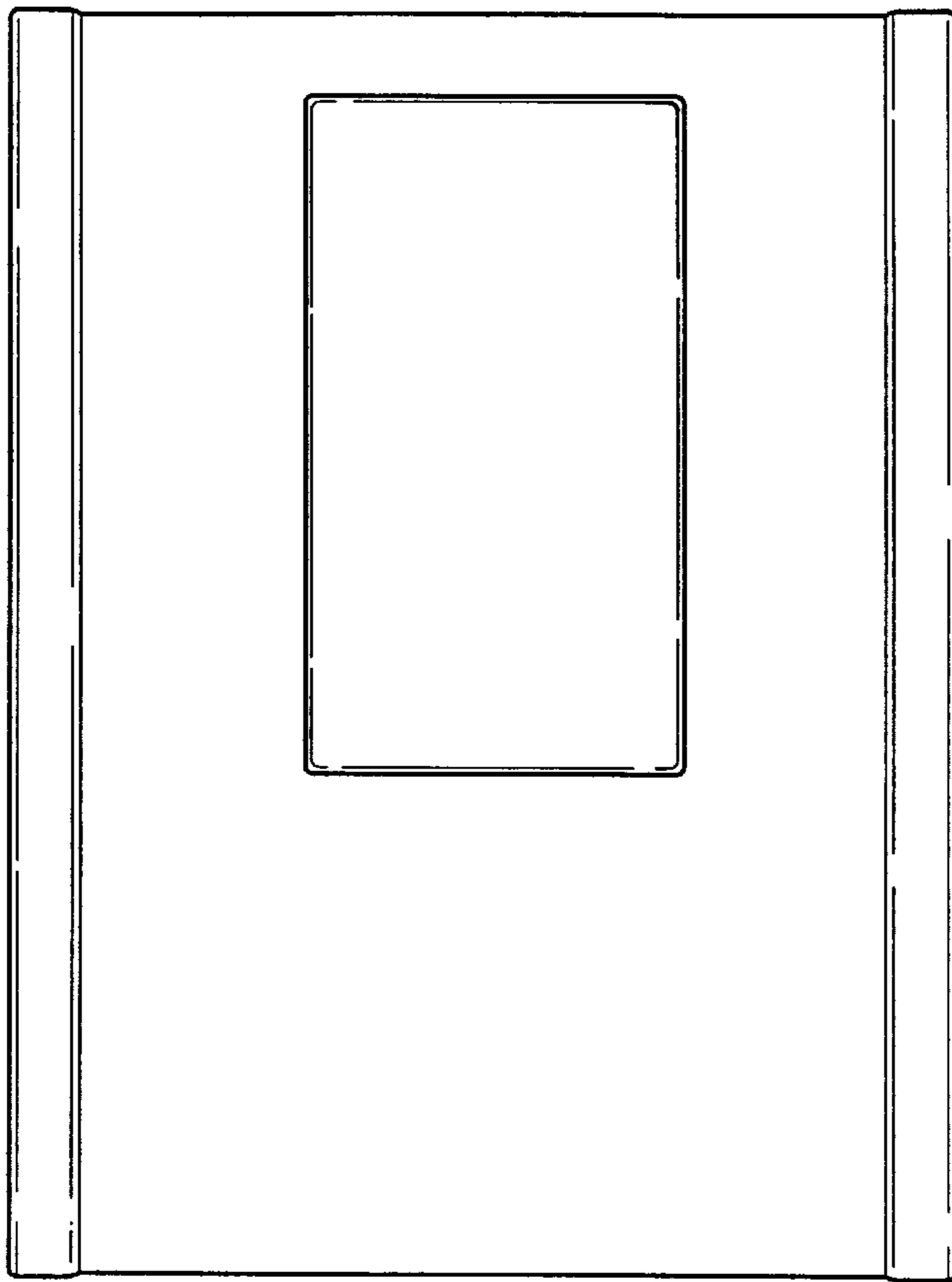

Figure - 3



Figure - 4

Figure - 5

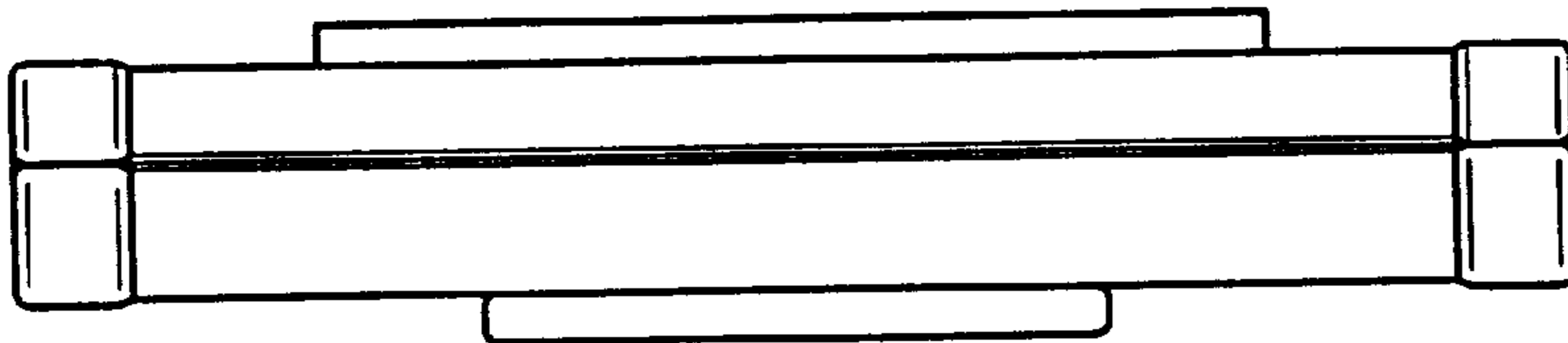
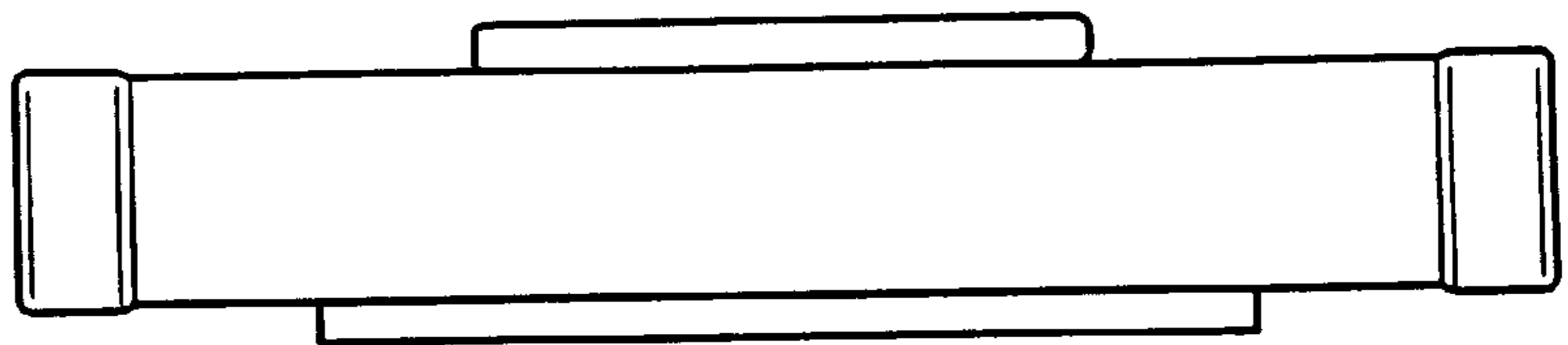

Figure - 6

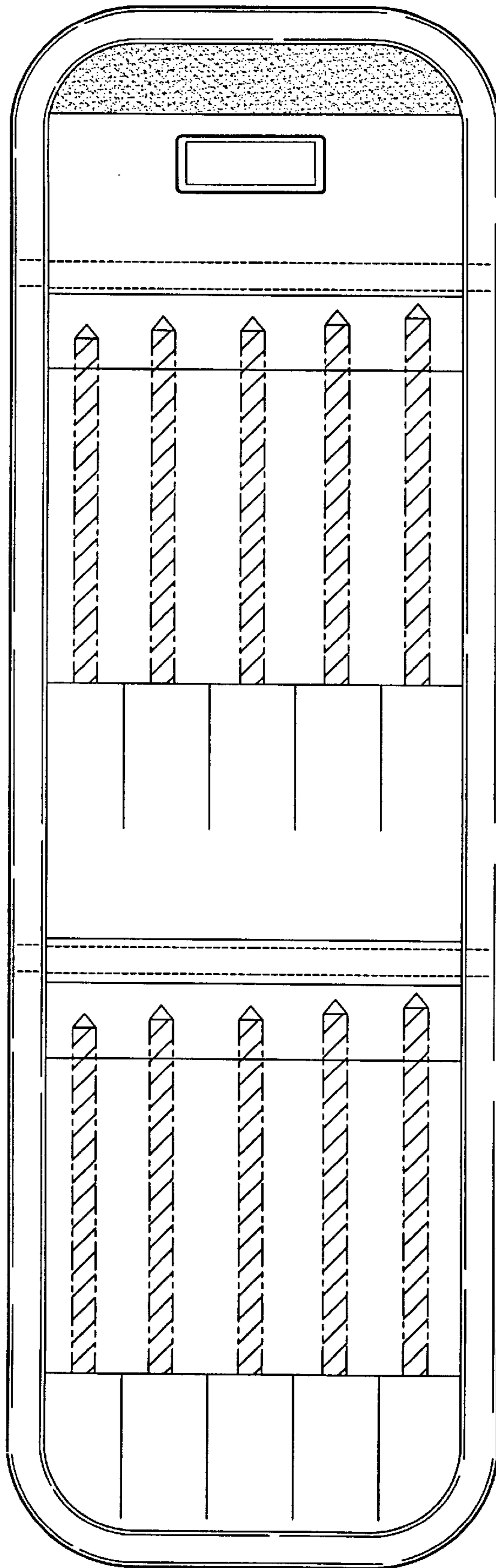

Figure - 7

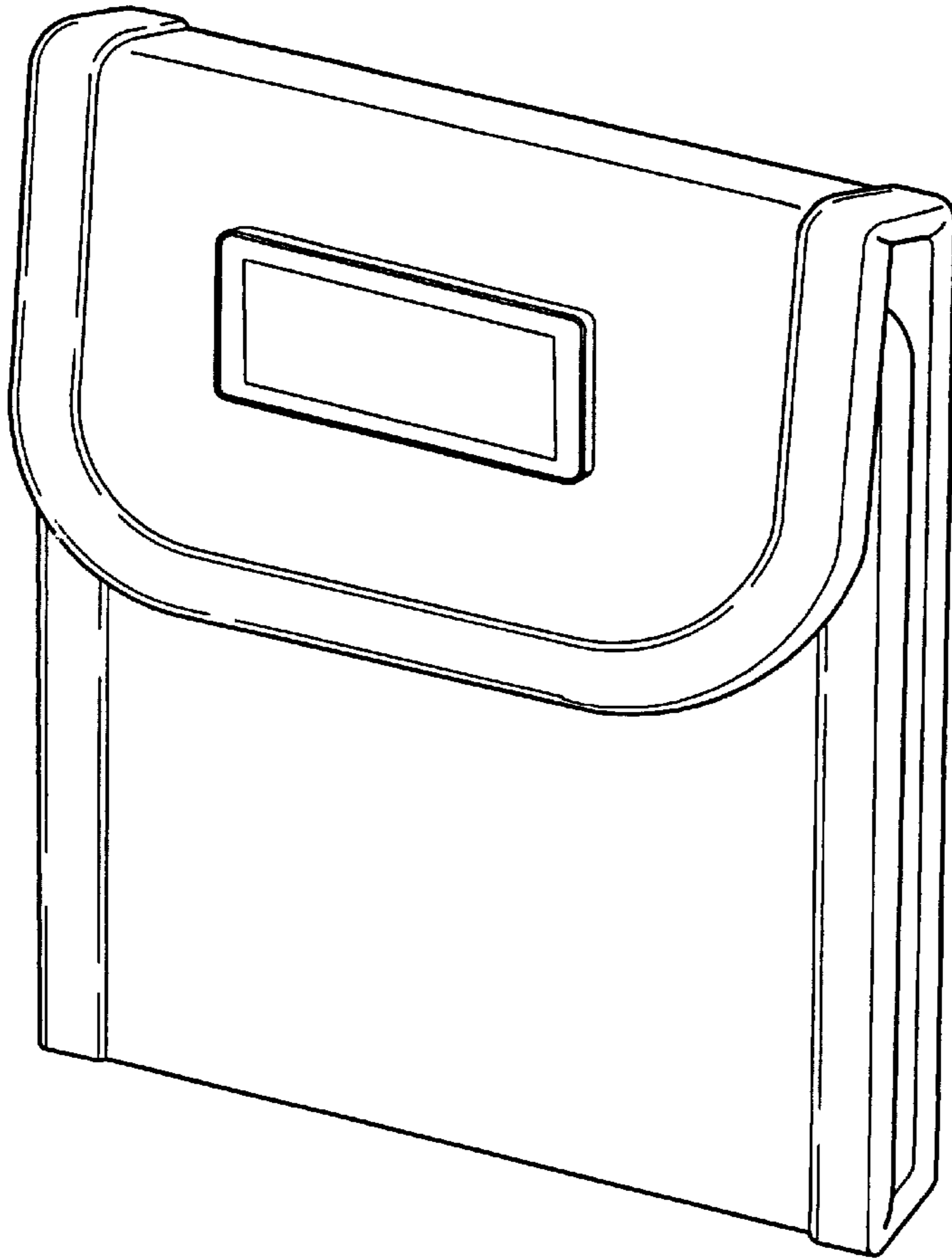

Figure - 8

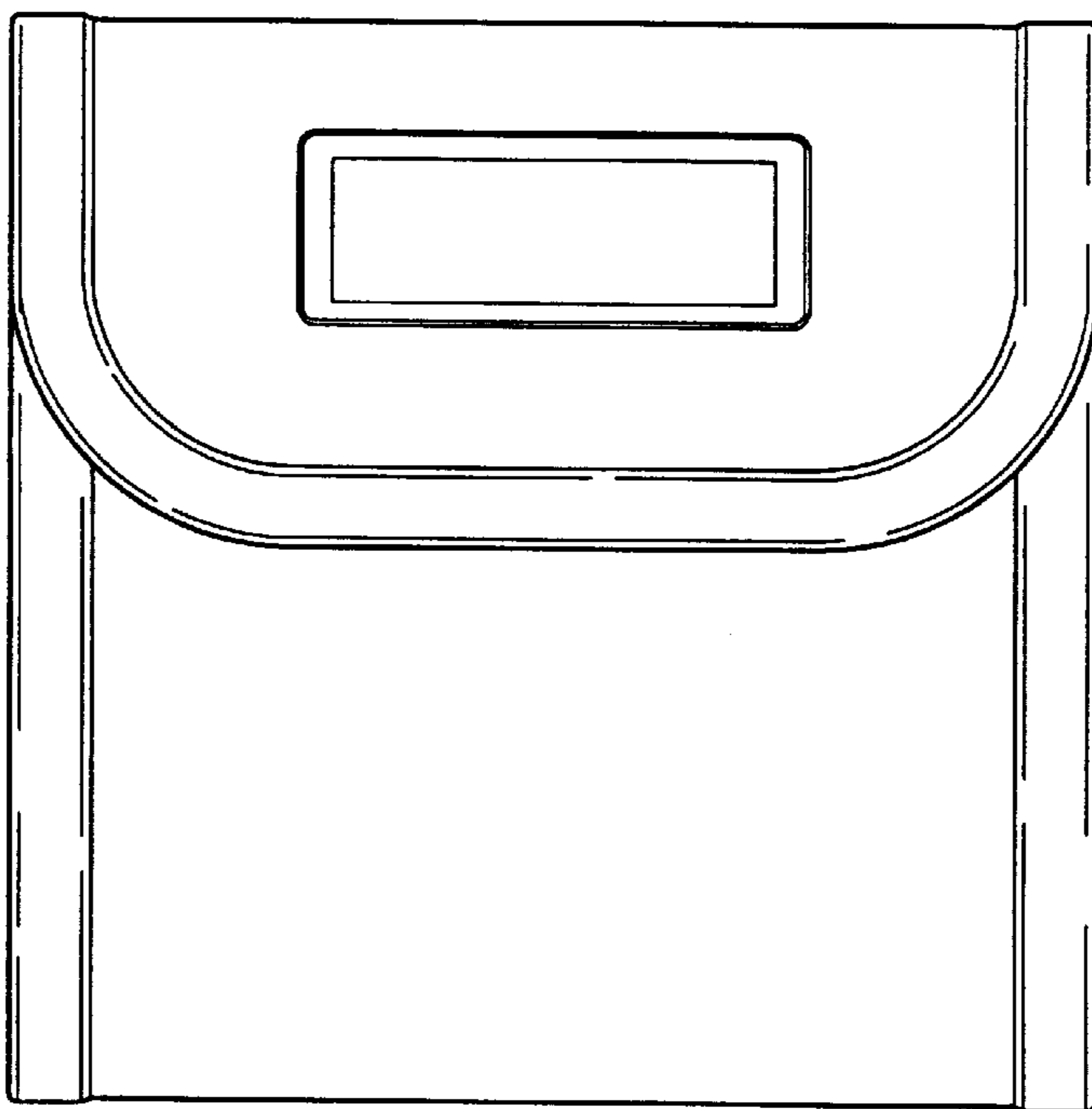

Figure - 9

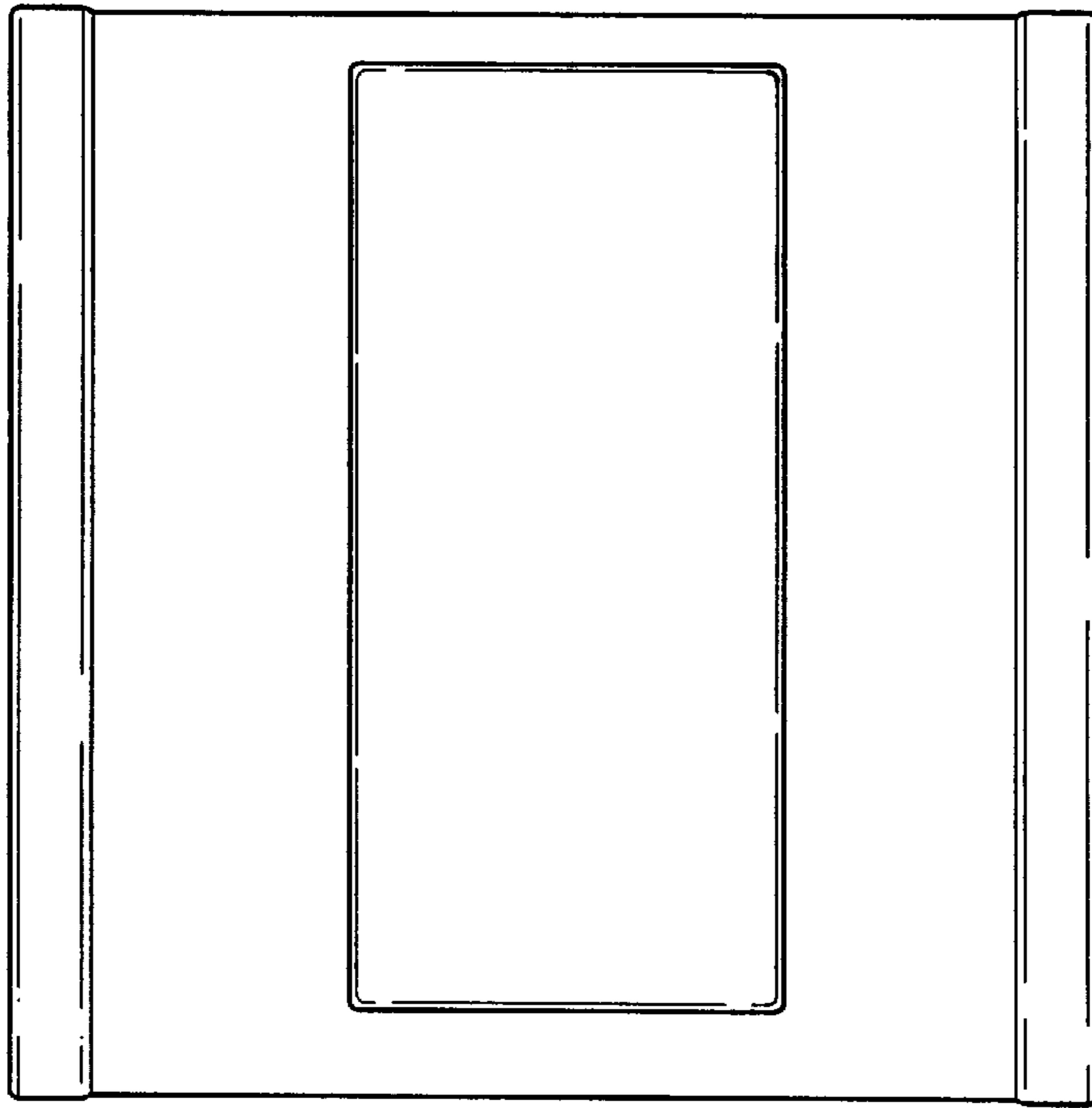

Figure - 10

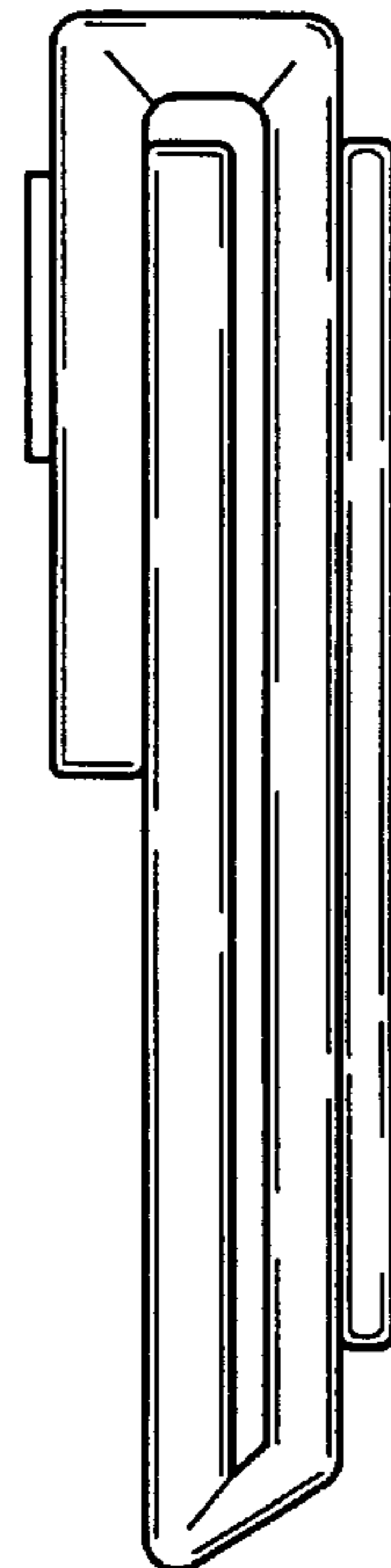

Figure - 11



Figure - 12

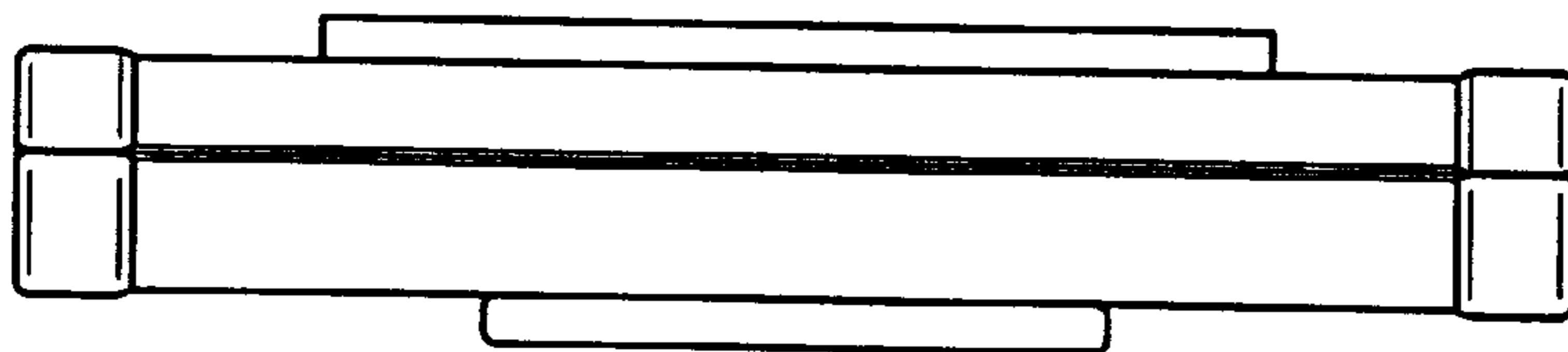
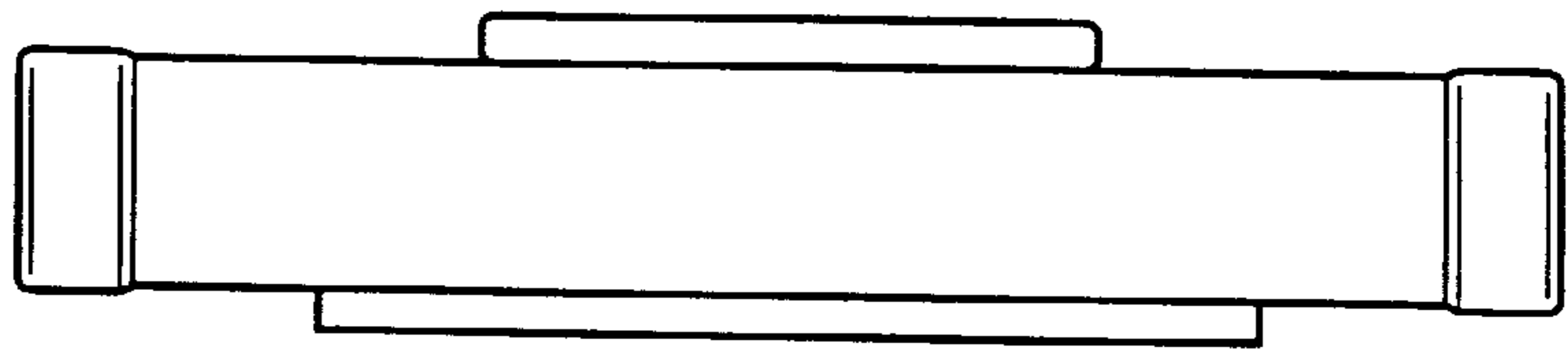

Figure - 13

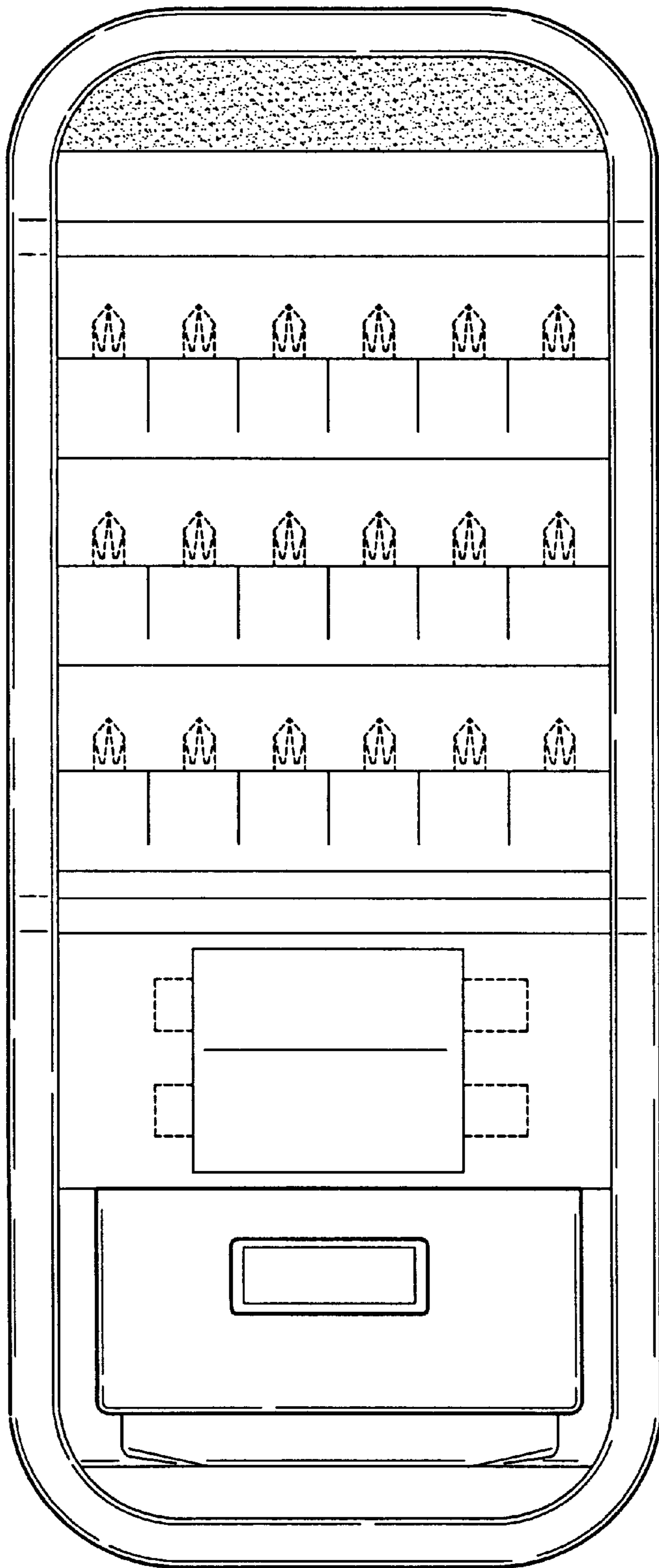

Figure - 14