



US00D438007S

(12) **United States Design Patent**
Holland et al.

(10) **Patent No.:** **US D438,007 S**

(45) **Date of Patent:** **** Feb. 27, 2001**

(54) **ARTICLE CARRIER**

(75) Inventors: **Matthew J. Holland**, Baltimore; **Brian N. Kagen**, Owings Mills, both of MD (US)

(73) Assignee: **Black & Decker Inc.**, Newark, DE (US)

(**) Term: **14 Years**

(21) Appl. No.: **29/103,170**

(22) Filed: **Apr. 9, 1999**

(51) **LOC (7) Cl.** **03-01**

(52) **U.S. Cl.** **D3/299; D3/303**

(58) **Field of Search** D3/290, 299, 273, D3/283, 226, 228; 224/901, 904, 914, 236, 240; 150/134, 143; 206/576

(56) **References Cited**

U.S. PATENT DOCUMENTS

- D. 236,556 8/1975 Di Paola .
- D. 239,985 5/1976 Artz .
- D. 239,986 5/1976 Artz .
- D. 245,947 10/1977 Finley .
- D. 266,205 9/1982 Berman .
- D. 288,624 * 3/1987 Hoard D3/299
- D. 291,627 9/1987 Collins .
- D. 292,843 11/1987 Frezza .
- D. 306,654 3/1990 Brown .
- D. 323,937 * 2/1992 Solomon D3/299

(List continued on next page.)

FOREIGN PATENT DOCUMENTS

- 81 12 879 10/1981 (DE) .
- 85 01 388 4/1985 (DE) .
- 87 05 604 6/1987 (DE) .
- 38 25 195 A1 4/1989 (DE) .
- 299 01 393
- U1 5/1999 (DE) .
- 0 348 694 B1 8/1995 (EP) .
- WO 93/02586 2/1993 (WO) .

OTHER PUBLICATIONS

- Camera Case.
- Flash Light Case for Mini Maglight.
- Nite Ize ® Pock-Its Utility Holster—Website Information (3 pages) Undated.
- Nite Ize ® Mini Pock-Its Utility Holster—Website Information (3 pages) Undated.
- Nite-Ize Mini Pock-Its Utility Holster and packaging (6 photographs) Undated.
- Nite Ize Pock-Its and packaging (7 photographs) Undated.
- Duluth Tool Chisel Roll Cotton—Website Information (1 page) Undated.
- Duluth Wrench Roll—Website Information (1 page) Undated.
- Duluth Cotton Wrench Roll; DuckWear Tool Roll; and Tool/Chisel Roll—Duluth Trading Co. (catalog p. 34) Undated.

Primary Examiner—Philip S. Hyder

(74) *Attorney, Agent, or Firm*—Harness, Dickey & Pierce, P.L.C.

(57) **CLAIM**

The ornamental design for an article carrier, as shown and described.

DESCRIPTION

FIG. 1 is a front exterior perspective view of an article carrier, in accordance with the ornamental design, illustrated in its closed configuration;

FIG. 2 is a rear exterior perspective view thereof;

FIG. 3 is a front view thereof;

FIG. 4 is a rear view thereof;

FIG. 5 is a top view thereof;

FIG. 6 is a bottom view thereof;

FIG. 7 is a side view thereof; and,

FIG. 8 is a front perspective view similar to that of FIG. 1, but with the article carrier illustrated in its open configuration.

1 Claim, 4 Drawing Sheets

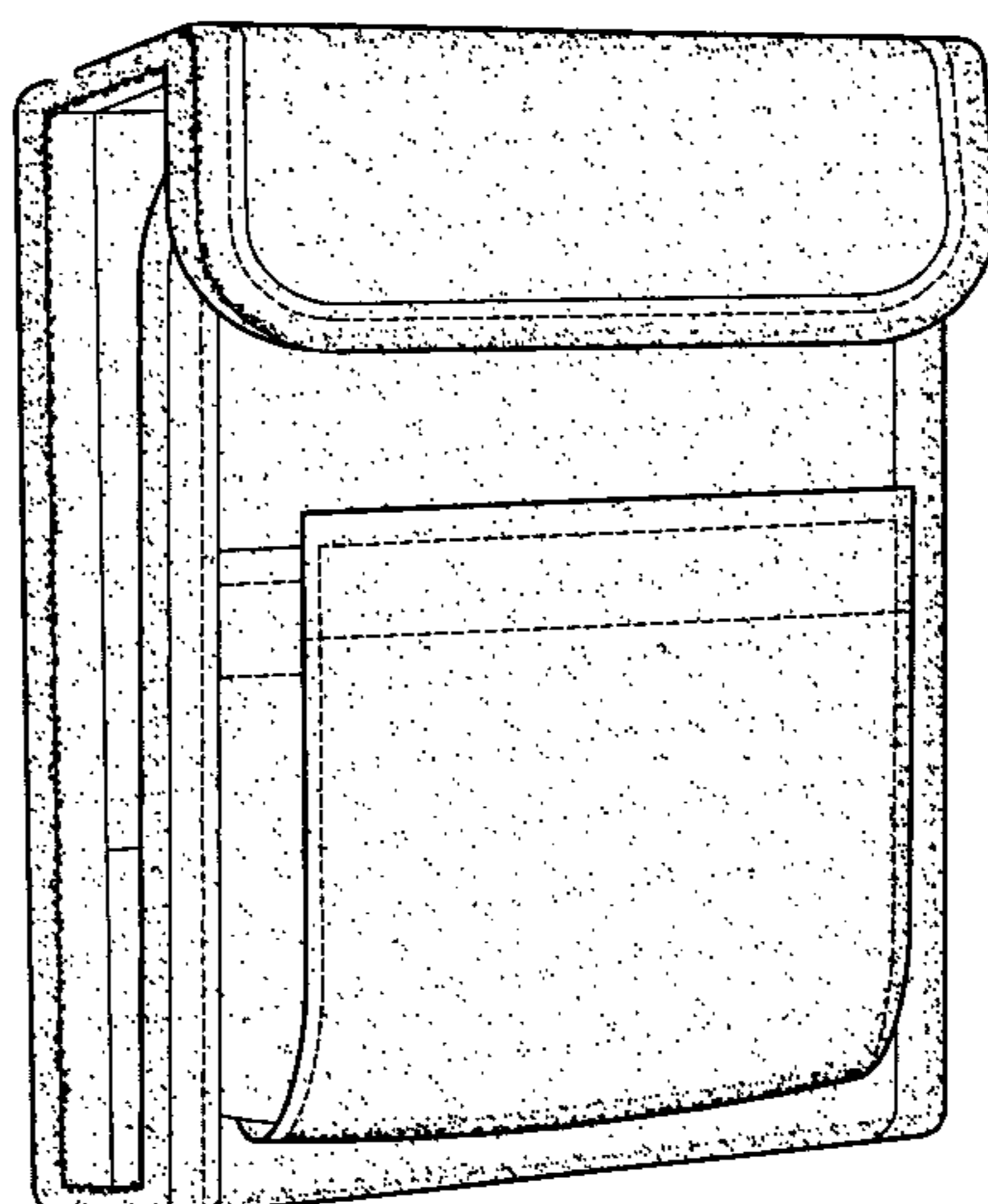

US D438,007 S

Page 2

| U.S. PATENT DOCUMENTS | | | |
|-----------------------|-----------|----------------|------------------------------|
| | | 3,949,916 | 4/1976 Yount . |
| | | 3,955,609 | 5/1976 Siegel . |
| | | 4,047,650 | 9/1977 Domingos . |
| | | 4,101,025 | 7/1978 Jordan 206/377 |
| | | 4,648,505 | 3/1987 Belmondo . |
| | | 4,773,535 | 9/1988 Cook 206/273 |
| | | 4,921,153 | 5/1990 Smith 224/253 |
| | | 5,002,401 | 3/1991 Blackman 383/38 |
| | | 5,139,143 | 8/1992 Pond 206/373 |
| | | 5,423,404 | 6/1995 Shaw 190/102 |
| D. 333,913 | * 3/1993 | Tuman | D3/285 |
| D. 348,776 | 7/1994 | Anderson | D3/226 |
| D. 364,038 | 11/1995 | Stanchin | D3/226 |
| D. 368,581 | 4/1996 | Cincotta | D3/218 |
| D. 375,629 | * 11/1996 | Chen | D3/283 |
| D. 378,633 | 4/1997 | Granito | D3/228 |
| D. 384,810 | 10/1997 | Kopel | D3/226 |
| D. 387,906 | * 12/1997 | Petty | D3/285 |
| 1,506,926 | 9/1924 | Gunter . | |
| 2,413,580 | 12/1946 | Perry . | |
| 3,749,233 | 7/1973 | McCormick . | |

* cited by examiner

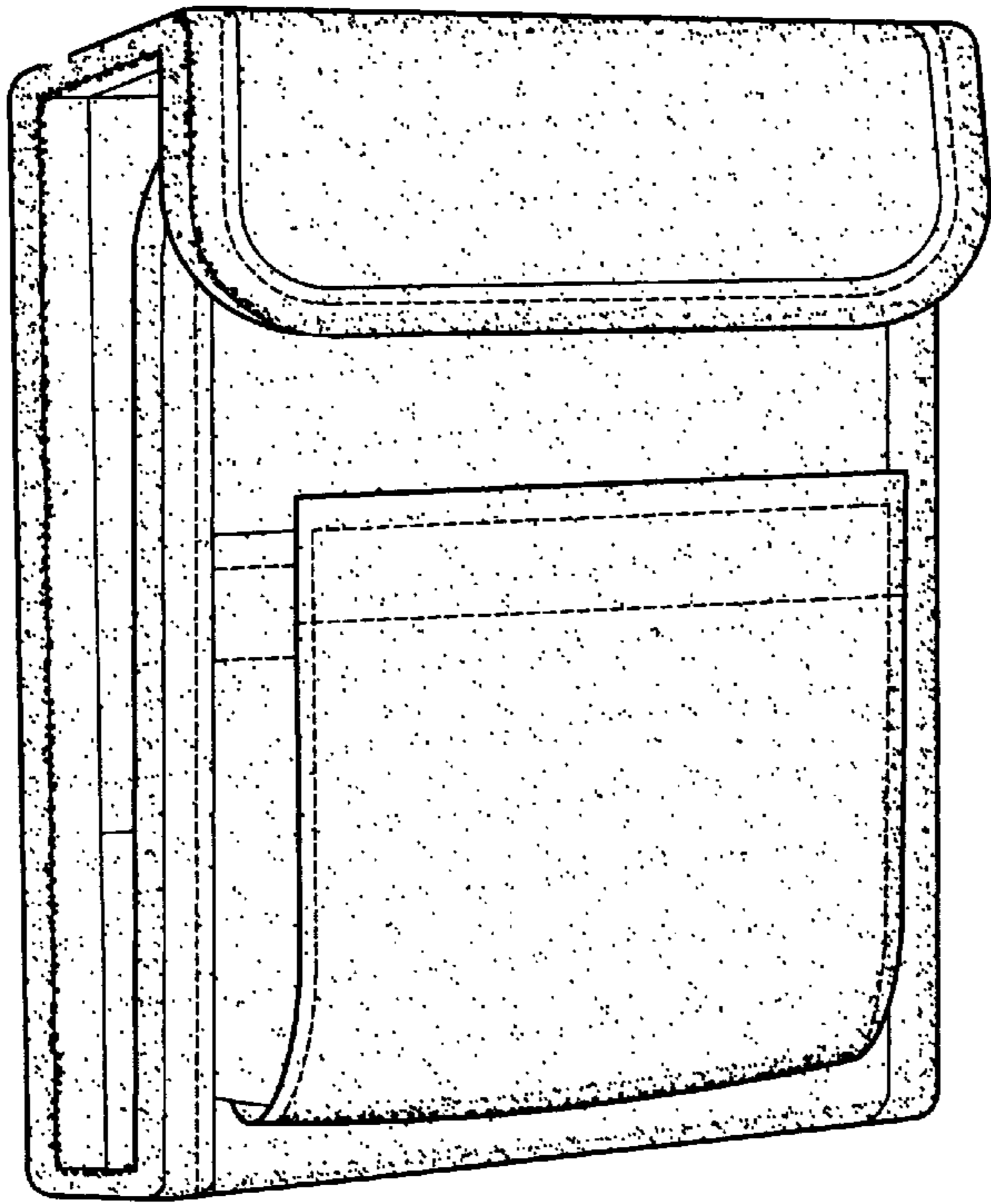

Fig-1

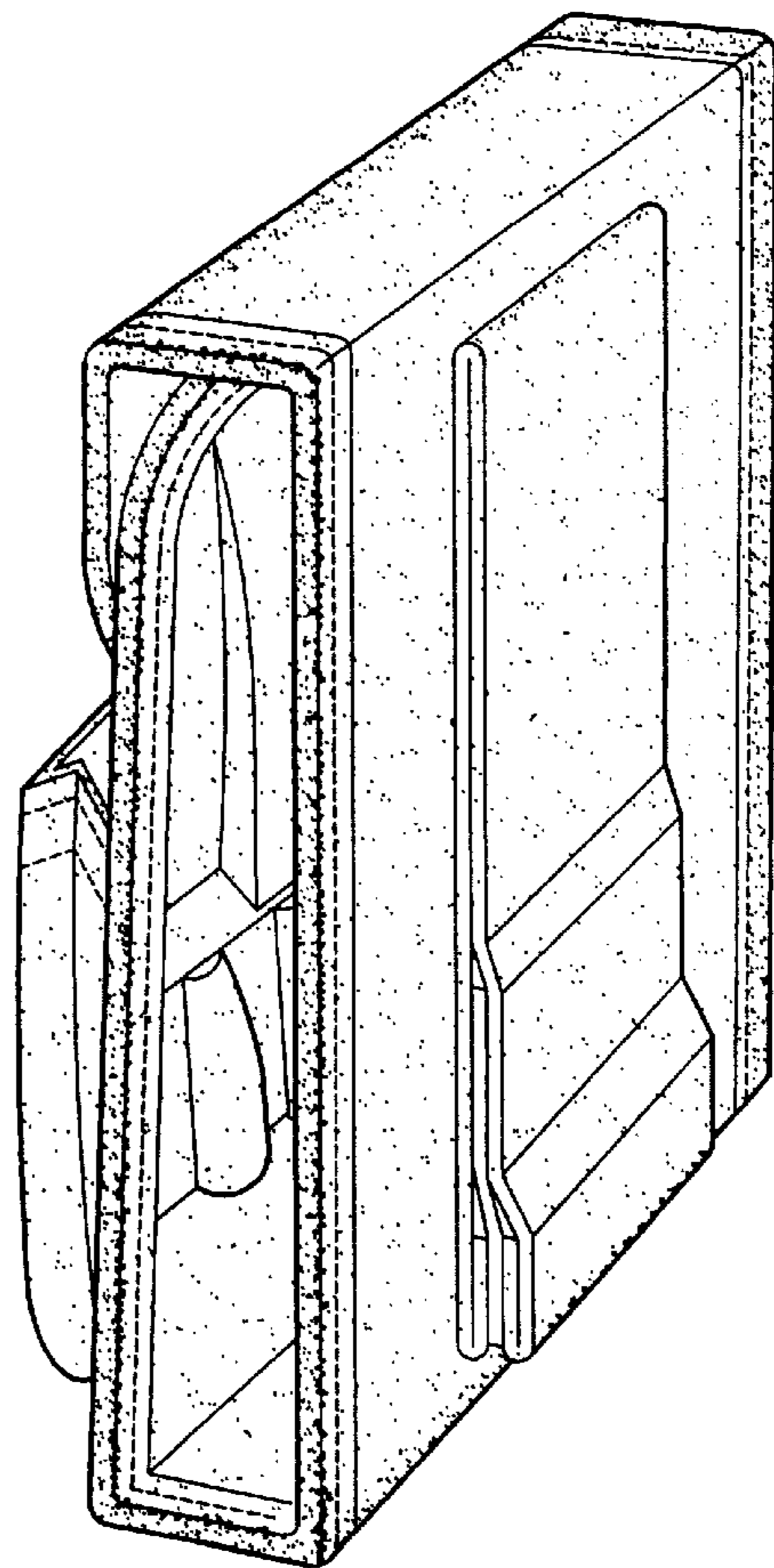

Fig-2

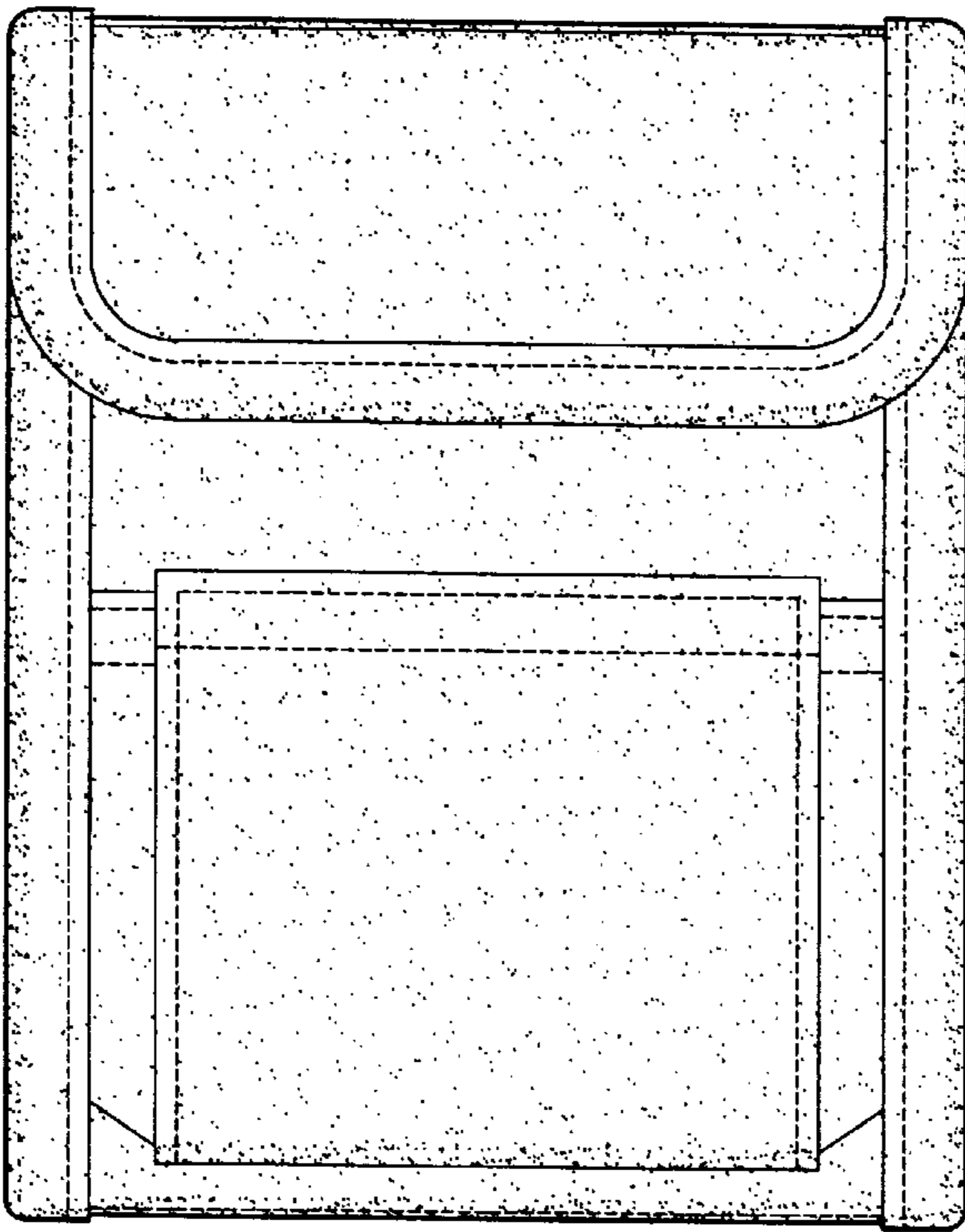

Fig-3

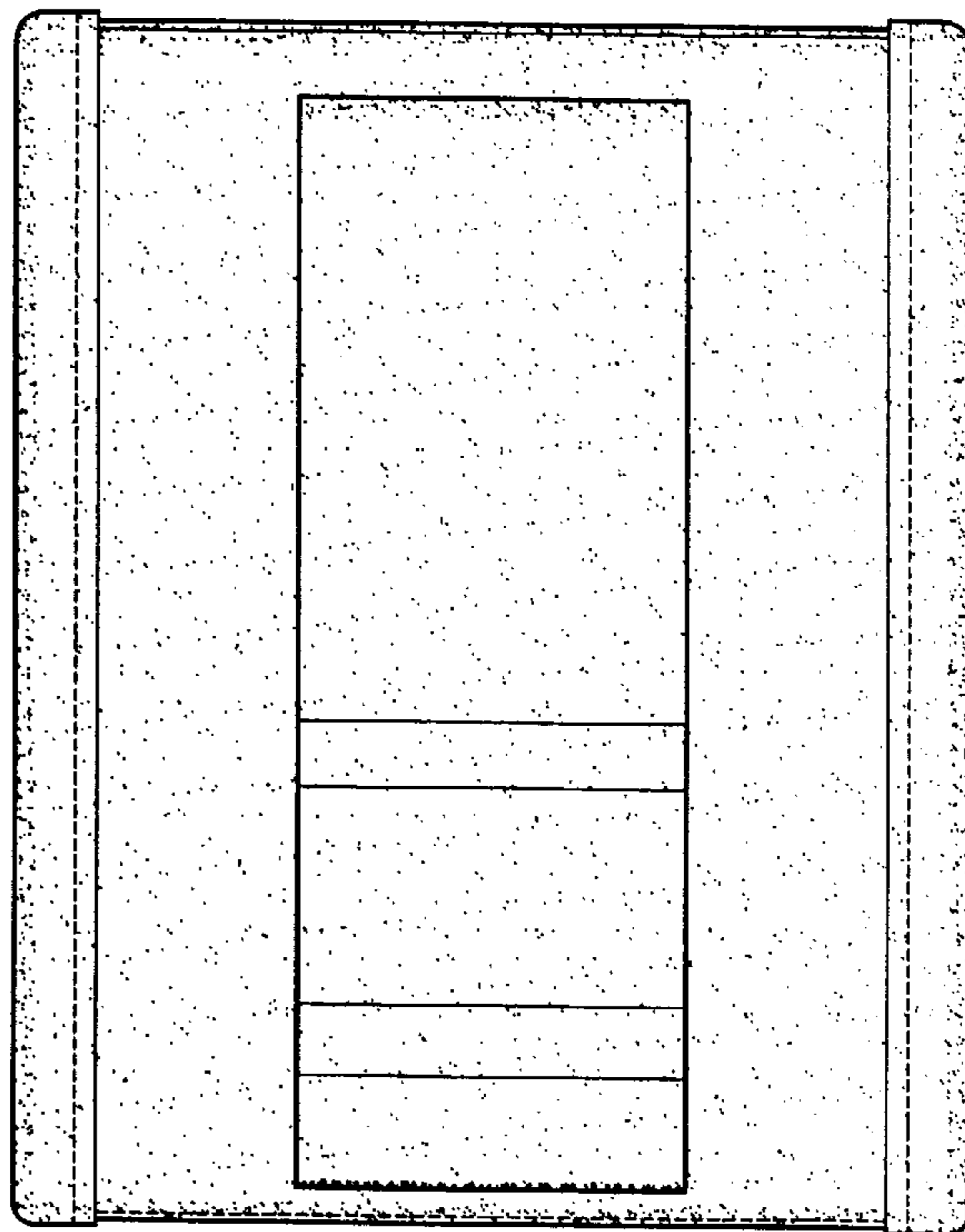

Fig-4

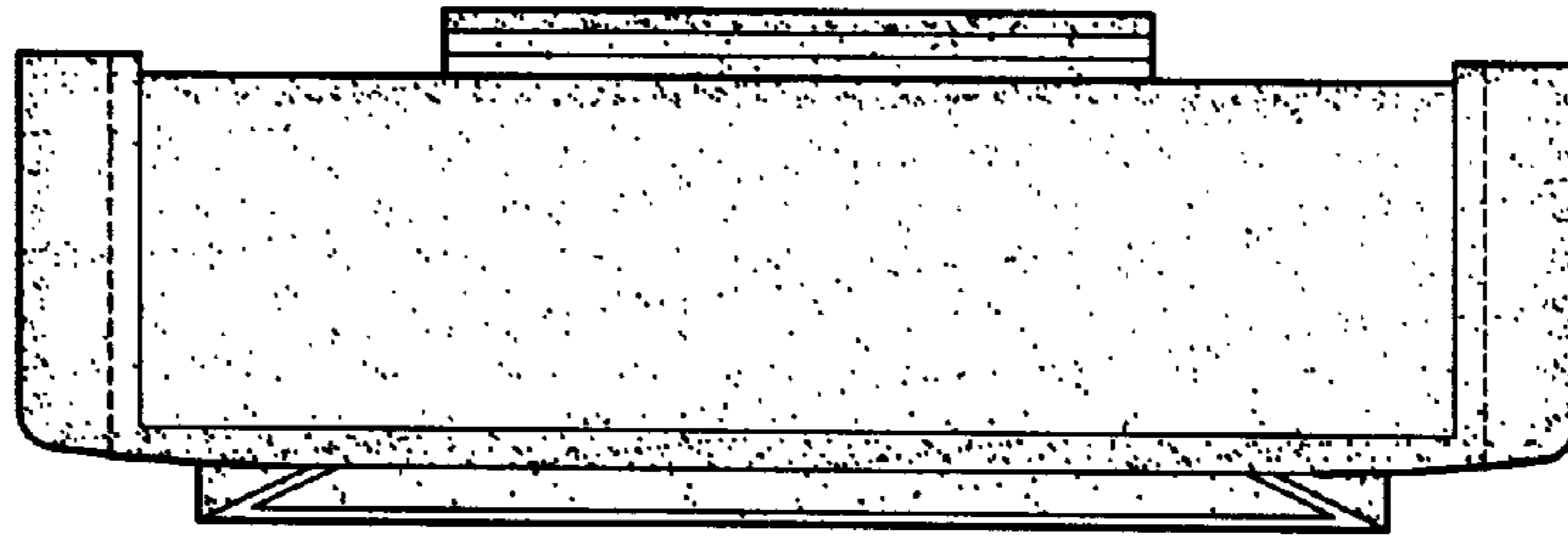

Fig-5

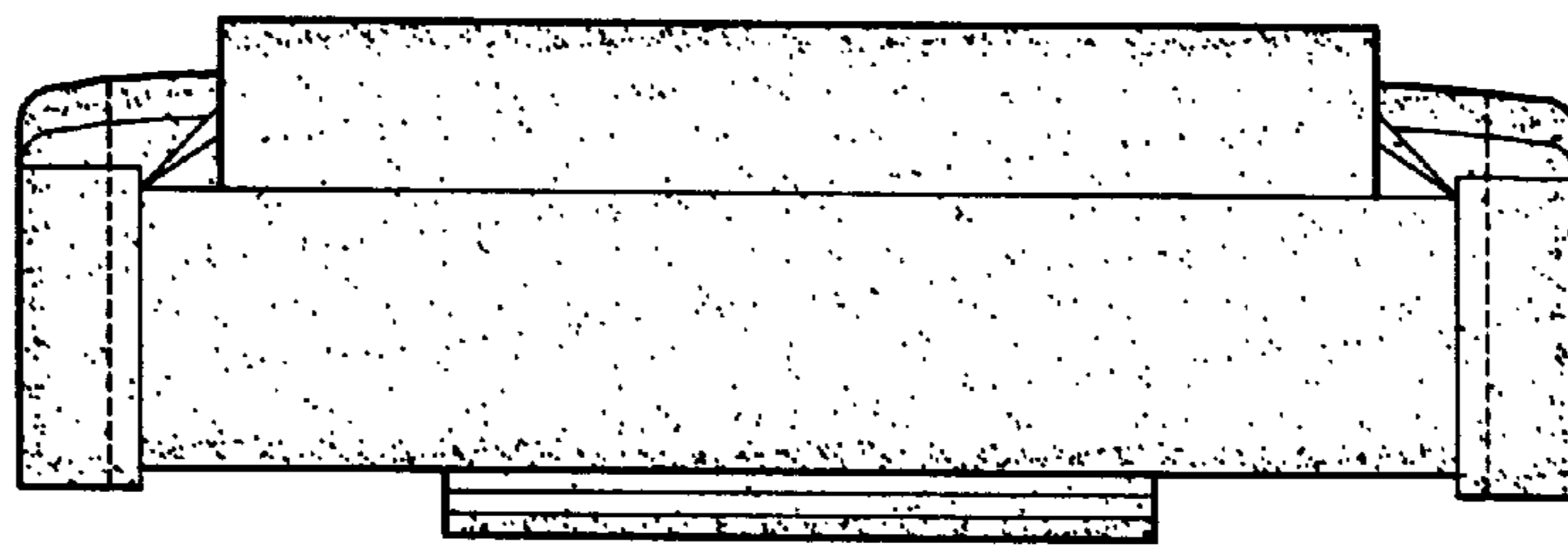

Fig-6

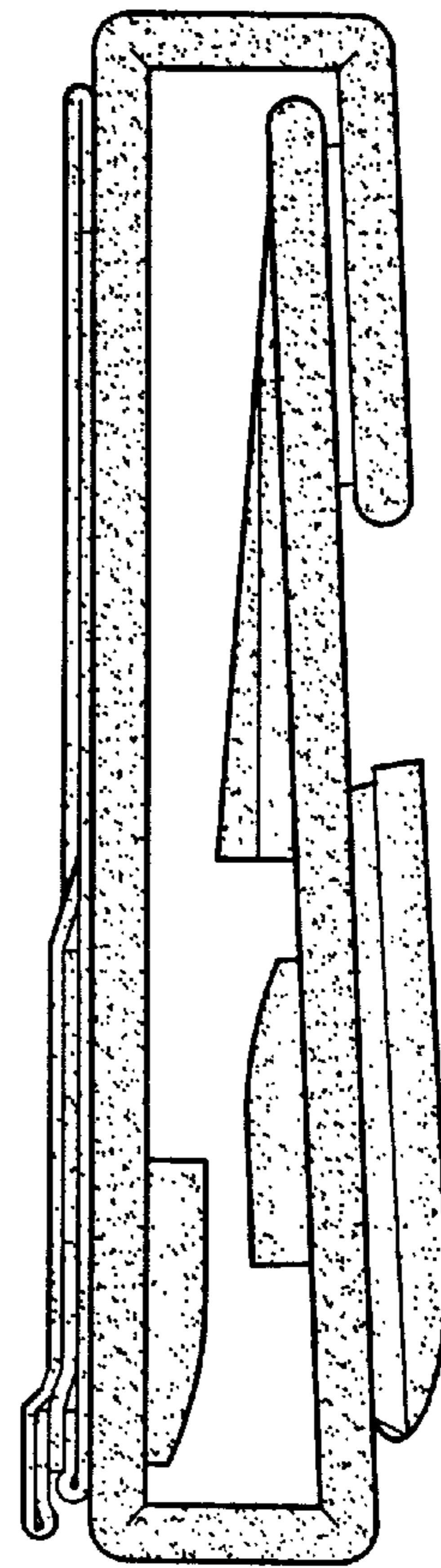
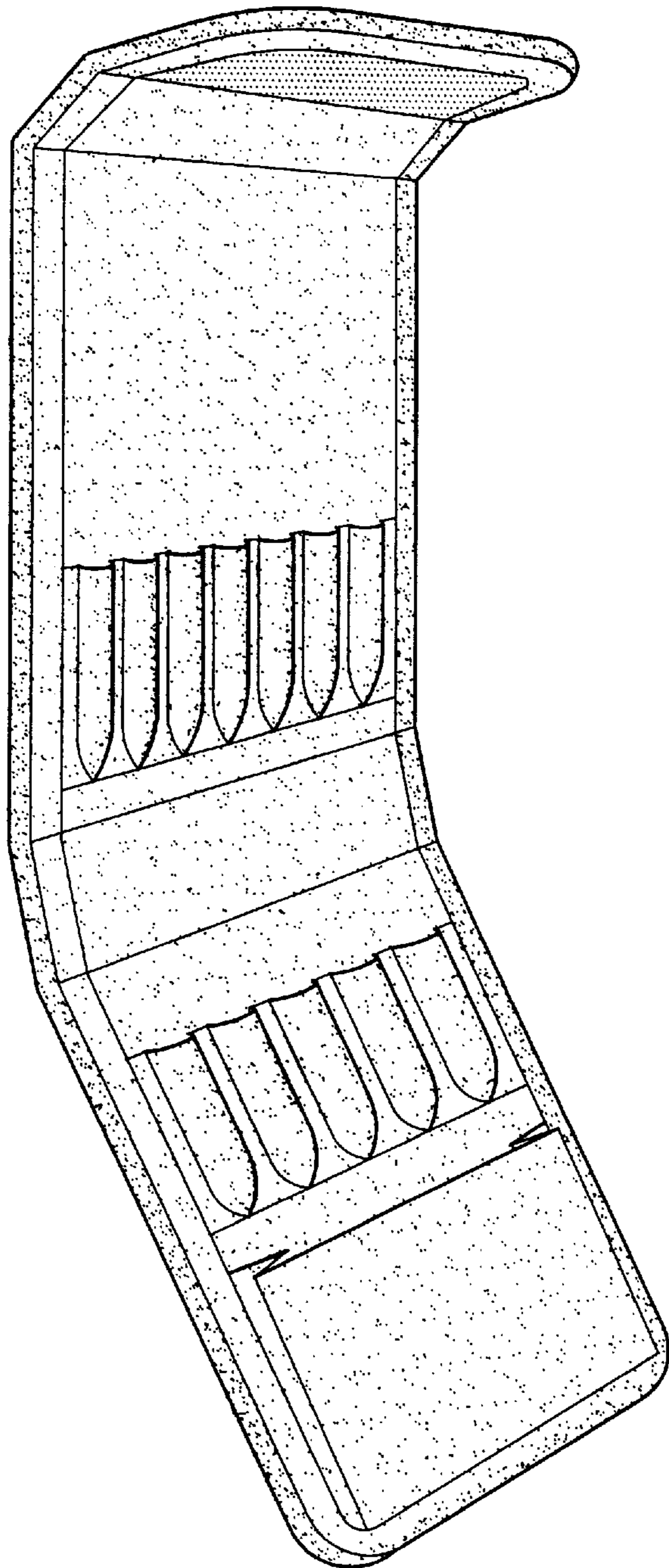

Fig-7

Fig-8

UNITED STATES PATENT AND TRADEMARK OFFICE
CERTIFICATE OF CORRECTION

PATENT NO. : Des. 438,007 S
DATED : February 7, 2001
INVENTOR(S) : Matthew J. Holland et al.

Page 1 of 1

It is certified that error appears in the above-identified patent and that said Letters Patent is hereby corrected as shown below:

Title page,

Item [56], **References Cited**, U.S. PATENT DOCUMENTS, add
-- 5,711,469 1/1998 Gormley et al. --.

Signed and Sealed this

Twenty-fourth Day of December, 2002

A handwritten signature in black ink, appearing to read "James E. Rogan", written over a horizontal line.

JAMES E. ROGAN
Director of the United States Patent and Trademark Office