



US00D437930S

(12) **United States Design Patent**
Gross et al.

(10) **Patent No.:** **US D437,930 S**

(45) **Date of Patent:** **** Feb. 20, 2001**

(54) **DRUG CONVERSION DEVICE**

(75) Inventors: **Joseph Gross**, Moshav Mazor; **Gilad Lavi**, Holon, both of (IL); **Izrail Tsals**, Sudbury, MA (US); **Gil Yigal**, Gan-Yavne (IL)

(73) Assignee: **Elan Corporation, plc**, Dublin (IE)

(**) Term: **14 Years**

(21) Appl. No.: **29/104,854**

(22) Filed: **May 13, 1999**

(51) **LOC (7) Cl.** **24-01**

(52) **U.S. Cl.** **D24/108; D24/133**

(58) **Field of Search** D24/108, 111, D24/128, 127, 133, 112, 113, 114; 604/410, 416, 411, 131, 132, 133, 134, 135, 136, 139, 142, 157, 82, 83, 141; 128/DIG. 12

(56) **References Cited**

U.S. PATENT DOCUMENTS

D. 404,482 * 1/1999 Falk et al. D24/113

4,458,733	*	7/1984	Lyons	604/410
5,267,957	*	12/1993	Kriesel et al.	604/132
5,336,180	*	8/1994	Kriesel et al.	604/131
5,466,220	*	11/1995	Brenneman	604/411
6,030,363	*	2/2000	Kriesel	604/132

* cited by examiner

Primary Examiner—Ian Simmons

(74) *Attorney, Agent, or Firm*—Kathleen Maher Lynch

(57) **CLAIM**

The ornamental design for a drug conversion device, as shown.

DESCRIPTION

FIG. 1 is a perspective view of our new drug conversion device;

FIG. 2 is a front view thereof;

FIG. 3 is a rear view thereof;

FIG. 4 is a right side view thereof;

FIG. 5 is a left side view thereof;

FIG. 6 is a top view thereof; and,

FIG. 7 is a bottom view thereof.

1 Claim, 4 Drawing Sheets

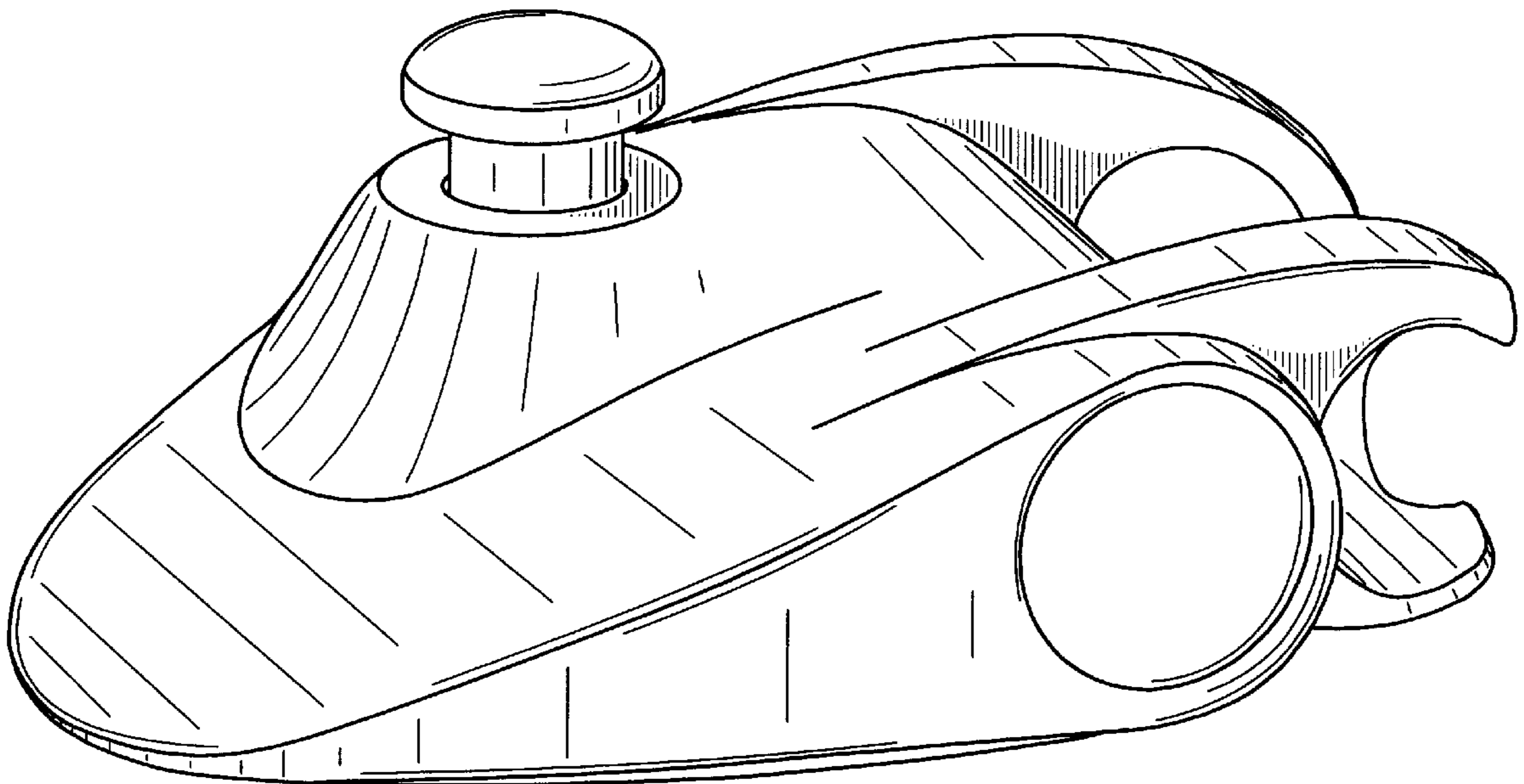

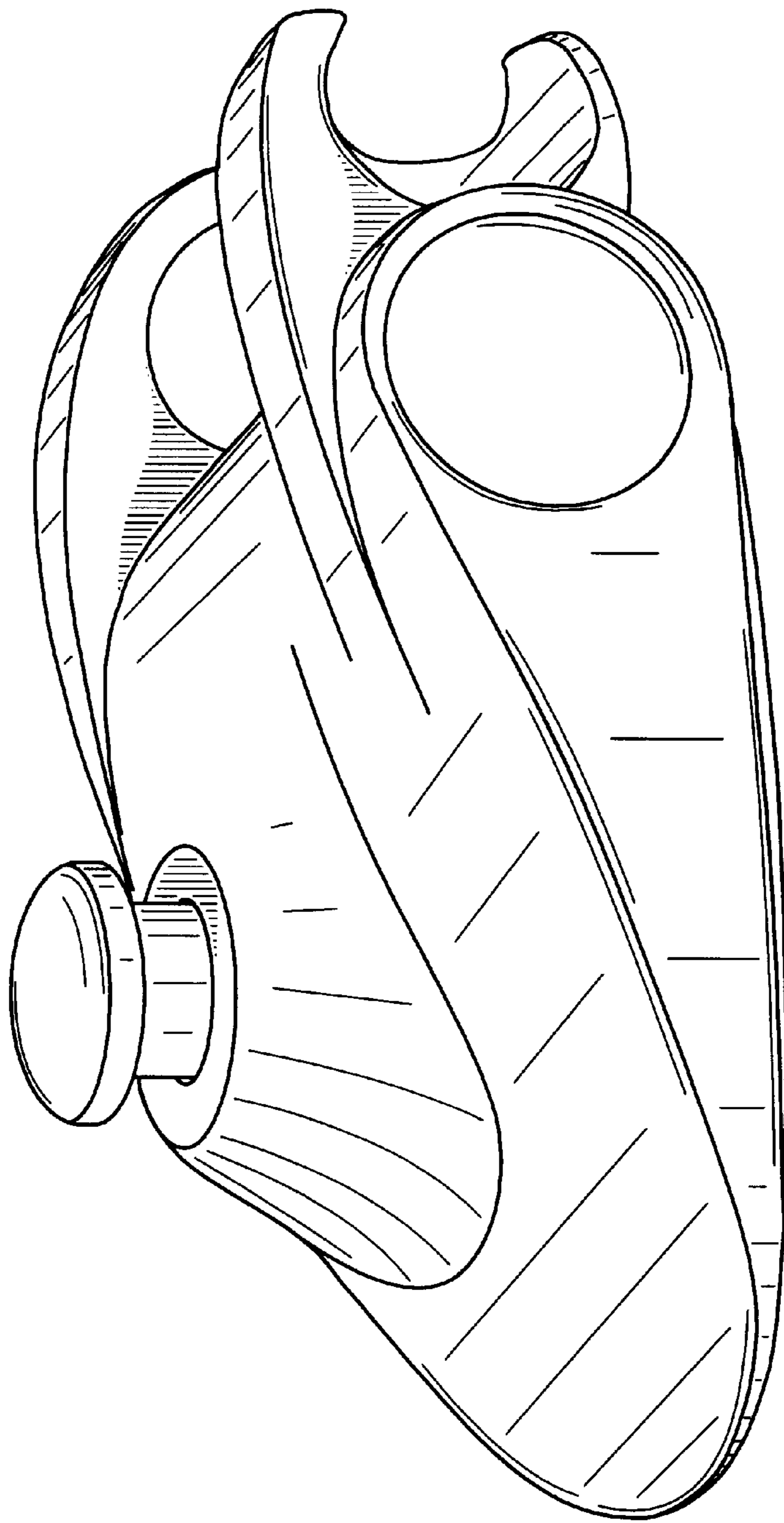

FIG. 1

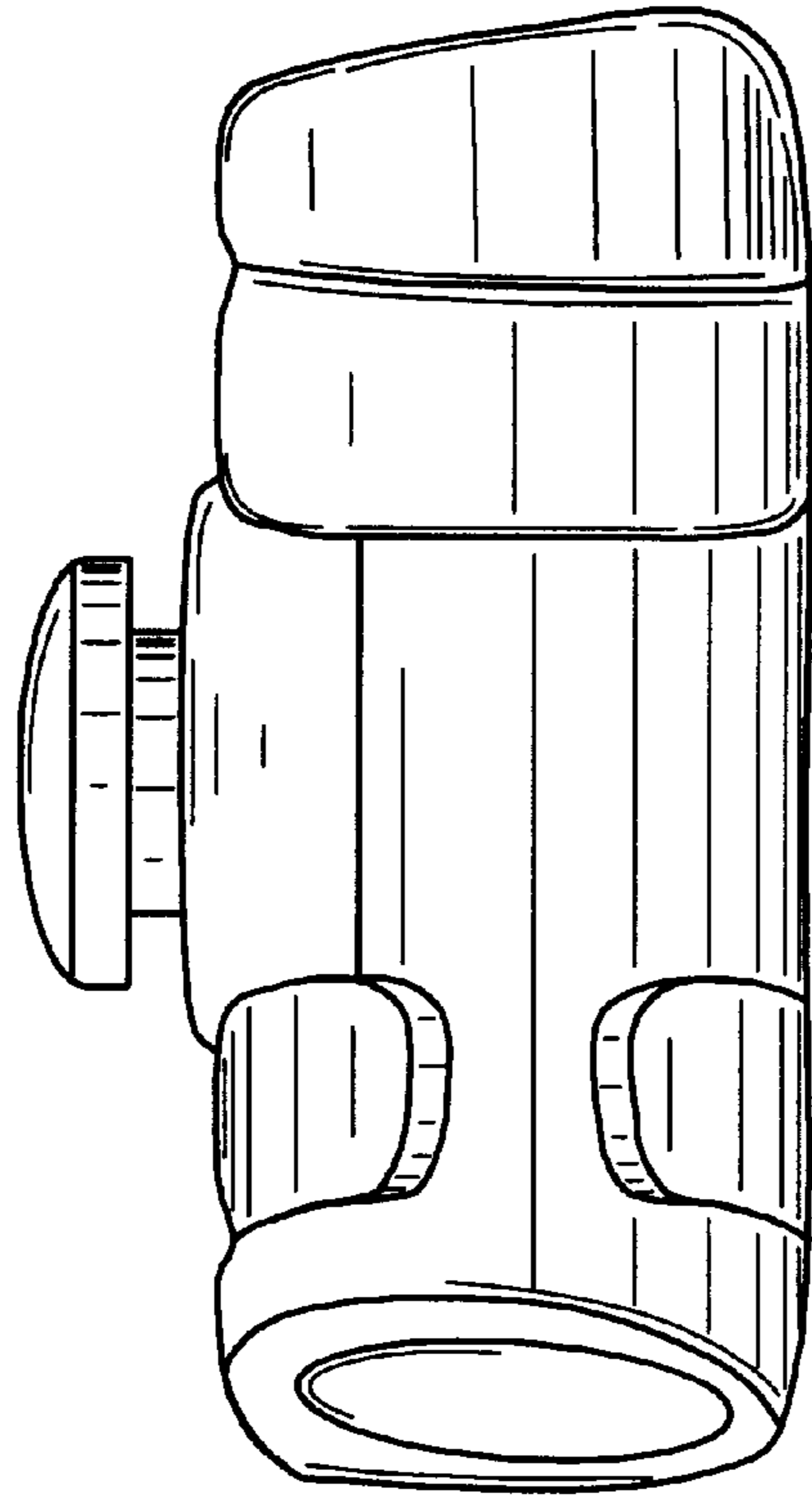

FIG. 3

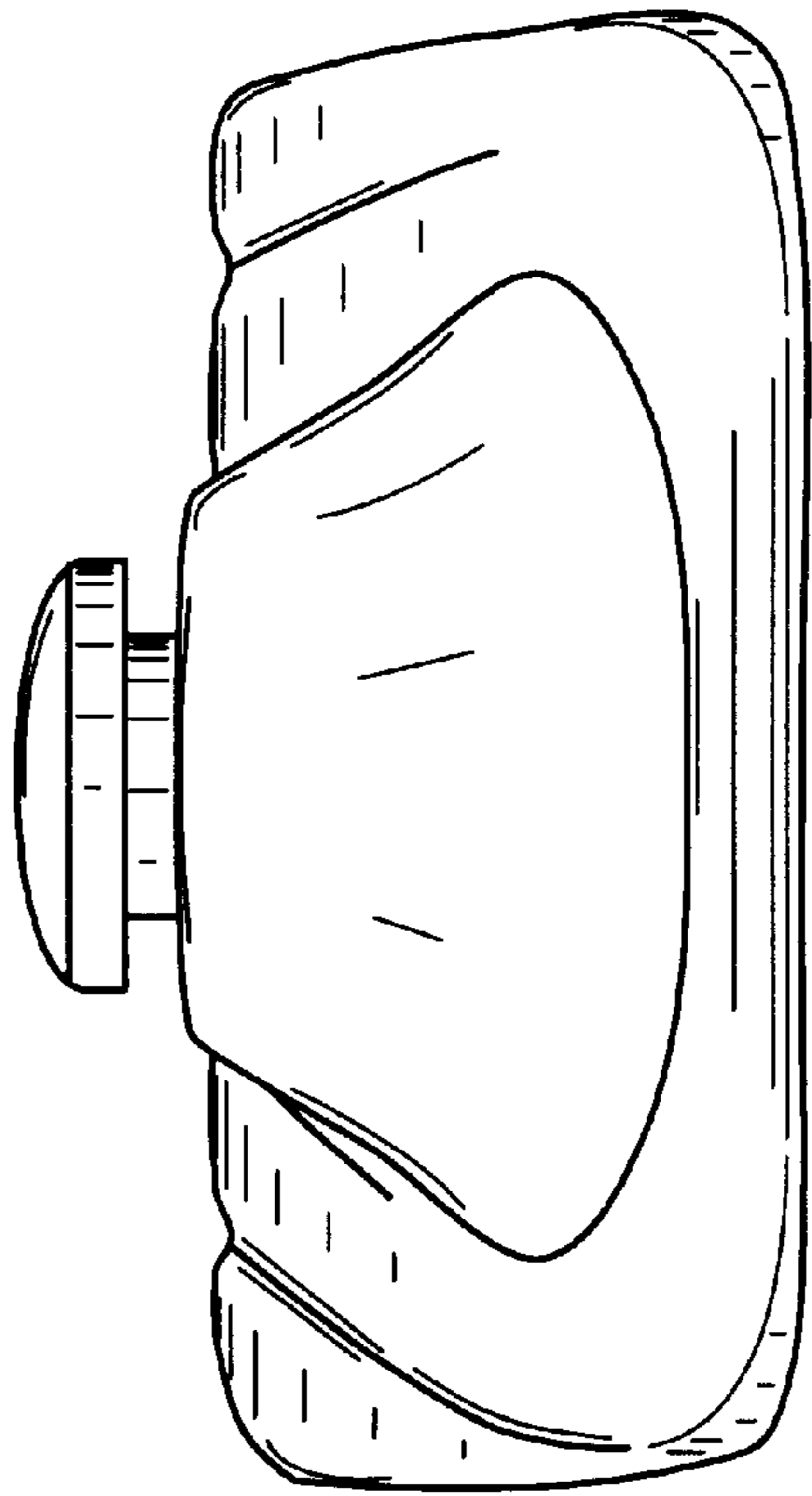

FIG. 2

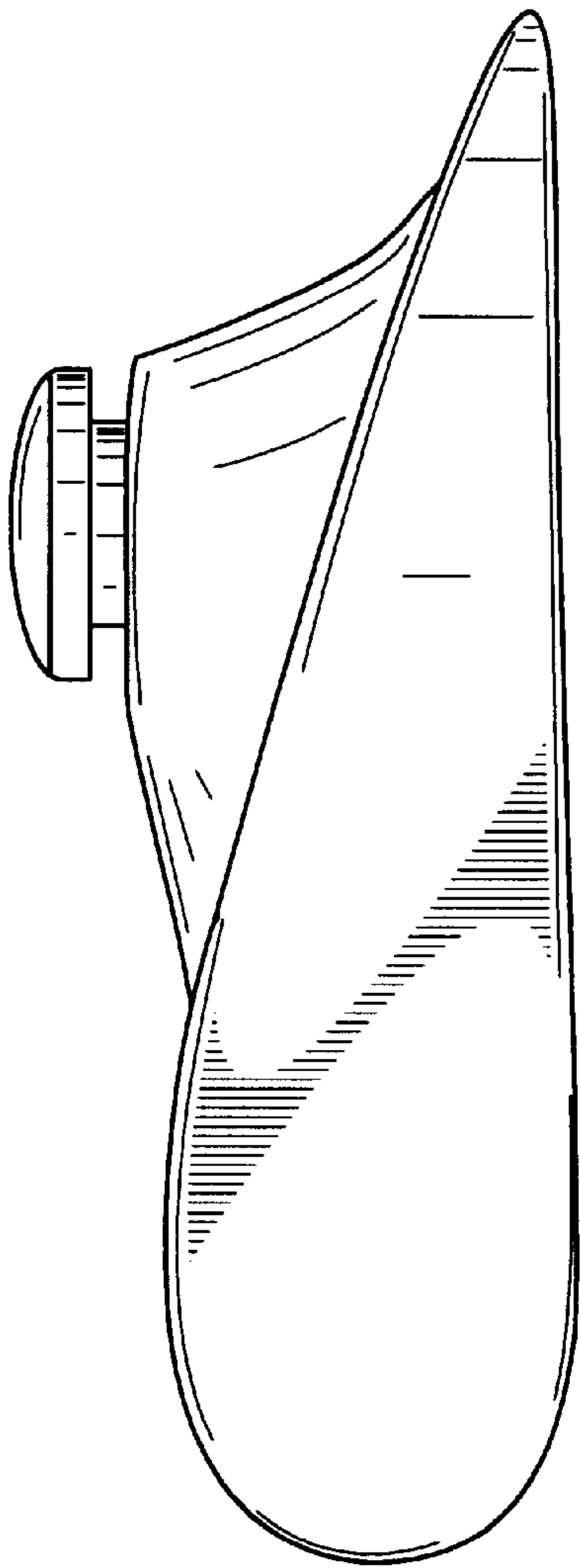

FIG. 4

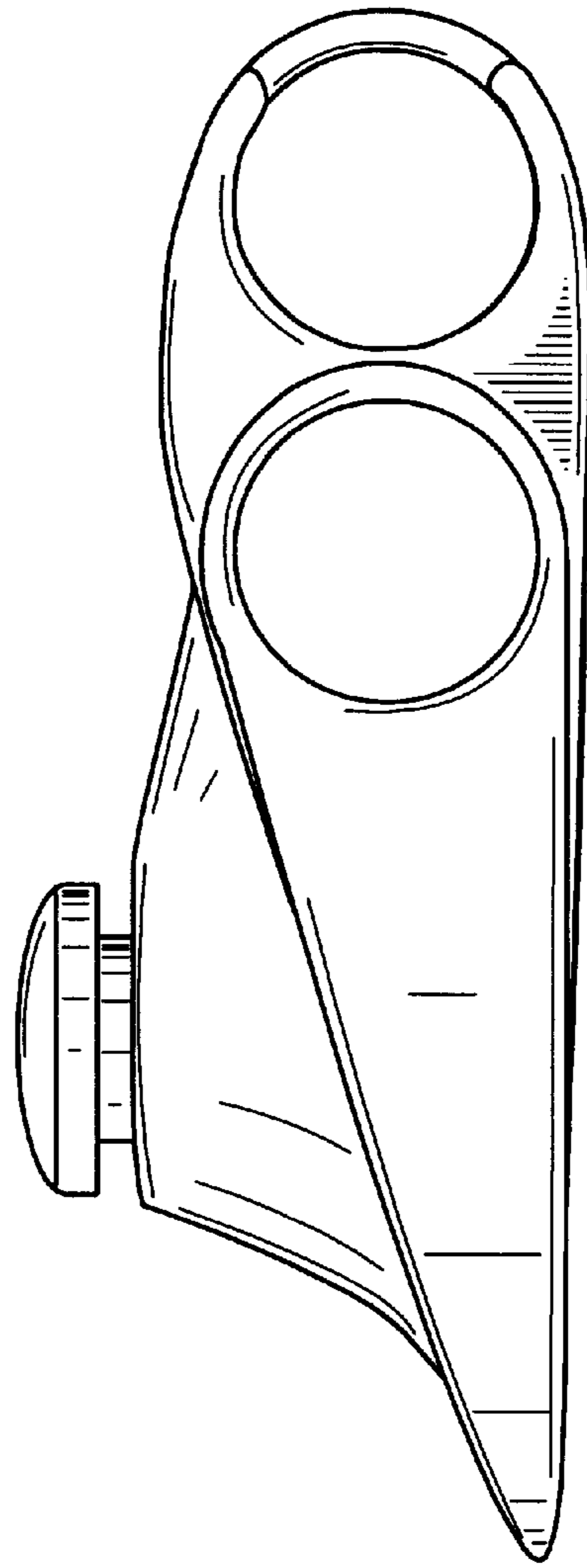

FIG. 5

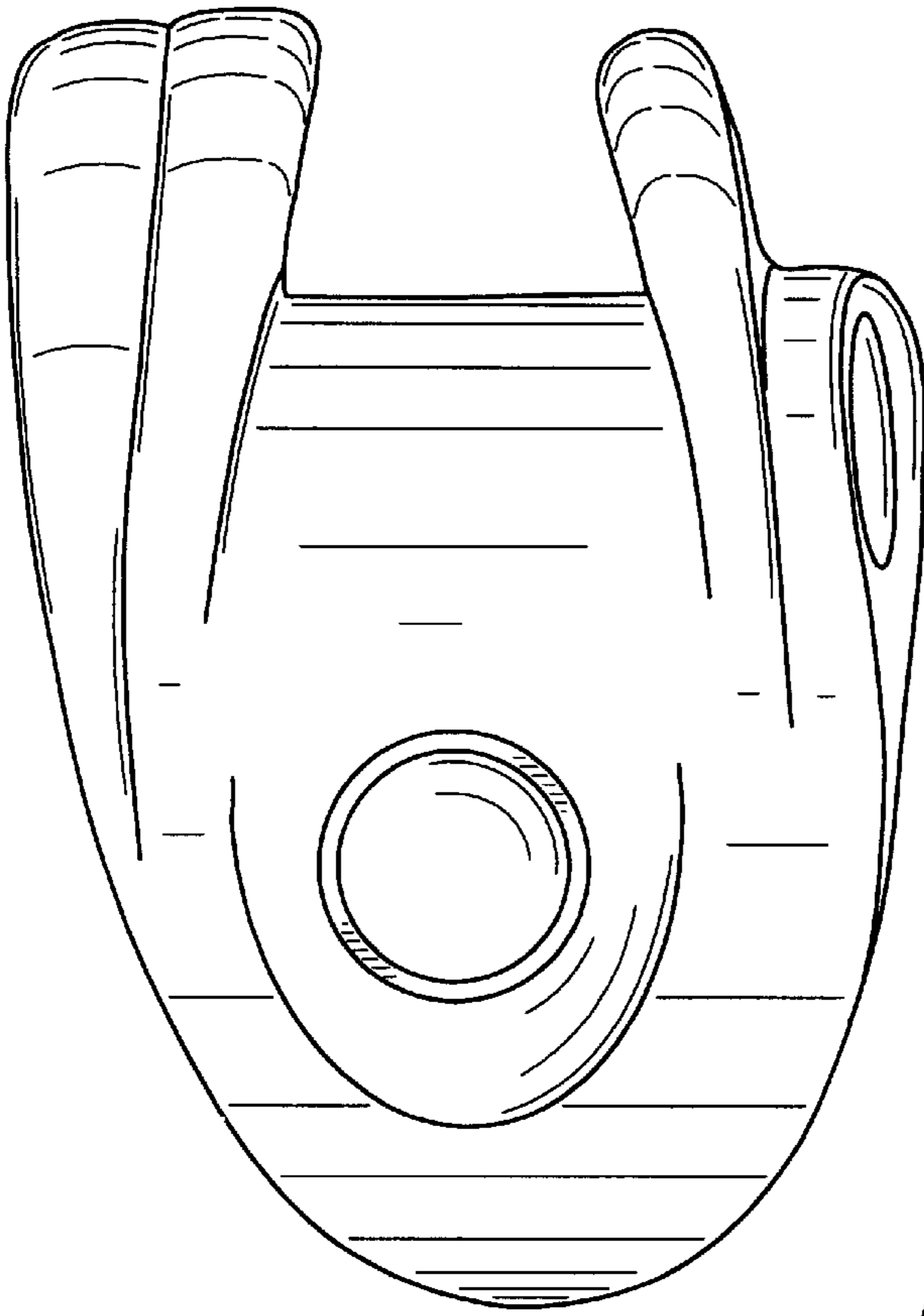

FIG. 6

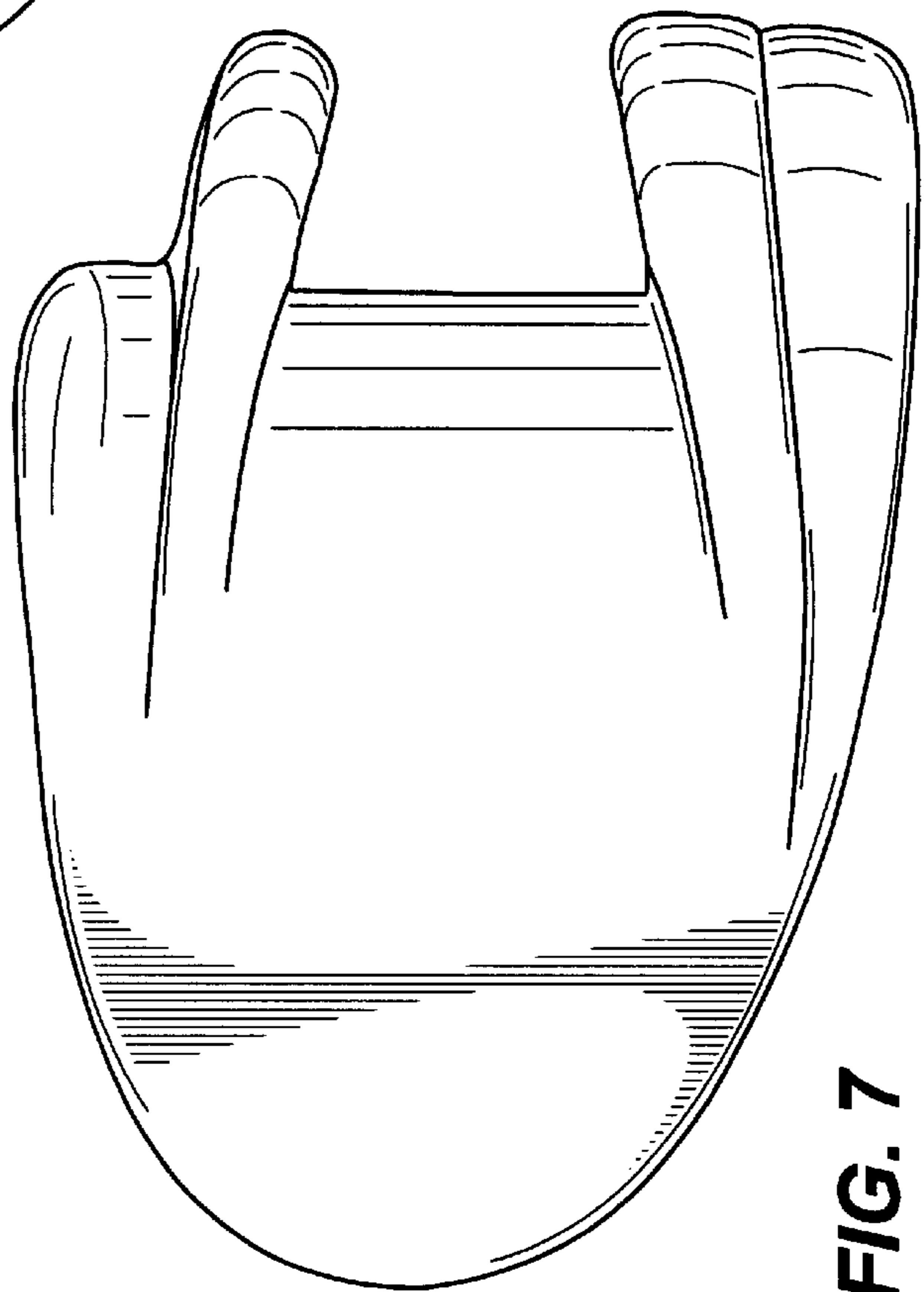

FIG. 7